



**WORK ZONE TRAFFIC CONTROL
PROCEDURES AND GUIDELINES
FOR
SCDOT
MAINTENANCE ACTIVITIES**

February 1, 2019

WORK ZONE TRAFFIC CONTROL PROCEDURES AND GUIDELINES FOR SCDOT MAINTENANCE ACTIVITIES

Table of Contents

<i>Introduction</i>	1
<i>Roadway Characteristics</i>	2
Roadway Types.....	2
Two-Lane Two-Way.....	2
Multilane.....	2
Interstate.....	2
Roadway Speed Classifications.....	2
Low Speed.....	2
Intermediate Speed.....	2
High Speed.....	2
Traffic Volume Classifications.....	2
Low Volume.....	2
“Rule of Thumb” – Determination of a Low Volume.....	2
Intermediate Volume.....	2
High Volume.....	2
<i>Duration of Work</i>	3
Long-Term Stationary.....	3
Intermediate-Term Stationary.....	3
Short-Term Stationary.....	3
Short Duration.....	3
Mobile.....	3
Intermittent.....	3
Continuous.....	3
<i>Temporary Traffic Control Zone</i>	4
Components.....	4
Advance Warning Area.....	4
Transition Area.....	4
Activity Area.....	4
Termination Area.....	4
Tapers.....	5

Traffic Control Devices.....	7
Signs.....	7
Channelizing Devices.....	9
Standard Traffic Cones.....	9
42" Oversized Traffic Cones.....	9
Portable Plastic Drums.....	9
Barricades.....	9
Warning Lights.....	11
Supplemental Warning Lights for Traffic Control Devices.....	11
Auxiliary Warning Lights for Vehicles and Equipment.....	11
 Trailer Mounted Traffic Control Devices.....	 12
Advance Warning Arrow Panels.....	12
Changeable Message Signs.....	13
 Truck Mounted Traffic Control Devices.....	 14
Advance Warning Arrow Panels.....	14
Changeable Message Signs.....	15
Truck Mounted Attenuators.....	16
 Work Vehicles.....	 17
 Daytime and Nighttime Work.....	 18
 Work Zone Traffic Control Procedures.....	 19
Work Zone Setup / Removal.....	19
Flagging Operations on Two-Lane Two-Way Roadways.....	19
Lane Closures on Multilane Roadways.....	19
Mobile Operations.....	19
Flagging Operations.....	19
Single Flagger Flagging Operations.....	20
Multiple Flaggers Flagging Operations.....	20
Approach Taper.....	20
Downstream Taper.....	20
Flagger Station.....	20
Closed Lane Flagger.....	20
Open Lane Flagger.....	20
Side Road Flagger.....	20
Buffer Space.....	20
Work Activity Area.....	20
Limits of the Work Activity Area.....	20
Approach Lane.....	20
Departure Lane.....	20
Mainline Approach.....	21
Side Road(s).....	21
Limits of the Intersection (Physical Area of an Intersection).....	21
Nighttime Flagging Operations.....	21
Buffer Space.....	22
Signs and Traffic Control Devices.....	22
Advance Warning Arrow Panel.....	23
Truck Mounted Attenuator.....	23
Lane Closures.....	24
Shoulder Closures.....	26

Mobilized Shoulder Operations	27
Primary and Secondary Roadways.....	27
Pedestrian Workers.....	27
Equipment / Vehicles.....	28
Interstate Roadways.....	28
Mobile Operations	29
Intermittent Mobile Operations.....	29
Primary and Secondary Routes.....	29
Interstate Routes.....	30
Stopping Sight Distance.....	30
Vehicle Train Requirements.....	31
Single Work Vehicle.....	31
Shadow Vehicle.....	31
Continuous Mobile Operations.....	32
Detours	33
Pacing Operations	34

Typical Work Zone Traffic Control Standard Drawings for Maintenance Operations

Work Zone Signing

<p>Drawing No. 105-01 Advance Construction Signs Portable Sign Supports Installation.....</p>	<p>WZS-1</p>
<p>Drawing No. 105-10 Work Zone Signing Ground Mounted U-Channel Posts Breakaway System Installation.....</p>	<p>WZS-3</p>
<p>Drawing No. 105-20 Work Zone Signing Ground Mounted U-Channel Posts U-Channel Splice.....</p>	<p>WZS-5</p>
<p>Drawing No. 105-30 Work Zone Signing Square Steel Tube Posts 12 Gauge / 14 Gauge Sign Supports 12 Gauge Ground Support Direct Embedment.....</p>	<p>WZS-7</p>
<p>Drawing No. 105-40 Work Zone Signing Square Steel Tube Posts Typical Single Post Installations Sign Panel Square Footage of 14 Square Feet or Less.....</p>	<p>WZS-9</p>
<p>Drawing No. 105-50 Work Zone Signing Square Steel Tube Posts Single Post Installations 12 Gauge Sign Support 7 Gauge Breakaway Anchors Sign Panels Greater Than 14 Square Feet Up to 20 Square Feet.....</p>	<p>WZS-11</p>
<p>Drawing No. 105-60 Work Zone Signing Square Steel Tube Posts Typical Single Post Installations Sign Panels Greater Than 14 Square Feet Up to 20 Square Feet.....</p>	<p>WZS-13</p>

Lane Closure Installation & Removal

<p>Drawing Nos. 305-01-A 305-01-B 305-02 305-03</p> <p>Lane Closure Installation & Removal Multilane Primary & Secondary Routes Interstate Routes.....</p>	<p>LCIR-1 LCIR-1 LCIR-2</p>
<p> Installation.....</p> <p> Removal.....</p>	<p>LCIR-1 LCIR-2</p>

Flagging Operations

Drawing No. 405-01-A	
Flagging Operations	
Multiple Flaggers	
Two-Lane Two-Way Roadways	
Primary & Secondary Routes.....	FO-1
Scenario – Standard Drawing.....	FO-1
Drawing No. 405-01-B(1)	
Flagging Operations	
Multiple Flaggers	
Two-Lane Two-Way Roadways	
Primary & Secondary Routes	
Stop Sign Controlled Side Roads.....	FO-3
Drawing No. 405-01-B(2)	
Flagging Operations	
Multiple Flaggers	
Two-Lane Two-Way Roadways	
Primary & Secondary Routes	
4-Way Stop Controlled Intersection.....	FO-5
Drawing No. 405-01-C(1)	
Flagging Operations	
Multiple Flaggers	
Two-Lane Two-Way Roadways	
Primary & Secondary Routes	
Traffic Signal Controlled Intersection	
Law Enforcement Officer(s).....	FO-7
Drawing No. 405-01-C(2)	
Flagging Operations	
Multiple Flaggers	
Two-Lane Two-Way Roadways	
Primary & Secondary Routes	
Traffic Signal Controlled Intersection	
Flaggers.....	FO-9
Drawing No. 405-01-D(1)	
Flagging Operations	
Multiple Flaggers	
Two-Lane Two-Way Roadways	
Primary & Secondary Routes	
Work Activity Area	
Beginning at an	
Intersection with a	
Two-Lane Two-Way Roadway	
Departure Lane.....	FO-11
Drawing No. 405-01-D(2)	
Flagging Operations	
Multiple Flaggers	
Two-Lane Two-Way Roadways	
Primary & Secondary Routes	
Work Activity Area	
Terminating at an	
Intersection with a	
Two-Lane Two-Way Roadway	
Approach Lane.....	FO-15

Drawing Nos. 405-01-E(1)
Flagging Operations
Multiple Flaggers
Two-Lane Two-Way Roadways
Primary & Secondary Routes
Work Activity Area
Intersections with
Low Speed
< / = 35 MPH
Multilane Roadways..... **FO-18**

Drawing Nos. 405-01-E(2)
Flagging Operations
Multiple Flaggers
Two-Lane Two-Way Roadways
Primary & Secondary Routes
Work Activity Area
Intersections with
Low Speed
< / = 35 MPH
Multilane Roadways..... **FO-20**

Drawing Nos. 405-01-F(1)
Flagging Operations
Multiple Flaggers
Two-Lane Two-Way Roadways
Primary & Secondary Routes
Work Activity Area
Intersections with
Intermediate Speed to High Speed
40 MPH – 60 MPH
Multilane Roadways..... **FO-22**

Drawing Nos. 405-01-F(2)
Flagging Operations
Multiple Flaggers
Two-Lane Two-Way Roadways
Primary & Secondary Routes
Work Activity Area
Intersections with
Intermediate Speed to High Speed
40 MPH – 60 MPH
Multilane Roadways..... **FO-25**

Drawing No. 405-02
Flagging Operations
Single Flagger Operation
Low Volume
Low Speed to Intermediate Speed
Two-Lane Two-Way Roadways
Primary & Secondary Routes..... **FO-27**

Lane Closures
Primary & Secondary Routes

Drawing No. 505-01
Lane Closure
Low Speed Multilane
< / = 35 MPH
Primary & Secondary Routes..... **LCPS-1**

Drawing No. 505-02 Dual Lane Closure Low Speed Multilane < / = 35 MPH Primary & Secondary Routes.....	LCPS-4
Drawing No. 505-03-A Lane Closure Intermediate Speed to High Speed 40 MPH – 60 MPH Multilane Primary & Secondary Routes.....	LCPS-7
Drawing No. 505-03-B Lane Closure Intermediate Speed to High Speed 40 MPH – 60 MPH Exit / Entrance Ramps Multilane Primary & Secondary Routes.....	LCPS-10
Drawing Nos. 505-04-A 505-04-B Dual Lane Closure Intermediate Speed to High Speed 40 MPH – 60 MPH Transition / Activity Areas / Advance Warning Area Multilane Primary & Secondary Routes.....	LCPS-12
Drawing No. 505-04-C Dual Lane Closure Intermediate Speed to High Speed 40 MPH – 60 MPH Exit / Entrance Ramps Multilane Primary & Secondary Routes.....	LCPS-16

**Lane Closures
Interstate Routes**

Drawing No. 510-01-A Lane Closure Interstate Routes.....	LCI-1
Drawing No. 510-01-B Lane Closure Exit / Entrance Ramps Interstate Routes.....	LCI-4
Drawing Nos. 510-02-A 510-02-B Dual Lane Closure Transition / Activity Areas / Advance Warning Area Interstate Routes.....	LCI-6
Drawing No. 510-02-C Dual Lane Closure Exit / Entrance Ramps Interstate Routes.....	LCI-10

Shoulder Closures Primary & Secondary Routes

Drawing No. 515-01-A Right Shoulder Closure (Case I / Case II) Two-Lane Two-Way Roadway Primary & Secondary Routes.....	SCPS-1
Drawing No. 515-01-B Right Shoulder Closure (Case I / Case II) Multilane Primary & Secondary Routes.....	SCPS-3
Drawing No. 515-01-C Right Shoulder Closure Low Speed < / = 35 MPH Primary & Secondary Routes (Minor Encroachment).....	SCPS-5
Drawing No. 515-01-D Left Shoulder Closure Low Speed < / = 35 MPH Multilane Divided Highway with Grassed Earth Median Primary & Secondary Routes (Minor Encroachment).....	SCPS-7
Drawing No. 515-02 Left Shoulder Closure (Case I / Case I) Multilane Primary & Secondary Routes.....	SCPS-9
Drawing No. 515-03 Left Shoulder Closure (Case I / Case II) Multilane Primary & Secondary Routes.....	SCPS-11

Shoulder Closures Interstate Routes

Drawing No. 520-01 Right Shoulder Closure (Case I / Case II) Interstate Routes.....	SCI-1
Drawing No. 520-02 Left Shoulder Closure (Case I / Case I) Narrow Median Interstate Routes.....	SCI-3
Drawing No. 520-03 Left Shoulder Closure (Case I / Case I) Wide Median Interstate Routes.....	SCI-5

Drawing No. 520-04 Left Shoulder Closure (Case I / Case II) Wide Median Interstate Routes.....	SCI-7
Drawing No. 520-05 Left Shoulder Closure (Case II / Case II) Wide Median Interstate Routes.....	SCI-9
Drawing No. 520-06 Gore Area Interstate Routes.....	SCI-11

**Mobilized Shoulder Operations
Primary & Secondary Routes**

Drawing No. 525-01 Mobilized Shoulder Operations Road Machinery – Minor Encroachment Primary & Secondary Routes.....	MSOPS-1
Drawing No. 525-02 Mobilized Shoulder Operations Pedestrian Workers – No Encroachment Road Machinery – Minor Encroachment Primary & Secondary Routes.....	MSOPS-3
Drawing No. 525-03 Mobilized Shoulder Operations Road Machinery – Major Encroachment Primary & Secondary Routes.....	MSOPS-5
Drawing No. 525-04 Mobilized Shoulder Operations Intermediate Speed to High Speed 40 MPH – 60 MPH Pedestrian Workers - Major Encroachment Road Machinery - Major Encroachment Multilane Primary & Secondary Routes.....	MSOP-7

**Mobilized Shoulder Operations
Interstate Routes**

Drawing No. 530-01 Mobilized Shoulder Operations Road Machinery – Major Encroachment Interstate Routes.....	MSOI-1
Drawing No. 530-02 Mobilized Shoulder Operations Pedestrian Workers – Minor Encroachment Upon Paved Shoulder Interstate Routes.....	MSOI-3
Drawing No. 530-03 Mobilized Shoulder Operations Pedestrian Workers – Major Encroachment Upon Paved Shoulder Road Machinery – Major Encroachment Upon Travel Lane Interstate Routes.....	MSOI-5

Mobile Operations Intermittent

Drawing Nos. 535-01-A 535-01-B	
Mobile Operations Intermittent Stopping Sight Distance Vehicle Train Requirements	
Vertical Curve (Hill) / Horizontal Curve (Curve).....	MOI-1
Vehicle Train Requirements.....	MOI-2
Single Work Vehicle.....	MOI-2
Shadow Vehicle.....	MOI-2
 Drawing Nos. 535-02-A 535-02-B	
Mobile Operations Intermittent Low Volume Low Speed / Intermediate Speed to High Speed Primary & Secondary Routes.....	MOI-5
 Drawing Nos. 535-03-A 535-03-B	
Mobile Operations Intermittent Intermediate Volume Low Speed / Intermediate Speed to High Speed Primary & Secondary Routes.....	MOI-8
 Drawing No. 535-04-A	
Mobile Operations Intermittent High Volume Low Speed Primary & Secondary Routes.....	MOI-11
 Drawing No. 535-04-B	
Mobile Operations Intermittent High Volume Low Speed Interior Travel Lane Operations Primary & Secondary Routes.....	MOI-13
 Drawing No. 535-04-C	
Mobile Operations Intermittent High Volume Intermediate Speed to High Speed Primary & Secondary Routes.....	MOI-15
 Drawing No. 535-04-D(1)	
Mobile Operations Intermittent High Volume High Speed Interstate Routes.....	MOI-17
 Drawing No. 535-04-D(2)	
Mobile Operations Intermittent Pedestrian Workers Interstate Routes (Major Encroachment).....	MOI-19

Drawing No. 535-04-E Mobile Operations Intermittent High Volume High Speed Interior Travel Lane Operations Interstate Routes.....	MOI-22
---	--------

**Mobile Operations
Continuous**

Drawing No. 540-01 Mobile Operations Continuous Two-Lane Two-Way Roadways Primary & Secondary Routes.....	MOC-1
---	-------

Drawing Nos. 540-02-A 540-02-B Mobile Operations Continuous Multilane Primary & Secondary Routes Earth Median with Grassed or Paved Shoulders / Paved Median with Curb & Gutter.....	MOC-3
--	-------

Drawing Nos. 540-03-A 540-03-B Mobile Operations Continuous Interstate Routes Right Travel Lane / Left Travel Lane.....	MOC-6
--	-------

Drawing Nos. 540-04-A 540-04-B Mobile Operations Continuous Dual Lane Closures Interior Travel Lane Operations Interstate Routes Right Travel Lanes / Left Travel Lanes.....	MOC-9
---	-------

**Traffic Signal Work Operations
Signal Heads**

Drawing No. 605-01-A Traffic Signal Work Operations Vehicle Train Two-Lane Two-Way Roadway Primary & Secondary Routes Traffic Signal Work Activities Completed in 15 Minutes or Less.....	TSSH-1
--	--------

Drawing No. 605-01-B Traffic Signal Work Operations Vehicle Train Two-Lane Two-Way Roadway Primary & Secondary Routes Traffic Signal Work Activities That Exceed a Time Duration of 15 Minutes.....	TSSH-3
--	--------

Drawing No. 605-02-A Traffic Signal Work Operations Vehicle Train Right Lane Closure Multilane Primary & Secondary Routes Traffic Signal Work Activities Completed in 15 Minutes or Less.....	TSSH-5
Drawing No. 605-02-B Traffic Signal Work Operations Vehicle Train Right Lane Closure Multilane Primary & Secondary Routes Traffic Signal Work Activities That Exceed a Time Duration of 15 Minutes But Not More Than 60 Minutes.....	TSSH-7
Drawing No. 605-03-A Traffic Signal Work Operations Vehicle Train Interior Lane Closure Multilane Primary & Secondary Routes with 2 Through Lanes Traffic Signal Work Activities Completed in 15 Minutes or Less.....	TSSH-9
Drawing No. 605-03-B Traffic Signal Work Operations Vehicle Train Interior Lane Closure Multilane Primary & Secondary Routes with 2 Through Lanes Traffic Signal Work Activities That Exceed a Time Duration of 15 Minutes But Not More Than 60 Minutes.....	TSSH-11
Drawing No. 605-04-A Traffic Signal Work Operations Vehicle Train Interior Lane Closure Multilane Primary & Secondary Routes with 3 or More Through Lanes Traffic Signal Work Activities Completed in 15 Minutes or Less.....	TSSH-13
Drawing No. 605-04-B Traffic Signal Work Operations Vehicle Train Interior Lane Closure Multilane Primary & Secondary Routes with 3 or More Through Lanes Traffic Signal Work Activities That Exceed a Time Duration of 15 Minutes But Not More Than 60 Minutes.....	TSSH-15
Drawing No. 605-05-A(1) Traffic Signal Work Operations Side Street Treatment Dual Left Turn Lanes Work Vehicle – Right Lane Multilane Primary & Secondary Routes Traffic Signal Work Activities Completed in 15 Minutes or Less.....	TSSH-17

Drawing No. 605-05-A(2)
 Traffic Signal Work Operations
 Side Street Treatment
 Dual Left Turn Lanes
 Work Vehicle – Left Lane
 Multilane
 Primary & Secondary Routes
 Traffic Signal Work Activities Completed in 15 Minutes or Less..... TSSH-19

Drawing No. 605-05-B(1)
 Traffic Signal Work Operations
 Side Street Treatment
 Dual Left Turn Lanes
 Work Vehicle – Right Lane
 Multilane
 Primary & Secondary Routes
 Traffic Signal Work Activities That Exceed a Time Duration of 15 Minutes
 But Not More Than 60 Minutes..... TSSH-21

Drawing No. 605-05-B(2)
 Traffic Signal Work Operations
 Side Street Treatment
 Dual Left Turn Lanes
 Work Vehicle – Left Lane
 Multilane
 Primary & Secondary Routes
 Traffic Signal Work Activities That Exceed a Time Duration of 15 Minutes
 But Not More Than 60 Minutes..... TSSH-23

**Traffic Signal Work Operations
 Loops**

Drawing No. 606-01
 Traffic Signal Work Operations
 Vehicle Train
 Two-Lane Two-Way Roadway
 Primary & Secondary Routes
 Traffic Signal Detection Loop Installation
 Stop Bar Loops..... TSL-1

Drawing No. 606-02
 Traffic Signal Work Operations
 Vehicle Train
 Two-Lane Two-Way Roadway
 Primary & Secondary Routes
 Traffic Signal Detection Loop Installation
 Set Back Loops..... TSL-3

Drawing No. 606-03
 Traffic Signal Work Operations
 Vehicle Train
 Right Lane Closure
 Multilane
 Primary & Secondary Routes
 Traffic Signal Detection Loop Installation
 Stop Bar Loops..... TSL-5

Drawing No. 606-04-A
 Traffic Signal Work Operations
 Vehicle Train
 Interior Lane Closure
 Multilane
 Primary & Secondary Routes with 2 Through Lanes
 Traffic Signal Detection Loop Installation
 Stop Bar Loops..... TSL-7

Drawing No. 606-04-B
 Traffic Signal Work Operations
 Vehicle Train
 Interior Lane Closure
 Multilane
 Primary & Secondary Routes with 2 Through Lanes
 Connecting The Stop Bar Loop to The Pull Box..... TSL-9

Drawing No. 606-05-A
 Traffic Signal Work Operations
 Vehicle Train
 Interior Lane Closure
 Multilane
 Primary & Secondary Routes with 3 or More Through Lanes
 Traffic Signal Detection Loop Installation
 Stop Bar Loops..... TSL-11

Drawing No. 606-05-B
 Traffic Signal Work Operations
 Vehicle Train
 Interior Lane Closure
 Multilane
 Primary & Secondary Routes with 3 or More Through Lanes
 Connecting The Stop Bar Loop to The Pull Box..... TSL-13

Drawing No. 606-06
 Traffic Signal Work Operations
 Vehicle Train
 Right Lane Closure
 Multilane
 Primary & Secondary Routes with 2 Through Lanes
 Traffic Signal Detection Loop Installation
 Set Back Loops..... TSL-15

Drawing No. 606-07
 Traffic Signal Work Operations
 Vehicle Train
 Right Lane Closure
 Multilane
 Primary & Secondary Routes with 3 or More Through Lanes
 Traffic Signal Detection Loop Installation
 Set Back Loops..... TSL-17

**Pavement Marking Application
 Operations**

Drawing No. 610-01
 Pavement Marking Application
 Intersections
 Vehicle Train
 Two-Lane Two-Way Roadway
 Primary & Secondary Routes..... PMO-1

Drawing No. 610-02
Pavement Marking Application
Intersections
Vehicle Train
Right Lane Closure
Multilane..... **PMO-3**

Drawing No. 610-03
Pavement Marking Application
Intersections
Vehicle Train
Interior Lane Closure
Multilane
2 Through Lanes..... **PMO-5**

Drawing No. 610-04
Pavement Marking Application
Intersections
Vehicle Train
Interior Lane Closure
Multilane
2 or More Through Lanes..... **PMO-7**

**Extended
Road Closures**

Drawing No. 705-01
Extended Road Closure of Roadway..... **ERC-1**

Drawing No. 705-02
Extended Road Closure for Bridge Work..... **ERC-3**

Detour Signing

Drawing No. 805-01
Detour Signing for Primary and Interstate Routes..... **DS-1**

Drawing No. 805-02
Detour Signing for Secondary Routes..... **DS-3**

Traffic Control Requirements for Specific Maintenance Performance Activities

Performance Activity 102 Surface Repairs

102	Surface Repairs.....		102-1
	Work Description 1	Patching / Minor Leveling.....	102-1
	Work Description 2	Major Leveling / Strengthening.....	102-6
	Work Description 3	Resurface.....	102-8

Performance Activity 107 Chip Seal

107	Chip Seal.....		107-1
	Work Description 1	Single.....	107-1
	Work Description 2	Double.....	107-1
	Work Description 3	Triple.....	107-1

Performance Activity 108 Milling

108	Milling.....		108-1
-----	--------------	--	-------

Performance Activity 110 Base Repair

110	Base Repair.....		110-1
	Work Description 1	Full Depth Asphalt.....	110-1
	Work Description 2	Full Depth Concrete.....	110-1
	Work Description 3	Reclamation.....	110-4

Performance Activity 120 Crack Seal Pavement

120	Crack Seal Pavement.....		120-1
	Work Description 1	Asphalt.....	120-1
	Work Description 2	Concrete.....	120-1

Performance Activity 130 Earth Roads

130	Earth Roads.....		130-1
	Work Description 1	Machining Earth Roads.....	130-1
	Work Description 2	Dust Control.....	130-1

Performance Activity 202 Slopes

202	Slopes.....		202-1
	Work Description 1	Repair.....	202-1
	Work Description 2	Install / Maintain.....	202-1

**Performance Activity 203
Shoulders / Ditches**

203	Shoulders / Ditches.....	203-1
	Work Description 1 Clean Outfall.....	203-1
	Work Description 2 Construct Outfall.....	203-1
	Work Description 3 Regrade Roadside Ditch.....	203-5
	Work Description 4 Regrade / Repair Shoulder.....	203-5
	Work Description 5 Regrade Shoulder and Ditch.....	203-5
	Work Description 6 Widen Shoulder.....	203-5

**Performance Activity 204
Construction / Paving**

204	Construction / Paving.....	204-1
	Work Description 1 Pavement Widening / Turn Lanes.....	204-1
	Work Description 2 Shoulder Paving.....	204-1
	Work Description 3 Median Paving (Crossover).....	204-1

**Performance Activity 305
Drainage Structures**

305	Drainage Structures.....	305-1
	Work Description 1 Repair.....	305-1
	Work Description 2 Install.....	305-1
	Work Description 3 Upgrade.....	305-1
	Work Description 4 Clean.....	305-1

**Performance Activity 306
Drainage Pipe**

306	Drainage Pipe.....	306-1
	Work Description 1 Repair.....	306-1
	Work Description 2 Install.....	306-1
	Work Description 3 Remove.....	306-1
	Work Description 4 Clean.....	306-1

**Performance Activity 401
Mowing**

401	Mowing.....	401-1
	Work Description 1 Brush Management.....	401-1
	Work Description 2 Hand Trimming.....	401-1
	Work Description 3 Outdoor Advertising Window.....	401-1
	Work Description 5 Safety.....	401-1
	Work Description 4 Routine.....	401-6

**Performance Activity 402
Herbicide Application**

402	Herbicide.....	402-1
	Work Description 1 Total Vegetation Control.....	402-1
	Work Description 2 Brush.....	402-1
	Work Description 3 Trees.....	402-1
	Work Description 4 Broadleaf Weeds.....	402-1
	Work Description 5 Grassy Weeds.....	402-1
	Work Description 6 Turf.....	402-1

**Performance Activity 403
Grassing**

403	Grassing.....	403-1
-----	---------------	-------

**Performance Activity 405
Limb Management**

405	Limb Management.....	405-1
-----	----------------------	-------

**Performance Activity 406
Beautification**

406	Beautification.....	406-1
-----	---------------------	-------

**Performance Activity 407
Litter Control**

407	Litter Control.....	407-1
	Work Description 1 Litter.....	407-1
	Work Description 2 Dead Animals.....	407-4
	Work Description 3 Litter Bag Pickup.....	407-7

**Performance Activity 408
Tree Removal**

408	Tree Removal.....	408-1
	Work Description 1 Fallen Tree.....	408-1
	Work Description 2 Standing Tree.....	408-1

**Performance Activity 409
Debris Removal**

409	Debris Removal.....	409-1
	Work Description 1 Vegetation.....	409-1
	Work Description 2 Construction / Demolition.....	409-1
	Work Description 3 Personal Property / Household Items.....	409-1
	Work Description 4 White Goods.....	409-1
	Work Description 5 Soil, Mud, Sand.....	409-1
	Work Description 6 Vehicles / Vessels.....	409-1
	Work Description 7 Hazardous Waste.....	409-5

**Performance Activity 410
Roadway Cleaning**

410	Roadway Cleaning.....	410-1
	Work Description 1 Clean by Hand.....	410-1
	Work Description 2 Clean by Machine.....	410-5

**Performance Activity 501
Driveways**

501	Driveways.....	501-1
	Work Description 1 Install.....	501-1
	Work Description 2 Remove.....	501-1
	Work Description 3 Maintenance.....	501-1

**Performance Activity 504
Concrete Structures**

504	Concrete Structures.....	504-1
	Work Description 1 Curb Ramp - Install.....	504-1
	Work Description 2 Sidewalk – Repair.....	504-1
	Work Description 3 Install.....	504-1
	Work Description 4 Repair.....	504-1
	Work Description 5 Remove.....	504-1

**Performance Activity 603
Signs**

603	Signs.....	603-1
	Work Description 3 New Install.....	603-1
	Work Description 4 Maintenance / Replace.....	603-1
	Work Description 6 Temporary.....	603-1

**Performance Activity 604
Traffic Signal**

604	Traffic Signal.....	604-1
	Work Description 1 Trouble Call.....	604-1
	Work Description 2 Rebuild.....	604-1
	Work Description 3 Install.....	604-1
	Work Description 4 Revise.....	604-1
	Work Description 5 Repair.....	604-1
	Work Description 6 Preventative Maintenance Inspection.....	604-1
	Work Description 7 Contract Inspection.....	604-1

**Performance Activity 605
Flashers**

605	Flashers.....	605-1
	Work Description 1 Trouble Call.....	605-1
	Work Description 2 Rebuild.....	605-1
	Work Description 3 Install.....	605-1
	Work Description 4 Revise.....	605-1
	Work Description 5 Repair.....	605-1
	Work Description 6 Preventative Maintenance Inspection.....	605-1
	Work Description 7 Contract Inspection.....	605-1
	Shoulder - Structure Mounted	605-1
	Overhead - Span Wire Mounted	605-6

**Performance Activity 606
Pavement Striping**

606	Pavement Striping.....	606-1
	Work Description 1 New Install / Revise.....	606-1
	Work Description 2 Remove.....	606-1
	Work Description 3 Replace.....	606-1

**Performance Activity 607
Hand Placed Markings**

607	Hand Placed Markings.....	607-1
	Work Description 1 New Install / Revise.....	607-1
	Work Description 2 Remove.....	607-1
	Work Description 3 Replace.....	607-1

**Performance Activity 610
Guardrail**

610	Guardrail.....		610-1
	Work Description 1	Repair.....	610-1
	Work Description 2	Install.....	610-1
	Work Description 3	Remove.....	610-1

**Performance Activity 611
Walls / Fences**

611	Walls / Fences.....		611-1
	Work Description 1	Repair.....	611-1
	Work Description 2	Install.....	611-1
	Work Description 3	Remove.....	611-1

**Performance Activity 613
Impact Attenuator**

613	Impact Attenuator.....		613-1
	Work Description 1	Install.....	613-1
	Work Description 2	Remove.....	613-1
	Work Description 3	Repair.....	613-1

**Performance Activity 614
Highway Lighting**

614	Highway Lighting.....		614-1
	Work Description 1	Install.....	614-1
	Work Description 2	Repair.....	614-1
	Work Description 3	Inspection.....	614-1

**Performance Activity 701
Hazardous Conditions**

701	Hazardous Conditions.....		701-1
	Work Description 1	Winter Weather Operations.....	701-1
	Work Description 3	Preparation.....	701-1
	Work Description 4	Roadway Clearing.....	701-2
	Work Description 2	Spill Response.....	701-5

**Performance Activity 800
Bridge Construction**

800	Bridge Construction.....		800-1
	Work Description 1	Rebuild Existing.....	800-1
	Work Description 2	Replace.....	800-1

**Performance Activity 801
Deck Repair**

801	Deck Repair.....		801-1
	Work Description 1	Concrete Deck Repair.....	801-1
	Work Description 2	Non-Concrete Repair.....	801-1

**Performance Activity 802
Bridge Rail Repair**

802	Bridge Rail Repair.....	801-1
-----	-------------------------	-------

**Performance Activity 803
Superstructure Element**

803	Superstructure Element.....	803-1
	Work Description 1 Beams.....	803-1
	Work Description 2 Floor Beams.....	803-1
	Work Description 3 Stringers.....	803-1
	Work Description 4 Truss Chords.....	803-1

**Performance Activity 805
Bridge Expansion Joints**

805	Bridge Expansion Joints.....	805-1
	Work Description 1 Compression Seal.....	805-1
	Work Description 2 Cold Poured Seal.....	805-1

**Performance Activity 806
Bearing and Saddles**

806	Bearing and Saddles.....	806-1
	Work Description 1 Repair Elastomeric Bearing.....	806-1
	Work Description 2 Replace Elastomeric Bearing.....	806-1
	Work Description 3 Repair Steel Bearing Assembly.....	806-1
	Work Description 4 Replace Steel Bearing Assembly.....	806-1
	Work Description 5 Steel Saddle – Individual.....	806-1
	Work Description 6 Steel Saddle – Continuous.....	806-1

**Performance Activity 807
Bridge Maintenance**

807	Bridge Maintenance.....	807-1
	Work Description 1 Debris Removal.....	807-1
	Work Description 2 Electrical Repair / Inspection.....	807-1
	Work Description 3 Mechanical Repair.....	807-1
	Work Description 4 Scour Remediation.....	807-1
	Work Description 5 Clean Weep Holes.....	807-1
	Work Description 6 Clean Bearing Assemblies / Caps.....	807-1
	Work Description 7 Fender Repair.....	807-1

**Performance Activity 809
Bridge Piles and Caps**

809	Bridge Piles and Caps.....	809-1
	Work Description 1 Cap Repair.....	809-1
	Work Description 2 Cap Replacement.....	809-1
	Work Description 3 Pile Repair.....	809-1
	Work Description 4 Pile Replacement.....	809-1

**Performance Activity 815
Bridge Inspection**

815	Bridge Inspection.....	815-1
	Work Description 1 Bridge Inspection.....	815-1
	Work Description 2 Overhead Sign Inspection.....	815-1

Tables

Table 1. Formulas for Determining Taper Lengths..... 5

Table 2. Taper Types and Taper Length Criteria..... 6

Table 3. Advance Warning Sign Placement Intervals for a Typical 3 Advance Warning Sign Array..... 8

Table 4. Traffic Control Channelizing Device Applications..... 10

Table 5. Advance Warning Arrow Panels (Trailer Mounted)..... 12

Table 6. Advance Warning Arrow Panels (Truck Mounted)..... 14

Table 7. Work Area Illumination Requirements..... 18

Table 8. Traffic Stopped Time Durations for Flagging Operations..... 19

Table 9. Minimum Distance Requirements for a Buffer Space in a Flagging Operation 22

Table 10. Traffic Control Device Spacing Intervals for Flagging Operations..... 23

Table 11. Stopping Sight Distance..... 30

Table 12. Departure Lane from the Intersection
Minimum Distance Intervals from Intersection Required for Conversion to Standard Multiple Flagger Flagging Operation Installation per Drawing No. 405-01-D(1)..... FO-12

Table 13. Approach Lane to the Intersection
Minimum Distance Intervals from Intersection Required for Conversion from a Standard Multiple Flagger Flagging Operation Installation per Drawing No. 405-01-D(2)..... FO-16

Table 14. Advance Warning Sign Placement Intervals for Single Flagger Operations (Drawing No. 405-02)..... FO-27

Table 15. Shadow Vehicle / Work Vehicle Distance Intervals..... MOI-1

Table 16. Traffic Control Devices Quantities for Extended Road Closure of Roadway (Single Approach) (Drawing No. 705-01)..... ERC-1

Table 17. Traffic Control Devices Quantities for Extended Road Closure - Bridge Work (Single Approach) (Drawing No. 705-02)..... ERC-3

Table 18. Detour Sign Assembly Guidelines for Lateral Location (Primary and Interstate Routes) (Drawing No. 805-01)..... DS-1

Table 19. Detour Sign Assembly Guidelines for Lateral Location (Secondary Routes) (Drawing No. 805-02)..... DS-3

INTRODUCTION

The ***Work Zone Traffic Control Procedures and Guidelines For SCDOT Maintenance Activities*** manual complies with the requirements of Part 6 of the *Manual on Uniform Traffic Control Devices* (MUTCD) and policies and procedures of the South Carolina Department of Transportation (SCDOT). This manual provides procedures and guidelines for implementation and maintenance of work zone traffic control installations and operations for South Carolina Department of Transportation maintenance forces. This manual has been developed and designed to assist the SCDOT maintenance forces in the performance of their duties.

In addition to the requirements of this manual, all work zone traffic control installations and operations shall also comply with the latest editions of the following documents:

1. Rule on Work Zone Safety and Mobility: The Policy for South Carolina Department of Transportation
2. Rule on Work Zone Safety and Mobility: Implementation, Maintenance, and Safety Guidelines
3. South Carolina Department of Transportation Engineering Directive Memorandum No. 19, Manual on Uniform Traffic Control Devices
4. South Carolina Department of Transportation Engineering Directive Memorandum No. 32, Hourly Restrictions for Lane Closures on Interstate and Primary Routes
5. South Carolina Flagger's Handbook

The typical work zone traffic control drawings included in this manual illustrate work zone traffic control applications specifically designed for implementation during performance of typical highway maintenance activities conducted by SCDOT maintenance forces. These work zone traffic control drawings incorporate specific requirements based upon duration of work, roadway types, roadway speed classifications and traffic volume classifications.

To facilitate selection of a specific work zone traffic control setup complementary to a specific maintenance activity, a brief description and explanation of the work zone traffic control requirements for each maintenance activity dependent upon site conditions along with a listing of the typical work zone traffic control drawings that may be applicable are provided.

ROADWAY CHARACTERISTICS

The appropriate traffic control requirements are determined by the characteristics of the roadway and the traffic conditions where the work is to be conducted.

ROADWAY TYPES

Two-Lane Two-Way – A typical secondary or primary road with two opposing travel lanes. These roads occur in rural and urban areas. Most of these roads have pavement markings but low volume roadways may not. The travel lanes of a two-lane two-way road are typically separated by double yellow center lines, with or without passing zones, and supplemented with bi-directional yellow retroreflective pavement markers, however, some two-lane two-way roads may be separated by a paved or grassed earth median. The shoulder areas of these roads may be grassed earth, paved or have curb and gutter. Two-lane two-way roads may be low speed roads with posted speed limits of 35 mph or less, intermediate speed roads with posted speed limits of 40 mph to 50 mph or high speed roads with posted speed limits of 55 mph.

Multilane – A typical secondary or primary roads with three or more travel lanes. These roads occur in rural and urban areas. The opposing travel lanes may be separated by double yellow center lines, paved medians, raised concrete islands, concrete median barrier walls, guardrails or grassed earth medians. The shoulder areas of these roadways may be grassed earth, paved or have curb and gutter. Multilane roads may be low speed roads with posted speed limits of 35 mph or less, intermediate speed roads with posted speed limits of 40 mph to 50 mph or high speed roads with posted speed limits of 55 mph or greater.

Interstate – Interstate roads are free flowing access controlled freeways with four or more travel lanes. These roads occur in rural and urban areas. The opposing travel lanes may be separated by grassed earth medians or concrete median barrier walls. The immediate shoulder areas of these roads are paved. Interstate roads are high speed roads with posted speed limits of 55 mph to 70 mph. Intersections with crossing routes are grade separated interchanges.

ROADWAY SPEED CLASSIFICATIONS

Low Speed – A low speed road has a posted regulatory speed limit of 35 MPH or less.

Intermediate Speed – An intermediate speed road has a posted regulatory speed limit of 40 MPH to 50 MPH.

High Speed – A high speed road has a posted regulatory speed limit of 55 MPH or greater.

TRAFFIC VOLUME CLASSIFICATIONS

Low Volume – A low-volume road has an average daily traffic volume (ADT) that does not exceed 400 vehicles per day. If the traffic volumes are not known, the following rule of thumb may be used.

“Rule of Thumb” - Determination of a Low Volume Roadway – Count all vehicles that pass a single reference point over a five (5) minute period. If not more than 5 vehicles pass a single reference point in a five (5) minute period, then consider the road low volume.

Intermediate Volume – An intermediate volume road has an average daily traffic volume (ADT) that ranges from greater than 400 to 10,000 vehicles per day.

High Volume – A high volume road has an average daily traffic volume (ADT) that exceeds 10,000 vehicles per day.

DURATION OF WORK

Work duration is a major factor in determining the number and types of traffic control devices used in temporary traffic control work zones. The various work durations are defined below. Also, the type of channelizing devices required for each work duration scenario is provided.

Long-Term Stationary – Work operations that occupy a location more than 3 days. These work operations extend into the hours of darkness; therefore, channelizing devices designated for use during the hours of darkness are required. See *Table 4*.

Intermediate-Term Stationary – Work operations that occupy a location from 12 hours to 3 days. The shortest work period of 12 hours will extend into the hours of darkness during the shorter days of the year; therefore, channelizing devices designated for use during hours of darkness are required during these work operations. See *Table 4*.

Short-Term Stationary – Daytime work operations that occupy a location from 1 to 12 hours. During work periods that will not extend into the hours of darkness, channelizing devices designated for daytime hours are acceptable. However, longer work periods during the shorter days of the year may encroach into the hours of darkness, therefore, under these conditions implement the requirements for Intermediate-Term Stationary work operations. See *Table 4*.

Short Duration – Work operations that occupy a location up to 1 hour. Due to the short time duration of the work, channelizing devices may not be required during Short Duration work operations. However, all work zone traffic control setups should comply with the requirements of the typical work zone traffic control standard drawings for maintenance operations. Amber colored high intensity rotating, flashing, oscillating or strobe lights are required on the vehicles operating in the work zone. Warning signs, truck mounted arrow panels, truck mounted changeable message signs and truck mounted attenuators may also be required to supplement these vehicles.

Mobile – Work operations that move intermittently or continuously. Channelizing devices may be used but are not required during Mobile Operations. Amber colored high intensity rotating, flashing, oscillating or strobe lights are required on the work vehicles. Warning signs, truck mounted arrow panels, truck mounted changeable message signs and truck mounted attenuators may also be required to supplement the vehicles operating in the vehicle train.

Intermittent – Mobile Operations that move at speeds less than 3 mph or involve frequent short stops that do not exceed durations of 30 minutes. (i.e., litter cleanup, pothole patching)

Continuous – Mobile Operations that move continuously at all times at speeds of 3 mph or greater without any stops. (i.e., pavement striping, herbicide spraying, street sweeping)

TEMPORARY TRAFFIC CONTROL ZONE

A temporary traffic control zone is an area of a highway where the normal roadway conditions are changed because of the presence of a work zone. The work zone may include signs, channelizing devices, work vehicles, pedestrian workers, equipment and materials. It extends from the first warning sign, truck mounted changeable message sign or high intensity rotating, flashing, oscillating or strobe light on a vehicle to the "End Road Work" sign, last temporary traffic control device or the last work vehicle encountered by a motorist passing through the zone.

COMPONENTS

Advance Warning Area -

The advance warning area is the section of roadway where motorists are informed about a forthcoming work zone. The advance warning area of a stationary work zone usually includes a series of advance warning signs.

During mobile operations, the advance warning area may consist of a vehicle supplemented with a high intensity rotating, flashing, oscillating or strobe light, a truck mounted changeable message sign and/or a flat sheet advance warning sign.

Transition Area -

The transition area is the section of roadway where motorists are redirected out of their normal travel path. The transition area of a stationary work zone usually includes a merging taper, a shifting taper or a one-lane two-way traffic taper.

During mobile operations, advance warning regarding the presence of a mobile work area is provided to motorists through the operation of amber or yellow colored high intensity rotating or strobe type flashing auxiliary warning light devices, truck mounted advance warning arrow panels, truck mounted changeable message signs or flat sheet advance warning signs. However, the motorist shall maintain responsibility to determine when to alter or redirect their travel path during mobile operations.

Activity Area -

The activity area is the section of roadway where the work activity takes place. This area consists of the work area, the travel way for traffic and the buffer space.

The work area is the portion of the roadway closed to motorists and reserved for workers, equipment and material. This area is typically delineated and separated from the travel way by a series of traffic control devices or longitudinal barriers.

The travel way is the portion of the roadway which motorists are routed onto for passage through the activity area.

The buffer space is a longitudinal area between the downstream end of the transition area and the work area that may provide some recovery space for an errant vehicle. The buffer space shall remain absent of personnel, tools, equipment, materials, work vehicles, etc. The presence of personnel, tools, equipment, materials, work vehicles, etc., within the limits of the buffer space is PROHIBITED.

Termination Area -

The termination area is the section of roadway where the motorists are returned to the normal travel path. The termination area extends from the downstream end of the activity area to the last traffic control device or "End Road Work" sign or last work vehicle encountered by a motorist.

TAPERS

Tapers may be used in transition and termination areas. The length of a taper may require field adjustments due to field conditions such as hills, curves, intersecting roads, etc. A taper within a transition area provides notice to motorists the subsequent area is closed to travel and redirects the motorists onto a different travel path. A taper within a termination area provides notice to motorists the area closed to travel has ended and may provide guidance to motorists to return to the original travel path. A taper placed on a shoulder area provides notice to motorists that the subsequent shoulder area is closed and encroachment onto that portion of the shoulder is not allowed.

Tapers are developed through utilization of a series of traffic control devices. Taper lengths are determined by the legal posted regulatory speed limit of the roadway prior to beginning the work. See *Table 1, Formulas for Determining Taper Lengths*.

Table 1 Formulas for Determining Taper Lengths

Speed (S)	Taper Length (L) in Feet
40 mph or Less	$L = WS^2 / 60$
45 mph or more	$L = WS$

Where: L = taper length in feet
 W = width of offset in feet
 S = posted speed limit prior to work starting

There are various types of tapers which include merging tapers, shifting tapers, shoulder tapers, one-lane two-way traffic tapers and downstream tapers. For determination of taper lengths according to the type of taper, see *Table 2*.

A merging taper precedes the closure of a travel lane or travel path and requires motorists to merge into a common road space with motorists from an adjacent travel lane.

A shifting taper precedes a change in the roadway alignment and requires motorists to negotiate a lateral shift in their normal travel path.

A shoulder taper precedes a shoulder work area. A shoulder taper precedes a shoulder work area and provides notification to motorists that encroachment upon the subsequent shoulder area is not permitted.

A one-lane two-way traffic taper precedes a flagging operation that requires motorists from opposing directions on a two-lane two-way roadway to share a common travel lane as directed by the flagger(s).

A downstream taper follows the activity area to provide a visual cue to the motorist that access to their original travel path is available. Installation of a downstream taper is optional. See *Table 2, Taper Types and Taper Length Criteria*.

Table 2 Taper Types and Taper Length Criteria

Type of Taper	Taper Length
Merging Taper	at least 1 L
Shifting Taper	at least 0.5 L
Shoulder Taper	at least 0.33 L
One-Lane Two-Way Traffic Taper	50 feet minimum, 100 feet maximum
Downstream Taper	50 feet minimum, 100 feet maximum

Note: Use Table 1 to calculate L.

TRAFFIC CONTROL DEVICES

SIGNS

Temporary traffic control work zone signs include regulatory, warning and guide signs utilized to provide regulations, warnings and guidance information to road users impacted by the presence of a work zone within the highway rights-of-way. Henceforth, for general purposes when specific references are not required, all temporary traffic control work zone signs will be referred to as advance warning signs.

Mount the advance warning signs on either ground mounted u-channel or square steel tube posts, approved temporary sign supports or Type III barricades. **Do not mount advance warning signs on Type II barricades.** The mounting height of an advance warning sign, dependent upon the type of sign support the sign is attached to, is measured from the either the ground or the near edge of the adjacent travel lane or sidewalk when a sidewalk is present to the bottom edge of the sign. The mounting height of a sign attached to a ground mounted u-channel or square steel tube post is measured from the bottom edge of the sign to the grade elevation of the near edge of the adjacent travel lane or sidewalk when a sidewalk is present. The mounting height of a sign attached to an approved temporary sign support or Type III barricade is measured from the bottom edge of the sign to the ground or surface on which the sign support is located.

The mounting height of a primary regulatory or advance warning sign erected on a ground mounted u-channel or square steel tube post is 7 feet to 8 feet from the bottom edge of the sign to the grade elevation of the near edge of the adjacent travel lane or sidewalk when a sidewalk is present. The minimum mounting height of a secondary sign mounted on the same assembly is 6 feet from the bottom edge of the secondary sign to the grade elevation of the near edge of the adjacent travel lane or sidewalk when a sidewalk is present unless otherwise specified.

The minimum mounting height for guide signs, including detour sign assemblies with multiple sign panels, erected on ground mounted u-channel or square steel tube posts should be no less than 5 feet from the grade elevation of the near edge of the adjacent travel lane to the bottom of the route sign or the detour sign panel (M4-9) unless otherwise directed by the Department.

On primary and secondary routes, the minimum mounting height of advance warning signs erected on portable sign supports is 1 foot from the bottom edge of the sign to the ground. **However, during flagging operations, the minimum mounting height of advance warning signs erected on portable sign supports is 5 feet from the bottom edge of the sign to the ground.**

On interstate routes, the minimum mounting height of advance warning signs mounted on portable sign supports is 5 feet from the bottom edge of the sign to the ground or surface on which the sign support is located.

In accordance with the requirements of the MUTCD, the minimum mounting height of a temporary "Exit" sign (E5-1) (M1025-00) located within a temporary gore area during a lane closure on a multilane roadway is 7 feet from the bottom edge of the sign to the pavement surface.

On multilane primary routes, avoid placement of signs mounted on portable sign supports within paved median areas utilized for two-way left turns unless otherwise directed by the Engineer.

When mounting signs on multiple ground mounted sign supports, ensure that each post is of the same type. Combining and installing both ground mounted u-channel and square steel tube posts within the same sign assembly is prohibited.

When mounting signs on ground mounted u-channel or square steel tube posts, utilize either a sign support / ground support post combination with an approved breakaway assembly or a single direct driven post for each individual sign support of a sign assembly installation. Do not combine a sign support / ground support post combination and a direct driven post on the same sign assembly installation that contains two or more sign supports. Regarding sign support / ground support post combination installations, ensure that post lengths, stub heights and breakaway assemblies comply with the manufacturer's requirements and specifications. Use approved breakaway assemblies found on the *Approved Products List For Traffic Control Devices in Work Zones*.

Fabricate advance warning signs mounted on portable sign supports or Type III barricades from an approved roll-up retroreflective fabric material or an approved rigid aluminum laminate composite substrate.

Advance warning signs fabricated with 0.080 inch or 0.100 inch thick aluminum sign blanks are PROHIBITED for use with portable sign supports or Type III barricades. Refer to the *Approved Products List For Traffic Control Devices in Work Zones* for approved roll-up retroreflective fabric sign materials and approved rigid aluminum laminate composite sign substrates.

Fabricate rigid advance warning signs mounted on ground mounted u-channel or square steel tube posts from an approved sign substrate material constructed of aluminum or an approved aluminum laminate composite material. Use aluminum sign blanks that meet SCDOT specifications or sign blanks fabricated from approved aluminum laminate composite materials included on the *Approved Products List For Traffic Control Devices in Work Zones*.

Reflectorize orange advance warning signs and any orange areas of a multi-colored advance warning sign with fluorescent orange colored microprismatic retroreflective sheeting. Reflectorize white advance warning signs and any white areas of multi-colored advance warning signs with a white colored microprismatic retroreflective sheeting.

When advance warning signs mounted on portable sign supports are not in use, remove and relocate the portable sign supports to a location beyond 15 feet from the near edge line of a primary or secondary travel lane and beyond 30 feet from the near edge line of an interstate travel lane. On primary and secondary routes, when the 15 foot clear zone distance or rights-of-way is unavailable, store the portable sign supports at the greatest possible distance from the near edge of the adjacent travel lane. **Do not simply redirect a sign when not in use.** Ensure that all portable sign supports lie flat with the legs in a retracted position when not in use.

When advance warning signs mounted on ground mounted u-channel or square steel tube posts are not in use, cover the signs in their entirety with an opaque material or remove them from the work area when not in use. Cover the signs in their entirety to prevent any visualization of any portion of the sign by the motorist. Use weather resistant materials to cover signs to prevent any exposure of a covered sign due to adverse weather conditions or long periods.

When covering signs with opaque materials, do not attach a covering material to the face of the sign with tape or a similar product or any method that may leave a residue on the retroreflective sheeting. The residue from tape or similar products, as well as many methods utilized to remove such residue, will damage the retroreflectivity of the sign and render the sign ineffective, especially during the hours of darkness.

Install the advance warning signs at spacing intervals based on the posted regulatory speed limit of the roadway prior to beginning any work. When a work zone traffic control plan or a typical work zone traffic control standard drawing for maintenance operations is not available to indicate the spacing intervals for a typical 3 advance warning sign array installation, see *Table 3, Advance Warning Sign Placement Intervals for a Typical 3 Advance Warning Sign Array*.

Table 3 Advance Warning Sign Placement Intervals for a Typical 3 Advance Warning Sign Array

URBAN / RURAL (LOW SPEED) 35 MPH or LESS	200 / 200 / 200 Feet
URBAN / RURAL (INTERMEDIATE SPEED) 40 - 50 MPH	350 / 350 / 350 Feet
RURAL (HIGH SPEED) 55 MPH or GREATER	500 / 500 / 500 Feet
INTERSTATE	1000 / 1500 / 2600 Feet

CHANNELIZING DEVICES

Channelizing devices provide warning to motorists of potential hazards in work zones. These devices channelize vehicular and pedestrian traffic away from potential hazards. Also, these devices provide guidance to motorists by delineating the travel path intended for use by motorists. Typical channelizing devices utilized by SCDOT include 28" or 36" standard traffic cones, 42" oversized traffic cones, portable plastic drums and barricades. **The following paragraphs provide descriptions of these traffic control devices and how these devices may be used. Specific applications of these devices will be determined by the typical traffic control setup and any specific requirements of the maintenance activity.**

Standard Traffic Cones -

The 28" or 36" standard traffic cones may be utilized to delineate travel lanes and to channelize traffic through the tangent section or activity area of lane closures, during daytime shoulder closures and to mark specific hazards. When utilized in lane closures, replace the 28" or 36" standard traffic cones with 42" oversized cones or portable plastic drums when a daytime operation extends into the nighttime hours. Use reflectorized 28" or 36" standard traffic cones during the hours of darkness during emergencies ONLY. Non-reflectorized 28" or 36" standard traffic cones are PROHIBITED for emergency use during nighttime hours.

Standard traffic cones utilized during daytime lane closures on interstate roadways shall have a minimum height of 36 inches.

Maintain 28" or 36" standard traffic cones in good condition. Replace and do not use 28" or 36" standard traffic cones that have completed their functional service life.

42" Oversized Traffic Cones -

The 42" oversized traffic cones may be utilized to delineate and channelize traffic through the tangent section or activity area of lane closures and to mark specific hazards. Also, the 42" oversized traffic cones may be utilized during flagging operations on two-lane two-way roadways. Reflectorize the 42" oversized traffic cones with Type III flexible microprismatic retroreflective sheeting unless otherwise directed by the department. Use 42" oversized traffic cones in place of 28" or 36" standard traffic cones in lane closures during the hours of darkness.

The 42" oversized traffic cones are permitted for use during flagging operations on two-lane two-way roadways, lane closures on multilane roadways, daytime shoulder closures and to mark specific hazards ONLY. The 42" oversized traffic cones are unacceptable for delineation of a pavement edge; portable plastic drums are required for delineation of a pavement edge.

Maintain 42" oversized traffic cones in good condition. Replace and do not use 42" oversized traffic cones that have completed their functional service life.

Portable Plastic Drums -

Portable plastic drums may be utilized to delineate travel lanes, channelize traffic through the tangent section or activity area of a lane closure, delineate shoulder closures, delineate the pavement edge of a roadway and delineate excavations and structures. Reflectorize portable plastic drums with Type III flexible microprismatic retroreflective sheeting unless otherwise directed by the department. Portable plastic drums are the preferred traffic control device for channelization and delineation of a travel way during the hours of darkness.

Maintain portable plastic drums in good condition. Replace and do not use portable plastic drums that have completed their functional service life.

Barricades -

Type II barricades may be utilized to develop taper sections and channelize traffic into lane closures, delineate travel lanes and delineate excavations and structures.

Although included in this section regarding channelizing devices, Type III barricades are used to close a roadway to traffic and to prevent traffic from entering a work area rather than channelizing traffic around or away from a potential hazard. However, in some installation scenarios the alternating diagonal orange and white stripes do indicate a possible direction of travel or lack thereof.

Reflectorize all barricades with Type III high intensity or Type IX or XI Microprismatic retroreflective sheeting unless otherwise directed by the department.

Type II barricades shall have alternating diagonal orange and white stripes sloping downward at a 45 degree angle in the direction traffic is to pass.

Type III barricades shall have alternating diagonal orange and white stripes sloping downward at a 45 degree angle. At locations where the barricades extend entirely across a roadway, the stripes should slope downward in the direction toward which motorists must turn or pass. At locations where both right and left turns are provided, the stripes should slope downward in both directions from the center of the barricade or from the center of the assembly of barricades to the outside edges. At locations where the roadway is closed to traffic and no turns are available, the stripes should slope downward toward the center of the barricade or the center of the assembly of barricades.

Type III barricades may be supplemented with advance warning signs. Only advance warning signs fabricated from either an approved roll-up retroreflective fabric material or an approved rigid aluminum laminate composite substrate may be mounted on or attached to a Type III barricade. Do not attach a sign fabricated from any other type of sign substrate to a Type III barricade. Refer to the *Approved Products List For Traffic Control Devices in Work Zones* for approved roll-up retroreflective fabric sign materials and approved rigid aluminum laminate composite sign substrates.

Maintain barricades in good condition. Replace and do not use barricades that have completed their functional service life.

Installations of the traffic control channelizing devices illustrated on the drawings are for normal conditions. Adjustments may be required due to horizontal and/or vertical alignments or other sight distance restrictions.

Maximize the effective and positive impact of a traffic control channelizing device by installing the device in a location and in an application suitable to the device. Always consider roadway type, roadway classification, light conditions (day vs. night), traffic speeds, traffic volumes, potential sight distance restrictions, etc., when determining which traffic control channelizing device is best suited for a traffic control setup. Unless otherwise directed by a work zone traffic control plan or a typical work zone traffic control standard drawing for maintenance operations, utilize the specified traffic control channelizing devices within lane closures and shoulder closures as directed. See *Table 4, Traffic Control Channelizing Device Applications*.

Table 4 Traffic Control Channelizing Device Applications

LANE CLOSURE				SHOULDER CLOSURE			
PRIMARY & SECONDARY		INTERSTATE		PRIMARY & SECONDARY		INTERSTATE	
DAY	NIGHT	DAY	NIGHT	DAY	NIGHT	DAY	NIGHT
28" Cones	-----	-----	-----	28" Cones	-----	-----	-----
36" Cones	-----	36" Cones	-----	36" Cones	-----	36" Cones	-----
42" Cones	42" Cones	42" Cones	42" Cones	42" Cones	-----	42" Cones	-----
Drums	Drums	Drums	Drums	Drums	Drums	Drums	Drums

WARNING LIGHTS

Supplemental Warning Lights for Traffic Control Devices -

Type A, Type B, Type C and Type D warning lights are yellow or amber, portable, lens directed and enclosed. Types A and B lights operate in a flashing mode and Types C and D lights operate in a steady burn mode.

All warning lights shall meet the requirements of the *MUTCD*. The weight of these lights shall not exceed 3.3 pounds in accordance with the requirements of *NCHRP Report 350* or the *AASHTO Manual for Assessing Safety Hardware (MASH)*.

Mount all warning lights on signs or channelizing devices in a manner that, if hit by an errant vehicle, the light will not be likely to penetrate the windshield of the errant vehicle.

The minimum mounting height of a warning light is 30 inches from the bottom of the lens of the light to the travel lane surface when placed in a roadway or to the grade elevation of the near edge of the adjacent travel lane when placed adjacent to a roadway.

When utilizing a warning light with a battery pack, ensure the battery pack is detachable and place the battery pack on the ground.

Use Types A, B, C and D warning lights as supplemental traffic control devices for signs and barricades.

Auxiliary Warning Lights for Vehicles and Equipment -

All vehicles and equipment that operate within or adjacent to a roadway within the highway right-of-way in an active continuous or intermittent mobile operation or a stationary work zone are required to be supplemented with auxiliary warning lights. Also, this requirement shall include vehicles that must operate within the roadway or on a roadway shoulder at reduced speeds. For further information regarding auxiliary warning light requirements, see the “SCDOT Warning Light Standardization” guide, latest edition.

All auxiliary warning lights supplementing vehicles and equipment within active work zones shall be yellow or amber in color.

All auxiliary warning lights shall be high intensity rotating, flashing, oscillating or strobe lights.

Mount all auxiliary warning lights on vehicles and equipment no less than 3 feet above the ground and in conspicuous locations to provide good visibility to approaching motorists.

Standard vehicle hazard warning lights are only permitted as a supplement to the auxiliary warning lights.

A “Directional Arrow” warning light device, Arrow Board Type D, is not considered an equal to an advance warning arrow panel and is **PROHIBITED** as a substitute for an advance warning arrow panel when an advance warning arrow panel is specified and required.

A “Directional Arrow” warning light device, Arrow Board Type D, should only be utilized as a supplement to SCDOT approved high intensity rotating, flashing, oscillating or strobe lights.

TRAILER MOUNTED TRAFFIC CONTROL DEVICES

Advance Warning Arrow Panels -

Use trailer mounted advance warning arrow panels to provide additional advance warning and directional information to assist motorists through a work zone. Make certain to provide these warning devices for advance directional information in lane closures. All trailer mounted advance warning arrow panels shall comply with department specifications.

All trailer mounted advance warning arrow panels shall be either a Type A, B or C. All advance warning arrow panels shall comply with the requirements for minimum size, legibility distance and minimum number of elements. See *Table 5, Advance Warning Arrow Panels (Trailer Mounted)*.

Table 5 Advance Warning Arrow Panels (Trailer Mounted)

Arrow Panel Type	Minimum Size	Minimum Legibility Distance	Minimum Number Of Elements
A	48" x 24"	½ Mile	12
B	60" x 30"	¾ Mile	13
C	96" x 48"	1 Mile	15

A trailer mounted advance warning arrow panel shall have a minimum mounting height of 7 feet from the bottom of the sign panel to the surface on which the unit is placed.

Trailer mounted advance warning arrow panels shall remain stationary when operating. Do not tow trailer mounted advance warning arrow panels while operating. Towing an operating trailer mounted advance warning arrow panel in place of utilizing a truck mounted advance warning arrow panel when a truck mounted device is required is PROHIBITED. Do not place, attach or mount a trailer mounted advance warning arrow panel on or to the bed, body, etc. of a truck to act as a truck mounted device.

The trailer mounted advance warning arrow panel is a supplemental traffic control device. Use of a trailer mounted arrow panel as a singular entity is PROHIBITED.

Do not use a trailer mounted advance warning arrow panel operating in a Flashing Arrow Mode or a Sequential Chevron Mode as a part of a flagging operation to direct vehicles into lanes used by opposing traffic.

Use the Flashing Arrow Modes, the Sequential Chevron Modes or the Caution Mode. Do not display Sequential Stem Arrow Modes due to staged and slow development of the intended message by these message modes.

The Caution Mode requires a pattern of 4 lamps with 1 lamp in each corner flashing simultaneously (referred to as the "4 Corners" pattern). Ensure the "4 Corners" pattern does not indicate direction or resemble any other mode. Do not use trailer mounted advance warning arrow panels incapable of producing the "4 Corners" pattern. Do not display a "bar," "alternating diamond(s)," or any other symbol other than the required "4 Corners" pattern during the Caution Mode.

Utilize the Caution Mode to alert motorists they are approaching an area impacted by work activities. Utilize the Caution Mode at locations and during operations that do not mandate relocation of traffic to an adjacent travel lane.

Changeable Message Signs -

Use trailer mounted changeable message signs to provide additional advance warning and directional information to assist motorists through a work zone. Consider utilizing these warning devices for advance information to assist motorists on high volume high speed roadways or on any job site that advance information may be beneficial to motorists. All trailer mounted changeable message signs shall comply with department specifications.

The trailer mounted changeable message sign shall have a minimum mounting height of 7 feet from the bottom of the sign panel to the surface on which the unit is placed when raised into its operating position.

Trailer mounted changeable message signs shall remain stationary when operating. Do not tow trailer mounted changeable message signs while operating. Towing an operating trailer mounted changeable message sign in place of utilizing a truck mounted changeable message sign when a truck mounted device is required is PROHIBITED. Do not place, attach or mount a trailer mounted changeable message sign on or to the bed, body, etc. of a truck to act as a truck mounted device.

When a trailer mounted changeable message sign is non-operational for more than 72 hours, remove the sign from the roadway.

Use pre-programmed messages in accordance with the typical standard drawings in this manual when the trailer mounted changeable message signs are used as part of the traffic control setup for lane closures. Display only those messages pertinent to the traffic control situation and traffic conditions. Do not use messages on a changeable message sign that duplicate the legends on the advance warning signs.

On primary and secondary routes, place the trailer mounted changeable message sign on the shoulder of the roadway not less than 6 feet from the edge of the sign to the near edge of the adjacent travel lane when space is available. When the 6 foot space or right-of-way is unavailable, place the trailer mounted changeable message sign at the greatest possible distance up to 6 feet from the near edge of the adjacent travel lane.

On primary and secondary routes, when a trailer mounted changeable message sign is placed within the limits of a paved shoulder or remains in place adjacent to a travel lane when inoperative, regardless of the shoulder type, supplement the trailer mounted changeable message sign location with not less than 5 portable plastic drums placed between the sign and the adjacent travel lane for delineation of the sign location. Space these portable plastic drums at 3 to 5 foot intervals; see Drawing No. 505-03-A for the proper arrangement of these drums. This requirement for delineation of the sign location applies at all times under the aforementioned conditions during which the sign is within 15 feet of the near edge of a travel lane open to traffic. Use of 28" or 36" standard traffic cones or 42" oversized traffic cones as substitutes for the portable plastic drums in this application is unacceptable. Delineation of the sign location may be omitted when the trailer mounted changeable sign is located behind guardrail or temporary concrete barrier wall.

On interstate routes, place the trailer mounted changeable message sign on the shoulder of the roadway not less than 6 feet from the edge of the sign to the near edge of the adjacent travel lane. Supplement the sign location with no less than 5 portable plastic drums placed between the sign and the adjacent travel lane for delineation of the sign location. Install and maintain the drums not closer than 3 feet from the near edge of the adjacent travel lane. Space these portable plastic drums at 3 to 5 foot intervals; see Drawing No. 510-01-A for the proper arrangement of these drums. The requirement for delineation of the sign location applies at all times during which the sign is within 30 feet of the near edge of a travel lane open to traffic. Use of 28" or 36" standard traffic cones or 42" oversized traffic cones as substitutes for the portable plastic drums in this application is unacceptable. Delineation of the sign location may be omitted when the trailer mounted changeable sign is located behind guardrail or temporary concrete barrier wall.

TRUCK MOUNTED TRAFFIC CONTROL DEVICES

Advance Warning Arrow Panels -

Use truck mounted advance warning arrow panels to provide additional advance warning and directional information to assist motorists through a work zone during but not limited to lane closures, shoulder closures and mobile operations. All truck mounted advance warning arrow panels shall comply with department specifications.

All truck mounted advance warning arrow panels shall be either a Type A, B or C. All advance warning arrow panels shall comply with the requirements for minimum size, legibility distance and minimum number of elements. See *Table 6, Advance Warning Arrow Panels (Truck Mounted)*.

Table 6 Advance Warning Arrow Panels (Truck Mounted)

Arrow Panel Type	Minimum Size	Minimum Legibility Distance	Minimum Number Of Elements
A	48" x 24"	½ Mile	12
B	60" x 30"	¾ Mile	13
C	96" x 48"	1 Mile	15

A truck mounted advance warning arrow panel shall have a minimum mounting height of 7 feet from the bottom of the sign panel to the surface on which the truck is operating when the arrow panel is in its operating position.

Only advance warning arrow panels designed and manufactured specifically for attachment to vehicles are approved as truck mounted advance warning arrow panels when a truck mounted device is required. Towing an operating trailer mounted advance warning arrow panel in place of utilizing a truck mounted advance warning arrow panel is PROHIBITED. Do not place, attach or mount a trailer mounted advance warning arrow panel on or to the bed, body, etc. of a truck to act as a truck mounted device.

Do not use a truck mounted advance warning arrow panel operating in a Flashing Arrow Mode or a Sequential Chevron Mode as a part of a flagging operation to direct vehicles into lanes used by opposing traffic. A truck mounted advance warning arrow panel shall operate in the "4 Corners" caution mode ONLY when utilized in conjunction with a flagging operation.

Use the Flashing Arrow Modes, the Sequential Chevron Modes or the Caution Mode. Do not display Sequential Stem Arrow Modes due to staged and slow development of the intended message by these message modes.

The Caution Mode requires a pattern of 4 lamps with 1 lamp in each corner flashing simultaneously (referred to as the "4 Corners" pattern). Ensure the "4 Corners" pattern does not indicate direction or resemble any other mode. Do not use truck mounted advance warning arrow panels incapable of producing the "4 Corners" pattern. Do not display a "bar," an "alternating diamond(s)" or any other symbol other than the required "4 Corners" pattern during the Caution Mode.

Utilize the Caution Mode to alert motorists they are approaching an area impacted by work activities. Utilize the Caution Mode at locations and during operations that do not mandate relocation of traffic to an adjacent travel lane.

Changeable Message Signs -

Use truck mounted changeable message signs to provide additional advance warning and directional information to assist motorists through a work zone. Consider utilizing these warning devices for advance information to assist motorists on high volume high speed roadways or on any job site that advance information may be beneficial to motorists. All truck mounted changeable message signs shall comply with department specifications.

The truck mounted changeable message sign shall have a minimum mounting height of 7 feet from the bottom of the sign panel to the surface on which the truck is operating when the changeable message sign is in its operating position.

Only changeable message signs designed and manufactured specifically for attachment to vehicles are approved as truck mounted changeable message signs when a truck mounted device is required. Towing an operating trailer mounted changeable message sign in place of utilizing a truck mounted changeable message sign is PROHIBITED. Do not place, attach or mount a trailer mounted changeable message sign on or to the bed, body, etc. of a truck to act as a truck mounted device.

The display panel shall have full matrix capability and provide two message lines with the capability to display 7 characters per line with a character height of 18 inches. **Display all messages with a minimum character height of 18 inches.**

When traffic queues develop during lane closures on multilane roadways, a truck mounted changeable message sign may be utilized to provide advance notice to motorists that the motorists are approaching a traffic queue and should be prepared to stop. When used in association with a traffic queue, place the truck mounted changeable message sign on the shoulder of the roadway. On high speed roadways, maintain the truck mounted changeable message sign no less than 2000 feet in advance of the traffic queue at all times. Do not place a truck mounted changeable message sign on the shoulder of a roadway without an operator. The truck mounted changeable message sign shall have the capability to display the message, "PREPARE TO STOP", with a minimum character height of 18 inches.

During mobile operations on multilane roadways, a truck mounted changeable message sign may be used to provide advance notice to motorists that the motorists are approaching a work operation operating in the travel lane. When used in association with a mobile operation, the truck mounted changeable message sign should flash alternately to read "RIGHT LANE", "CLOSED AHEAD" during operations in the right travel lane or "LEFT LANE", "CLOSED AHEAD" during operations in the left travel lane. Place and operate the truck mounted changeable message sign on the roadway shoulder unless the shoulders are too narrow to accommodate vehicles, the shoulders are structurally inadequate or curb and gutter is present. When site conditions require the truck mounted changeable message sign to operate within the travel lane, the changeable message sign shall display a flashing arrow. The flashing arrow display on a truck mounted changeable message sign is permissible only when the changeable message sign must operate in a travel lane. Do not display the flashing arrow on a truck mounted changeable message sign when the changeable message sign operates on the shoulder.

Use pre-programmed messages in accordance with the typical standard drawings in this manual when the truck mounted changeable message signs are used as part of the traffic control setup. Display only those messages pertinent to the traffic control situation and traffic conditions. Do not use a message on a truck mounted changeable message sign that duplicates the legends on the advance warning signs.

Truck Mounted Attenuators -

Truck mounted attenuators approved for use by the SCDOT includes the conventional type truck mounted attenuators mounted directly to a truck and the trailer type truck mounted attenuators towed behind a truck.

Use truck mounted attenuators to provide separation between approaching vehicular traffic and a work zone. These devices are especially effective in areas where pedestrian workers are conducting work activities within the limits of a travel lane. Utilize these devices in lane closures, shoulder closures, mobile operations and similar scenarios. These devices may be mounted directly to a truck or on a trailer. All truck mounted attenuators shall comply with department specifications.

All approved truck mounted attenuators are classified as *NCHRP Report 350* Test Level 2 or Test Level 3. Determine if a Test Level 2 or Test Level 3 truck mounted attenuator is suitable to a specific roadway based upon the legal posted regulatory speed limit of the specified roadway prior to the presence of a work zone or a temporary speed limit within a work zone.

Test level 2 truck mounted attenuators are approved for roadways with legal posted regulatory speed limits of 45 mph or less. Do not utilize test level 2 truck mounted attenuators on Interstate highways or roadways with posted regulatory speed limits of 50 mph or greater.

Test level 3 truck mounted attenuators are approved for roadways with legal posted regulatory speed limits of 50 mph or greater. Test level 3 truck mounted attenuators are acceptable for use on all roadways.

Always provide a clear zone in front of a truck mounted attenuator for potential roll ahead during an impact from an errant vehicle. Always provide a clear zone of approximately 100 feet to the front of the vehicle unless otherwise prescribed by this manual. Also, do not position pedestrian workers or equipment in the immediate area in front of the vehicle due to the potential for the unit to roll forward during an impact. Do not place the truck mounted attenuator in advance of a stationary hazard such as a temporary concrete barrier wall that may restrict the roll ahead and impede the unit's capacity to function properly.

A direct truck mounted truck mounted attenuator is mounted and attached to brackets or similar devices connected to the frame of a truck. Attach each direct truck mounted truck mounted attenuator to the rear of a truck with a minimum gross vehicular weight (GVW) of 15,000 pounds (actual weight). If the addition of supplemental weight to the vehicle as ballast is necessary, contain the material within a structure constructed of steel. Construct this steel structure to have a minimum of four sides and a bottom to contain the ballast material in its entirety. A top is optional. Bolt this structure to the frame of the truck. Utilize a sufficient number of fasteners for attachment of the steel structure to the frame of the truck to ensure the structure will not part from the frame of the truck during an impact upon the attached truck mounted attenuator. Utilize either dry loose sand or steel reinforced concrete for ballast material within the steel structure to achieve the necessary weight. The ballast material shall remain contained within the confines of the steel structure and shall not protrude from the steel structure in any manner.

A trailer towed truck mounted attenuator is a trailer type attenuator towed from behind and attached to the frame of a truck via a standard pintle hook / hitch. Attach each trailer towed truck mounted attenuator to the rear of a truck with a minimum gross vehicular weight (GVW) of 10,000 pounds (actual weight). If the addition of supplemental weight to the vehicle as ballast is necessary, contain the material within a structure constructed of steel. Construct this steel structure to have a minimum of four sides and a bottom to contain the ballast material in its entirety. A top is optional. Bolt this structure to the frame of the truck. Utilize a sufficient number of fasteners for attachment of the steel structure to the frame of the truck to ensure the structure will not part from the frame of the truck during an impact upon the towed truck mounted attenuator. Utilize either dry loose sand or steel reinforced concrete for ballast material within the steel structure to achieve the necessary weight. The ballast material shall remain contained within the confines of the steel structure and shall not protrude from the steel structure in any manner.

WORK VEHICLES

When work vehicles operate within travel lanes open to traffic, the work vehicles shall travel in the same direction of roadway traffic.

When work vehicles operate within a closed travel lane or a closed shoulder area, they may travel in either direction as necessary. However, when operating within a closed travel lane or a closed shoulder area during the hours of darkness, the work vehicles should minimize travel in the opposite direction of roadway traffic due to visibility limitations of motorists due to darkness and the unpredictable reactions motorists may have from seeing opposing headlights in an area where opposing traffic is not anticipated by motorists.

On primary and secondary routes, when work vehicles are required to cross from one side of a roadway to the other side of the roadway, utilize flaggers to control the work vehicles entering or crossing the travel lanes of the roadway. Consider sight distance, vertical and horizontal curves of the roadway, prevailing speeds of traffic, frequency of the work vehicles entering or crossing the roadway and other site conditions that may impact the safety of the workers and motorists when determining the necessity of these flaggers. Ensure these flaggers do not stop traffic, cause traffic to change lanes or affect traffic in any manner. The work vehicles may not disrupt the normal flow of traffic or enter the travel lane of the roadway until a sufficient gap is present.

When working within the rights-of-way of controlled access roadways such as interstate highways, work vehicles should only change direction of travel at interchanges. These vehicles should not cross the roadway from the right side to the median or vice versa. Use a flagger to control the work vehicles when these vehicles attempt to enter the roadway from a closed lane or a closed shoulder. Ensure the flagger does not stop traffic, cause traffic to change lanes or affect traffic in any manner. The work vehicles may not disrupt the normal flow of traffic or enter the travel lane of the roadway until a sufficient gap is present.

DAYTIME AND NIGHTTIME WORK

The conditions of daytime and nighttime are defined in accordance with the level of natural light provided by the sun measured by a light meter. The terms "Daytime," "Hours of Daylight," or any similar term refers to a level of illumination greater than or equal to 54 Lx or 5 fc. The terms "Nighttime," "Hours of Darkness" or any similar term refers to a level of illumination less than 54 Lx or 5 fc.

In areas where work is being performed during the hours of darkness, furnish, place and maintain lighting facilities capable of providing light of sufficient intensity to facilitate visibility, safety within the work site and good workmanship. Arrange the lighting so that it does not produce glare or diminish the motorist's visibility; primarily those motorists driving in the direction opposing the direction the lighting is being targeted toward. Perform ride-through inspection when installing lighting facilities to evaluate the impacts to motorists' visibility.

Illuminate the work area by any combination of portable lights, standard electric lights, existing streetlights, etc., that provides the necessary illumination. See *Table 7, Work Area Illumination Requirements*.

Table 7 Work Area Illumination Requirements

Area of Illumination	Work Activity	Minimum Illumination Level Lx (fc)
General	Cleaning, Sweeping, Tacking, Painting, etc.	54 (5)
Tasks Around Equipment (50 foot Ahead / Behind)	Milling, Paving, Rolling, etc.	108 (10)

WORK ZONE TRAFFIC CONTROL PROCEDURES

WORK ZONE SETUP / REMOVAL

When installing a work zone, install the advance warning signs on all approaches prior to installing the traffic control devices. Perform removal of the traffic control devices and advance warning signs in the reverse sequence of installation. These methods will apply to all work zone traffic control procedures unless field conditions necessitate an alternate method. The following are typical installation scenarios.

Flagging Operations on Two-Lane Two-Way Roadways - Install the advance warning area (signs), the flagger station (flagger), the transition area (taper) and then the activity area (traffic control devices).

Lane Closures on Multilane Roadways - Install the advance warning area (signs), the transition area (taper) and then the activity area (traffic control devices).

Mobile Operations - When advance warning signs are used, install the advance warning signs prior to beginning the work.

FLAGGING OPERATIONS

A flagging operation is a stationary traffic control setup to temporarily control the flow of traffic when two opposing directions of traffic must share a common travel lane on a two-lane two-way roadway. A flagging operation may be necessary during a lane closure on a two-lane two-way roadway, an intermittent ramp closure or an intermittent encroachment of equipment onto a portion of the roadway. Conduct all flagging operations in accordance with this manual, the MUTCD and the SCDOT "Flagger's Handbook", latest edition.

Utilize flagging operations to direct traffic around work activities within a closed portion of the roadway and maintain a continuous traffic flow, therefore, stopped traffic shall not be required to stop for time durations greater than those listed below unless otherwise directed by the District Engineering Administrator. Begin measurement of the time interval immediately upon the moment the Flagger rotates the Stop/Slow paddle to display the "Stop" condition to the approaching motorists. See *Table 8, Traffic Stopped Time Durations for Flagging Operations*.

Table 8 **Traffic Stopped Time Durations for Flagging Operations**

LENGTH OF CLOSURE	MAXIMUM TIME DURATION FOR STOPPED TRAFFIC
1 MILE or LESS	5 Minutes
1 to 2 MILES	7 ½ Minutes

If the work activities require traffic to be stopped for periods greater than 5 to 7 ½ minutes as stated above, consider conducting work activities during times of lowest traffic volumes such as during the hours of darkness, alternate work methods or complete road closure with detour installation.

Several of the key features relevant to flagging operations that each person responsible for the installation, maintenance and operation of flagging operations must be aware of are defined below:

Single Flagger Flagging Operation - A flagging operation controlled by one flagger. A “Single Flagger Flagging Operation” is restricted to low volume low speed to intermediate speed roadways during daytime hours ONLY. The “Work Activity Area” is restricted to a maximum distance of 200 feet. Station the flagger at a location no further than 200 feet from the first traffic control device in the Approach Taper and no further than 200 feet from the last traffic control device in the Downstream Taper furthest away from the Work Activity Area.

Multiple Flaggers Flagging Operation - A flagging operation controlled by two or more flaggers. Station the flagger controlling traffic operating in the travel lane closed to traffic, the Closed Lane Flagger, adjacent to the first traffic control device in the Approach Taper. Station the flagger controlling traffic in the travel lane that remains open to two-way traffic, the Open Lane Flagger, 100 feet beyond the last traffic control device in the Downstream Taper furthest away from the Work Activity Area.

Approach Taper - This is a one-lane two-way taper placed in the travel lane where the work activity takes place. This taper precedes the Buffer Space and the Work Activity Area. The length of this taper may vary from 50 feet to 100 feet. Install and maintain no less than five (5) traffic control devices equally spaced at 10-foot to 25-foot intervals as necessary to correspond with the length of the taper.

Downstream Taper - This taper, placed in the travel lane where the work activity is to take place, follows the Work Activity Area and serves as the termination area for the closure of the travel lane. The length of this taper may vary from 50 feet to 100 feet. Install and maintain no less than five (5) traffic control devices equally spaced at 10-foot to 25-foot intervals as necessary to correspond with the length of the taper.

Flagger Station - This is the specific location of the flagger.

Closed Lane Flagger - This flagger is stationed adjacent to the first traffic control device in the Approach Taper who controls the traffic that requires relocation from the travel lane being closed to traffic.

Open Lane Flagger - This flagger is stationed 100 feet beyond the last traffic control device in the Downstream Taper furthest away from the Work Activity Area who controls the traffic operating in the travel lane remaining open to traffic.

Side Road Flagger - This flagger is stationed on an intersecting Side Road and controls the side road traffic entering into the roadway where the Work Activity Area is located.

Buffer Space - This area is located between the downstream end of the Approach Taper and the nearest limits of the Work Activity Area and may provide some recovery space for an errant vehicle. The presence of personnel, tools, materials, equipment, work vehicles, etc. within the limits of the Buffer Space is PROHIBITED.

Work Activity Area - Personnel, materials, equipment, work vehicles, etc. are present within this area to conduct the work.

Limits of the Work Activity Area - This is the boundary of the Work Activity Area first encountered, from either direction, by motorists passing by the Work Activity Area in the adjacent travel lane open to traffic and controlled by the flaggers.

Approach Lane - Traffic approaches an intersection or a specific location in this travel lane.

Departure Lane - Traffic departs from an intersection or a specific location in this travel lane.

Mainline Approach - This is an approach to the Work Activity Area on the roadway where the Work Activity Area is located.

Side Road(s) - A road that intersects the roadway on which the Work Activity Area is located.

Limits of the Intersection (Physical Area of an Intersection) - The limits of or physical area within an intersection is defined by the location of stop bars when present. When stop bars are absent, the limits of or physical area within an intersection is defined by the location points where the corner radii between adjacent roadway approaches tie to the edge of pavement or the edge of travel lane adjacent to the edge of pavement of each roadway approach.

Always ensure the Flagger Station provides sufficient stopping sight distance for approaching traffic. For the stopping sight distance as determined by the **posted regulatory speed limit** of the roadway, see *Table 11, Stopping Sight Distance*.

Lane closures for flagging operations are restricted to a maximum distance of 2 miles unless otherwise approved by the District Engineering Administrator. Minimize the distance of the lane closure to only the area(s) where the work activities are to take place. However, an increased distance in addition to the actual Work Activity Area, not to exceed the 2 mile maximum length, may be included in the lane closure to provide adequate stopping sight distance of the Flagger Station to approaching motorists.

Conduct the work in such a manner so as not to encroach onto the adjacent travel lane open to traffic. Install, maintain and adjust the traffic control devices as necessary to ensure proper delineation of the work area.

In the event work that requires flagging operations is being conducted at two different locations at the same time, separate the two locations by no less than 2 miles from the last traffic control device in the Downstream Taper of the first lane closure to the first traffic control device in the Approach Taper of the second lane closure encountered by a motorist.

Equip each flagger with a 24" x 24" Stop/Slow paddle with 8 inch high letters mounted on a rigid handle with a minimum length of 7 feet. Do not use flags except during emergency situations.

Maintain two-way radio communications between all flaggers.

Nighttime Flagging Operations

Each flagger shall wear safety apparel in compliance with the requirements of *ANSI / ISEA 107 Standard Performance for Class 3 Exposure*, latest revision, when conducting nighttime flagging operations.

Illuminate each Flagger Station with any combination of portable lights, standard electric lights, existing street lights, etc. that will provide a minimum illumination level of 108 lux or 10 foot candles when conducting nighttime flagging operations.

Supplement each array of advance warning signs on each Mainline Approach with a trailer mounted changeable message sign. These changeable message signs are not required on the Side Roads intersecting the roadway where the Work Activity Area is located. Also, these changeable message signs are not required during daytime flagging operations. Install the changeable message signs in advance of the "Road Work Ahead" sign (W20-1-48-A) on each Mainline Approach in accordance with the spacing intervals based on the posted regulatory speed limit of the roadway prior to beginning any work. See *Table 3, Advance Warning Sign Placement Intervals for Typical 3 Advance Warning Sign Array*. The messages should be "Prepare To Stop", "Flagger Ahead". **A truck mounted changeable message sign is not an acceptable alternative to a trailer mounted changeable message sign during nighttime flagging operations.**

Utilize portable plastic drums or 42" oversized traffic cones during nighttime flagging operations. In the event that portable plastic drums or 42" oversized traffic cones are not utilized in a daytime flagging operation and the flagging operation extends into the nighttime hours, replace all 28" or 36" standard traffic cones with either portable plastic drums or 42" oversized traffic cones.

Reflectorize all portable plastic drums and all traffic cones with Type III or greater flexible microprismatic retroreflective sheeting unless otherwise directed by the SCDOT.

Buffer Space

The minimum distance requirements for the Buffer Space are based upon the legal posted regulatory speed limit of the roadway prior to beginning the work. See *Table 9, Minimum Distance Requirements for a Buffer Space in a Flagging Operation*.

Table 9 Minimum Distance Requirements for a Buffer Space in a Flagging Operation

SPEED LIMIT	DISTANCES
LOW SPEED 35 MPH or LESS	200 Feet
INTERMEDIATE SPEED 40 - 50 MPH	300 Feet
HIGH SPEED 55 MPH	400 Feet

The lengths of a Buffer Space indicated in *Table 9* are for normal conditions. Adjustments to increase the length of a Buffer Space may be necessary due to vertical and horizontal curves that may obstruct sight distance, driveways, intersecting roadways, etc. when approved by the SCDOT.

When using a truck mounted attenuator (TMA), the length of the Buffer Space is measured from the downstream end of the Approach Taper to the back of the TMA. When not using a TMA, the length of the Buffer Space is measured from the downstream end of the Approach Taper to the beginning of the Work Activity Area.

The presence of personnel, tools, materials, equipment, work vehicles, etc. within the limits of the Buffer Space is PROHIBITED.

Signs and Traffic Control Devices

Install and maintain the proper array of advance warning signs for each Mainline Approach of a flagging operation prior to initiation of the operation and remove or cover all signs immediately upon termination of the operation.

Measure all advance warning sign locations for each Mainline Approach from the location of the adjacent Flagger Station.

Install the advance warning signs at spacing intervals based on the posted regulatory speed limit of the roadway prior to beginning any work. See *Table 3, Advance Warning Sign Placement Intervals for a Typical 3 Advance Warning Sign Array*. The advance warning sign placement intervals indicated in *Table 3*, are for normal conditions. Adjustments to these distance intervals may be necessary due to existing signs, driveways, intersecting roadways, horizontal and/or vertical roadway alignments or other sight distance restrictions.

Always maintain the Flagger Station within 500 feet of the "Flagger" (W20-7-48) symbol sign of the array of advance warning signs.

Install advance warning signs mounted on portable sign supports no less than 4 feet from the near edge of the sign to the near edge of an adjacent travel lane on roadways with grass shoulders and no less than 6 feet from the near edge of the sign to the near edge of an adjacent travel lane on roadways with paved shoulders. When curb & gutter is present, install the sign no less than 2 feet from the near edge of the sign to the face of the curb.

During flagging operations, the minimum mounting height of ALL signs mounted on portable sign supports is 5 feet from the bottom edge of the sign to the ground or surface on which the sign support is located.

When necessary to relocate the Flagger Station while actively maintaining the flagging operation, install an additional array of advance warning signs in advance of and relative to the location of the new Flagger Station immediately prior to relocating the flagger. Remove the array of advance warning signs in advance of the previous Flagger Station immediately upon completion of the relocation of the flagger to the new Flagger Station.

Utilize portable plastic drums or 42" oversized traffic cones during nighttime flagging operations. In the event that portable plastic drums or 42" oversized traffic cones are not utilized in a daytime flagging operation and the flagging operation extends into the nighttime hours, replace all 28" or 36" standard traffic cones with either portable plastic drums or 42" oversized traffic cones. Reflectorize all portable plastic drums and all traffic cones with Type III or greater flexible microprismatic retroreflective sheeting unless otherwise directed by the SCDOT.

Delineate the tangent area of the lane closure with the necessary traffic control devices to provide delineation of and to minimize encroachment by motorists into the closed travel lane. On roadways with posted regulatory speed limits of 35 MPH or less, install the traffic control devices at spacing intervals of 25 feet. On roadways with posted regulatory speed limits of 40 MPH or greater, install the traffic control devices at spacing intervals of 50 feet. These spacing intervals for the traffic control devices are based upon the posted regulatory speed limit of the roadway prior to beginning any work. See *Table 10, Traffic Control Device Spacing Intervals for Flagging Operations*.

Table 10 Traffic Control Device Spacing Intervals for Flagging Operations

SPEED LIMIT	SPACING INTERVALS
35 MPH or LESS	25 Feet
40 - 55 MPH	50 Feet

Advance Warning Arrow Panel

An advance warning arrow panel shall operate in the "Four Corners" caution mode when located within or between the limits of the advance warning sign arrays specific to a flagging operation. Operation of an advance warning arrow panel in an arrow, chevron or any other type of caution mode other than the "Four Corners" caution mode when located within or between the limits of the advance warning sign arrays as specified hereinbefore is PROHIBITED.

Truck Mounted Attenuator

A truck mounted attenuator is recommended but not required. However, when utilizing a truck mounted attenuator, locate the truck mounted attenuator approximately 100 feet in advance of the "Work Activity Area".

LANE CLOSURES

A typical lane closure is an installation of a specific array of traffic control devices to temporarily reduce the number of travel lanes on a multilane roadway through channelization and relocation of traffic from the closed travel lane into the remaining adjacent travel lane(s) open to traffic. The traffic control devices function to channelize the traffic and provide delineation of the separation of the travel lane(s) closed to traffic and the travel path open to traffic.

Traffic control setups differ for daytime and nighttime lane closures. Do not use daytime lane closure setups during the hours of darkness. Install nighttime lane closure setups when lane closures are required during the hours of darkness or required to remain in place during both daytime and the hours of darkness. Observe all time restrictions for lane closures as required by the Department.

The 28" or 36" standard traffic cones are acceptable traffic control devices for daytime lane closure setups and 42" oversized traffic cones or portable plastic drums are the required traffic control devices for nighttime lane closure setups. **Standard traffic cones utilized during daytime lane closures on interstate roadways shall have a minimum height of 36 inches.**

Convert a daytime lane closure setup to a nighttime lane closure setup whenever circumstances prohibit removal of a daytime lane closure before entering nighttime conditions. Replace the standard traffic cones with 42" oversized traffic cones or portable plastic drums.

On low speed roadways, install and operate a trailer mounted advance warning arrow panel within the taper of a single lane closure. Place the advance warning arrow panel on the roadway shoulder at the beginning of the taper. However, where the shoulders are narrow or site conditions restrict the use of the shoulder areas, place the advance warning arrow panel behind the channelizing devices of the taper as close as practical to the beginning of the taper. Placement of the advance warning arrow panel at the start of the taper is preferred.

On intermediate to high speed primary and secondary roadways, installation and operation of two trailer mounted advance warning arrow panels within the taper of a single lane closure is recommended for improved visibility by the motorists. However, no less than one advance warning arrow panel within the taper of a single lane closure is required. When operating a single advance warning arrow panel, place the arrow panel on the roadway shoulder at the beginning of the taper. On roadways where the shoulders may be narrow or site conditions restrict the use of the shoulder areas, place the advance warning arrow panel behind the channelizing devices of the taper as close as practical to the beginning of the taper. Placement of the advance warning arrow panel at the start of the taper is preferred. When utilizing two advance warning arrow panels within the taper of a single lane closure, place one arrow panel on the roadway shoulder at the beginning of the taper and a second arrow panel within the closure at the downstream end of the taper. However, where the shoulders are narrow or site conditions restrict the use of the shoulder areas, place the first advance warning arrow panel behind the channelizing devices of the taper as close as practical to the beginning of the taper. Placement of the first advance warning arrow panel at the start of the taper is preferred.

On interstate roadways, install and operate two trailer mounted advance warning arrow panels within the taper of a single lane closure. Place one advance warning arrow panel on the roadway shoulder at the beginning of the taper and a second within the closure at the downstream end of the taper.

Install and operate two trailer mounted advance warning arrow panels within each taper of a dual lane closure on low, intermediate and high speed primary and secondary roadways. Place one advance warning arrow panel at the beginning of each taper and a second advance warning arrow panel within the closure at the downstream end of each taper. However, where the shoulders are narrow or site conditions restrict the use of the shoulder areas adjacent to the beginning of the first taper of a dual lane closure, place the first advance warning arrow panel behind the channelizing devices of the first taper as close as practical to the beginning of the first taper. Placement of the first advance warning arrow panel at the start of the first taper of a dual lane closure is preferred.

Install and operate two trailer mounted advance warning arrow panels within each taper of a dual lane closure on interstate roadways. Place one advance warning arrow panel at the beginning of each taper and a second advance warning arrow panel within the closure at the downstream end of each taper.

Truck mounted advance warning arrow panels operating within the activity area of a lane closure shall operate in the Caution Mode anytime the truck is advanced beyond 250 feet (150 feet where indicated on Low Speed roadways) from the downstream end of the transition area (taper) of a lane closure.

On an interstate roadway, when a traffic queue develops, provide a truck with a truck mounted changeable message sign or a static sign to convey advance notice to motorists that the motorists are approaching a traffic queue and should be prepared to stop. Place this truck on the shoulder of the roadway and maintain the truck no less than 2000 feet in advance of the traffic queue at all times. Placement of this truck on the shoulder of the roadway without an operator is PROHIBITED. A truck mounted changeable message sign shall display the message, "PREPARE TO STOP", with a minimum character height of 18 inches and comply with all SCDOT specifications. If utilizing the static sign, the static sign shall be a 48-inch x 48-inch "Be Prepared To Stop" sign (W3-4-48) with a rigid sign substrate reflectorized with either Type VIII, Type IX or Type XI microprismatic fluorescent orange retroreflective sheeting with a sign legend composed of 8 inch black Series "C" letters. Supplement the static sign with two amber high intensity rotating, flashing, oscillating or strobe lights.

On low speed primary roadways, if work is being conducted at two different locations at the same time in the same travel lane, separate the two locations by not less than 1 mile from the end of the first lane closure to the beginning of the taper of the second lane closure. On all other roadways, if work is being conducted at two different locations at the same time in the same travel lane, separate the two locations by not less than 2 miles from the end of the first lane closure to the beginning of the taper of the second lane closure.

On low speed primary roadways, when work is being conducted at two different locations in different travel lanes at the same time, separate the two locations by not less than 2 miles from the end of the first lane closure to the beginning of the taper of the second lane closure. On all other roadways, when work is being conducted at two different locations in different travel lanes at the same time, separate the two locations by not less than 4 miles from the end of the first lane closure to the beginning of the taper of the second lane closure.

Determine if the required separation distance between lane closures is adequate by measuring from the end of the last traffic control device of the first closure that a motorist will encounter to the first traffic control device at the beginning of the taper of the second closure.

Restrict the length of a lane closure to a maximum distance of 2 miles unless otherwise directed by the District Engineering Administrator.

Do not install lane closures on high volume roadways with high volume commuter traffic during peak traffic periods unless otherwise directed by the District Engineering Administrator.

SHOULDER CLOSURES

A standard shoulder closure is an installation of a specific array of advance warning signs and traffic control devices to temporarily close the shoulder area of a roadway to vehicular and pedestrian traffic. When the work activity is conducted within 15 feet or less of the near edge of the adjacent travel lane, advance warning signs and traffic control devices are required for a standard shoulder closure. When the work activity is conducted beyond 15 feet from the near edge of the adjacent travel lane, only advance warning signs are required for a standard shoulder closure.

On primary and secondary roadways, standard shoulder closures may be necessary for work zones that may require the presence of personnel, tools, equipment, materials, vehicles, etc., beyond one foot but within 30 feet of the near edge of an adjacent travel lane as prescribed by this manual.

On primary and secondary roadways, install standard shoulder closures as follows:

CASE I: Install advance warning signs and traffic control devices to provide a 250 foot taper in advance of the closed shoulder area and to delineate the closed shoulder area when the shoulder area within 15 feet but not closer than 1 foot from the near edge of the adjacent travel lane is occupied by a work zone. A truck mounted attenuator is optional.

CASE II: Only advance warning signs are required whenever the shoulder area beyond 15 feet but within 30 feet of the near edge of the adjacent travel lane is occupied by a work zone.

On interstate roadways, standard shoulder closures may be necessary for work zones that may require the presence of personnel, tools, equipment, materials, vehicles, etc., beyond 10 feet but within 30 feet of the near edge of an adjacent travel lane as prescribed by this manual. The presence of personnel, tools, equipment, materials, vehicles, etc. within 10 feet or less of the near edge of an adjacent travel lane of an interstate roadway require closure of the adjacent travel lane except during specified maintenance performance activities with specific work zone traffic control setups provided for and prescribed by this manual.

On interstate roadways, install standard shoulder closures as follows:

CASE I: Install advance warning signs and traffic control devices to provide a 300 foot taper in advance of the closed shoulder area and to delineate the closed shoulder area when the shoulder area within 15 feet but not closer than 10 feet from the near edge of the adjacent travel lane is occupied by a work zone. A truck mounted attenuator is optional.

CASE II: Only advance warning signs are required whenever the shoulder area beyond 15 feet but within 30 feet of the near edge of the adjacent travel lane is occupied by a work zone.

Advance warning arrow panels supplementing truck mounted attenuators when the truck mounted attenuators are utilized should function in the “4 Corners” Caution mode, however, when pedestrian workers are present within 15 feet of the near edge of the adjacent travel lane, operate the advance warning arrow panel in the appropriate Flashing Arrow mode.

When a grassed median area within 30 feet of a travel lane is occupied by a short term stationary or longer work zone, close the adjacent shoulder(s) according to the “CASE I” and “CASE II” requirements as directed above. If the median area work activities are within 30 feet of both adjacent travel lanes, close both shoulders as necessary.

On primary and secondary roadways, 28” or 36” standard traffic cones, 42” oversized cones, and portable plastic drums are acceptable traffic control devices for daytime shoulder closure setups. Portable plastic drums are the required traffic control devices for nighttime shoulder closures.

On interstate roadways, 36" standard traffic cones, 42" oversized cones, and portable plastic drums are acceptable traffic control devices for daytime shoulder closure setups. Portable plastic drums are the required traffic control devices for nighttime shoulder closures.

MOBILIZED SHOULDER OPERATIONS

Mobilized shoulder operations are roadway shoulder area work zones with no more than one (1) single equipment unit that progress along the roadway at a slow pace and may require the equipment to encroach upon a travel lane or a paved shoulder to various degrees. The single equipment unit must be accompanied by a shadow vehicle when the stopping sight distance interval between the single equipment unit and an approaching motorist is unavailable based upon the posted regulatory speed limit of the roadway.

Consider mobilized shoulder operations for work activities that progress at speeds less than 3 mph, do not comply with the requirements for intermittent mobile operations and do not fully warrant closure of the adjacent travel lane.

Work activities that require more than one (1) single equipment unit, not including a shadow vehicle when one is necessary, do NOT comply with the requirements for mobilized shoulder operations. Therefore, conduct work activities that require more than one (1) single equipment unit under lane closures.

On two-lane two-way roadways, mobilized shoulder operations are unacceptable when the work activities require more than one (1) single equipment unit, not including a shadow vehicle when one is necessary, to conduct the work activities. Conduct these work activities under flagging operations.

Due to the mobility of these operations, the traffic control requirements are usually limited to the installation of advance warning sign assemblies for each approach that may be impacted by the work activities. Relocate the advance warning sign assemblies as necessary as the work zone is advanced along the roadway.

Utilize advance warning signs relative to the type of work activity being conducted. The various types of advance warning sign assemblies that may be utilized shall include the "Mowing" sign (W21-9-48) supplemented with the supplemental sign "Next 3 Miles" (W7-3a-42) for grass mowing operations. When pedestrian workers are present, the "Worker" sign (W21-1-48) is required. The "Worker" sign (W21-1-48) may be installed in addition to those signs relative to work activities that may not require pedestrian workers. For example, the "Worker" sign (W21-1-48) may be installed in addition to the "Mowing" sign (W21-9-48) when appropriate.

PRIMARY AND SECONDARY ROADWAYS -

Pedestrian Workers –

Pedestrian workers should remain beyond 1 foot of the near edge of an adjacent travel lane. However, when encroachment to within 1 foot of the near edge of the adjacent travel lane or upon the adjacent travel lane up to but no more than 2 feet by a pedestrian worker is necessary to conduct the work activities, do so in strict accordance with the requirements specified by this manual and those drawings that specifically designate acceptable locations for pedestrian workers.

On low speed roadways, speeds of 35 mph or less, pedestrian workers may encroach from the shoulder area to within 1 foot of the near edge of the adjacent travel lane or onto the adjacent travel lane up to but no more than 2 feet when the work activity area is channelized with traffic control devices as specified by Drawing Nos. 515-01-C and 515-01-D for shoulder closures. A shadow vehicle is required. Consider utilizing a truck mounted attenuator on low speed roadways with intermediate to high traffic volumes.

On low speed roadways, speeds of 35 mph or less, when work activities require pedestrian workers to encroach upon the adjacent travel lane more than 2 feet, close the travel lane to traffic. When closure of the adjacent travel lane is necessary, utilize flagging operations on two-lane two-way roadways and standard lane closures on multilane roadways.

On intermediate to high speed two-lane two-way roadways, speeds of 40 mph to 55 mph, when pedestrian workers must encroach to within 1 foot of the near edge of the adjacent travel lane or upon the adjacent travel lane, close the travel lane to traffic. Utilize flagging operations for these lane closures.

On intermediate to high speed multilane roadways, speeds of 40 mph to 60 mph, when pedestrian workers must encroach upon the adjacent travel lane up to but no more than 2 feet, provide and operate a shadow vehicle supplemented with an advance warning arrow panel and a truck mounted attenuator in the adjacent travel lane to provide separation between the location of the pedestrian workers and approaching traffic. The advance warning arrow panel shall display a flashing arrow.

Equipment / Vehicles -

All travel lanes may remain open to traffic when work vehicles or equipment encroach upon an adjacent travel lane up to but not more than 2 feet.

Brief encroachments by a single equipment unit or a work vehicle into an adjacent travel more than 2 feet are acceptable when necessary to bypass an obstacle such as a sign or utility pole.

On two-lane two-way roadways, mobilized shoulder operations are unacceptable when the work activities require more than one (1) single equipment unit, not including a shadow vehicle when one is necessary, to conduct the work activities. Conduct these work activities under flagging operations.

On multilane roadways, mobilized shoulder operations are unacceptable when the work activities require more than one (1) single equipment unit, not including a shadow vehicle when one is necessary, to conduct the work activities. Conduct these work activities under lane closures.

INTERSTATE ROADWAYS -

Equipment and pedestrians are permitted to encroach onto a paved shoulder up to but not more than 2 feet under a traffic control setup for a mobilized shoulder operation. Brief periodic encroachments more than 2 feet by equipment are permissible when the equipment is bypassing structures such as guardrail locations or bridge structures.

A work vehicle shall accompany pedestrian workers when the pedestrian workers are within 30 feet or less of an adjacent travel lane. The accompanying work vehicle shall remain within 100 feet of the work location of the pedestrian workers at all times.

Pedestrian workers may encroach onto a paved shoulder up to 2 feet. A pedestrian worker is PROHIBITED from encroaching onto a paved shoulder more than 2 feet under a traffic control setup for a mobilized shoulder operation.

Standard shoulder closures are required when the work activities require equipment, personnel or vehicles to encroach onto a paved shoulder more than 2 feet to perform the work except during brief periodic encroachments necessary for equipment to bypass structures such as guardrail locations and bridge structures. Due to the mobility of these roadway shoulder area work zones and the brevity of the encroachments of more than 2 feet upon a paved shoulder, the requirements for lane closures when personnel, tools, equipment, materials, vehicles, etc., are present on a paved shoulder within 10 feet of the near edge of an adjacent travel lane are waived for work activities typically conducted under mobilized shoulder operations as prescribed by this manual.

MOBILE OPERATIONS

INTERMITTENT MOBILE OPERATIONS -

An intermittent mobile operation is a mobile operation that moves at speeds less than 3 mph or involves frequent short stops. The minimal traffic flow impacts generated by these operations involve brief traffic flow speed reductions and slight travel path diversions.

Intermittent mobile operations may be performed by a single work vehicle or a vehicle train. A single work vehicle may be a car or truck type vehicle or a single piece of equipment. A vehicle train operating under the requirements of an intermittent mobile operation typically includes no more than 2 (two) vehicles to include either 1 (one) work vehicle or 1 (one) piece of equipment and a shadow vehicle. However, additional shadow vehicles may be utilized when deemed necessary by the RME or the RME's designated representative.

Work activities that require intermittent mobile operations during the hours of darkness should be minimized and avoided when possible. However, in the case of an emergency when nighttime intermittent mobile operations are required and a lane closure is not feasible, a minimum work zone traffic control setup should include a shadow vehicle(s) supplemented with a truck mounted attenuator.

Consideration for utilizing a shadow vehicle is based upon the availability of adequate stopping sight distance. A shadow vehicle should accompany the work vehicle when the distance interval between the location point at which an approaching prudent driver is first able to recognize the presence of the work vehicle and the location of the work vehicle is less than the numerical figure indicated for the sufficient stopping sight distance. **When a shadow vehicle is utilized, position the shadow vehicle to maintain adequate stopping sight distance between the shadow vehicle and approaching motorists. Field adjustments to the location of the shadow vehicle may be necessary to ensure the shadow vehicle is not positioned in a location that may create a hazardous situation due to limited stopping sight distance in regard to a prudent driver being able to recognize the presence of the shadow vehicle.**

On low volume low speed roadways, a shadow vehicle may be optional provided the work vehicles and/or equipment is equipped with amber or yellow colored high intensity rotating, flashing, oscillating or strobe auxiliary warning lights.

On low volume intermediate to high speed roadways and all intermediate and high volume roadways, the necessity of a shadow vehicle is determined by the availability of the stopping sight distance. When adequate stopping sight distance is available, a shadow vehicle is not required.

A minimum number of two (2) persons in the work vehicle is recommended so that one person may act as spotter while the other person performs the work.

Roadway characteristics such as type, speed classification and volume classification shall determine the traffic control requirements for intermittent mobile operations. The following restrictions shall apply to all intermittent mobile operations.

Primary and Secondary Routes

- A. The work vehicle and shadow vehicle shall utilize the shoulder areas as much as practical when stopped.
- B. The maximum time duration of a stop is 15 minutes if the work vehicle and/or a shadow vehicle must encroach upon a travel lane more than 2 feet.
- C. The maximum time duration of a stop is 30 minutes if the work vehicle and/or a shadow vehicle remain in the shoulder area in their entirety or encroaches upon a travel lane no more than 2 feet.

Interstate Routes

- A. Encroachment upon a travel lane by the work vehicle and a shadow vehicle is only permitted in those areas with shoulder areas inadequate to accommodate vehicles in their entirety due to the presence of a concrete median barrier wall or a bridge parapet wall. **Any encroachment upon an interstate travel lane without a shadow vehicle is PROHIBITED.**
- B. The maximum time duration of a stop is 5 minutes, unless otherwise directed by this manual, if the work vehicle and/or a shadow vehicle must encroach upon an adjacent travel lane due to a shoulder area inadequate to accommodate a vehicle in its entirety due to the presence of a concrete median barrier wall or a bridge parapet wall.
- C. The maximum time duration of a stop is 30 minutes if the work vehicle and/or a shadow vehicle remain in the shoulder areas in their entirety with no encroachment upon an adjacent travel lane.

STOPPING SIGHT DISTANCE -

The stopping sight distance interval for any specific location is determined by the **posted regulatory speed limit** of the roadway. For the stopping sight distance as determined by the **posted regulatory speed limit** of the roadway, see *Table 11, Stopping Sight Distance*.

Stopping Sight Distance: **The length of roadway necessary for a typical vehicle to stop before reaching a stationary object in its path.**

Table 11 **Stopping Sight Distance**

STOPPING SIGHT DISTANCE		
POSTED REGULATORY SPEED LIMIT	DISTANCE PASSENGER CAR	DISTANCE TRUCK
35 mph or less	250 feet	350 feet
40 mph To 55 mph	500 feet	750 feet
60 mph To 70 mph	750 feet	1100 feet

Roadway characteristics shall determine the vehicle train requirements for an intermittent mobile operation. Evaluate the potential sight distance restrictions, such as vertical and horizontal curves, and the posted regulatory speed limits prior to deployment of a work detail to determine the minimum vehicle train requirements.

VEHICLE TRAIN REQUIREMENTS -

Single Work Vehicle: A single work vehicle is permitted in locations where the stopping sight distance interval between the work vehicle and an approaching motorist is available based upon the posted regulatory speed limit of the specific location.

When a sufficient stopping sight distance interval is not available, a shadow vehicle is required. See "Vehicle Train" below to determine the required distance intervals between the shadow vehicle and the work vehicle.

Shadow Vehicle: Low Volume / Low Speed Roadways -

Shadow vehicles may be **OPTIONAL** provided the work vehicle / equipment is equipped with **AMBER** or **YELLOW** colored high intensity rotating, flashing, oscillating or strobe auxiliary warning lights.

Low Volume / Intermediate to High Speed Roadways -
Intermediate Volume to High Volume / Low Speed to High Speed Roadways -

A vehicle train consisting of a work vehicle and a shadow vehicle is required in locations the stopping sight distance interval between the work vehicle and an approaching motorist is unavailable based upon the posted regulatory speed limit of the specific location.

Primary and Secondary Routes -

The distance interval from the shadow vehicle to the work vehicle may vary from a minimum 50 feet up to but not more than the stopping sight distance interval based upon the posted regulatory speed limit of the specific location.

Interstate Routes -

The distance interval from the shadow vehicle to the work vehicle may vary from 100 feet up to but not more than 750 feet based upon the posted regulatory speed limit of the specific location.

On low volume low speed roadways, intermittent mobile operations may be conducted with one person in the work vehicle. However, a minimum number of 2 persons in the work vehicle is recommended so that one person may act as a spotter while the other person performs the work. **Shadow vehicles are optional for these operations provided the work vehicles and/or equipment is equipped with AMBER or Yellow colored high intensity rotating, flashing, oscillating or strobe auxiliary warning lights.**

On low volume intermediate speed to high speed roadways, intermittent mobile operations may be conducted with one person in the work vehicle. However, a minimum number of 2 persons in the work vehicle is recommended so that one person may act as a spotter while the other person performs the work. **Evaluate the potential sight distance restrictions and posted regulatory speed limits of these roadways prior to deployment of the work detail to determine the minimum vehicle train requirements.**

On intermediate volume low speed to high speed roadways, intermittent mobile operations should be conducted with no less than 2 persons in the work vehicle. One person should act as a spotter while the other person performs the work. **Evaluate the potential sight distance restrictions and posted regulatory speed limits of these roadways prior to deployment of the work detail to determine the minimum vehicle train requirements.**

On high volume low speed to high speed roadways, intermittent mobile operations should be conducted with no less than 2 persons in the work vehicle. One person should act as a spotter while the other person performs the work. **Evaluate the potential sight distance restrictions and posted regulatory speed limits of these roadways prior to deployment of the work detail to determine the minimum vehicle train requirements.**

Maintain two-way radio communication between all vehicles when more than 1 vehicle is utilized.

Supplement the work vehicles and the shadow vehicles with amber colored auxiliary warning lights. The auxiliary warning lights shall be high intensity rotating, flashing, oscillating or strobe lights. Standard vehicle hazard warning lights are only permitted as a supplement to the auxiliary warning lights.

The vehicles may also be supplemented with truck mounted advance warning arrow panels and truck mounted attenuators as prescribed by this manual.

CONTINUOUS MOBILE OPERATIONS -

A continuous mobile operation moves continuously at all times at speeds of 3 mph or greater without any stops. The minimal traffic flow impacts generated by these operations involve brief traffic flow speed reductions and travel path diversions.

Roadway characteristics such as type, speed classification, and volume classification shall determine the traffic control requirements for continuous mobile operations.

The distance intervals between the vehicles as indicated in the illustrations provided in this manual may require adjustments to compensate for sight distance obstructions created by hills and curves and any other conditions that may obstruct the sight distance between the vehicles. However, adjustments to the distance intervals between the vehicles should be maintained within the range of variable distance intervals indicated on the illustrations.

Maintain two-way radio communication between all vehicles in the vehicle train operating in this continuously moving mobile operation.

Supplement the work vehicles and the shadow vehicles with amber colored flashing dome lights. The vehicles may also be supplemented with truck mounted advance warning arrow panels and truck mounted attenuators as prescribed by this manual.

DETOURS

Conduct and maintain roadway detours by relocating traffic onto alternate routes and returning the traffic to the route closed for the work beyond the closed portion of the roadway. All detour routes should be approved by the District Engineering Administrator.

Design and install all detour route signing in accordance with SCDOT requirements and the illustrations prescribed by this manual.

Select roads for a detour route that have a pavement structure, width and geometry to safely sustain the type and amount of detoured traffic. Ensure the detour route has adequate sight distances at intersections, no bridges with posted weight limitations, travel lanes with adequate lane widths to accommodate the detoured traffic, adequate pavement markings and a good pavement surface. Also, during the detour route selection process consider factors such as school locations, emergency services access, areas of reduced speed limits, intersection geometry and traffic control at intersections impacted by the detour.

Monitor the detour during the operation so that any deficiencies that may arise can be addressed and corrected.

PACING OPERATIONS

A pacing operation is a temporary control of the traffic flow through a defined area without creating a complete cessation of the traffic flow. Use a specified array of traffic control devices, law enforcement officers and law enforcement vehicles to conduct a pacing operation. Pacing operations are only permitted on access controlled roadways such as interstate routes.

Assistance from the South Carolina Highway Patrol is required when a pacing operation is implemented.

The Highway Patrol troopers will intercept traffic in advance of the project site at a distance sufficient to provide a work period of 20 minutes or less. Close all on-ramps within the affected area in advance of the project site until the queue of controlled traffic has passed. Station a uniformed law enforcement officer at the point of closure on each ramp. Uniformed law enforcement officers are the only acceptable individuals permitted to enforce these ramp and intersecting roadway closures.

Organize all personnel and equipment to conduct and complete the necessary work tasks prior to the arrival of the controlled traffic flow. Conduct the necessary work in a time period no longer than 20 minutes. Upon completion of the 20 minute time period, allow the controlled traffic flow to clear the work site after each event and resume normal traffic flow through the work site location prior to initiating a subsequent pacing operation. Make all reasonable efforts to expedite the work and minimize interference with traffic.

Utilize pacing operations at times of the lowest traffic volumes. The hourly restrictions for lane closures at the subject location also apply to pacing operations. Do not conduct pacing operations during holidays, holiday weekends or special events unless otherwise directed by the District Engineering Administrator.

In the event a traffic queue should develop when conducting pacing operations, provide a truck equipped with either a truck mounted changeable message sign or a static sign to convey advance notice to motorists they are approaching a traffic queue and should be prepared to stop. Place this truck on the shoulder of the roadway and maintain the truck no less than 2000 feet in advance of the traffic queue at all times. Placement of this truck on the shoulder of the roadway without an operator is PROHIBITED. A truck mounted changeable message sign shall display the message, "PREPARE TO STOP", with a minimum character height of 18 inches and comply with all SCDOT specifications. If utilizing the static sign, the static sign shall be a 48-inch x 48-inch "Be Prepared To Stop" sign (W3-4-48) with a rigid sign substrate reflectorized with either Type VIII, Type IX or Type XI microprismatic fluorescent orange retroreflective sheeting with a sign legend composed of 8 inch black Series "C" letters. Supplement the static sign with two amber high intensity rotating, flashing, oscillating or strobe lights.

**TYPICAL WORK ZONE TRAFFIC CONTROL
STANDARD DRAWINGS
FOR
MAINTENANCE ACTIVITIES**

This section provides typical work zone traffic control installation and application illustrations for South Carolina Department of Transportation maintenance operations.

The designs and applications of the typical work zone traffic control installations included in this manual are based upon the roadway characteristics and traffic conditions such as roadway types, speed classifications, traffic volume classifications and work durations. These typical work zone traffic control drawings illustrate typical work zone traffic control setups and applications. Adjustments may be necessary due to field conditions. Acquire the RME's approval for any adjustments prior to implementation.

WORK ZONE SIGNING

STANDARD DRAWING NO. 105-01

Through

STANDARD DRAWING NO. 105-60

**ADVANCE CONSTRUCTION SIGNS
PORTABLE SIGN SUPPORTS INSTALLATION**

1. Measure all advance warning sign locations from the limits of the work area.
2. Install advance warning signs mounted on portable sign supports no less 4 feet from the near edge of the sign to the near edge of an adjacent travel lane on roadways with grass shoulders and no less than 6 feet from the near edge of the sign to the near edge an adjacent travel lane on roadways with paved shoulders. When curb & gutter is present, install the sign no less than 2 feet from the near edge of the sign to the face of the curb.
3. The mounting height for signs mounted on portable sign supports is measured from the ground to the bottom of the sign. On primary and secondary routes, the minimum mounting height of signs mounted on portable sign supports is 1 foot unless otherwise directed. **On interstate routes, the minimum mounting height of signs mounted on portable sign supports is 5 feet.**
4. **During flagging operations, the minimum mounting height of signs mounted on portable sign supports is 5 feet from the bottom edge of the sign to the ground or surface on which the sign support is located.**
5. In accordance with the requirements of the MUTCD, mount temporary "Exit" signs (E5-1) (M-1025) located within a temporary gore area during lane closures on multilane roadways a minimum of 7' from the pavement surface to the bottom edge of the sign.

DRAWING 105-01
 ADVANCE CONSTRUCTION SIGNS
 PORTABLE SIGN SUPPORTS
 INSTALLATION

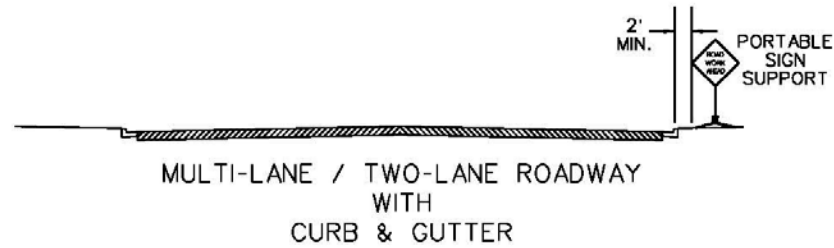
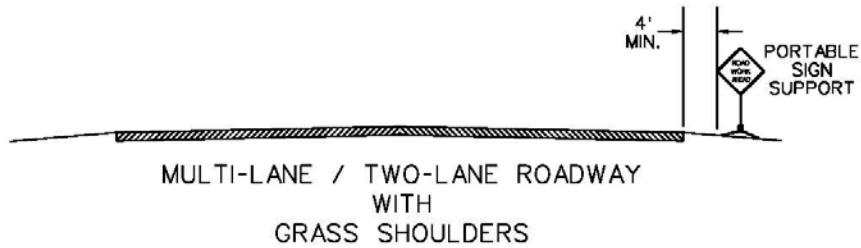
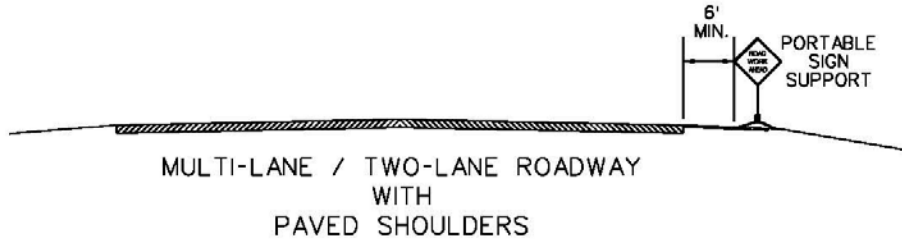
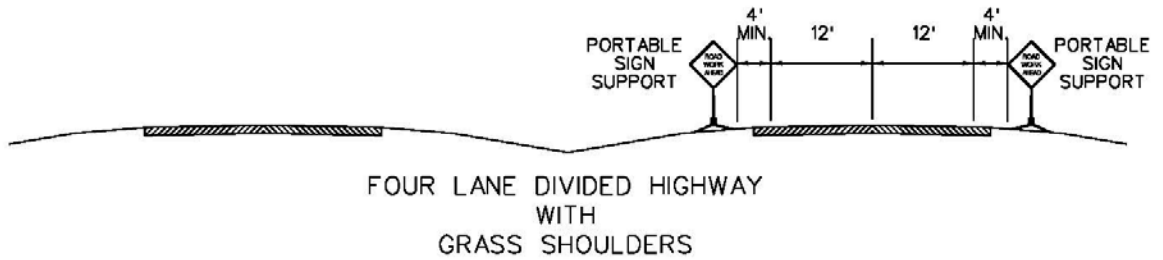
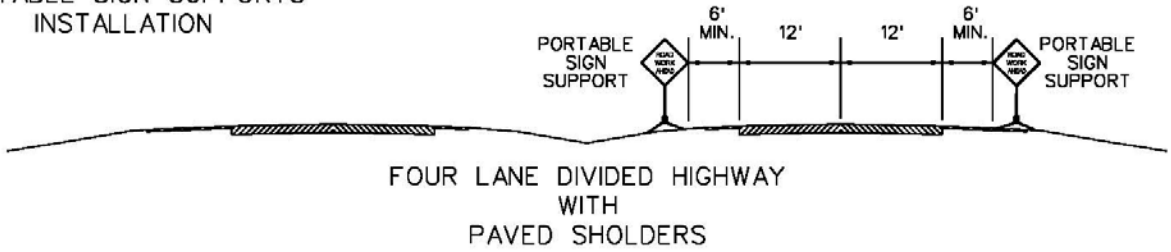

INTERSTATE
 ROUTES



PRIMARY & SECONDARY
 ROUTES

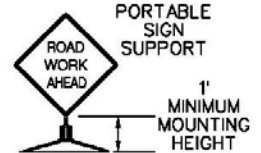

**WORK ZONE SIGNING
GROUND MOUNTED U-CHANNEL POSTS
BREAKAWAY SYSTEM INSTALLATION**

1. These requirements apply to work zone traffic control advance warning sign installations on u-channel posts.
2. These illustrations regarding breakaway system installations are intended for information ONLY. Similarity between the illustrations and any specific device or system is coincidental and is not intended as either a recommendation or an endorsement of a specific device or design.
3. All breakaway system hardware, including bolts, nuts, washers and spacers illustrated are typical and may vary in size, number, configuration and overall design in accordance with each specific manufacturer's design.
4. The ground support (stub) shall not exceed a height of 4 inches above the surface of the ground. The stub height may be less than 4 inches but never more than 4 inches.
5. Drive the ground support (stub) portion of the u-channel post into the ground to a depth of approximately 30 inches to 36 inches as specified by the manufacturer so that no more than 4 inches of the ground support (stub) extends above the surface of the ground. Remove enough soil from around the ground support (stub) to permit access to the holes for insertion and tightening of the lower bolt of the breakaway system. Replace the soil and tamp upon completion of the installation of the breakaway system.
6. The ground support (stub) is always between oncoming traffic and the sign support. Attach the sign support to the ground support (stub) on the side of the ground support (stub) opposite of oncoming traffic. Install the breakaway system to function in accordance with the direction of traffic in the adjacent travel lane.
7. The mounting height for regulatory and advance warning sign assemblies mounted on ground mounted u-channel posts is measured from the bottom edge of the primary sign to the grade elevation of the near edge of the adjacent travel lane. The mounting height of these signs should be 7 feet to 8 feet.
The minimum mounting height for a detour sign assembly with multiple sign panels mounted on a ground mounted u-channel post is no less than 5 feet from the grade elevation of the near edge of the adjacent travel lane to the bottom of the route sign or the detour sign panel (M4-9) unless otherwise directed by the Department.

DRAWING 105-10
 WORK ZONE SIGNING
 GROUND MOUNTED
 U-CHANNEL POSTS
 BREAKAWAY SYSTEM
 INSTALLATION

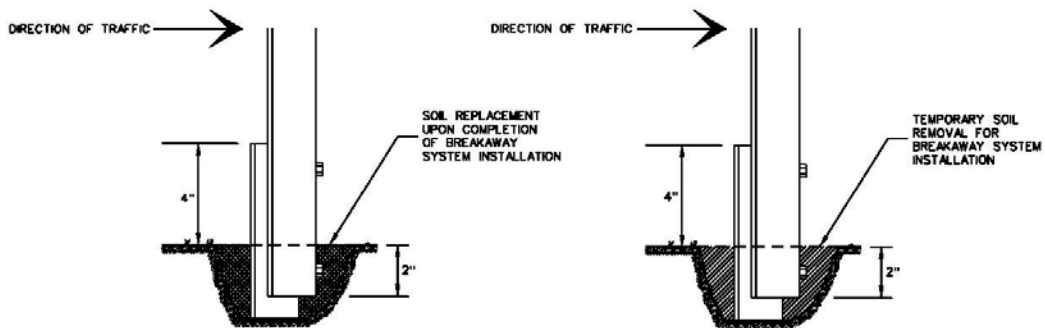
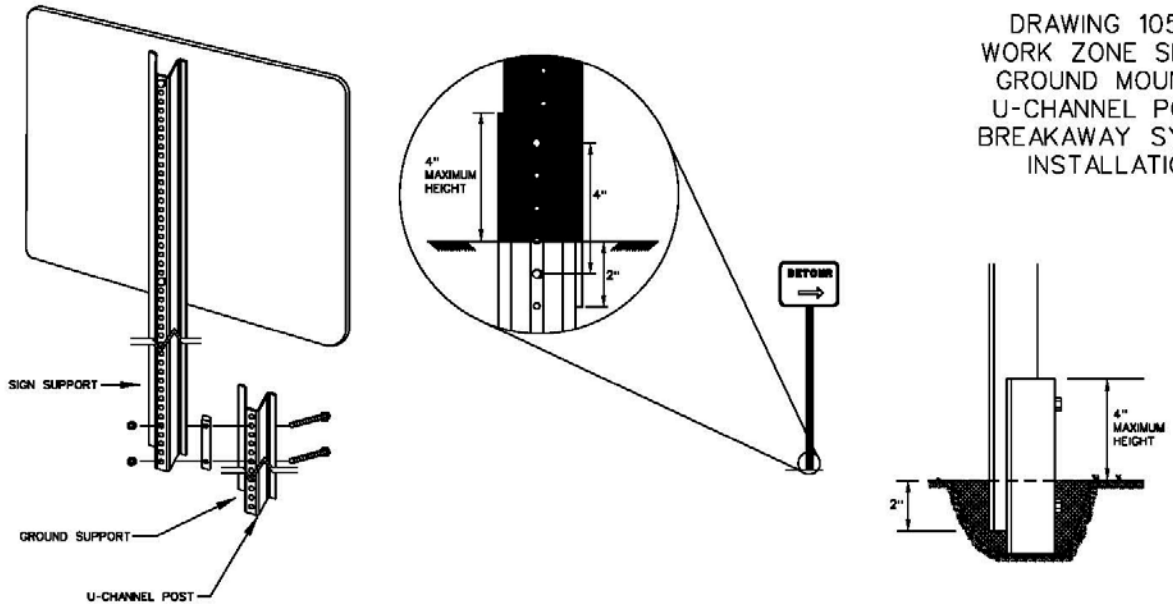

DRIVE THE GROUND SUPPORT (STUB) APPROXIMATELY 30" TO 36" INTO THE GROUND AS SPECIFIED BY THE MANUFACTURER OF THE BREAKAWAY SYSTEM SO THAT NO MORE THAN 4" OF THE GROUND SUPPORT (STUB) EXTENDS ABOVE THE GROUND. REMOVE ENOUGH SOIL FROM AROUND THE GROUND SUPPORT (STUB) TO PERMIT ACCESS TO THE HOLES FOR THE INSERTION AND TIGHTENING OF THE LOWER BOLT OF THE BREAKAWAY SYSTEM. UPON COMPLETING THE INSTALLATION OF THE BREAKAWAY SYSTEM, REPLACE THE SOIL AND TAMP.

INSTALL THE BREAKAWAY SYSTEM TO FUNCTION IN ACCORDANCE WITH THE DIRECTION OF TRAFFIC IN THE ADJACENT TRAVEL LANE. INSTALL THE GROUND SUPPORT (STUB) BETWEEN THE SIGN SUPPORT AND THE APPROACHING TRAFFIC IN THE ADJACENT TRAVEL LANE.

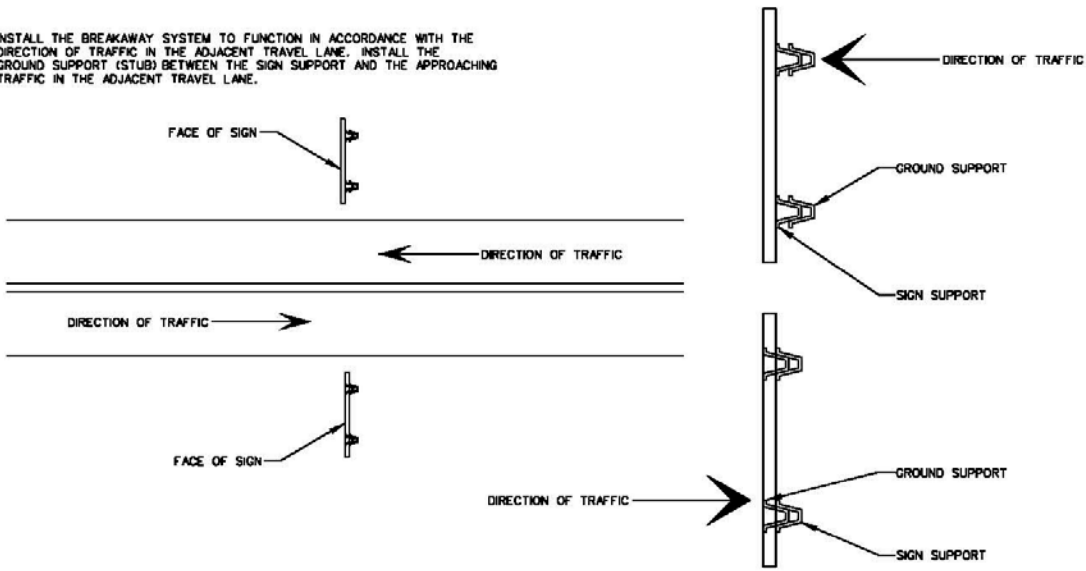

**WORK ZONE SIGNING
GROUND MOUNTED U-CHANNEL POSTS
U-CHANNEL SPLICE**

1. These requirements apply to work zone traffic control advance warning sign installations on u-channel posts.
2. These illustrations regarding u-channel post splices are intended for information ONLY. Similarity between the illustrations and any specific device or system is coincidental and is not intended as either a recommendation or an endorsement of a specific device or design.
3. All breakaway system hardware, including bolts, nuts, washers and spacers illustrated are typical and may vary in size, number, configuration and overall design in accordance with each specific manufacturer's design.
4. A u-channel post splice is only acceptable in locations where a standard length u-channel post is insufficient to meet the installation requirements for ground mounted signs attached to u-channel posts. A u-channel post splice installation shall meet the following requirements:
 - A. Overlap the two sections of u-channel posts a length of 18 inches for the splice. Attach the overlapped sections of u-channel posts with two 5/16" x 1 1/2" standard grade 9 hex head bolts with self-locking flange nuts and grade 9 cut washers at each end of the splice.
 - B. The lower sign support is always between oncoming traffic and the upper sign support. Overlap the upper sign support to the side of the lower support opposite of oncoming traffic.
 - C. Install the splice at a minimum height of 5 feet from the bottom edge of the splice to the grade elevation of the near edge of the adjacent travel lane.
5. The mounting height for regulatory and advance warning sign assemblies mounted on ground mounted u-channel posts is measured from the bottom edge of the primary sign to the grade elevation of the near edge of the adjacent travel lane. The mounting height of these signs should be 7 feet to 8 feet.

The minimum mounting height for a detour sign assembly with multiple sign panels mounted on a ground mounted u-channel post is no less than 5 feet from the grade elevation of the near edge of the adjacent travel lane to the bottom of the route sign or the detour sign panel (M4-9) unless otherwise directed by the Department.

DRAWING 105-20
 WORK ZONE SIGNING
 GROUND MOUNTED
 U-CHANNEL POSTS
 U-CHANNEL
 SPLICE

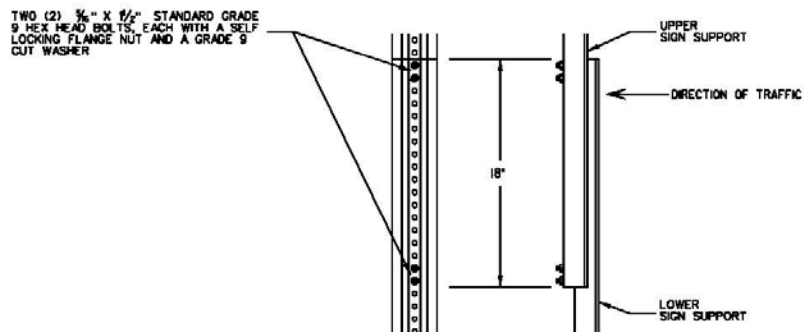
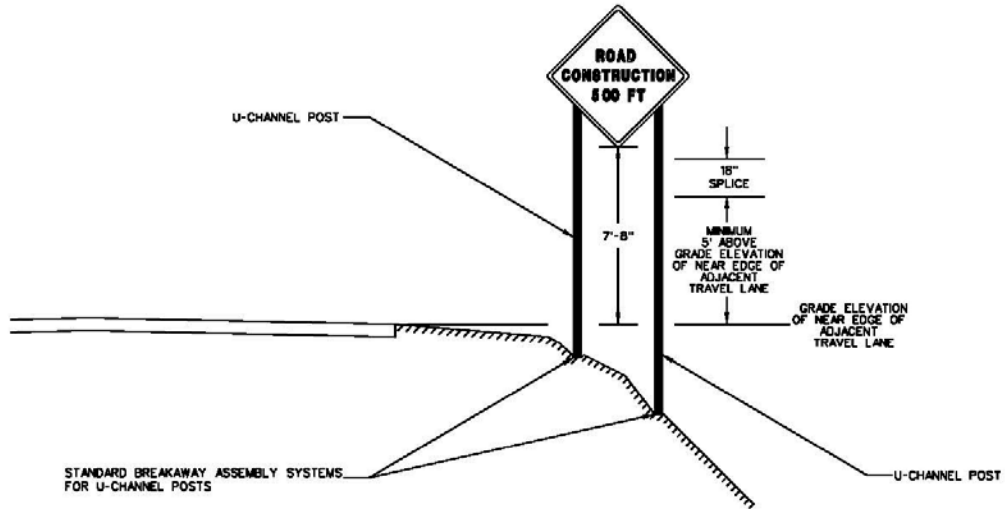

**WORK ZONE SIGNING
SQUARE STEEL TUBE POSTS
12 GAUGE / 14 GAUGE SIGN SUPPORTS
12 GAUGE GROUND SUPPORT
DIRECT EMBEDMENT**

1. These requirements apply to work zone traffic control advance warning sign installation assemblies containing a sign or signs attached to two or more square steel tube post sign supports. The sign supports may be inserted into ground supports or directly embedded into the ground.
2. The sign supports for a dual post sign assembly installation may be either 12 gauge or 14 gauge 2 inch by 2 inch square steel tube posts. Each square steel tube sign support in the same sign assembly installation shall be of the same gauge. Utilizing both 12-gauge and 14-gauge 2 inch by 2 inch square steel tube posts as sign supports in the same sign assembly installation is PROHIBITED.
3. The ground supports for a dual post sign assembly installation shall be 12 gauge 2 ¼ inch by 2 ¼ inch square steel tube posts. A ground support shall have a minimum length of 30 inches with a minimum embedment depth of 28 inches and a maximum exposure length above the ground surface of no more than 2 inches.
Insert the 2 inch by 2 inch sign support no less than 8 inches into the 2 ¼ inch by 2 ¼ inch ground support.
4. When utilizing the direct embedment method, both 12-gauge and 14-gauge 2 inch by 2 inch square steel tube posts utilized for sign supports are acceptable. The minimum embedment depth of these sign supports is 36 inches.
5. The mounting height for signs mounted on ground mounted square steel tube posts is measured from the bottom edge of the primary sign to the grade elevation of the near edge of the adjacent travel lane. The mounting height for work zone traffic control regulatory and advance warning sign assemblies should be 7 feet to 8 feet.

DUAL POST SIGN ASSEMBLY

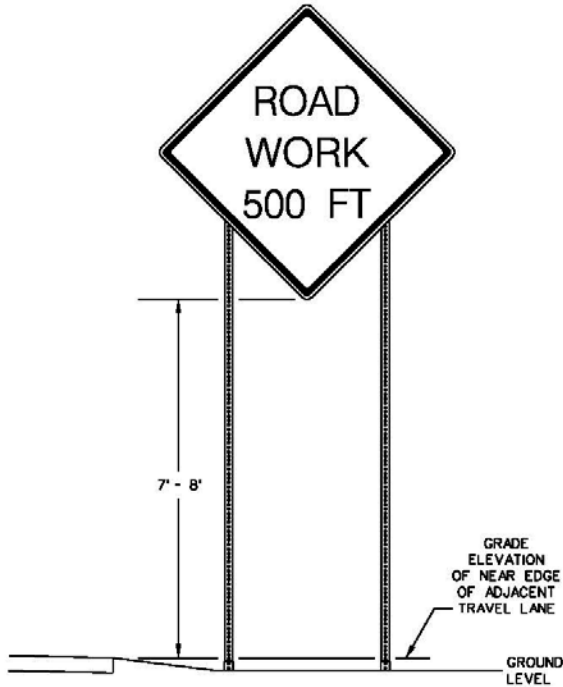

DRAWING 105-30
 WORK ZONE SIGNING
 SQUARE STEEL TUBE POSTS
 12 GA. / 14 GA.
 SIGN SUPPORTS
 12 GA. GROUND SUPPORT
 DIRECT EMBEDMENT

SIGN SUPPORT ATTACHMENT
 TO
 GROUND SUPPORT

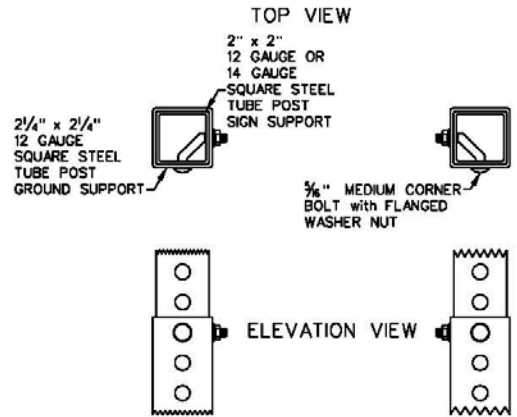

SECURE THE SQUARE STEEL TUBE POST SIGN SUPPORT TO THE SQUARE STEEL TUBE POST GROUND SUPPORT WITH A 3/8" MEDIUM CORNER BOLT AND FLANGED WASHER NUT.

DUAL POST SIGN ASSEMBLY
 BREAKAWAY ANCHOR
 2 1/4" x 2 1/4"
 12 GAUGE GROUND SUPPORT

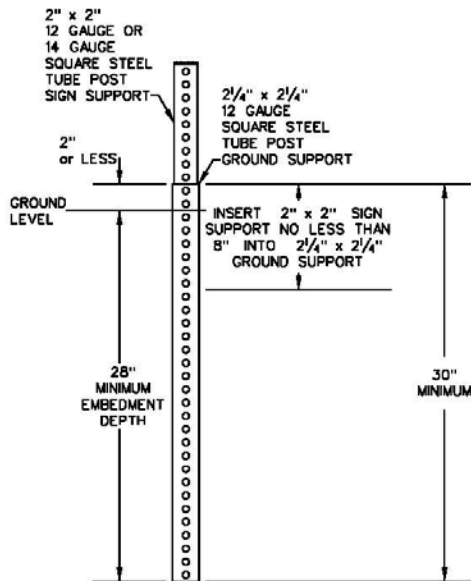

28" MINIMUM EMBEDMENT OF THE 2 1/4" x 2 1/4" 12 GAUGE SQUARE STEEL TUBE POST GROUND SUPPORT IS REQUIRED.

DUAL POST SIGN ASSEMBLY
 DIRECT EMBEDMENT

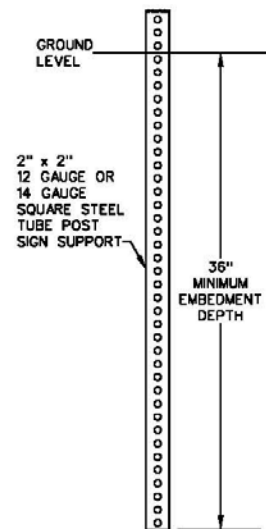

36" MINIMUM EMBEDMENT OF A SQUARE STEEL TUBE POST SIGN SUPPORT IS REQUIRED FOR A DIRECT EMBEDMENT INSTALLATION.

**WORK ZONE SIGNING
SQUARE STEEL TUBE POSTS
TYPICAL SINGLE POST INSTALLATIONS
SIGN PANEL SQUARE FOOTAGE OF 14 SQUARE FEET OR LESS**

1. These requirements apply to work zone traffic control advance warning sign installation assemblies with 14 square feet or less of sign panels attached to a single square steel tube post sign support. The total square footage of sign panels attached to a single 2 inch by 2 inch 12 gauge sign support shall not exceed 14 square feet.
The single sign support may be inserted into a ground support or directly embedded into the ground.
2. The sign support for this single post sign assembly installation shall be a 12 gauge 2 inch by 2 inch square steel tube post. Utilizing a 14 gauge 2 inch by 2 inch square steel tube post as a sign support in a single post sign assembly installation is PROHIBITED.
3. The ground support for a single post sign assembly installation with a sign panel square footage of 14 square feet or less shall be a 12 gauge 2 ¼ inch by 2 ¼ inch square steel tube post. The ground support shall have a minimum length of 30 inches with a minimum embedment depth of 28 inches and a maximum exposure length above the ground surface of no more than 2 inches.
Insert the 2 inch by 2 inch sign support no less than 8 inches into the 2 ¼ inch by 2 ¼ inch ground support.
4. When utilizing the direct embedment method for a single post sign assembly installation with a sign panel square footage of 14 square feet or less, 12 gauge 2 inch by 2 inch square steel tube posts are required for sign supports. The minimum embedment depth of the sign support is 36 inches.
5. The minimum mounting height for ground mounted detour sign assemblies with multiple sign panels is 5 feet from the grade elevation of the near edge of the adjacent travel lane to the bottom of the route sign or the detour sign panel (M4-9) unless otherwise directed by the Department.

**SINGLE POST SIGN ASSEMBLY
14 SQUARE FEET OR LESS**

2" x 2" 12 GAUGE SIGN SUPPORT
SECURED TO A
2 1/4" x 2 1/4" 12 GAUGE GROUND SUPPORT

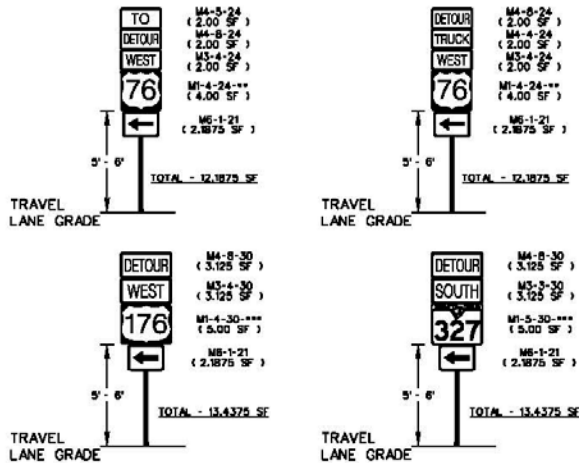

THE TOTAL SQUARE FOOTAGE OF SIGN PANELS ATTACHED TO A SINGLE 2" x 2" 12 GAUGE SIGN SUPPORT SECURED TO A 2 1/4" x 2 1/4" 12 GAUGE GROUND SUPPORT SHALL NOT EXCEED 14 SQUARE FEET. THESE SIGN ASSEMBLY ILLUSTRATIONS ARE TYPICAL APPLICATIONS PROVIDED FOR INFORMATION TO ILLUSTRATE SQUARE FOOTAGE TOTALS FOR THESE TYPES OF SIGN ASSEMBLY INSTALLATIONS.

SPECIAL NOTE:
THE MINIMUM MOUNTING HEIGHT FOR GROUND MOUNTED DETOUR SIGN ASSEMBLIES WITH MULTIPLE SIGN PANELS IS 5' FROM THE GRADE ELEVATION OF THE NEAR EDGE OF THE ADJACENT TRAVEL LANE TO THE BOTTOM OF THE ROUTE SIGN OR THE DETOUR SIGN PANEL (M4-9) UNLESS OTHERWISE DIRECTED BY THE DEPARTMENT. THE MINIMUM MOUNTING HEIGHT FOR ALL OTHER GROUND MOUNTED SIGNS IS 7' UNLESS OTHERWISE DIRECTED BY THE DEPARTMENT.

**DRAWING 105-40
WORK ZONE SIGNING
SQUARE STEEL TUBE POSTS
TYPICAL SINGLE POST INSTALLATIONS
SIGN PANEL SQUARE FOOTAGE OF
14 SQUARE FT. OR LESS**

**SIGN SUPPORT ATTACHMENT
TO
GROUND SUPPORT**

TOP VIEW

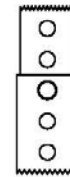
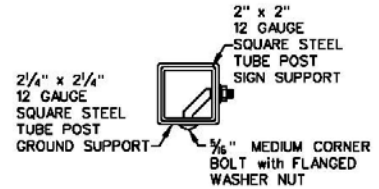

ELEVATION VIEW

SECURE THE SQUARE STEEL TUBE POST SIGN SUPPORT TO THE SQUARE STEEL TUBE POST GROUND SUPPORT WITH A 3/8" MEDIUM CORNER BOLT AND FLANGED WASHER NUT.

**SINGLE POST BREAKAWAY ANCHOR
FOR
SIGN PANELS 14 SQUARE FEET OR LESS
2 1/4" x 2 1/4" 12 GAUGE GROUND SUPPORT**

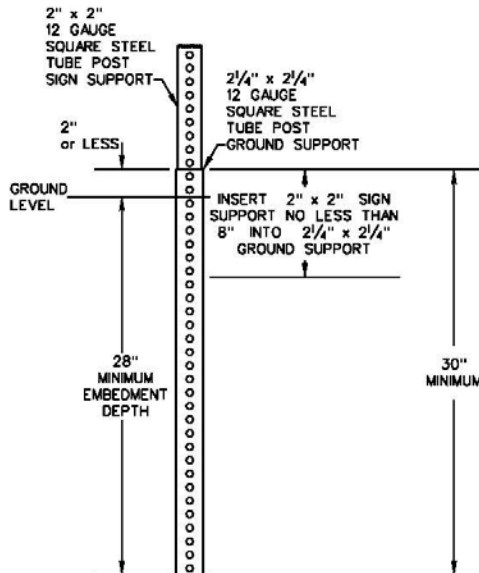

28" MINIMUM EMBEDMENT OF THE 2 1/4" x 2 1/4" 12 GAUGE SQUARE STEEL TUBE POST GROUND SUPPORT IS REQUIRED.

**SINGLE POST DIRECT EMBEDMENT
FOR
SIGN PANELS 14 SQUARE FEET OR LESS**

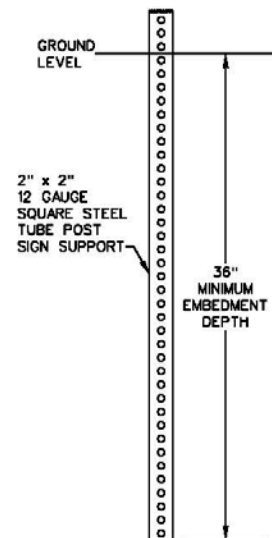

36" MINIMUM EMBEDMENT OF A SQUARE STEEL TUBE POST SIGN SUPPORT IS REQUIRED FOR A DIRECT EMBEDMENT INSTALLATION.

**WORK ZONE SIGNING
SQUARE STEEL TUBE POSTS
SINGLE POST INSTALLATIONS
12 GAUGE SIGN SUPPORT
7 GAUGE BREAKAWAY ANCHORS
SIGN PANELS GREATER THAN 14 SQUARE FEET UP TO 20 SQUARE FEET**

1. These requirements apply to work zone traffic control advance warning sign installation assemblies with a sign panel square footage no greater than 20 square feet attached to a single 2 ½ inch by 2 ½ inch 12 gauge square steel tube post sign support. The total square footage of sign panels attached this sign support should be greater than 14 square feet but shall not exceed 20 square feet.

Insert the single sign support into a 3 inch by 3 inch 7 gauge structural steel ground support. Direct embedment of this single post sign support into the ground is PROHIBITED.

2. The ground support for this single post sign assembly installation shall be either a 7 gauge 3 inch by 3 inch by 36 inch structural square steel tube or a 7 gauge 3 inch by 3 inch by 3/16 inch by 36 inch structural steel angle supplemented with a 3 inch by 3 inch by 12 inch structural square steel tube. Drive each anchor type into the ground to the necessary depth that will result in a maximum exposure length above the ground surface of no more than 3 inches.

Insert the 2 ½ inch by 2 ½ inch sign support no less than 8 inches into the 3 inch by 3 inch ground support.

3. The mounting height for regulatory and advance warning sign assemblies attached to a single 2 ½ inch by 2 ½ inch 12 gauge square steel tube post sign support shall be 7 feet to 8 feet from the grade elevation of the near edge of the adjacent travel lane to the bottom of the primary sign panel.

The minimum mounting height for guide signs, including detour sign assemblies with multiple sign panels, attached to a single 2 ½ inch by 2 ½ inch 12 gauge square steel tube post sign support should be no less than 5 feet from the grade elevation of the near edge of the adjacent travel lane to the bottom of the route sign or the detour sign panel (M4-9) unless otherwise directed by the Department.

SINGLE POST SIGN ASSEMBLY
BREAKAWAY ANCHOR
3" x 3"
7 GAUGE STRUCTURAL SQUARE STEEL TUBE

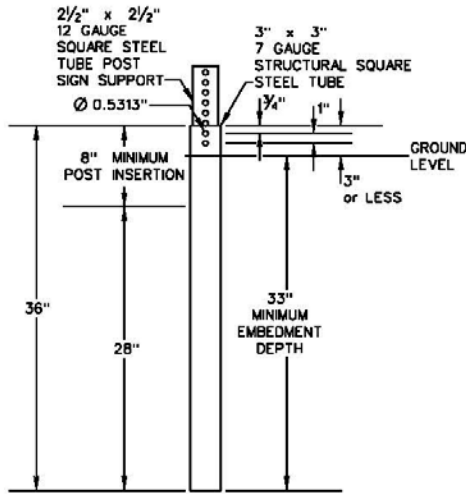

7 GAUGE SQUARE STEEL TUBE ANCHOR MATERIAL REQUIREMENTS:
3" x 3" x 36" A500 GRADE B STRUCTURAL TUBE -
46,000 PSI MINIMUM YIELD STRENGTH
56,000 PSI MINIMUM TENSILE STRENGTH
HOT DIP GALVANIZED PER ASTM A123

TOP VIEW

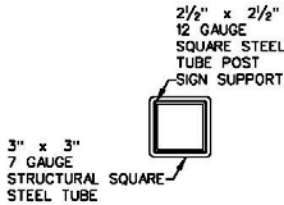

POST TO ANCHOR FASTENER

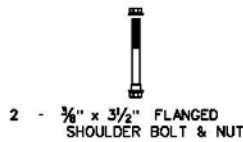

SIGN SUPPORT ATTACHMENT
TO
BREAKAWAY ANCHOR

TOP VIEW



ELEVATION VIEW



GENERAL NOTES:-

- TWO GROUND SUPPORT BREAKAWAY ANCHOR OPTIONS ARE AVAILABLE FOR A SINGLE POST SIGN MOUNT SYSTEM:
 - 3" x 3" x 36" 7 GAUGE STRUCTURAL STEEL TUBE
 - 3" x 3" x 3/16" x 36" 7 GAUGE STRUCTURAL STEEL ANGLE
- DRIVE THE GROUND SUPPORT BREAKAWAY ANCHOR TO A DEPTH THAT WILL EXPOSE NO MORE THAN 3 INCHES OF THE ANCHOR ABOVE GROUND LEVEL.
- UTILIZE A 2 1/2" x 2 1/2" 12 GAUGE STEEL TUBE POST FOR THE SIGN SUPPORT OF A SINGLE POST SIGN MOUNT SYSTEM.
- THE SQUARE FOOTAGE OF SIGN PANELS ATTACHED TO A SINGLE 2 1/2" x 2 1/2" 12 GAUGE SIGN SUPPORT SECURED TO A 3" x 3" 7 GAUGE BREAKAWAY ANCHOR SHALL NOT EXCEED 20 SQUARE FEET.
- INSERT THE 2 1/2" x 2 1/2" 12 GAUGE SQUARE STEEL TUBE POST SIGN SUPPORT INTO THE GROUND SUPPORT BREAKAWAY ANCHOR A MINIMUM DEPTH OF 8 INCHES.

DRAWING 105-50
WORK ZONE SIGNING
SQUARE STEEL TUBE POSTS
SINGLE POST INSTALLATIONS
12 GA. SIGN SUPPORT
7 GA. BREAKAWAY ANCHORS
SIGN PANELS >14 SQUARE FEET
UP TO 20 SQUARE FEET

SINGLE POST SIGN ASSEMBLY
BREAKAWAY ANCHOR
3" x 3" x 3/16"
7 GAUGE STRUCTURAL STEEL ANGLE

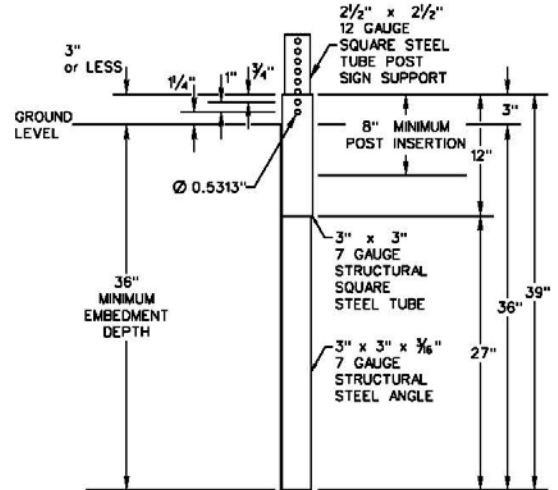

7 GAUGE STRUCTURAL SQUARE STEEL ANGLE ANCHOR MATERIAL REQUIREMENTS:
3" x 3" x 3/16" x 36" A36 STRUCTURAL STEEL ANGLE -
HOT DIP GALVANIZED PER ASTM A123
3" x 3" x 12" A500 GRADE B STRUCTURAL TUBE -
46,000 PSI MINIMUM YIELD STRENGTH
58,000 PSI MINIMUM TENSILE STRENGTH
HOT DIP GALVANIZED PER ASTM A123

TOP VIEW

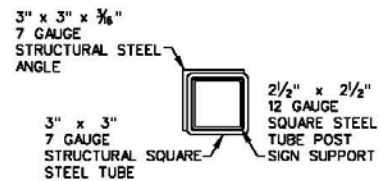

POST TO ANCHOR FASTENER



SIGN SUPPORT ATTACHMENT
TO
BREAKAWAY ANCHOR

TOP VIEW



ELEVATION VIEW

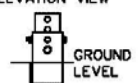

**WORK ZONE SIGNING
SQUARE STEEL TUBE POSTS
TYPICAL SINGLE POST INSTALLATIONS
SIGN PANELS GREATER THAN 14 SQUARE FEET UP TO 20 SQUARE FEET**

1. These requirements apply to work zone traffic control advance warning sign installation assemblies with sign panel square footage greater than 14 square feet up to 20 square feet attached to a single 2 ½ inch by 2 ½ inch 12 gauge square steel tube post sign support. The total square footage of sign panels attached this sign support should be greater than 14 square feet but shall not exceed 20 square feet.

Insert the single sign support into a 3 inch by 3 inch 7 gauge structural steel ground support. Direct embedment of this single post sign support into the ground is PROHIBITED.

2. The ground support for this single post sign assembly installation shall be either a 7 gauge 3 inch by 3 inch by 36 inch structural square steel tube or a 7 gauge 3 inch by 3 inch by 3/16 inch by 36 inch structural steel angle supplemented with a 3 inch by 3 inch by 12 inch structural square steel tube. Drive each anchor type into the ground to the necessary depth that will result in a maximum exposure length above the ground surface of no more than 3 inches.

Insert the 2 ½ inch by 2 ½ inch sign support no less than 8 inches into the 3 inch by 3 inch ground support.

3. The mounting height for regulatory and advance warning sign assemblies attached to a single 2 ½ inch by 2 ½ inch 12 gauge square steel tube post sign support shall be 7 feet to 8 feet from the grade elevation of the near edge of the adjacent travel lane to the bottom of the primary sign panel.

The minimum mounting height for guide signs, including detour sign assemblies with multiple sign panels, attached to a single 2 ½ inch by 2 ½ inch 12 gauge square steel tube post sign support should be no less than 5 feet from the grade elevation of the near edge of the adjacent travel lane to the bottom of the route sign or the detour sign panel (M4-9) unless otherwise directed by the Department.

DRAWING 105-60
 WORK ZONE SIGNING
 SQUARE STEEL TUBE POSTS
 TYPICAL SINGLE POST INSTALLATIONS
 SIGN PANELS >14 SQUARE FEET
 UP TO 20 SQUARE FEET

SINGLE POST SIGN ASSEMBLY
 > 14 SQUARE FEET UP TO 20 SQUARE FEET

2 1/2" x 2 1/2" 12 GAUGE SIGN SUPPORT
 SECURED TO A
 3" x 3" 7 GAUGE BREAKAWAY ANCHOR

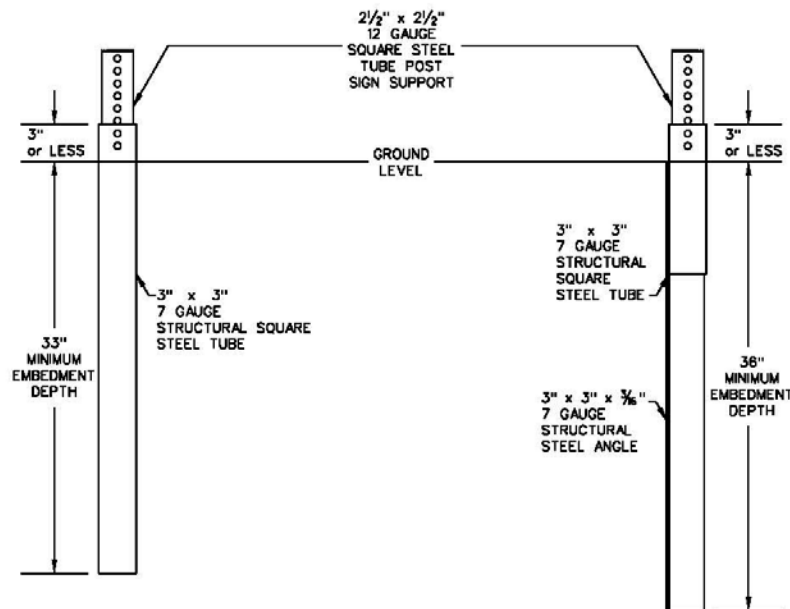
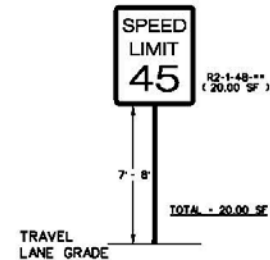
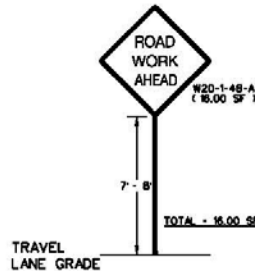
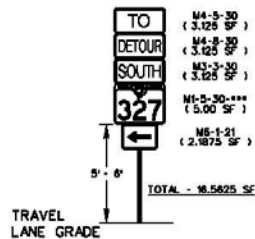
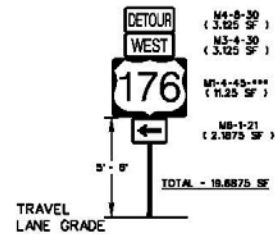
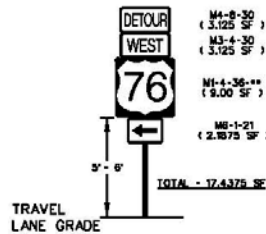
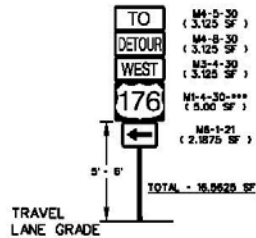

THE TOTAL SQUARE FOOTAGE OF SIGN PANELS ATTACHED TO A SINGLE 2 1/2" x 2 1/2" 12 GAUGE SIGN SUPPORT SECURED TO A 3" x 3" 7 GAUGE BREAKAWAY ANCHOR SHOULD BE GREATER THAN 14 SQUARE FEET BUT SHALL NOT EXCEED 20 SQUARE FEET. THESE SIGN ASSEMBLY ILLUSTRATIONS ARE TYPICAL APPLICATIONS PROVIDED FOR INFORMATION TO ILLUSTRATE TYPICAL SQUARE FOOTAGE TOTALS FOR THESE TYPES OF SIGN ASSEMBLY INSTALLATIONS.

SPECIAL NOTE:
 THE MINIMUM MOUNTING HEIGHT FOR GROUND MOUNTED GUIDE SIGN ASSEMBLIES, INCLUDING DETOUR SIGN ASSEMBLIES, WITH MULTIPLE SIGN PANELS SHOULD BE NO LESS THAN 5 FEET FROM THE GRADE ELEVATION OF THE NEAR EDGE OF THE ADJACENT TRAVEL LANE TO THE BOTTOM OF THE ROUTE SIGN OR THE DETOUR SIGN PANEL (M4-8). THE MINIMUM MOUNTING HEIGHT FOR REGULATORY AND ADVANCE WARNING SIGN ASSEMBLIES SHOULD BE NO LESS THAN 7 FEET FROM THE GRADE ELEVATION OF THE NEAR EDGE OF THE ADJACENT TRAVEL LANE TO THE BOTTOM OF THE PRIMARY SIGN PANEL.

LANE CLOSURES

***INSTALLATION
&
REMOVAL***

STANDARD DRAWING NO. 305-01-A

Through

STANDARD DRAWING NO. 305-03

Drawing Nos. 305-01-A
305-01-B
305-02
305-03

**LANE CLOSURE
INSTALLATION & REMOVAL
MULTILANE
PRIMARY & SECONDARY ROUTES
INTERSTATE ROUTES**

Installation

1. **When installing or removing the advance warning and transition areas of a lane closure on a high speed high volume route, a shadow vehicle supplemented with a truck mounted advance warning arrow panel and a truck mounted attenuator is required to follow the work vehicle unless otherwise directed.** Additional shadow vehicles are optional. The shadow vehicle should utilize the same portion of the travel lane and the shoulder area as the work vehicle and shall operate in the same direction of traffic.
However, when more than 1 shadow vehicle is used, the initial shadow vehicle encountered by approaching motorists may be supplemented with either a truck mounted advance warning arrow panel or a truck mounted changeable message sign. When a truck mounted changeable message sign is utilized, always supplement the initial shadow vehicle encountered by approaching motorists with the truck mounted changeable message sign and supplement all subsequent shadow vehicles with truck mounted advance warning arrow panels.
2. Install the advance warning area. Install the advance warning signs in the shoulder area opposite of the travel lane intended for closure. During this installation process, the work vehicle should utilize the shoulder area when available and practical. The shadow vehicle should operate in the same portion of the travel lane and the shoulder area as the work vehicle. The work vehicle and the shadow vehicle shall travel and operate in the same direction of traffic.
3. Continue the installation of the advance warning area. Upon completion of the installation of the advance warning signs in the shoulder area opposite of the travel lane intended for closure, install the advance warning signs in the shoulder area adjacent to the travel lane intended for closure. During this installation process, the work vehicle should utilize the shoulder area when available and practical. The shadow vehicle should operate in the same portion of the travel lane and the shoulder area as the work vehicle. The work vehicle and the shadow vehicle shall travel and operate in the same direction of traffic.
4. When a trailer mounted changeable message sign is required as a component of the advance warning sign array, install the trailer mounted changeable message sign upon completion of the installation of the static advance warning signs in the shoulder area. Conduct this installation process in a manner to allow the work vehicle and the shadow vehicle to operate and utilize as much of the shoulder area as practical and minimize encroachment onto the adjacent travel lane. The work vehicle and the shadow vehicle shall travel and operate in the same direction of traffic.
5. Upon completion of the installation of the advance warning area, install the transition area which consists of the taper. Install the traffic control devices composing the taper. The work vehicle and the shadow vehicle shall operate in the travel lane intended for closure. The work vehicle shall travel through the transition area in the same direction of traffic while deploying the traffic control devices that will compose the taper. The shadow vehicle should remain within the travel lane intended for closure no further than 100 feet in advance of the beginning of the taper as the work vehicle progresses through the transition area while deploying the traffic control devices.
6. Upon completion of the installation of the transition area, install the activity area which consists of the tangent portion of the lane closure and the work area. The work vehicle shall progress through the activity area in the same direction of traffic while deploying the traffic control devices that will compose the tangent portion of the lane closure. **A shadow vehicle is not required during this operation when the work vehicle is operating within the limits of the closed travel lane.**

Removal

1. Remove the activity area. Remove the traffic control devices that delineate the tangent portion of the lane closure. Remove these traffic control devices in the opposite direction traveled by the work vehicle during deployment of these traffic control devices. Begin the removal process of these traffic control devices at the downstream end of the activity area and progress toward the downstream end of the taper. The work vehicle shall travel and operate within the closed travel lane in the opposite direction of traffic. **A shadow vehicle is not required during this operation when the work vehicle is operating within the limits of the closed travel lane.**

When conducting these removal operations during the hours of darkness, operate the work vehicle as far away from the near edge of the adjacent travel lane open to traffic as practical.

2. Upon completion of the removal of the tangent portion of the lane closure, remove the transition area which consists of the taper. **The work vehicle and the shadow vehicle shall operate in the same travel lane containing the taper and in the same direction of traffic during the removal of the taper. Do not operate against the flow of traffic during the removal of the taper.** Remove the traffic control devices composing the taper in the same direction of traffic. The shadow vehicle shall operate in advance of the beginning of the taper. The shadow vehicle shall operate no further than 100 feet in advance of the work vehicle as the work vehicle recovers the traffic control devices.

3. When trailer mounted changeable message sign is present, remove the trailer mounted changeable message sign upon completion of the removal of the taper. Remove the trailer mounted changeable message sign prior to beginning the removal of the static advance warning signs. Conduct this removal process in a manner to allow the work vehicle and the shadow vehicle to operate and utilize as much of the shoulder area as practical and minimize encroachment onto the adjacent travel lane. The work vehicle and the shadow vehicle shall travel and operate in the same direction of traffic.

4. Upon completion of the removal of the changeable message sign, remove the advance warning area. Remove the advance warning signs in the shoulder area adjacent to the travel lane subjected to the previous closure. Remove these advance warning signs in the same direction of traffic. During this removal process, the work vehicle should utilize the shoulder area when available and practical. The shadow vehicle should operate in the same portion of the travel lane and the shoulder area as the work vehicle. The work vehicle and the shadow vehicle shall operate in the same direction of traffic and shall progress through the advance warning area in the same direction of traffic while removing the advance warning signs.

5. Continue the removal of the advance warning area. Remove the advance warning signs in the shoulder area opposite of the travel lane subjected to the previous closure. Remove these advance warning signs in the same direction of traffic. During this removal process, the work vehicle should utilize the shoulder area when available and practical. The shadow vehicle should operate in the same portion of the travel lane and the shoulder area as the work vehicle. The work vehicle and the shadow vehicle shall operate in the same direction of traffic and shall progress through the advance warning area in the same direction of traffic while removing the advance warning signs.

DRAWING 305-01-A
 LANE CLOSURE
 INSTALLATION & REMOVAL
 MULTILANE
 PRIMARY & SECONDARY ROUTES
 INTERSTATE ROUTES
 LEFT LANE / LEFT SHOULDER
 ADVANCE WARNING AREA
 STEP 1 INSTALLATION /
 STEP 4 REMOVAL

THE ILLUSTRATED SIGN INSTALLATIONS ARE TYPICAL. SPECIFIC SIGN INSTALLATIONS SHALL COMPLY WITH SPECIFIC LANE CLOSURE REQUIREMENTS.

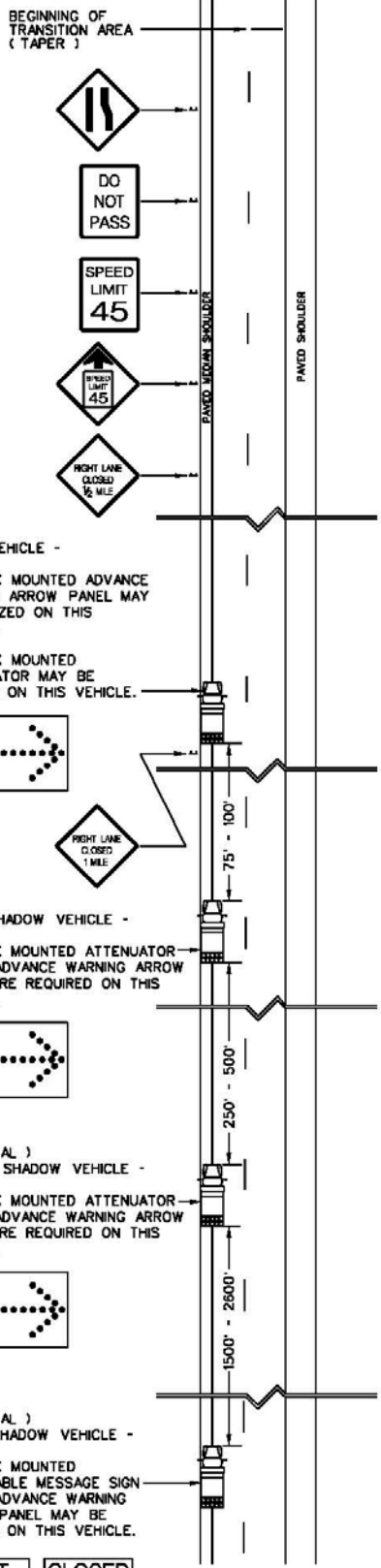

WORK VEHICLE -
 A TRUCK MOUNTED ADVANCE WARNING ARROW PANEL MAY BE UTILIZED ON THIS VEHICLE.

A TRUCK MOUNTED ATTENUATOR MAY BE UTILIZED ON THIS VEHICLE.

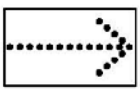

FIRST SHADOW VEHICLE -
 A TRUCK MOUNTED ATTENUATOR & AN ADVANCE WARNING ARROW PANEL ARE REQUIRED ON THIS VEHICLE.

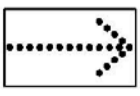

(OPTIONAL)
 SECOND SHADOW VEHICLE -
 A TRUCK MOUNTED ATTENUATOR & AN ADVANCE WARNING ARROW PANEL ARE REQUIRED ON THIS VEHICLE.



(OPTIONAL)
 INITIAL SHADOW VEHICLE -
 A TRUCK MOUNTED CHANGEABLE MESSAGE SIGN OR AN ADVANCE WARNING ARROW PANEL MAY BE UTILIZED ON THIS VEHICLE.



A TRUCK MOUNTED ATTENUATOR IS REQUIRED ON THIS VEHICLE.

DRAWING 305-01-B
 LANE CLOSURE
 INSTALLATION & REMOVAL
 MULTILANE
 PRIMARY & SECONDARY ROUTES
 INTERSTATE ROUTES
 RIGHT LANE / RIGHT SHOULDER
 ADVANCE WARNING AREA
 STEP 2 INSTALLATION /
 STEP 3 REMOVAL

THE ILLUSTRATED SIGN INSTALLATIONS ARE TYPICAL. SPECIFIC SIGN INSTALLATIONS SHALL COMPLY WITH SPECIFIC LANE CLOSURE REQUIREMENTS.

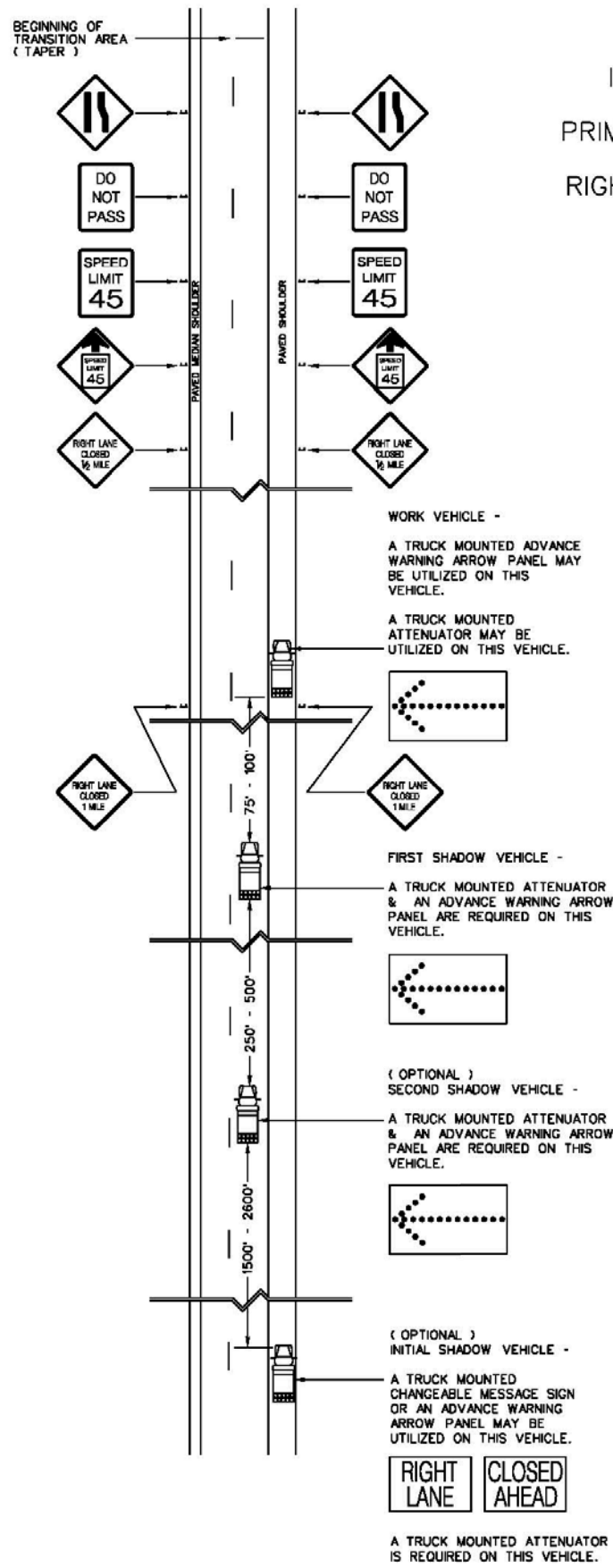

*** LEFT LANE OPERATIONS**

WHEN THE VEHICLE TRAIN IS OPERATING IN THE LEFT TRAVEL LANE, THE TRUCK MOUNTED CHANGEABLE MESSAGE SIGN SHALL FLASH ALTERNATELY TO READ, "LEFT LANE", "CLOSED AHEAD".

**DRAWING 305-02
LANE CLOSURE
INSTALLATION & REMOVAL
MULTILANE
PRIMARY & SECONDARY ROUTES
INTERSTATE ROUTES
TRANSITION AREA
STEP 3 INSTALLATION /
STEP 2 REMOVAL**

THE ILLUSTRATED SIGN AND TRAFFIC CONTROL DEVICES INSTALLATIONS ARE TYPICAL. SPECIFIC SIGN AND TRAFFIC CONTROL DEVICES INSTALLATIONS SHALL COMPLY WITH SPECIFIC LANE CLOSURE REQUIREMENTS.

WORK VEHICLE -
A TRUCK MOUNTED ADVANCE WARNING ARROW PANEL MAY BE UTILIZED ON THIS VEHICLE.
A TRUCK MOUNTED ATTENUATOR MAY BE UTILIZED ON THIS VEHICLE.



FIRST SHADOW VEHICLE -
A TRUCK MOUNTED ATTENUATOR & AN ADVANCE WARNING ARROW PANEL ARE REQUIRED ON THIS VEHICLE.

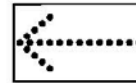

(OPTIONAL)
SECOND SHADOW VEHICLE -
A TRUCK MOUNTED ATTENUATOR & AN ADVANCE WARNING ARROW PANEL ARE REQUIRED ON THIS VEHICLE.



(OPTIONAL)
INITIAL SHADOW VEHICLE -
A TRUCK MOUNTED CHANGEABLE MESSAGE SIGN OR AN ADVANCE WARNING ARROW PANEL MAY BE UTILIZED ON THIS VEHICLE.



A TRUCK MOUNTED ATTENUATOR IS REQUIRED ON THIS VEHICLE.



TRANSITION AREA
(TAPER)

DRAWING 305-03
 LANE CLOSURE
 INSTALLATION & REMOVAL
 MULTILANE
 PRIMARY & SECONDARY ROUTES
 INTERSTATE ROUTES
 ACTIVITY AREA
 STEP 4 INSTALLATION /
 STEP 1 REMOVAL

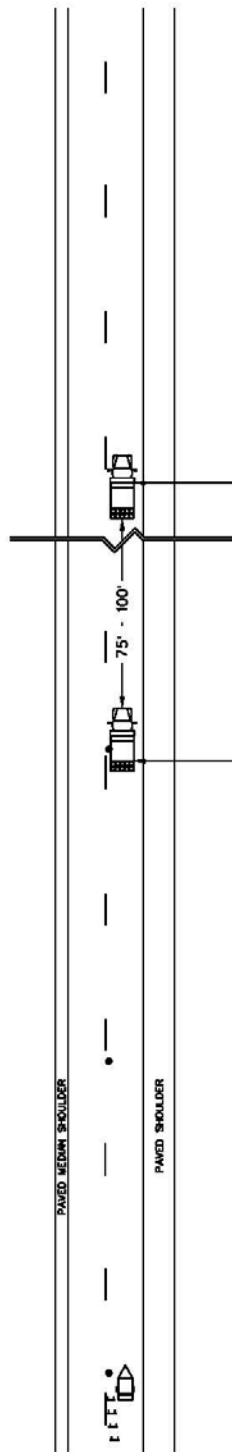

WORK VEHICLE -

A TRUCK MOUNTED ADVANCE WARNING ARROW PANEL MAY BE UTILIZED ON THIS VEHICLE.

A TRUCK MOUNTED ATTENUATOR MAY BE UTILIZED ON THIS VEHICLE.



(OPTIONAL)
 SHADOW VEHICLE -

A TRUCK MOUNTED ATTENUATOR & AN ADVANCE WARNING ARROW PANEL ARE REQUIRED ON THIS VEHICLE.



ACTIVITY AREA
 (WORK AREA)

FLAGGING OPERATIONS

STANDARD DRAWING NO. 405-01-A

Through

STANDARD DRAWING NO. 405-02

**FLAGGING OPERATIONS
MULTIPLE FLAGGERS
TWO-LANE TWO-WAY ROADWAYS
PRIMARY & SECONDARY ROUTES**

1. In the "Work Zone Traffic Control Procedures" section, see the subsection entitled, "Flagging Operations", for the standard requirements regarding all flagging operations.
2. When using a truck mounted attenuator (TMA), the length of the Buffer Space is measured from the downstream end of the Approach Taper to the back of the TMA. When not using a TMA, the length of the Buffer Space is measured from the downstream end of the Approach Taper to the beginning of the Work Activity Area.
3. In accordance with this traffic control setup, install, maintain and conduct multiple flagger flagging operations for a work zone that is present within the travel lane of a two-lane two-way roadway that does not encroach upon an intersection or the approaches of an intersection.
However, when an intersection is involved, see those drawings listed below dependent upon the following scenarios:

SCENARIO	STANDARD DRAWING
Work Activity Area Passes by a Stop Sign Controlled Side Road	Drawing No. 405-01-B(1)
Work Activity Area Passes through a 4-Way Stop Sign Controlled Intersection	Drawing No. 405-01-B(2)
Work Activity Area Passes through a Traffic Signal Controlled Intersection - All Traffic Directed Through the Intersection by Uniformed Law Enforcement Officer(s)	Drawing No. 405-01-C(1)
Work Activity Area Passes through a Traffic Signal Controlled Intersection - All Traffic Directed Through the Intersection by Flaggers	Drawing No. 405-01-C(2)
Work Activity Area Begins at an Intersection with a Two-Lane Two-Way Roadway and is Present within the Departure lane	Drawing No. 405-01-D(1)
Work Activity Area Terminates at an Intersection with a Two-Lane Two-Way Roadway and is Present in the Approach Lane within 900 Feet to 1800 Feet of the Intersection	Drawing No. 405-01-D(2)
Work Activity Area Begins or Terminates at an Intersection with a Low Speed (\leq 35 MPH) Multilane Roadway	Drawing No. 405-01-E(1) Drawing No. 405-01-E(2)
Work Activity Area Begins or Terminates at an Intersection with an Intermediate Speed to High Speed (40 MPH -60 MPH) Multilane Roadway	Drawing No. 405-01-F(1) Drawing No. 405-01-F(2)

DRAWING 405-01-A FLAGGING OPERATIONS MULTIPLE FLAGGERS TWO-LANE TWO-WAY ROADWAYS PRIMARY & SECONDARY ROUTES

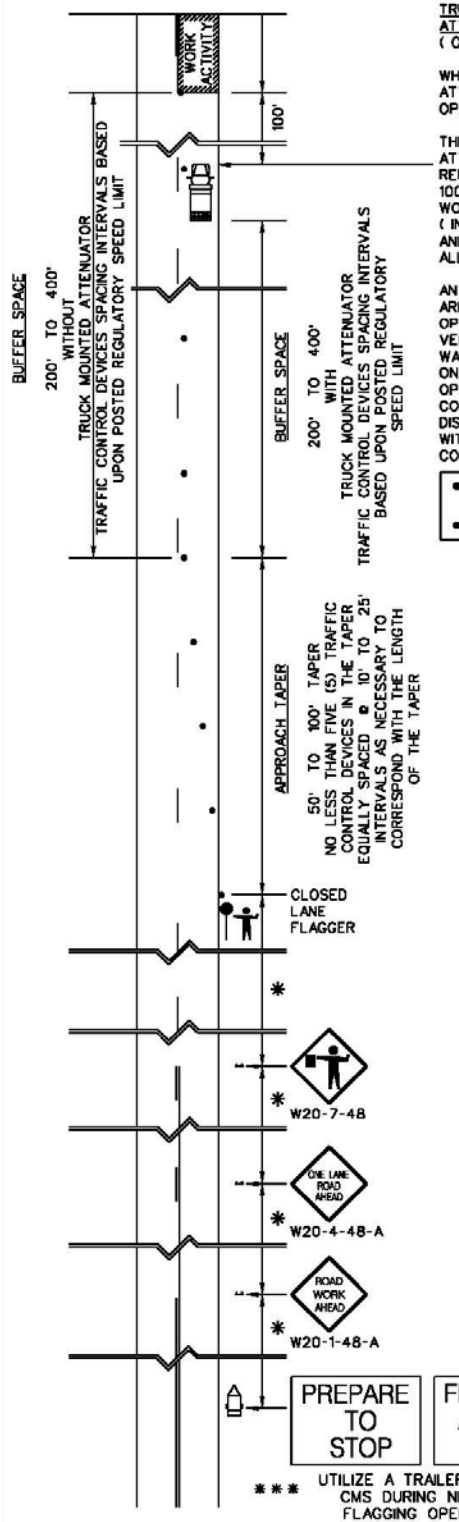

TRUCK MOUNTED ATTENUATOR (OPTIONAL)

WHEN A TRUCK MOUNTED ATTENUATOR IS UTILIZED, OPERATE AS FOLLOWS:

THE TRUCK MOUNTED ATTENUATOR SHALL REMAIN APPROXIMATELY 100' IN ADVANCE OF THE WORK ACTIVITY (INCLUDING PERSONNEL AND MACHINERY) AT ALL TIMES.

AN ADVANCE WARNING ARROW PANEL IS OPTIONAL ON THIS VEHICLE. AN ADVANCE WARNING ARROW PANEL ON THIS VEHICLE SHALL OPERATE IN THE "FOUR CORNER" CAUTION MODE DISPLAYING FOUR LAMPS WITH ONE LAMP IN EACH CORNER.

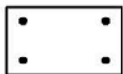

Table A

TRAFFIC CONTROL DEVICE SPACING INTERVALS WORK ACTIVITY AREA	
SPEED LIMIT	SPACING INTERVALS
35 MPH OR LESS	25 FEET
40 MPH OR GREATER	50 FEET

Table B

SIGN PLACEMENT INTERVALS			
SPEED LIMIT	*	*	*
LOW SPEED 35 MPH OR LESS	200	200	200
INTERMEDIATE SPEED 40 - 50 MPH	350	350	350
HIGH SPEED 55 MPH OR GREATER	500	500	500

Table C

BUFFER SPACE DISTANCES	
SPEED LIMIT	DISTANCES
LOW SPEED 35 MPH OR LESS	200
INTERMEDIATE SPEED 40 - 50 MPH	300
HIGH SPEED 55 MPH OR GREATER	400

NOTE: ADJUSTMENTS TO THE BUFFER SPACE DISTANCES MAY BE REQUIRED DUE TO FIELD CONDITIONS.

*** UTILIZE A TRAILER MOUNTED CMS DURING NIGHTTIME FLAGGING OPERATIONS ***

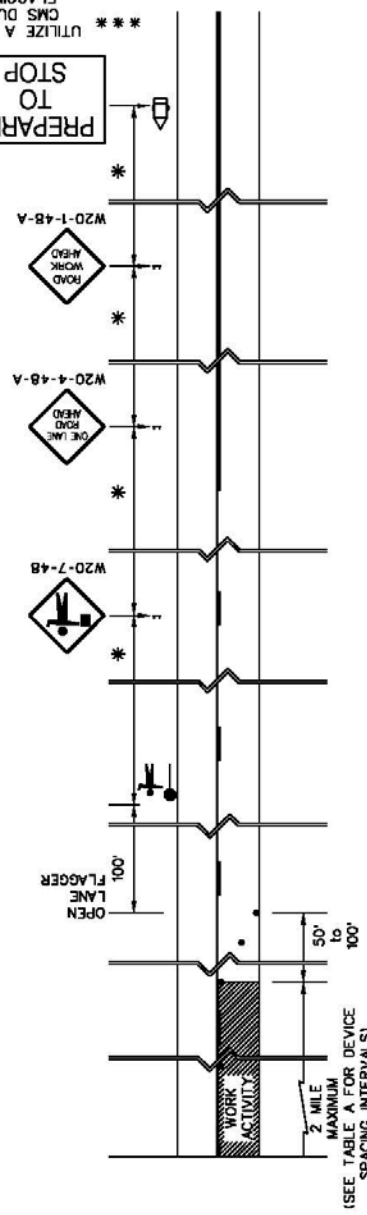

*** UTILIZE A TRAILER MOUNTED CMS DURING NIGHTTIME FLAGGING OPERATIONS ***

NIGHTTIME FLAGGING OPERATIONS

ALL FLAGGERS SHALL WEAR CLASS 3 HIGH VISIBILITY SAFETY APPAREL MEETING ANSI/ISEA 107 REQUIREMENTS.

UTILIZE CHANGEABLE MESSAGE SIGNS ON EACH ROADWAY APPROACH DURING ALL PLANNED NIGHTTIME WORK ACTIVITIES THAT REQUIRE FLAGGING OPERATIONS.

ILLUMINATE EACH FLAGGER STATION.

UTILIZE PORTABLE PLASTIC DRUMS OR 42" OVERSIZED CONES INSTEAD OF STANDARD TRAFFIC CONES.

SPECIAL NOTE:

DURING UNPLANNED NIGHTTIME EMERGENCY OPERATIONS, THE CHANGEABLE MESSAGE SIGNS MAY BE OMITTED. THE REQUIREMENT FOR THE CHANGEABLE MESSAGE SIGNS SHALL BE MAINTAINED FOR ALL PLANNED NIGHTTIME WORK ACTIVITIES THAT REQUIRE FLAGGING OPERATIONS.

(SEE TABLE A FOR DEVICE SPACING INTERVALS)

**FLAGGING OPERATIONS
MULTIPLE FLAGGERS
TWO-LANE TWO-WAY ROADWAYS
PRIMARY & SECONDARY ROUTES
STOP SIGN CONTROLLED
SIDE ROADS**

1. See "Work Zone Traffic Control Procedures, Flagging Operations" for standard requirements regarding all flagging operations.
2. In accordance with this traffic control setup, install, maintain and conduct multiple flagger flagging operations for a work zone that proceeds through an intersection with "stop sign controlled" side roads. Utilize Side Road Flaggers to control the traffic from the intersecting Side Roads unless otherwise directed by the District Engineering Administrator. Clear communications by radio or other effective methods between Side Road Flaggers, the Open Lane Flagger and the Closed Lane Flagger of the lane closure is required to ensure safe and efficient control of all traffic approaching the intersection. Maintain the Side Road Flaggers in place for the duration that any portion of the lane closure may encroach upon the Limits of the Intersection.
3. When the work zone proceeds through an intersection with a "stop sign controlled" side road, do not allow the Approach Taper or the Downstream Taper of the lane closure to encroach upon the Limits of the Intersection. Only the Buffer Space or the Work Activity Area of the lane closure may encroach upon the Limits of the Intersection.
4. When the work zone proceeds through a "stop sign controlled" intersection, continue the work operations through the intersection to a specific location point within the Departure Lane no less than 300 feet to 500 feet beyond the Limits of the Intersection to allow the work train and all portions of the lane closure to clear the intersection.

DRAWING 405-01-B(1)
 FLAGGING OPERATIONS
 MULTIPLE FLAGGERS
 TWO-LANE TWO-WAY ROADWAYS
 PRIMARY & SECONDARY
 ROUTES
 STOP SIGN CONTROLLED
 SIDE ROADS

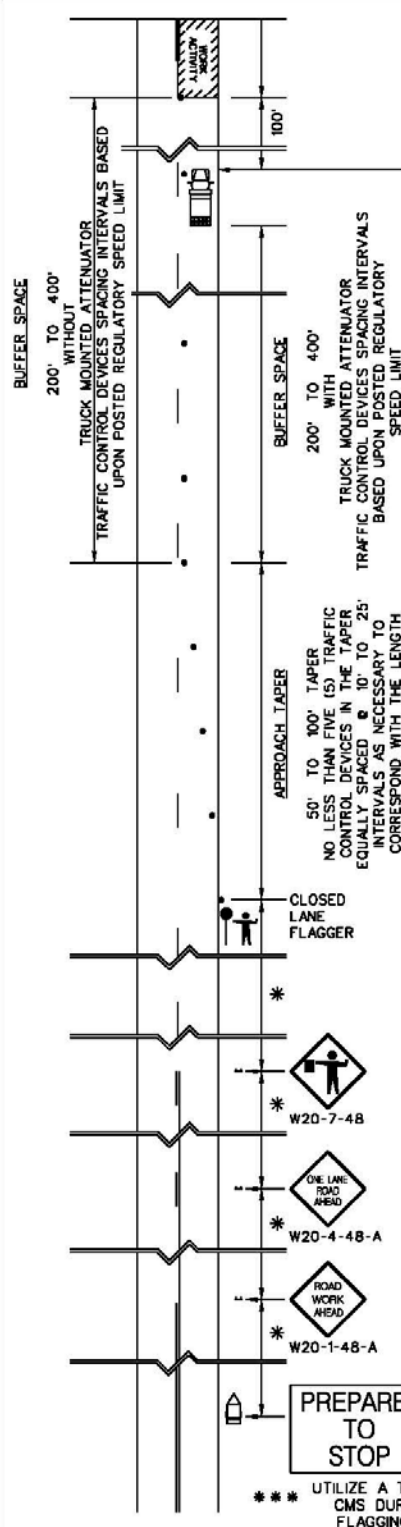

TRUCK MOUNTED ATTENUATOR (OPTIONAL)
 WHEN A TRUCK MOUNTED ATTENUATOR IS UTILIZED, OPERATE AS FOLLOWS:

THE TRUCK MOUNTED ATTENUATOR SHALL REMAIN APPROXIMATELY 100' IN ADVANCE OF THE WORK ACTIVITY (INCLUDING PERSONNEL AND MACHINERY) AT ALL TIMES.

AN ADVANCE WARNING ARROW PANEL IS OPTIONAL ON THIS VEHICLE. AN ADVANCE WARNING ARROW PANEL ON THIS VEHICLE SHALL OPERATE IN THE "FOUR CORNER" CAUTION MODE DISPLAYING FOUR LAMPS WITH ONE LAMP IN EACH CORNER.



Table A

TRAFFIC CONTROL DEVICE SPACING INTERVALS WORK ACTIVITY AREA	
SPEED LIMIT	SPACING INTERVALS
35 MPH OR LESS	25 FEET
40 MPH OR GREATER	50 FEET

Table B

SIGN PLACEMENT INTERVALS			
SPEED LIMIT	*	*	*
LOW SPEED 35 MPH OR LESS	200	200	200
INTERMEDIATE SPEED 40 - 50 MPH	350	350	350
HIGH SPEED 55 MPH OR GREATER	500	500	500

Table C

BUFFER SPACE DISTANCES	
SPEED LIMIT	DISTANCES
LOW SPEED 35 MPH OR LESS	200
INTERMEDIATE SPEED 40 - 50 MPH	300
HIGH SPEED 55 MPH OR GREATER	400

NOTE: ADJUSTMENTS TO THE BUFFER SPACE DISTANCES MAY BE REQUIRED DUE TO FIELD CONDITIONS.

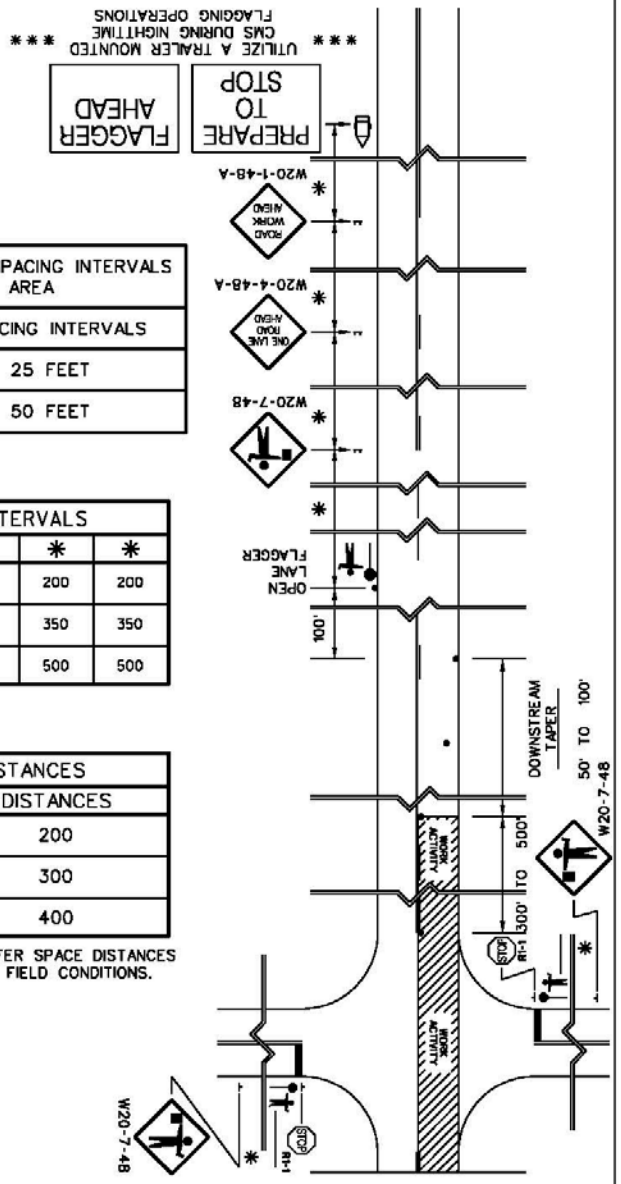

NIGHTTIME FLAGGING OPERATIONS
 ALL FLAGGERS SHALL WEAR CLASS 3 HIGH VISIBILITY SAFETY APPAREL MEETING ANS/ISEA 107 REQUIREMENTS.
 UTILIZE CHANGEABLE MESSAGE SIGNS ON EACH ROADWAY APPROACH DURING ALL PLANNED NIGHTTIME WORK ACTIVITIES THAT REQUIRE FLAGGING OPERATIONS.
 ILLUMINATE EACH FLAGGER STATION.
 UTILIZE PORTABLE PLASTIC DRUMS OR 42" OVERSIZED CONES INSTEAD OF STANDARD TRAFFIC CONES.

SPECIAL NOTE:
 DURING UNPLANNED NIGHTTIME EMERGENCY OPERATIONS, THE CHANGEABLE MESSAGE SIGNS MAY BE OMITTED, THE REQUIREMENT FOR THE CHANGEABLE MESSAGE SIGNS SHALL BE MAINTAINED FOR ALL PLANNED NIGHTTIME WORK ACTIVITIES THAT REQUIRE FLAGGING OPERATIONS.

**FLAGGING OPERATIONS
MULTIPLE FLAGGERS
TWO-LANE TWO-WAY ROADWAYS
PRIMARY & SECONDARY ROUTES
4-WAY STOP CONTROLLED
INTERSECTION**

1. See "Work Zone Traffic Control Procedures, Flagging Operations" for standard requirements regarding all flagging operations.
2. In accordance with this traffic control setup, install, maintain and conduct multiple flagger flagging operations for a work zone that proceeds through a "4-Way STOP controlled" intersection. Utilize Side Road Flaggers to control the traffic from the intersecting Side Roads unless otherwise directed by the District Engineering Administrator. Clear communications by radio or other effective methods between Side Road Flaggers, the Open Lane Flagger and the Closed Lane Flagger of the lane closure is required to ensure safe and efficient control of all traffic approaching the intersection. Maintain the Side Road Flaggers in place for the duration that any portion of the lane closure may encroach upon the Limits of the Intersection.
3. When the work zone proceeds through a "4-Way STOP controlled" intersection, do not allow the Approach Taper or the Downstream Taper of the lane closure to encroach upon the Limits of the Intersection. Only the Buffer Space or the Work Activity Area of the lane closure may encroach upon the Limits of the Intersection.
4. When the work zone proceeds through a "4-Way STOP controlled" intersection, continue the work operations through the intersection to a specific location point within the Departure Lane no less than 300 feet to 500 feet beyond the Limits of the Intersection to allow the work train and all portions of the lane closure to clear the intersection.

DRAWING 405-01-B(2)
 FLAGGING OPERATIONS
 MULTIPLE FLAGGERS
 TWO-LANE TWO-WAY ROADWAYS
 PRIMARY & SECONDARY
 ROUTES
 4-WAY STOP CONTROLLED
 INTERSECTION

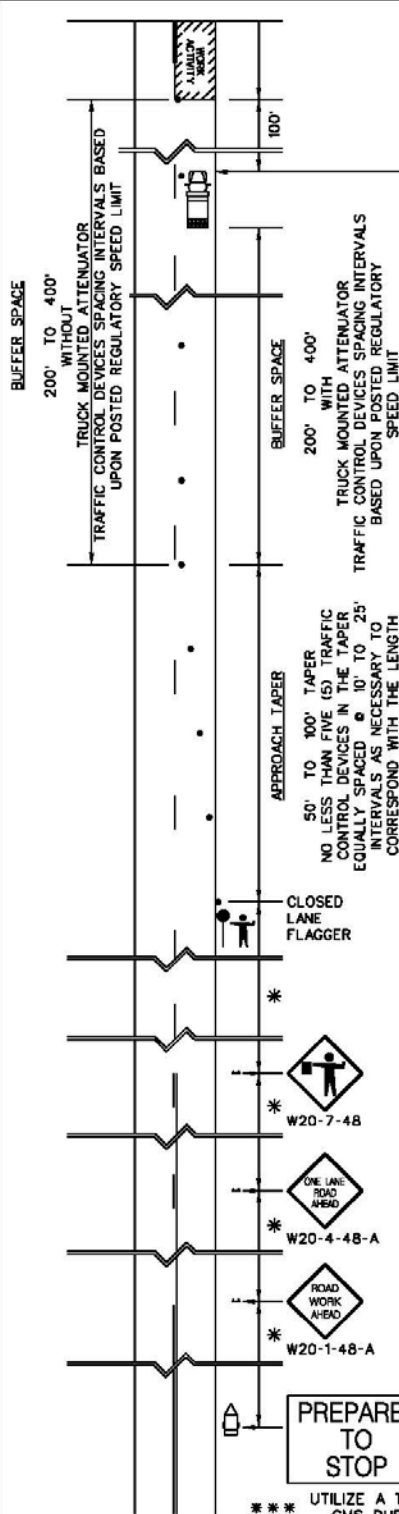

TRUCK MOUNTED ATTENUATOR (OPTIONAL)

WHEN A TRUCK MOUNTED ATTENUATOR IS UTILIZED, OPERATE AS FOLLOWS:

THE TRUCK MOUNTED ATTENUATOR SHALL REMAIN APPROXIMATELY 100' IN ADVANCE OF THE WORK ACTIVITY (INCLUDING PERSONNEL AND MACHINERY) AT ALL TIMES.

AN ADVANCE WARNING ARROW PANEL IS OPTIONAL ON THIS VEHICLE. AN ADVANCE WARNING ARROW PANEL ON THIS VEHICLE SHALL OPERATE IN THE "FOUR CORNER" CAUTION MODE DISPLAYING FOUR LAMPS WITH ONE LAMP IN EACH CORNER.

Table A

TRAFFIC CONTROL DEVICE SPACING INTERVALS WORK ACTIVITY AREA	
SPEED LIMIT	SPACING INTERVALS
35 MPH OR LESS	25 FEET
40 MPH OR GREATER	50 FEET

Table B

SIGN PLACEMENT INTERVALS			
SPEED LIMIT	*	*	*
LOW SPEED 35 MPH OR LESS	200	200	200
INTERMEDIATE SPEED 40 - 50 MPH	350	350	350
HIGH SPEED 55 MPH OR GREATER	500	500	500

Table C

BUFFER SPACE DISTANCES	
SPEED LIMIT	DISTANCES
LOW SPEED 35 MPH OR LESS	200
INTERMEDIATE SPEED 40 - 50 MPH	300
HIGH SPEED 55 MPH OR GREATER	400

NOTE: ADJUSTMENTS TO THE BUFFER SPACE DISTANCES MAY BE REQUIRED DUE TO FIELD CONDITIONS.

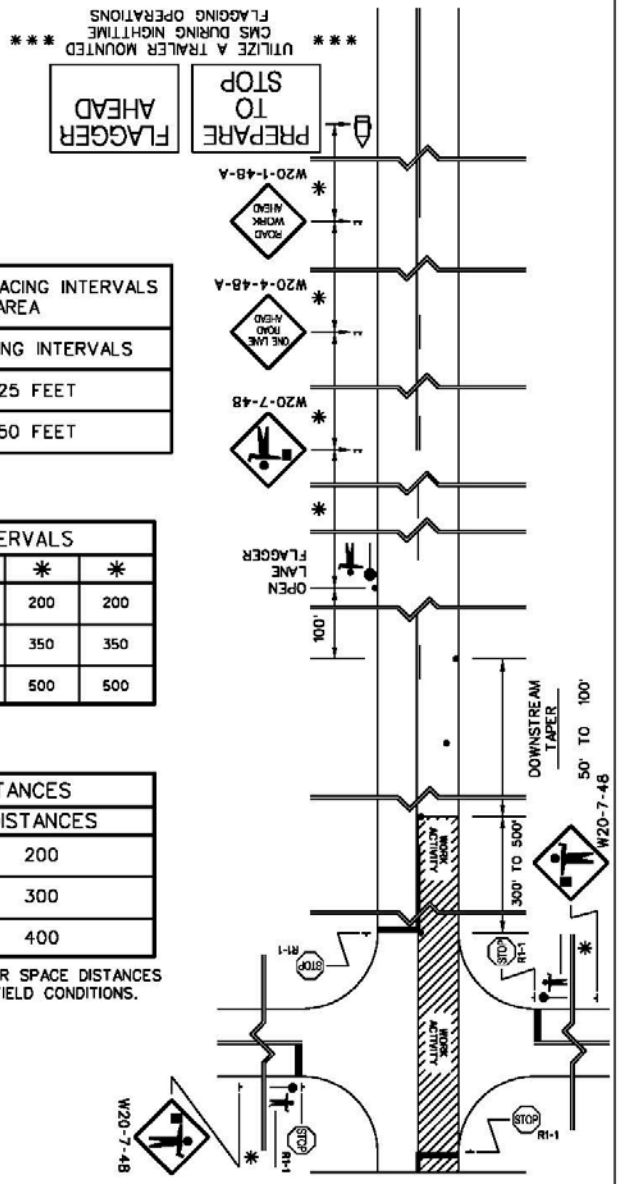

NIGHTTIME FLAGGING OPERATIONS

ALL FLAGGERS SHALL WEAR CLASS 3 HIGH VISIBILITY SAFETY APPAREL MEETING ANSI/ISEA 107 REQUIREMENTS.

UTILIZE CHANGEABLE MESSAGE SIGNS ON EACH ROADWAY APPROACH DURING ALL PLANNED NIGHTTIME WORK ACTIVITIES THAT REQUIRE FLAGGING OPERATIONS.

ILLUMINATE EACH FLAGGER STATION.

UTILIZE PORTABLE PLASTIC DRUMS OR 42" OVERSIZED CONES INSTEAD OF STANDARD TRAFFIC CONES.

SPECIAL NOTE:

DURING UNPLANNED NIGHTTIME EMERGENCY OPERATIONS, THE CHANGEABLE MESSAGE SIGNS MAY BE OMITTED. THE REQUIREMENT FOR THE CHANGEABLE MESSAGE SIGNS SHALL BE MAINTAINED FOR ALL PLANNED NIGHTTIME WORK ACTIVITIES THAT REQUIRE FLAGGING OPERATIONS.

**FLAGGING OPERATIONS
MULTIPLE FLAGGERS
TWO-LANE TWO-WAY ROADWAYS
PRIMARY & SECONDARY ROUTES
TRAFFIC SIGNAL CONTROLLED
INTERSECTION
LAW ENFORCEMENT OFFICER(S)**

1. See "Work Zone Traffic Control Procedures, Flagging Operations" for standard requirements regarding all flagging operations.
2. In accordance with this traffic control setup, when the work zone proceeds through or encroaches upon the Limits of the Intersection of a "traffic signal controlled" intersection, engage a uniformed law enforcement officer(s) to control and direct all traffic entering and passing through the intersection. When a uniformed law enforcement officer is present to control the traffic entering and passing through the intersection, the traffic signal may or may not be placed on "normal flashing operations". Clear communications by radio or other effective method between the law enforcement officer(s) and the Open Lane Flagger and the Closed Lane Flagger of the lane closure is recommended to ensure safe and efficient control of all traffic approaching the intersection. Upon clearance of the Limits of the Intersection by the work train that will permit the location of the subsequent Flagger Station be no less than 200 feet past the Limits of the Intersection, ensure the traffic signal is returned to normal operational status and is operating in accordance with all operational functions prior to initiation of the "normal flashing operations".
3. When the work zone proceeds through a "traffic signal controlled" intersection, do not allow the Approach Taper or the Downstream Taper of the lane closure to encroach upon the Limits of the Intersection. Only the Buffer Space or the Work Activity Area of the lane closure may encroach upon the Limits of the Intersection.
4. When the work zone proceeds through a "traffic signal controlled" intersection, continue the work operations through the intersection to a specific location point within the Departure Lane no less than 300 feet to 500 feet beyond the Limits of the Intersection to allow the work train and all portions of the lane closure to clear the intersection.

DRAWING 405-01-C(1)
 FLAGGING OPERATIONS
 MULTIPLE FLAGGERS
 TWO-LANE TWO-WAY ROADWAYS
 PRIMARY & SECONDARY
 ROUTES
 TRAFFIC SIGNAL CONTROLLED
 INTERSECTION
 LAW ENFORCEMENT OFFICER(S)

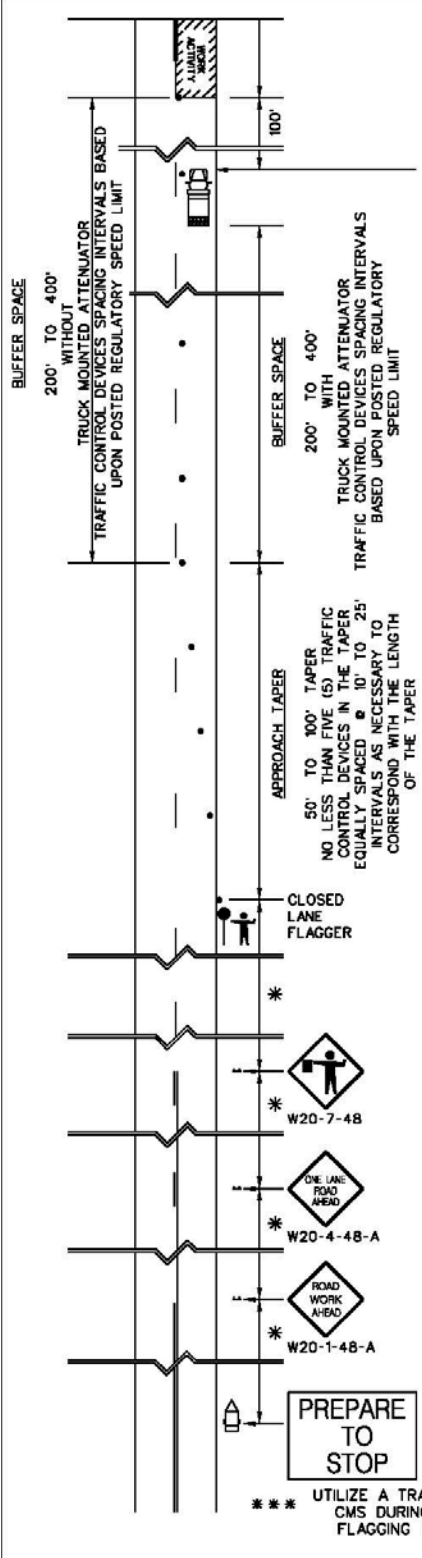

TRUCK MOUNTED ATTENUATOR (OPTIONAL)

WHEN A TRUCK MOUNTED ATTENUATOR IS UTILIZED, OPERATE AS FOLLOWS:

THE TRUCK MOUNTED ATTENUATOR SHALL REMAIN APPROXIMATELY 100' IN ADVANCE OF THE WORK ACTIVITY (INCLUDING PERSONNEL AND MACHINERY) AT ALL TIMES.

AN ADVANCE WARNING ARROW PANEL IS OPTIONAL ON THIS VEHICLE. AN ADVANCE WARNING ARROW PANEL ON THIS VEHICLE SHALL OPERATE IN THE "FOUR CORNER" CAUTION MODE DISPLAYING FOUR LAMPS WITH ONE LAMP IN EACH CORNER.

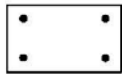

Table A

TRAFFIC CONTROL DEVICE SPACING INTERVALS WORK ACTIVITY AREA	
SPEED LIMIT	SPACING INTERVALS
35 MPH OR LESS	25 FEET
40 MPH OR GREATER	50 FEET

Table B

SIGN PLACEMENT INTERVALS			
SPEED LIMIT	*	*	*
LOW SPEED 35 MPH OR LESS	200	200	200
INTERMEDIATE SPEED 40 - 50 MPH	350	350	350
HIGH SPEED 55 MPH OR GREATER	500	500	500

Table C

BUFFER SPACE DISTANCES	
SPEED LIMIT	DISTANCES
LOW SPEED 35 MPH OR LESS	200
INTERMEDIATE SPEED 40 - 50 MPH	300
HIGH SPEED 55 MPH OR GREATER	400

NOTE: ADJUSTMENTS TO THE BUFFER SPACE DISTANCES MAY BE REQUIRED DUE TO FIELD CONDITIONS.

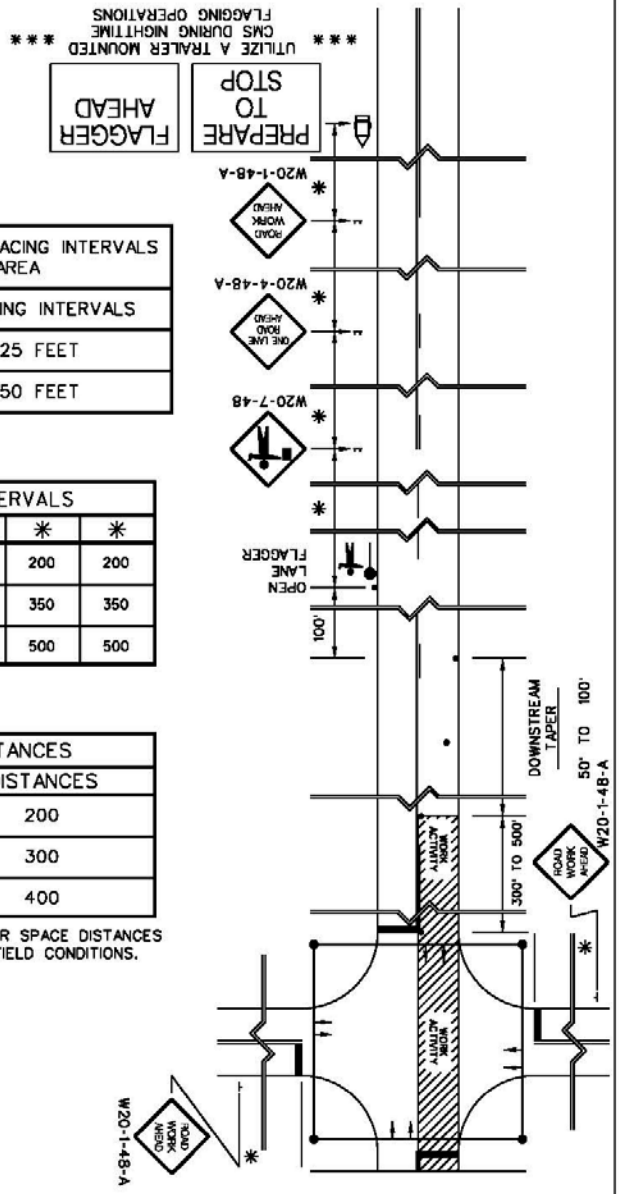

NIGHTTIME FLAGGING OPERATIONS

ALL FLAGGERS SHALL WEAR CLASS 3 HIGH VISIBILITY SAFETY APPAREL MEETING ANSI/ISEA 107 REQUIREMENTS.

UTILIZE CHANGEABLE MESSAGE SIGNS ON EACH ROADWAY APPROACH DURING ALL PLANNED NIGHTTIME WORK ACTIVITIES THAT REQUIRE FLAGGING OPERATIONS.

ILLUMINATE EACH FLAGGER STATION.

UTILIZE PORTABLE PLASTIC DRUMS OR 42" OVERSIZED CONES INSTEAD OF STANDARD TRAFFIC CONES.

SPECIAL NOTE:

DURING UNPLANNED NIGHTTIME EMERGENCY OPERATIONS, THE CHANGEABLE MESSAGE SIGNS MAY BE OMITTED. THE REQUIREMENT FOR THE CHANGEABLE MESSAGE SIGNS SHALL BE MAINTAINED FOR ALL PLANNED NIGHTTIME WORK ACTIVITIES THAT REQUIRE FLAGGING OPERATIONS.

**FLAGGING OPERATIONS
MULTIPLE FLAGGERS
TWO-LANE TWO-WAY ROADWAYS
PRIMARY & SECONDARY ROUTES
TRAFFIC SIGNAL CONTROLLED
INTERSECTION
FLAGGERS**

1. See "Work Zone Traffic Control Procedures, Flagging Operations" for standard requirements regarding all flagging operations.
2. In accordance with this traffic control setup, when the work zone proceeds through or encroaches upon the Limits of the Intersection of a "traffic signal controlled" intersection, place the traffic signal on "normal flashing operations". Utilize Side Road Flaggers on the Side Road approaches of the intersection to control the traffic from the Side Roads. Clear communications by radio or other effective method between the Side Road Flaggers and the Open Lane Flagger and the Closed Lane Flagger of the lane closure is required to ensure safe and efficient control of all traffic approaching the intersection. Upon clearance of the Limits of the Intersection by the work train and all portions of the lane closure, ensure the traffic signal is returned to normal operational status and is operating in accordance with all operational functions prior to initiation of the "normal flashing operations".
3. When the work zone proceeds through a "traffic signal controlled" intersection, do not allow the Approach Taper or the Downstream Taper of the lane closure to encroach upon the limits of the intersection. Only the Buffer Space or the Work Activity Area of the lane closure may encroach upon the Limits of the Intersection.
4. When the work zone proceeds through a "traffic signal controlled" intersection, continue the work operations through the intersection to a specific location point within the Departure Lane no less than 300 feet to 500 feet beyond the Limits of the Intersection to allow the work train and all portions of the lane closure to clear the intersection.

DRAWING 405-01-C(2)
 FLAGGING OPERATIONS
 MULTIPLE FLAGGERS
 TWO-LANE TWO-WAY ROADWAYS
 PRIMARY & SECONDARY
 ROUTES
 TRAFFIC SIGNAL CONTROLLED
 INTERSECTION
 FLAGGERS

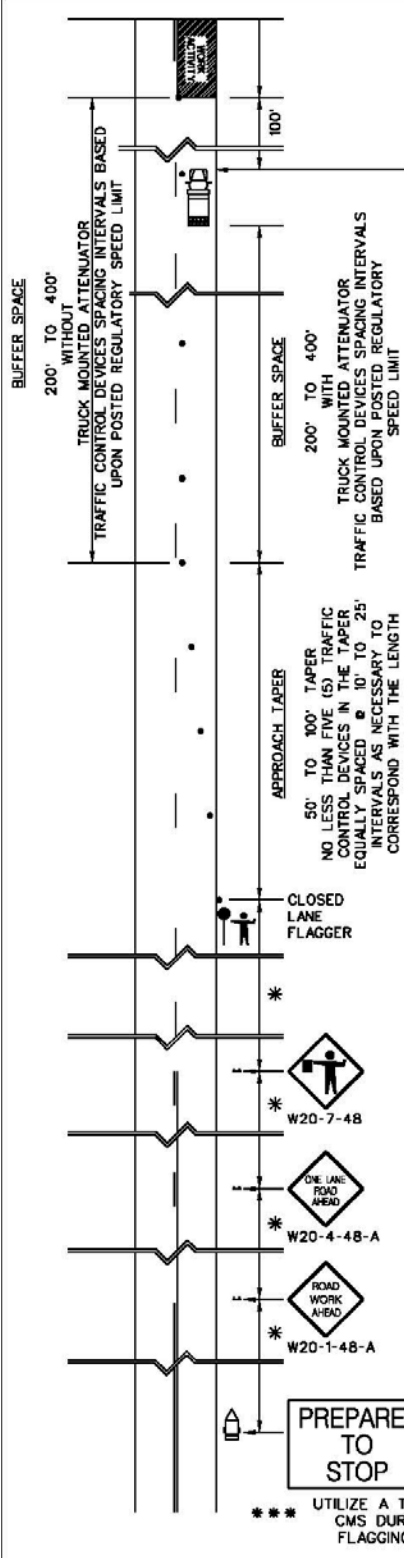

TRUCK MOUNTED ATTENUATOR (OPTIONAL)

WHEN A TRUCK MOUNTED ATTENUATOR IS UTILIZED, OPERATE AS FOLLOWS:

THE TRUCK MOUNTED ATTENUATOR SHALL REMAIN APPROXIMATELY 100' IN ADVANCE OF THE WORK ACTIVITY (INCLUDING PERSONNEL AND MACHINERY) AT ALL TIMES.

AN ADVANCE WARNING ARROW PANEL IS OPTIONAL ON THIS VEHICLE. AN ADVANCE WARNING ARROW PANEL ON THIS VEHICLE SHALL OPERATE IN THE "FOUR CORNER" CAUTION MODE DISPLAYING FOUR LAMPS WITH ONE LAMP IN EACH CORNER.

Table A

TRAFFIC CONTROL DEVICE SPACING INTERVALS WORK ACTIVITY AREA	
SPEED LIMIT	SPACING INTERVALS
35 MPH OR LESS	25 FEET
40 MPH OR GREATER	50 FEET

Table B

SIGN PLACEMENT INTERVALS			
SPEED LIMIT	*	*	*
LOW SPEED 35 MPH OR LESS	200	200	200
INTERMEDIATE SPEED 40 - 50 MPH	350	350	350
HIGH SPEED 55 MPH OR GREATER	500	500	500

Table C

BUFFER SPACE DISTANCES	
SPEED LIMIT	DISTANCES
LOW SPEED 35 MPH OR LESS	200
INTERMEDIATE SPEED 40 - 50 MPH	300
HIGH SPEED 55 MPH OR GREATER	400

NOTE: ADJUSTMENTS TO THE BUFFER SPACE DISTANCES MAY BE REQUIRED DUE TO FIELD CONDITIONS.

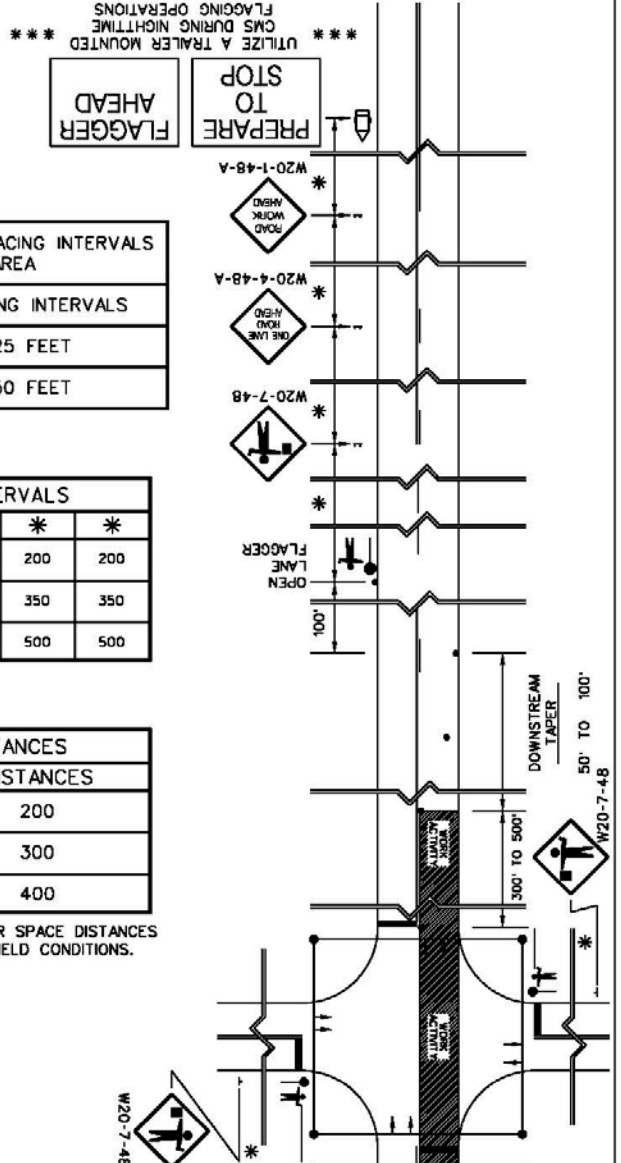

NIGHTTIME FLAGGING OPERATIONS

ALL FLAGGERS SHALL WEAR CLASS 3 HIGH VISIBILITY SAFETY APPAREL MEETING ANSI/ISEA 107 REQUIREMENTS.

UTILIZE CHANGEABLE MESSAGE SIGNS ON EACH ROADWAY APPROACH DURING ALL PLANNED NIGHTTIME WORK ACTIVITIES THAT REQUIRE FLAGGING OPERATIONS.

ILLUMINATE EACH FLAGGER STATION.

UTILIZE PORTABLE PLASTIC DRUMS OR 42" OVERSIZED CONES INSTEAD OF STANDARD TRAFFIC CONES.

SPECIAL NOTE:

DURING UNPLANNED NIGHTTIME EMERGENCY OPERATIONS, THE CHANGEABLE MESSAGE SIGNS MAY BE OMITTED. THE REQUIREMENT FOR THE CHANGEABLE MESSAGE SIGNS SHALL BE MAINTAINED FOR ALL PLANNED NIGHTTIME WORK ACTIVITIES THAT REQUIRE FLAGGING OPERATIONS.

Drawing No. 405-01-D(1)

**FLAGGING OPERATIONS
MULTIPLE FLAGGERS
TWO-LANE TWO-WAY ROADWAYS
PRIMARY & SECONDARY ROUTES
WORK ACTIVITY AREA
BEGINNING at an
INTERSECTION with a
TWO-LANE TWO-WAY ROADWAY
DEPARTURE LANE**

1. See "Work Zone Traffic Control Procedures, Flagging Operations" for standard requirements regarding all flagging operations.
2. Install, maintain and conduct multiple flagger flagging operations for a work zone that begins at an intersection and is present within the travel lane of a two-lane two-way roadway departing from the intersection as illustrated by this standard drawing. Install and maintain all advance warning signs and traffic control devices as illustrated.
3. Convert this traffic control setup to a standard multiple flagger operation in compliance with Drawing No. 405-01-A for a Work Activity Area located in the Departure Lane when the Limits of the Work Activity Area nearest the intersection progress beyond a minimum distance interval away from the intersection as specified in Table 12*. The Limits of the Work Activity Area nearest to the adjacent intersection must be located at a specific location point no less than the cumulative distance from the intersection as specified by the "Total Distance Required for Conversion" in Table 12*.

* Table 12 – "Departure Lane from the Intersection Minimum Distance Intervals from Intersection Required for Conversion to Standard Multiple Flagger Flagging Operation Installation per Drawing No. 405-01-D(1)."

** The distance figures specified in the "Total Distance Required for Conversion" are calculated based upon the posted regulatory speed limit of the road prior to beginning the work.

Table 12 *Departure Lane from the Intersection
Minimum Distance Intervals from Intersection Required for Conversion to Standard
Multiple Flagger Flagger Operation Installation per Drawing No. 405-01-D(1)*

	Low Speed 35 MPH or Less	Intermediate Speed 40 - 50 MPH	High Speed 55 MPH or Greater
DAYTIME	Space for Stopped Traffic to Queue (100 feet Minimum)	Space for Stopped Traffic to Queue (100 feet Minimum)	Space for Stopped Traffic to Queue (100 feet Minimum)
	Advance Warning Sign Placement Intervals (Interval / Total) (200 feet / 600 feet)	Advance Warning Sign Placement Intervals (Interval / Total) (350 feet / 1050 feet)	Advance Warning Sign Placement Intervals (Interval / Total) (500 feet / 1500 feet)
	Approach Taper (100 feet)	Approach Taper (100 feet)	Approach Taper (100 feet)
	Buffer Space (200 feet)	Buffer Space (300 feet)	Buffer Space (400 feet)
	Total Distance Required for Conversion 1000 feet	Total Distance Required for Conversion 1550 feet	Total Distance Required for Conversion 2100 feet
	NIGHTTIME	Changeable Message Sign Placement Interval 200 feet	Changeable Message Sign Placement Interval 350 feet
Total Distance Required for Conversion 1200 feet		Total Distance Required for Conversion 1900 feet	Total Distance Required for Conversion 2600 feet

Notes: The distance intervals required for a truck mounted attenuator, including the length of the vehicle and the associated 100-foot roll-ahead distance, is not included in these calculations since this device is optional. However, when truck mounted attenuator is utilized, add an additional 125 feet to the total distance required for conversion to compensate for the 100-foot roll-ahead distance and the approximate length of the vehicle and the attenuator.

The total distances for nighttime operations are increased due to the requirement for inclusion of a trailer mounted changeable message sign.

4. Sufficient Buffer Space may be unavailable when conducting work activities contiguous to the intersection. Install the Buffer Space immediately as the Limits of the Work Activity Area nearest the intersection move away from the intersection. As sufficient space becomes available, install and maintain the required Buffer Space based upon the legal posted regulatory speed limit of the roadway.

5. On each roadway approach intersecting the roadway where the work activities are being conducted, install multiple flagger flagging operations to control all traffic approaching the intersection from those roads. Station the flaggers controlling traffic from these roads immediately adjacent to the intersection as illustrated. No less than one (1) flagger is required on each approach to control traffic flow.

On the roadway where the work is being conducted, station the Open Lane Flagger controlling traffic approaching the Work Activity Area and the intersection, 100 feet beyond the last traffic control device in the downstream taper furthest away from the work activity area as illustrated.

6. On each roadway approach intersecting the roadway where the work activities are being conducted, measure the advance warning sign locations from each flagger station at the intersection.

On the roadway where the work is being conducted, measure the advance warning sign locations from the Open Lane Flagger station located 100 feet beyond the last traffic control device in the downstream taper.

7. When conducting nighttime flagging operations in accordance with this standard drawing, supplement each advance sign array on each approach to the intersection with a trailer mounted changeable message sign. The messages should be "PREPARE TO STOP", "FLAGGER AHEAD." During a nighttime flagging operation scenario where the Work Activity Area begins at an intersection as illustrated by this standard drawing, utilization of a trailer mounted changeable message sign to supplement each array of advance warning signs on each leg of the intersection are required. Install, operate and maintain these trailer mounted changeable message signs as illustrated.

DRAWING 405-01-D(1)
 FLAGGING OPERATIONS
 MULTIPLE FLAGGERS
 TWO-LANE TWO-WAY ROADWAYS
 PRIMARY & SECONDARY ROUTES
 WORK ACTIVITY AREA
 BEGINNING at an
 INTERSECTION with a
 TWO-LANE TWO-WAY ROADWAY
 DEPARTURE LANE

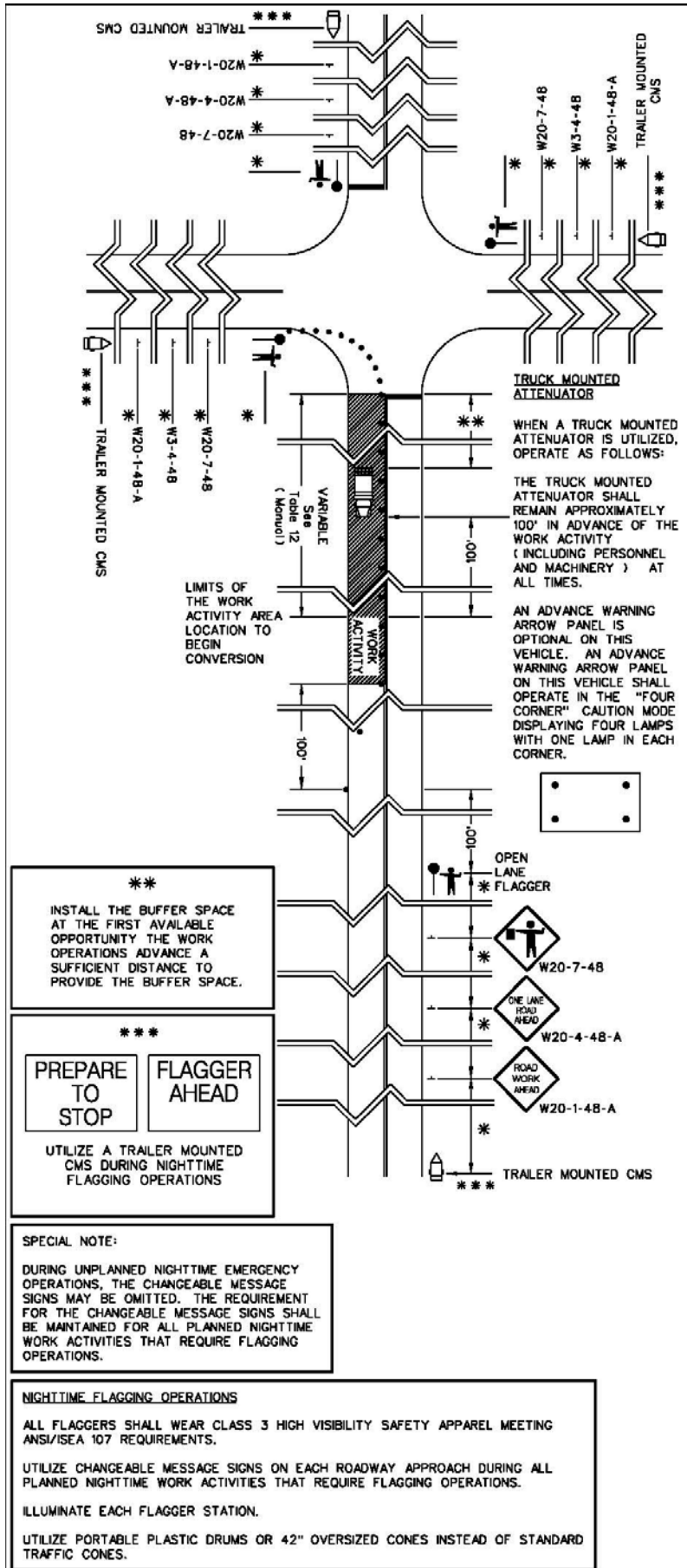

GENERAL NOTES:

1. THIS TRAFFIC CONTROL SETUP ILLUSTRATES AND SPECIFIES THE TRAFFIC CONTROL REQUIREMENTS FOR CONDUCTING FLAGGING OPERATIONS FOR A WORK ZONE THAT BEGINS AT AN INTERSECTION AND IS PRESENT WITHIN THE TRAVEL LANE OF A TWO-LANE TWO-WAY ROADWAY DEPARTING FROM THE INTERSECTION. INSTALL AND MAINTAIN THIS TRAFFIC CONTROL SETUP WHEN THE LIMITS OF THE WORK ACTIVITY AREA NEAREST TO THE INTERSECTION ARE LOCATED AT A POINT FROM THE INTERSECTION LESS THAN OR EQUAL TO THE TOTAL DISTANCE INTERVAL REQUIRED FOR CONVERSION TO A STANDARD MULTIPLE FLAGGER FLAGGING OPERATION AS SPECIFIED IN THE MANUAL. WHEN CONVERTING THIS TRAFFIC CONTROL SETUP TO A STANDARD MULTIPLE FLAGGER FLAGGING OPERATION, INSTALL ALL ADVANCE WARNING SIGNS, TRAFFIC CONTROL DEVICES, THE TAPER AREA, THE FLAGGER STATION AND THE BUFFER SPACE AS REQUIRED AND AS DIRECTED BY DRAWING 405-01-A UNLESS OTHERWISE DIRECTED BY THE ENGINEER.
2. INSTALL AND CONDUCT FLAGGING OPERATIONS ON ALL APPROACHES TO THE INTERSECTION. ONLY FLAGGERS AND ADVANCE WARNING SIGNS, INCLUDING CHANGEABLE MESSAGE SIGNS DURING NIGHTTIME FLAGGING OPERATIONS, ARE REQUIRED ON THE ROADWAY APPROACHES INTERSECTING THE ROADWAY WHERE THE WORK ACTIVITIES ARE BEING CONDUCTED. TRAFFIC CONTROL DEVICES FOR DELINEATION AND CHANNELIZATION ARE NOT REQUIRED ON THE INTERSECTING ROADWAY APPROACHES UNLESS OTHERWISE DIRECTED BY THE ENGINEER.
3. MAINTAIN TWO-WAY RADIO COMMUNICATIONS BETWEEN ALL FLAGGERS.

Table A

TRAFFIC CONTROL DEVICE SPACING INTERVALS WORK ACTIVITY AREA	
SPEED LIMIT	SPACING INTERVALS
35 MPH OR LESS	25 FEET
40 MPH OR GREATER	50 FEET

Table B

SIGN PLACEMENT INTERVALS			
SPEED LIMIT	*	*	*
LOW SPEED 35 MPH OR LESS	200	200	200
INTERMEDIATE SPEED 40 - 50 MPH	350	350	350
HIGH SPEED 55 MPH OR GREATER	500	500	500

NOTE: THESE SIGN PLACEMENT INTERVALS ARE BASED UPON THE POSTED REGULATORY SPEED LIMIT OF THE ROADWAY PRIOR TO BEGINNING ANY WORK.

Table C

BUFFER SPACE DISTANCES	
SPEED LIMIT	DISTANCES
LOW SPEED 35 MPH OR LESS	200
INTERMEDIATE SPEED 40 - 50 MPH	300
HIGH SPEED 55 MPH OR GREATER	400

NOTE: ADJUSTMENTS TO THE BUFFER SPACE DISTANCES MAY BE REQUIRED DUE TO FIELD CONDITIONS.

INSTALL THE BUFFER SPACE AT THE FIRST AVAILABLE OPPORTUNITY THE WORK OPERATIONS ADVANCE A SUFFICIENT DISTANCE TO PROVIDE THE BUFFER SPACE.

PREPARE TO STOP FLAGGER AHEAD

UTILIZE A TRAILER MOUNTED CMS DURING NIGHTTIME FLAGGING OPERATIONS

SPECIAL NOTE:
 DURING UNPLANNED NIGHTTIME EMERGENCY OPERATIONS, THE CHANGEABLE MESSAGE SIGNS MAY BE OMITTED. THE REQUIREMENT FOR THE CHANGEABLE MESSAGE SIGNS SHALL BE MAINTAINED FOR ALL PLANNED NIGHTTIME WORK ACTIVITIES THAT REQUIRE FLAGGING OPERATIONS.

NIGHTTIME FLAGGING OPERATIONS
 ALL FLAGGERS SHALL WEAR CLASS 3 HIGH VISIBILITY SAFETY APPAREL MEETING ANSI/ISEA 107 REQUIREMENTS.
 UTILIZE CHANGEABLE MESSAGE SIGNS ON EACH ROADWAY APPROACH DURING ALL PLANNED NIGHTTIME WORK ACTIVITIES THAT REQUIRE FLAGGING OPERATIONS.
 ILLUMINATE EACH FLAGGER STATION.
 UTILIZE PORTABLE PLASTIC DRUMS OR 42" OVERSIZED CONES INSTEAD OF STANDARD TRAFFIC CONES.

Drawing No. 405-01-D(2)

**FLAGGING OPERATIONS
MULTIPLE FLAGGERS
TWO-LANE TWO-WAY ROADWAYS
PRIMARY & SECONDARY ROUTES
WORK ACTIVITY AREA
TERMINATING at an
INTERSECTION with a
TWO-LANE TWO-WAY ROADWAY
APPROACH LANE**

1. See "Work Zone Traffic Control Procedures, Flagging Operations" for standard requirements regarding all flagging operations.
2. Install, maintain and conduct multiple flagger flagging operations for a work zone that ends at an intersection and is present within the travel lane of a two-lane two-way roadway approaching the intersection as illustrated by this standard drawing. Install and maintain all advance warning signs and traffic control devices as illustrated.
3. Convert a standard multiple flagger operation installed per Drawing No. 405-01-A for a Work Activity Area located in the Approach Lane of a two-lane two-way road when the Limits of the Work Activity Area nearest the intersection encroach upon a specific location that will not permit the required distances for the traffic to queue, proper installation of the advance warning signs, the Open Lane Flagger station and the Downstream Taper. The minimum distances that determine when conversion to this traffic control setup is required are found in *Table 13**. The Limits of the Work Activity Area nearest the intersection should not encroach upon a specific location point no less than the cumulative distance from the intersection as specified by the "Total Distance Required for Conversion"*** in *Table 13*.

* *Table 13 – "Approach Lane to the Intersection Minimum Distance Intervals from Intersection Required for Conversion from a Standard Multiple Flagger Flagging Operation Installation per Drawing No. 405-01-D(2)."*

** *The distance figures specified in the "Total Distance Required for Conversion" are calculated based upon the posted regulatory speed limit of the road prior to beginning the work.*

**Table 13 Approach Lane to the Intersection
Minimum Distance Intervals from Intersection Required for Conversion from a Standard
Multiple Flagger Flagging Operation Installation per Drawing No. 405-01-D(2)**

	Low Speed 35 MPH or Less	Intermediate Speed 40 - 50 MPH	High Speed 55 MPH or Greater
DAYTIME	Space for Stopped Traffic to Queue (100 feet Minimum)	Space for Stopped Traffic to Queue (100 feet Minimum)	Space for Stopped Traffic to Queue (100 feet Minimum)
	Advance Warning Sign Placement Intervals (Interval / Total) (200 feet / 600 feet)	Advance Warning Sign Placement Intervals (Interval / Total) (350 feet / 1050 feet)	Advance Warning Sign Placement Intervals (Interval / Total) (500 feet / 1500 feet)
	Downstream Taper (100 feet)	Downstream Taper (100 feet)	Downstream Taper (100 feet)
	Interval Between End of Downstream Taper And Open Lane Flagger (100 feet)	Interval Between End of Downstream Taper And Open Lane Flagger (100 feet)	Interval Between End of Downstream Taper And Open Lane Flagger (100 feet)
	Total Distance Required for Conversion 900 feet	Total Distance Required for Conversion 1350 feet	Total Distance Required for Conversion 1800 feet
	NIGHTTIME	Changeable Message Sign Placement Interval 200 feet	Changeable Message Sign Placement Interval 350 feet
Total Distance Required for Conversion 1100 feet		Total Distance Required for Conversion 1700 feet	Total Distance Required for Conversion 2300 feet

Notes: The distance intervals required for a downstream taper vary from 50 feet to 100 feet. The maximum distance of 100 feet is utilized for these scenarios.
The total distances for nighttime operations are increased due to the requirement for inclusion of a trailer mounted changeable message sign.

5. On each roadway approach intersecting the roadway where the work activities are being conducted, install multiple flagger flagging operations to control all traffic approaching the intersection from those roads. Station the flaggers controlling traffic from these roads immediately adjacent to the intersection as illustrated. No less than one (1) flagger is required on each approach to control traffic flow.

On the roadway where the work is being conducted, station the Closed Lane Flagger controlling traffic approaching the Work Activity Area and the intersection, adjacent to the first traffic control device in the approach taper as illustrated.

6. On each roadway approach intersecting the roadway where the work activities are being conducted, measure the advance warning sign locations from each flagger station at the intersection.

On the roadway where the work is being conducted, measure the advance warning sign locations from the Closed Lane Flagger station located 100 feet beyond the last traffic control device in the downstream taper.

7. When conducting nighttime flagging operations in accordance with this standard drawing, supplement each advance sign array on each approach to the intersection with a trailer mounted changeable message sign. The messages should be "PREPARE TO STOP", "FLAGGER AHEAD." During a nighttime flagging operation scenario where the Work Activity Area ends at an intersection as illustrated by this standard drawing, utilization of a trailer mounted changeable message sign to supplement each array of advance warning signs on each leg of the intersection are required. Install, operate and maintain these trailer mounted changeable message signs as illustrated.

DRAWING 405-01-D(2)
 FLAGGING OPERATIONS
 MULTIPLE FLAGGERS
 TWO-LANE TWO-WAY ROADWAYS
 PRIMARY & SECONDARY ROUTES
 WORK ACTIVITY AREA
 TERMINATING at an
 INTERSECTION with a
 TWO-LANE TWO-WAY ROADWAY
 APPROACH LANE

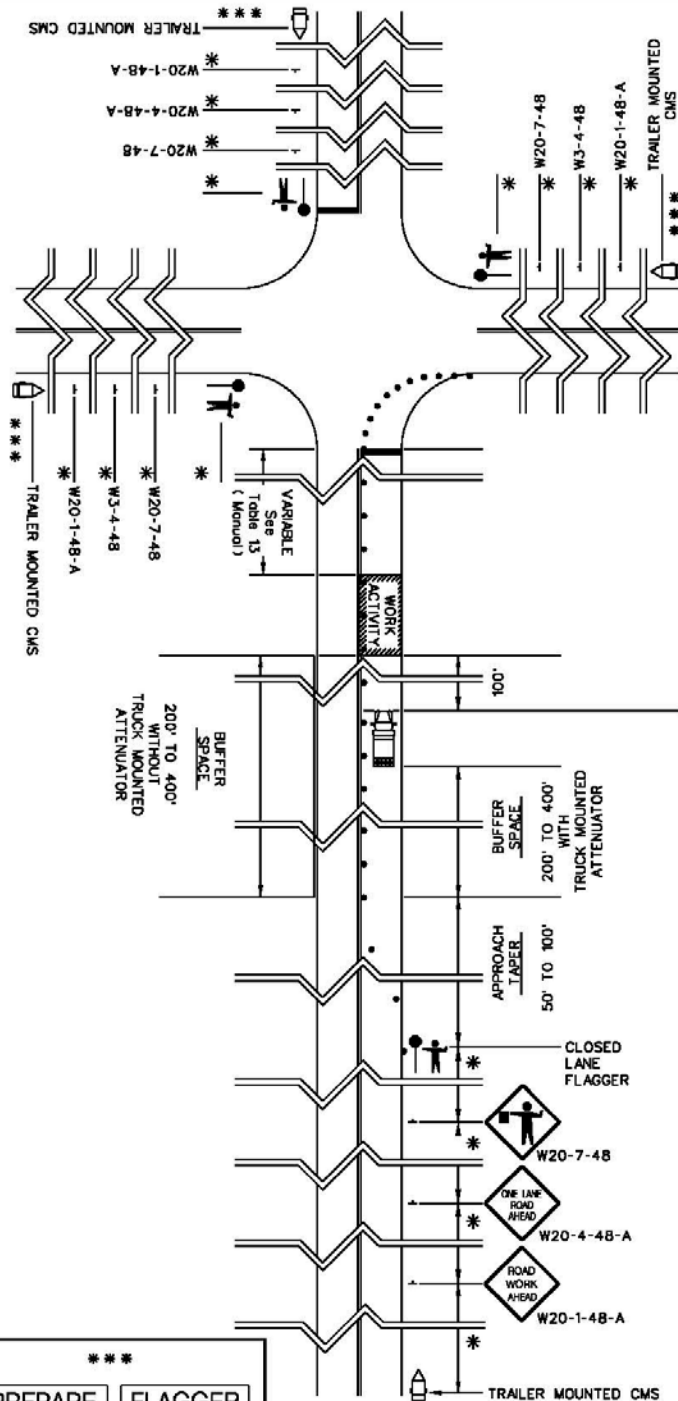

TRUCK MOUNTED ATTENUATOR (OPTIONAL)

WHEN A TRUCK MOUNTED ATTENUATOR IS UTILIZED, OPERATE AS FOLLOWS:

THE TRUCK MOUNTED ATTENUATOR SHALL REMAIN APPROXIMATELY 100' IN ADVANCE OF THE WORK ACTIVITY (INCLUDING PERSONNEL AND MACHINERY) AT ALL TIMES.

AN ADVANCE WARNING ARROW PANEL IS OPTIONAL ON THIS VEHICLE. AN ADVANCE WARNING ARROW PANEL ON THIS VEHICLE SHALL OPERATE IN THE "FOUR CORNER" CAUTION MODE DISPLAYING FOUR LAMPS WITH ONE LAMP IN EACH CORNER.

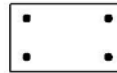

SPECIAL NOTE:

DURING UNPLANNED NIGHTTIME EMERGENCY OPERATIONS, THE CHANGEABLE MESSAGE SIGNS MAY BE OMITTED. THE REQUIREMENT FOR THE CHANGEABLE MESSAGE SIGNS SHALL BE MAINTAINED FOR ALL PLANNED NIGHTTIME WORK ACTIVITIES THAT REQUIRE FLAGGING OPERATIONS.

PREPARE TO STOP **FLAGGER AHEAD**

UTILIZE A TRAILER MOUNTED CMS DURING NIGHTTIME FLAGGING OPERATIONS

NIGHTTIME FLAGGING OPERATIONS

ALL FLAGGERS SHALL WEAR CLASS 3 HIGH VISIBILITY SAFETY APPAREL MEETING ANSI/ISEA 107 REQUIREMENTS.

UTILIZE CHANGEABLE MESSAGE SIGNS ON EACH ROADWAY APPROACH DURING ALL PLANNED NIGHTTIME WORK ACTIVITIES THAT REQUIRE FLAGGING OPERATIONS.

ILLUMINATE EACH FLAGGER STATION.

UTILIZE PORTABLE PLASTIC DRUMS OR 42" OVERSIZED CONES INSTEAD OF STANDARD TRAFFIC CONES.

Table A

TRAFFIC CONTROL DEVICE SPACING INTERVALS WORK ACTIVITY AREA	
SPEED LIMIT	SPACING INTERVALS
35 MPH OR LESS	25 FEET
40 MPH OR GREATER	50 FEET

Table B

SIGN PLACEMENT INTERVALS			
SPEED LIMIT	*	*	*
LOW SPEED 35 MPH OR LESS	200	200	200
INTERMEDIATE SPEED 40 - 50 MPH	350	350	350
HIGH SPEED 55 MPH OR GREATER	500	500	500

NOTE: THESE SIGN PLACEMENT INTERVALS ARE BASED UPON THE POSTED REGULATORY SPEED LIMIT OF THE ROADWAY PRIOR TO BEGINNING ANY WORK.

Table C

BUFFER SPACE DISTANCES	
SPEED LIMIT	DISTANCES
LOW SPEED 35 MPH OR LESS	200
INTERMEDIATE SPEED 40 - 50 MPH	300
HIGH SPEED 55 MPH OR GREATER	400

NOTE: ADJUSTMENTS TO THE BUFFER SPACE DISTANCES MAY BE REQUIRED DUE TO FIELD CONDITIONS.

**FLAGGING OPERATIONS
MULTIPLE FLAGGERS
TWO-LANE TWO-WAY ROADWAYS
PRIMARY & SECONDARY ROUTES
WORK ACTIVITY AREA
INTERSECTIONS with
LOW SPEED
< / = 35 MPH
MULTILANE ROADWAYS**

1. See "Work Zone Traffic Control Procedures, Flagging Operations" for standard requirements regarding all flagging operations.
2. Install, maintain and conduct multiple flagger flagging operations for work zones that are present within the Departure Lane or the Approach Lane of a two-lane two-way roadway intersecting with a low speed (≤ 35 MPH) multilane roadway as illustrated by this standard drawing. Install and maintain all advance warning signs and traffic control devices as illustrated.

When the Work Activity Area is present within the Departure Lane, conduct the multiple flagger flagging operations on the two-lane two-way roadway in accordance with the requirements specific to Drawing 405-01-D(1). For the intersecting multilane roadway, set up the multiple flagger flagging operations as shown on Drawing 405-01-E(1) and Drawing 405-01-E(2).

When the Work Activity Area is present within the Approach Lane, conduct the multiple flagger flagging operations on the two-lane two-way roadway in accordance with the requirements specific to Drawing 405-01-D(2). For the intersecting multilane roadway, set up the multiple flagger flagging operations as shown on Drawing 405-01-E(1) and Drawing 405-01-E(2).
3. Ensure the Side Road flaggers or uniformed law enforcement officers controlling traffic on the multilane roadway maintain clear communications by radio or other effective method between the Side Road flaggers or the uniformed law enforcement officers and the Open Lane Flagger and the Closed Lane Flagger of the lane closure is maintained to ensure safe and efficient control of all traffic approaching the intersection.
4. If the intersection is a "traffic signal controlled" intersection, the traffic signal may or may not be placed on "normal flashing operations" when uniformed law enforcement officers are present to control and direct traffic entering and passing through the intersection. The traffic signal SHALL be placed on "normal flashing operations" when Side Road flaggers in conjunction with the Open Lane Flagger and the Closed Lane Flagger of the lane closure are present to control and direct traffic entering and passing through the intersection. Upon clearance of the limits of the intersection by the work train and all portions of the lane closure, ensure the traffic signal is returned to normal operational status and is operating in accordance with all operational functions prior to the work train and/or the lane closure encroaching upon the limits of the intersection.
5. On each roadway approach of the low speed multilane roadway, reduce the multiple travel lanes in each direction to a single travel lane to permit control of the traffic by a Side Road flagger. Relocate all traffic on these approaches into the through travel lanes nearest to the intersecting two-lane two-way roadway where the work activities are being conducted. Reduce the multiple travel lanes to a single travel lane through installation and maintenance of left and right lane closures as necessary. Install these lane closures as illustrated. Subsequent to each lane closure, install a flagging operation as illustrated.

A tangent area no less than 250 feet is required between the downstream end of the merging taper of the lane closure and the initial advance warning signs array of the flagging operation, or the changeable message sign when utilized. Dependent upon the traffic volumes, the tangent section may be extended to mitigate the development of traffic queues in advance of the beginning of the merging taper of the lane closure. On high volume roads, spotters placed at the beginning of the merging taper of the lane closure should be utilized to notify flaggers of the status of any traffic queues to allow flaggers the opportunity to minimize the time durations of the stops in an effort to minimize the traffic queues.
6. On each roadway approach intersecting the roadway where the work activities are being conducted, station the flaggers controlling traffic at the intersection immediately adjacent to the intersection as illustrated. No less than one (1) flagger is required on each approach to control traffic flow.
7. When the Work Activity Area is in the Departure Lane of the two-lane, two-way roadway use the conversion distances listed in Table 12 as the Work Activity Area progresses to a location that requires this multiple flagger flagging operation to be converted to a standard multiple flagging operation as shown on Drawing 405-01-A. In addition, comply with the requirements of Drawing 405-01-D(1) as necessary.

When the Work Activity Area is in the Approach Lane of the two-lane, two-way roadway use the conversion distances listed in Table 13 as the Work Activity Area progresses to a location that requires this multiple flagger flagging operation to be converted to a standard multiple flagging operation as shown on Drawing 405-01-A. In addition, comply with the requirements of Drawing 405-01-D(2) as necessary.

DRAWING 405-01-E(1)
 FLAGGING OPERATIONS
 MULTIPLE FLAGGERS
 TWO-LANE TWO-WAY ROADWAYS
 PRIMARY & SECONDARY
 ROUTES
 INTERSECTIONS with
 LOW SPEED
 ≤ 35 MPH
 MULTILANE ROADWAYS

SEE DRAWING 405-01-E(2) FOR THE
 TRAFFIC CONTROL REQUIREMENTS
 FOR THIS APPROACH

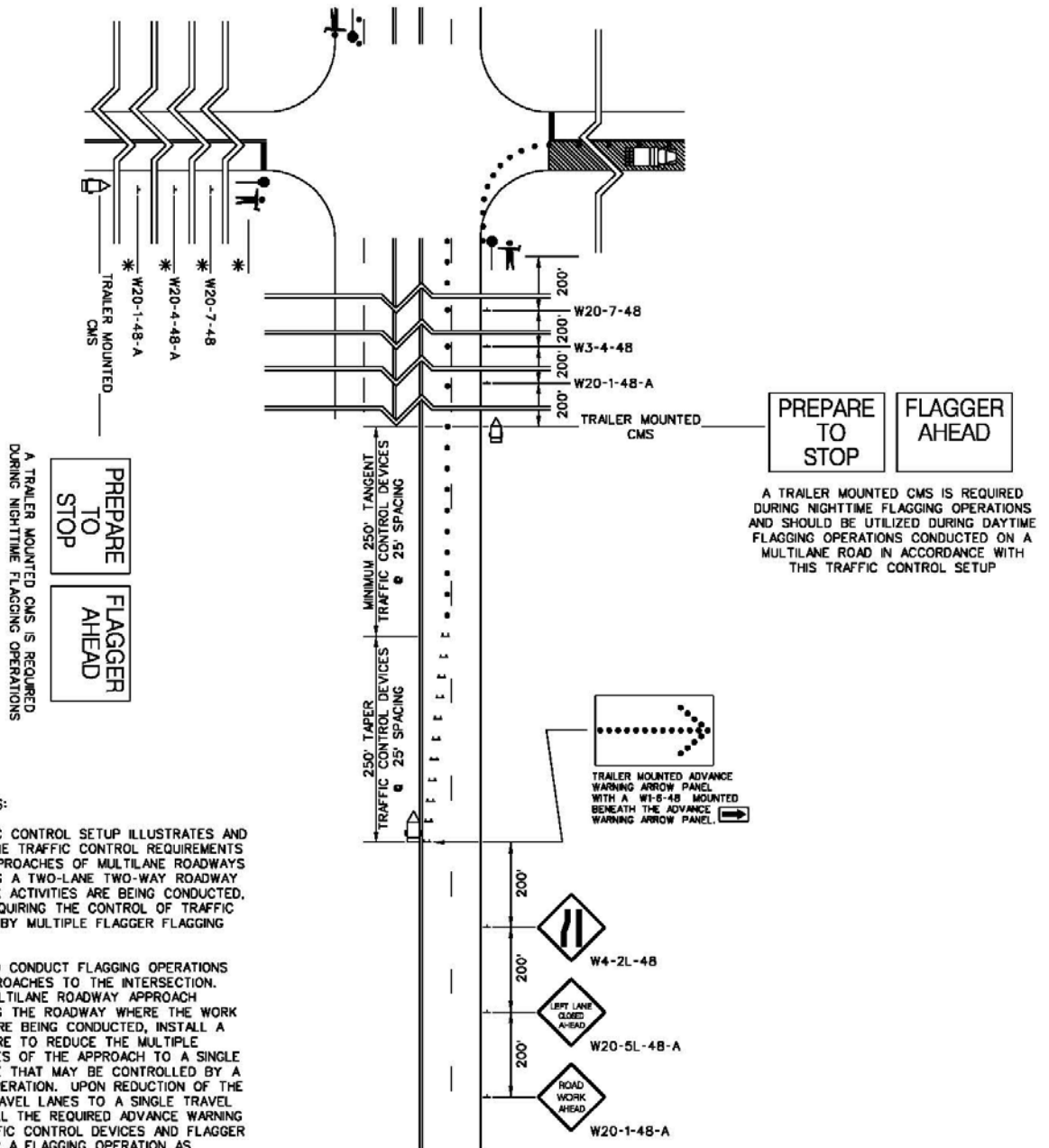

A TRAILER MOUNTED CMS IS REQUIRED
 DURING NIGHTTIME FLAGGING OPERATIONS

A TRAILER MOUNTED CMS IS REQUIRED
 DURING NIGHTTIME FLAGGING OPERATIONS
 AND SHOULD BE UTILIZED DURING DAYTIME
 FLAGGING OPERATIONS CONDUCTED ON A
 MULTILANE ROAD IN ACCORDANCE WITH
 THIS TRAFFIC CONTROL SETUP

GENERAL NOTES:

1. THIS TRAFFIC CONTROL SETUP ILLUSTRATES AND SPECIFIES THE TRAFFIC CONTROL REQUIREMENTS FOR THE APPROACHES OF MULTILANE ROADWAYS INTERSECTING A TWO-LANE TWO-WAY ROADWAY WHERE WORK ACTIVITIES ARE BEING CONDUCTED, THEREBY REQUIRING THE CONTROL OF TRAFFIC OPERATIONS BY MULTIPLE FLAGGER FLAGGING OPERATIONS.
2. INSTALL AND CONDUCT FLAGGING OPERATIONS ON ALL APPROACHES TO THE INTERSECTION. ON EACH MULTILANE ROADWAY APPROACH INTERSECTING THE ROADWAY WHERE THE WORK ACTIVITIES ARE BEING CONDUCTED, INSTALL A LANE CLOSURE TO REDUCE THE MULTIPLE TRAVEL LANES OF THE APPROACH TO A SINGLE TRAVEL LANE THAT MAY BE CONTROLLED BY A FLAGGING OPERATION. UPON REDUCTION OF THE MULTIPLE TRAVEL LANES TO A SINGLE TRAVEL LANE, INSTALL THE REQUIRED ADVANCE WARNING SIGNS, TRAFFIC CONTROL DEVICES AND FLAGGER STATION FOR A FLAGGING OPERATION AS ILLUSTRATED AND AS DIRECTED BY THE ENGINEER. DURING NIGHTTIME FLAGGING OPERATIONS, CHANGEABLE MESSAGE SIGNS ARE ALSO REQUIRED.
3. MAINTAIN TWO-WAY RADIO COMMUNICATIONS BETWEEN ALL FLAGGERS.

Drawing No. 405-01-E(2)

**FLAGGING OPERATIONS
MULTIPLE FLAGGERS
TWO-LANE TWO-WAY ROADWAYS
PRIMARY & SECONDARY ROUTES
WORK ACTIVITY AREA
INTERSECTIONS with
LOW SPEED
< / = 35 MPH
MULTILANE ROADWAYS**

1. See "Work Zone Traffic Control Procedures, Flagging Operations" for standard requirements regarding all flagging operations.
2. See Drawing 405-01-E(1) notes. All Drawing 405-01-E(1) notes shall also apply to Drawing 405-01-E(2).

DRAWING 405-01-E(2)
 FLAGGING OPERATIONS
 MULTIPLE FLAGGERS
 TWO-LANE TWO-WAY ROADWAYS
 PRIMARY & SECONDARY
 ROUTES
 INTERSECTIONS with
 LOW SPEED
 ≤ 35 MPH
 MULTILANE ROADWAYS

GENERAL NOTES:

1. THIS TRAFFIC CONTROL SETUP ILLUSTRATES AND SPECIFIES THE TRAFFIC CONTROL REQUIREMENTS FOR THE APPROACHES OF MULTILANE ROADWAYS INTERSECTING A TWO-LANE TWO-WAY ROADWAY WHERE WORK ACTIVITIES ARE BEING CONDUCTED, THEREBY REQUIRING THE CONTROL OF TRAFFIC OPERATIONS BY MULTIPLE FLAGGER FLAGGING OPERATIONS.
2. INSTALL AND CONDUCT FLAGGING OPERATIONS ON ALL APPROACHES TO THE INTERSECTION. ON EACH MULTILANE ROADWAY APPROACH INTERSECTING THE ROADWAY WHERE THE WORK ACTIVITIES ARE BEING CONDUCTED, INSTALL A LANE CLOSURE TO REDUCE THE MULTIPLE TRAVEL LANES OF THE APPROACH TO A SINGLE TRAVEL LANE THAT MAY BE CONTROLLED BY A FLAGGING OPERATION. UPON REDUCTION OF THE MULTIPLE TRAVEL LANES TO A SINGLE TRAVEL LANE, INSTALL THE REQUIRED ADVANCE WARNING SIGNS, TRAFFIC CONTROL DEVICES AND FLAGGER STATION FOR A FLAGGING OPERATION AS ILLUSTRATED AND AS DIRECTED BY THE ENGINEER. DURING NIGHTTIME FLAGGING OPERATIONS, CHANGEABLE MESSAGE SIGNS ARE ALSO REQUIRED.
3. MAINTAIN TWO-WAY RADIO COMMUNICATIONS BETWEEN ALL FLAGGERS.

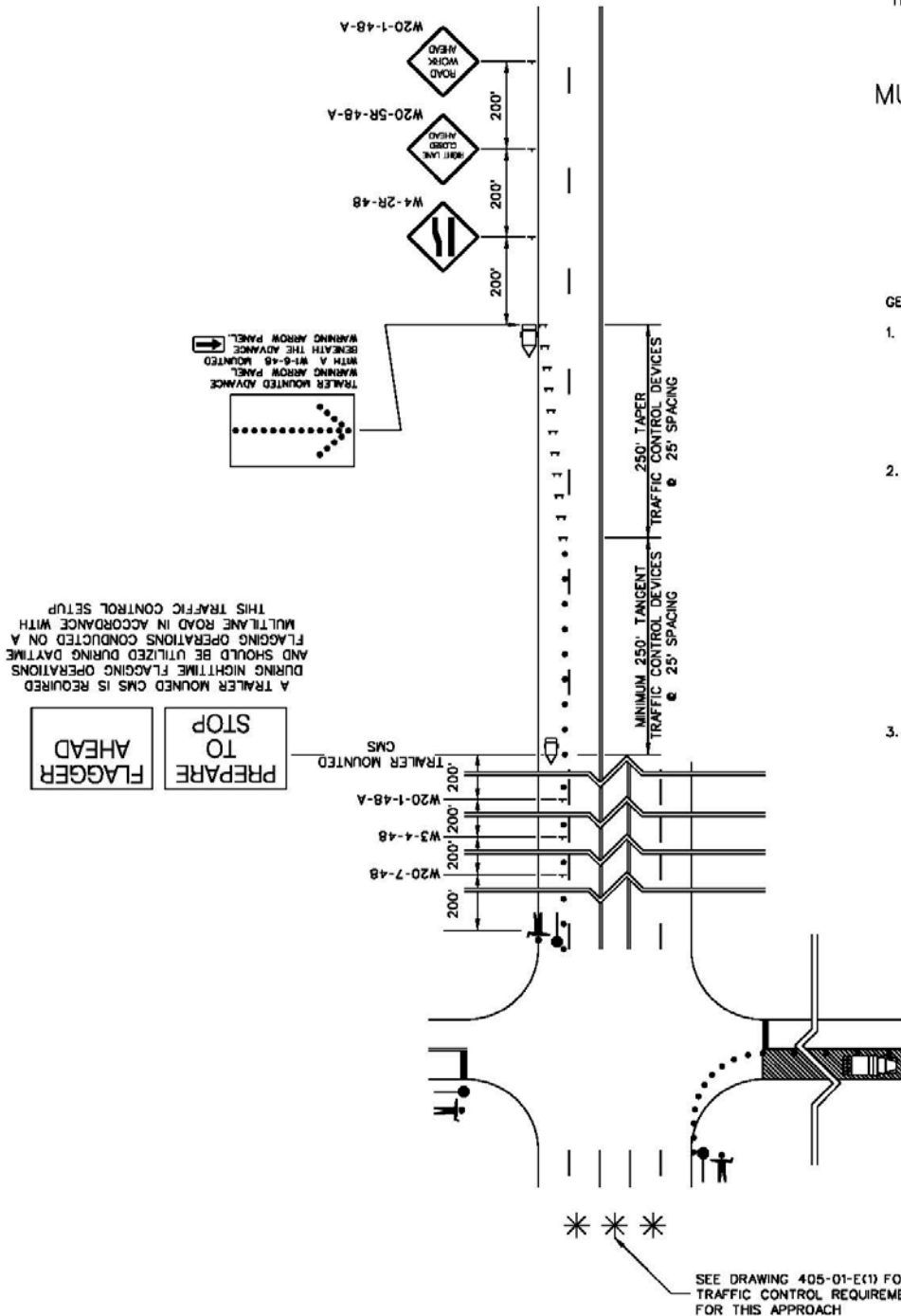

**FLAGGING OPERATIONS
MULTIPLE FLAGGERS
TWO-LANE TWO-WAY ROADWAYS
PRIMARY & SECONDARY ROUTES
WORK ACTIVITY AREA
INTERSECTIONS with
INTERMEDIATE SPEED
TO
HIGH SPEED
40 MPH – 60 MPH
MULTILANE ROADWAYS**

1. See "Work Zone Traffic Control Procedures, Flagging Operations" for standard requirements regarding all flagging operations.
2. Install, maintain and conduct multiple flagger flagging operations for work zones that are present within the Departure Lane or the Approach Lane of a two-lane two-way roadway intersecting with an intermediate to high speed (40 MPH to 60 MPH) multilane roadway as illustrated by this standard drawing. Install and maintain all advance warning signs and traffic control devices as illustrated.

When the Work Activity Area is present within the Departure Lane, conduct the multiple flagger flagging operations on the **two-lane two-way roadway** in accordance with the requirements specific to Drawing 405-01-D(1).

When the Work Activity Area is present within the Approach Lane, conduct the multiple flagger flagging operations on the **two-lane two-way roadway** in accordance with the requirements specific to Drawing 405-01-D(2).
3. Ensure the Side Road flaggers or uniformed law enforcement officers controlling traffic on the multilane roadway maintain clear communications by radio or other effective method between the Side Road flaggers or the uniformed law enforcement officers and the Open Lane Flagger and the Closed Lane Flagger of the lane closure is maintained to ensure safe and efficient control of all traffic approaching the intersection.
4. If the intersection is a "traffic signal controlled" intersection, the traffic signal may or may not be placed on "normal flashing operations" when uniformed law enforcement officers are present to control and direct traffic entering and passing through the intersection. The traffic signal SHALL be placed on "normal flashing operations" when Side Road flaggers in conjunction with the Open Lane Flagger and the Closed Lane Flagger of the lane closure are present to control and direct traffic entering and passing through the intersection. Upon clearance of the limits of the intersection by the work train and all portions of the lane closure, ensure the traffic signal is returned to normal operational status and is operating in accordance with all operational functions prior to the work train and/or the lane closure encroaching upon the limits of the intersection.
5. On each roadway approach of the intermediate to high speed (40 MPH to 60 MPH) multilane roadway, reduce the multiple travel lanes in each direction to a single travel lane to permit control of the traffic by a Side Road flagger. Relocate all traffic on these approaches into the through travel lanes nearest to the intersecting two-lane two-way roadway where the work activities are being conducted. Reduce the multiple travel lanes to a single travel lane through installation and maintenance of left and right lane closures as necessary. Install these lane closures as illustrated. Subsequent to each lane closure, install a flagging operation as illustrated.

A tangent area no less than 500 feet is required between the downstream end of the merging taper of the lane closure and the initial Advance Warning sign array of the flagging operation, or the changeable message sign when utilized. Dependent upon the traffic volumes, the tangent section may be extended to mitigate the development of traffic queues in advance of the beginning of the merging taper of the lane closure. On high volume roads, spotters placed at the beginning of the merging taper of the lane closure should be utilized to notify flaggers of the status of any traffic queues to allow flaggers the opportunity to minimize the time durations of the stops in an effort to minimize the traffic queues.
6. On each roadway approach intersecting the roadway where the work activities are being conducted, station the flaggers controlling traffic at the intersection immediately adjacent to the intersection as illustrated. No less than one (1) flagger is required on each approach to control traffic flow.

7. When the Work Activity Area is in the Departure Lane of the two-lane, two-way roadway use the conversion distances listed in Table 12 as the Work Activity Area progresses to a location that requires this multiple flagger flagging operation to be converted to a standard multiple flagging operation as shown on Drawing 405-01-A. In addition, comply with the requirements of Drawing 405-01-D(1) as necessary.

When the Work Activity Area is in the Approach Lane of the two-lane, two-way roadway use the conversion distances listed in Table 13 as the Work Activity Area progresses to a location that requires this multiple flagger flagging operation to be converted to a standard multiple flagging operation as shown on Drawing 405-01-A. In addition, comply with the requirements of Drawing 405-01-D(2) as necessary.

DRAWING 405-01-F(1)
 FLAGGING OPERATIONS
 MULTIPLE FLAGGERS
 TWO-LANE TWO-WAY ROADWAYS
 PRIMARY & SECONDARY
 ROUTES
 INTERSECTIONS with
 INTERMEDIATE SPEED
 TO
 HIGH SPEED
 40 MPH - 60 MPH
 MULTILANE ROADWAYS

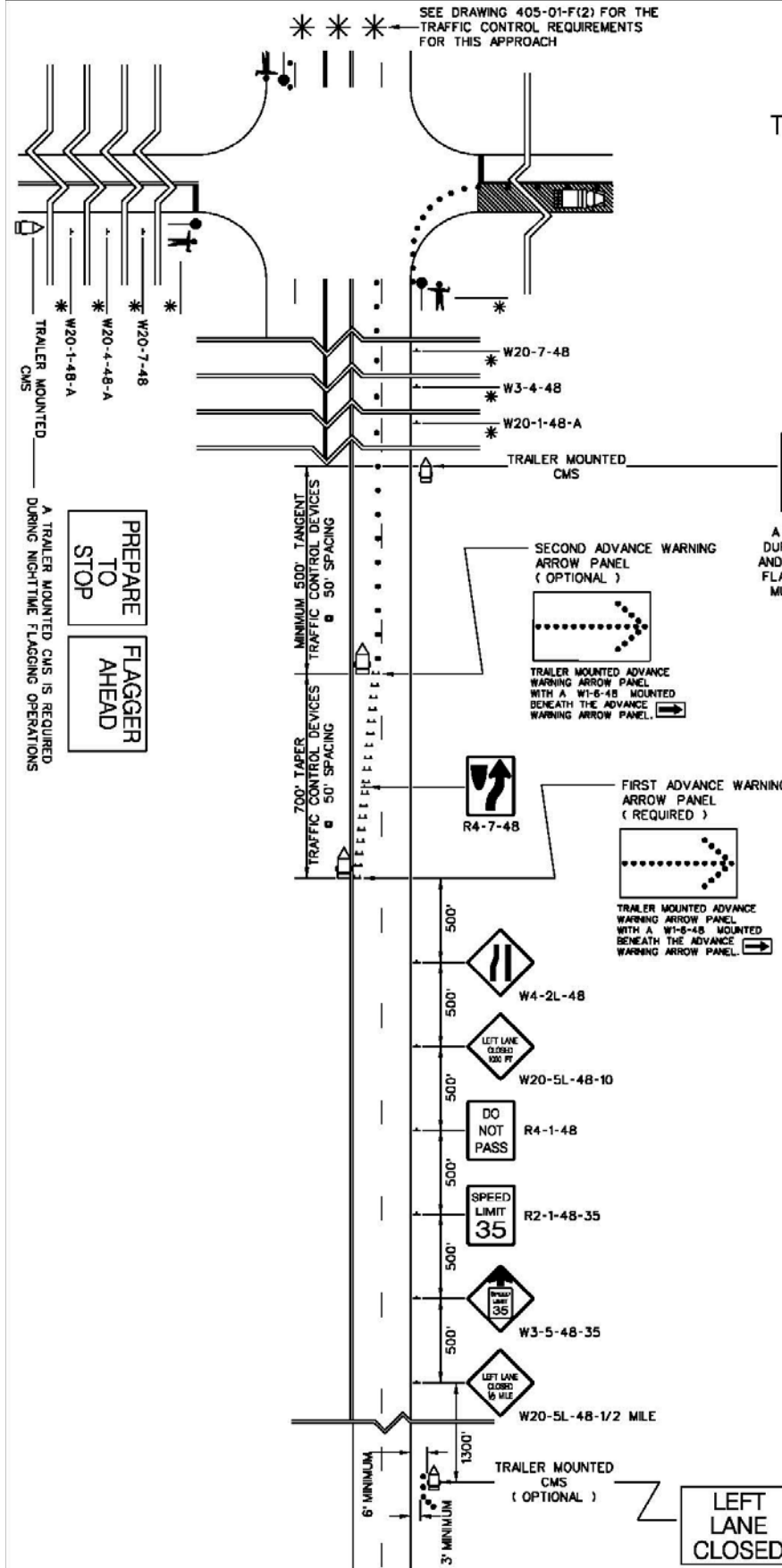

PREPARE TO STOP FLAGGER AHEAD

A TRAILER MOUNTED CMS IS REQUIRED DURING NIGHTTIME FLAGGING OPERATIONS AND SHOULD BE UTILIZED DURING DAYTIME FLAGGING OPERATIONS CONDUCTED ON A MULTILANE ROAD IN ACCORDANCE WITH THIS TRAFFIC CONTROL SETUP

Table A

SIGN PLACEMENT INTERVALS			
SPEED LIMIT	*	*	*
INTERMEDIATE SPEED 40 - 50 MPH	350	350	350
HIGH SPEED 55 MPH OR GREATER	500	500	500

NOTE: THESE SIGN PLACEMENT INTERVALS ARE BASED UPON THE POSTED REGULATORY SPEED LIMIT OF THE ROADWAY PRIOR TO BEGINNING ANY WORK UNLESS OTHERWISE DIRECTED.

GENERAL NOTES:

1. THIS TRAFFIC CONTROL SETUP ILLUSTRATES AND SPECIFIES THE TRAFFIC CONTROL REQUIREMENTS FOR THE APPROACHES TO MULTILANE ROADWAYS INTERSECTING A TWO-LANE TWO-WAY ROADWAY WHERE WORK ACTIVITIES ARE BEING CONDUCTED, THEREBY REQUIRING THE CONTROL OF TRAFFIC OPERATIONS BY MULTIPLE FLAGGER FLAGGING OPERATIONS.
2. INSTALL AND CONDUCT FLAGGING OPERATIONS ON ALL APPROACHES TO THE INTERSECTION. ON EACH MULTILANE ROADWAY APPROACH INTERSECTING THE ROADWAY WHERE THE WORK ACTIVITIES ARE BEING CONDUCTED, INSTALL A LANE CLOSURE TO REDUCE THE MULTIPLE TRAVEL LANES OF THE APPROACH TO A SINGLE TRAVEL LANE THAT MAY BE CONTROLLED BY A FLAGGING OPERATION. UPON REDUCTION OF THE MULTIPLE TRAVEL LANES TO A SINGLE TRAVEL LANE, INSTALL THE REQUIRED ADVANCE WARNING SIGNS, TRAFFIC CONTROL DEVICES AND FLAGGER STATION FOR A FLAGGING OPERATION AS ILLUSTRATED AND AS DIRECTED BY THE ENGINEER. DURING NIGHTTIME FLAGGING OPERATIONS, CHANGEABLE MESSAGE SIGNS ARE ALSO REQUIRED.
3. MAINTAIN TWO-WAY RADIO COMMUNICATIONS BETWEEN ALL FLAGGERS.

Drawing No. 405-01-F(2)

**FLAGGING OPERATIONS
MULTIPLE FLAGGERS
TWO-LANE TWO-WAY ROADWAYS
PRIMARY & SECONDARY ROUTES
WORK ACTIVITY AREA
INTERSECTIONS with
INTERMEDIATE SPEED
TO
HIGH SPEED
40 MPH – 60 MPH
MULTILANE ROADWAYS**

1. See "Work Zone Traffic Control Procedures, Flagging Operations" for standard requirements regarding all flagging operations.
2. See Drawing 405-01-F(1) notes. All Drawing 405-01-F(1) notes shall also apply to Drawing 405-01-F(2).

DRAWING 405-01-F(2)
 FLAGGING OPERATIONS
 MULTIPLE FLAGGERS
 TWO-LANE TWO-WAY ROADWAYS
 PRIMARY & SECONDARY
 ROUTES
 INTERSECTIONS with
 INTERMEDIATE SPEED
 TO
 HIGH SPEED
 40 MPH - 60 MPH
 MULTILANE ROADWAYS

GENERAL NOTES:

1. THIS TRAFFIC CONTROL SETUP ILLUSTRATES AND SPECIFIES THE TRAFFIC CONTROL REQUIREMENTS FOR THE APPROACHES OF MULTILANE ROADWAYS INTERSECTING A TWO-LANE TWO-WAY ROADWAY WHERE WORK ACTIVITIES ARE BEING CONDUCTED, THEREBY REQUIRING THE CONTROL OF TRAFFIC OPERATIONS BY MULTIPLE FLAGGER FLAGGING OPERATIONS.
2. INSTALL AND CONDUCT FLAGGING OPERATIONS ON ALL APPROACHES TO THE INTERSECTION. ON EACH MULTILANE ROADWAY APPROACH INTERSECTING THE ROADWAY WHERE THE WORK ACTIVITIES ARE BEING CONDUCTED, INSTALL A LANE CLOSURE TO REDUCE THE MULTIPLE TRAVEL LANES OF THE APPROACH TO A SINGLE TRAVEL LANE THAT MAY BE CONTROLLED BY A FLAGGING OPERATION. UPON REDUCTION OF THE MULTIPLE TRAVEL LANES TO A SINGLE TRAVEL LANE, INSTALL THE REQUIRED ADVANCE WARNING SIGNS, TRAFFIC CONTROL DEVICES AND FLAGGER STATION FOR A FLAGGING OPERATION AS ILLUSTRATED AND AS DIRECTED BY THE ENGINEER. DURING NIGHTTIME FLAGGING OPERATIONS, CHANGEABLE MESSAGE SIGNS ARE ALSO REQUIRED.
3. MAINTAIN TWO-WAY RADIO COMMUNICATIONS BETWEEN ALL FLAGGERS.

Table A

SIGN PLACEMENT INTERVALS			
SPEED LIMIT	*	*	*
INTERMEDIATE SPEED 40 - 50 MPH	350	350	350
HIGH SPEED 55 MPH OR GREATER	500	500	500

NOTE: THESE SIGN PLACEMENT INTERVALS ARE BASED UPON THE POSTED REGULATORY SPEED LIMIT OF THE ROADWAY PRIOR TO BEGINNING ANY WORK UNLESS OTHERWISE DIRECTED.

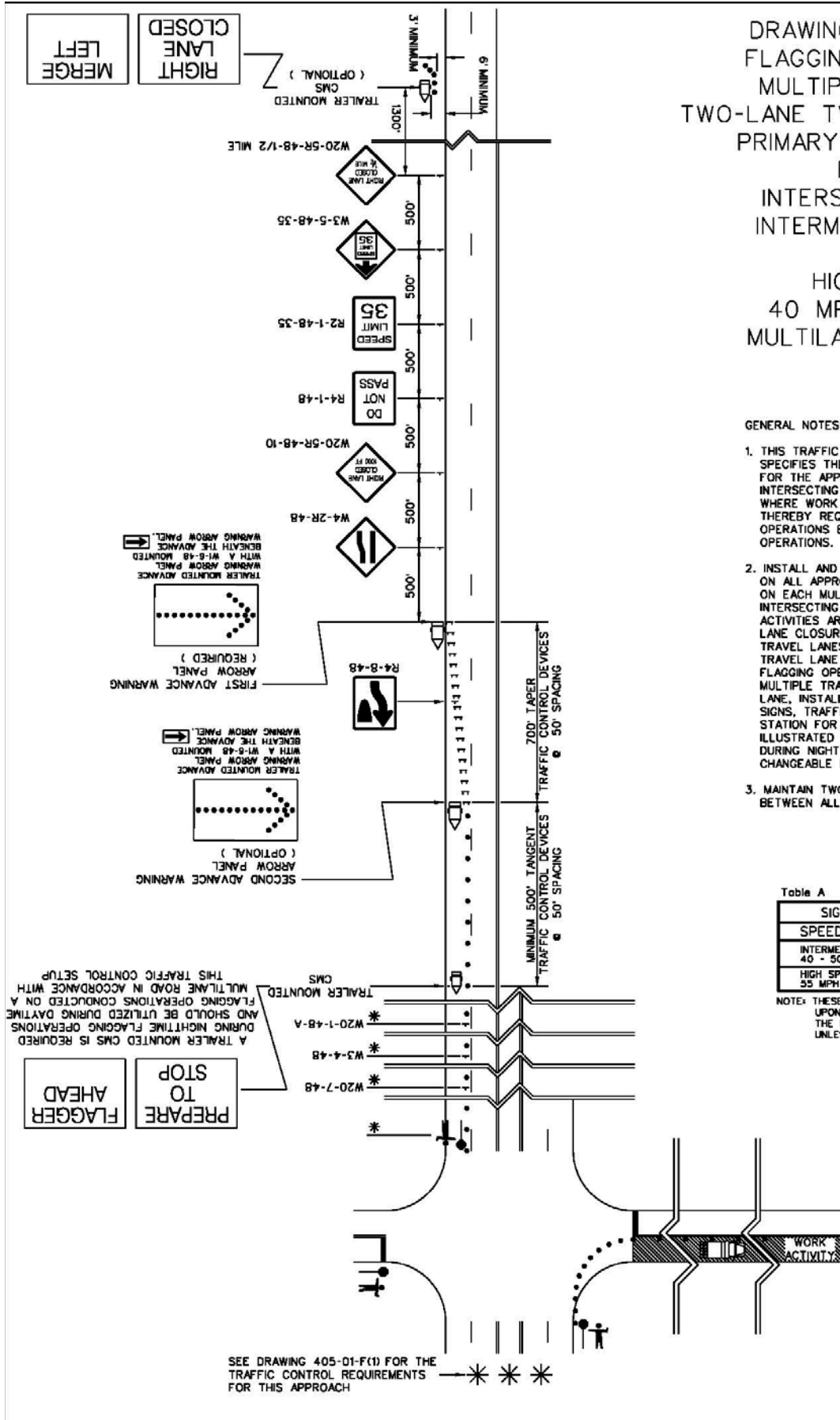

**FLAGGING OPERATIONS
SINGLE FLAGGER OPERATION
LOW VOLUME
LOW SPEED TO INTERMEDIATE SPEED
TWO-LANE TWO-WAY ROADWAYS
PRIMARY & SECONDARY ROUTES**

1. Install and conduct single flagger operations as specified by this manual, the MUTCD and the SCDOT "Flagger's Handbook", latest edition. Install all advance warning signs prior to beginning the flagging operation and remove or cover the signs immediately upon termination of the flagging operation.
2. **Lane closures controlled by a single flagger operation are restricted to low volume low speed to intermediate speed routes during daytime hours ONLY, except during emergency operations as directed by the Director of Maintenance.**
3. Flagging operations shall direct traffic around the work activities and maintain continuous traffic flow, therefore, stopped traffic shall not be required to stop for time durations greater than 5 minutes unless otherwise directed by the District Engineering Administrator.
4. The work activity area of a lane closure controlled by a single flagger operation is restricted to a maximum distance of 200 feet.
5. Station the flagger at a location no further than 200 feet from the first traffic control device in the approach taper and no further than 200 feet from the last traffic control device in the downstream taper.
6. If two different lane closures controlled by flagging operations are in place on the same roadway at the same time, separate these lane closures by no less than 2 miles. Maintain a separation of no less than 2 miles from the end of the downstream taper of the first lane closure to the beginning of the approach taper of the second lane closure.
7. Conduct the work in such a manner to avoid encroaching into the adjacent travel lane open to traffic.
8. Install advance warning signs mounted on portable sign supports no less than 4 feet from the near edge of the sign to the near edge of an adjacent travel lane on roadways with grass shoulders and no less than 6 feet from the near edge of the sign to the near edge of an adjacent travel lane on roadways with paved shoulders. When a curb & gutter is present, install the sign no less than 2 feet from the near edge of the sign to the face of the curb.
9. **During single flagger flagging operations, the minimum mounting height of ALL signs mounted on portable sign supports is 5 feet from the bottom edge of the sign to the ground or surface on which the sign support is located.**
10. Measure all advance warning sign locations from the beginning of the tapers.
11. Install the advance warning signs for a single flagger operation at spacing intervals based on the posted regulatory speed limit of the roadway prior to beginning any work. See *Table 14, Advance Warning Sign Placement Intervals for Single Flagger Operations (Drawing No. 405-02)*.

Table 14 Advance Warning Sign Placement Intervals for Single Flagger Operations (Drawing No. 405-02)

LOW SPEED 35 MPH or LESS	200 / 200 / 200 Feet
INTERMEDIATE SPEED 40 - 50 MPH	350 / 350 / 350 Feet

12. The advance warning sign placement intervals indicated on a traffic control plan or the above chart are for normal conditions. Adjustments to the distance intervals between the signs may be necessary due to existing signs, driveways, intersecting roadways, etc.
14. Equip each flagger with a 24" X 24" Stop/Slow paddle with 8 inch high letters mounted on a rigid handle no less than 7 feet long.

DRAWING 405-02
 FLAGGING OPERATIONS
 SINGLE FLAGGER OPERATION
 LOW VOLUME
 LOW SPEED TO INTERMEDIATE SPEED
 TWO-LANE TWO-WAY ROADWAYS
 PRIMARY & SECONDARY
 ROUTES

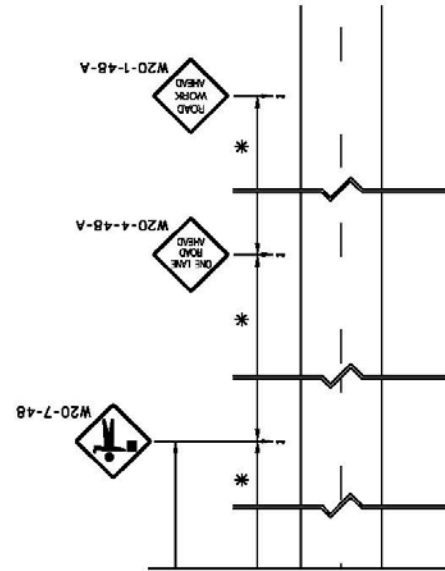
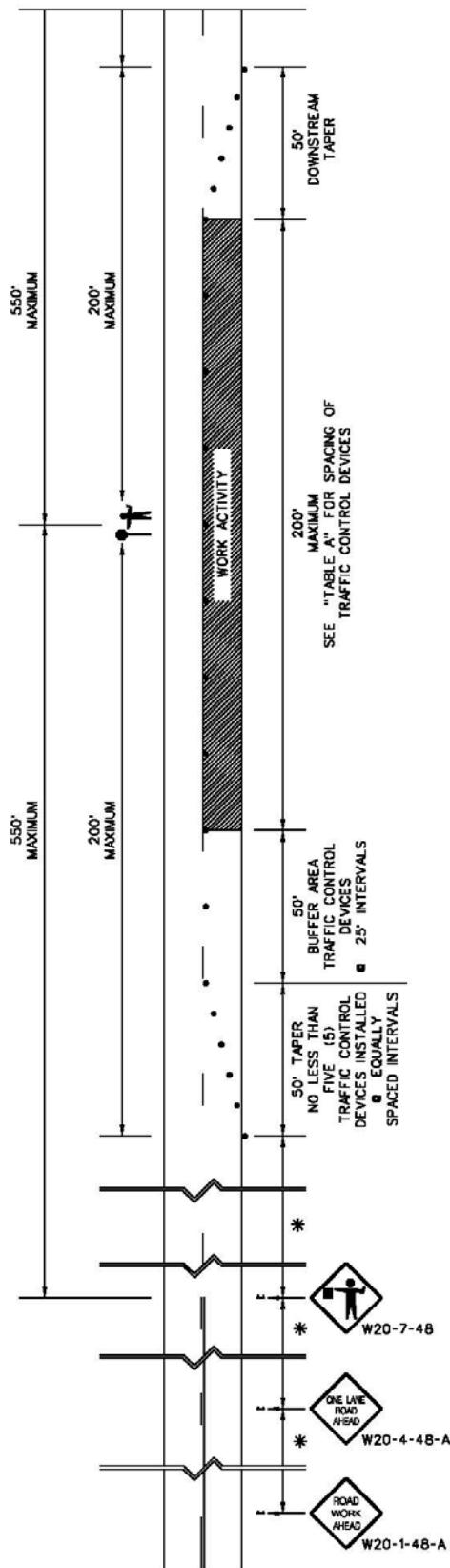

Table A

TRAFFIC CONTROL DEVICE SPACING INTERVALS WORK ACTIVITY AREA	
SPEED LIMIT	SPACING INTERVALS
≤ 35 MPH	25 FEET
40 - 50 MPH	50 FEET

Table B

SIGN PLACEMENT INTERVALS			
SPEED LIMIT	*	*	*
LOW SPEED ≤ 35 MPH	200	200	200
INTERMEDIATE SPEED 40 - 50 MPH	350	350	350

SPECIAL NOTE:

LOCATE THE FLAGGER STATION AS NECESSARY TO MAXIMIZE VISIBILITY OF THE FLAGGER TO AN APPROACHING MOTORIST WITHOUT EXCEEDING THE MAXIMUM 200' DISTANCE FROM THE FLAGGER STATION TO THE BEGINNING OF THE APPROACH TAPER OR THE END OF THE DOWNSTREAM TAPER.

LANE CLOSURES

***PRIMARY
&
SECONDARY
ROUTES***

STANDARD DRAWING NO. 505-01

Through

STANDARD DRAWING NO. 505-04-C

Drawing No. 505-01

**LANE CLOSURE
LOW SPEED MULTILANE
< / = 35 MPH
PRIMARY & SECONDARY ROUTES**

1. These lane closures are restricted to maximum distances of 2 miles unless otherwise directed by the District Engineering Administrator.
2. Measure all advance warning sign locations from the beginning of the taper.
3. Install advance warning signs mounted on portable sign supports no less than 4 feet from the near edge of the sign to the near edge of an adjacent travel lane on roadways with grass shoulders and no less than 6 feet from the near edge of the sign to the near edge of an adjacent travel lane on roadways with paved shoulders. When a curb & gutter is present, install the sign no less than 2 feet from the near edge of the sign to the face of the curb.
4. On primary and secondary routes, the minimum mounting height of signs mounted on portable sign supports is 1 foot during this traffic control setup.
5. The advance warning sign placement intervals illustrated are for normal conditions. Adjustments to the distance intervals between the signs may be necessary due to sight distance restrictions such as curves and hills.
6. Install and operate a trailer mounted advance warning arrow panel within the taper of a single lane closure. Place the advance warning arrow panel on the roadway shoulder at the beginning of the taper. However, where the shoulders are narrow or site conditions restrict the use of the shoulder areas adjacent to the beginning of the taper, place the advance warning arrow panel behind the channelizing devices as close as practical to the beginning of the taper. Placement of the advance warning arrow panel at the beginning of the taper is preferred.
7. During daytime hours, 28" or 36" standard traffic cones may be utilized for delineation of the lane closure. The 28" and 36" standard traffic cones used during daytime hours are not required to be reflectorized.
8. During nighttime hours, portable plastic drums or 42" oversized traffic cones are required for delineation of the lane closure.
9. If a daytime work operation extends into the nighttime hours, replace 28" or 36" standard traffic cones with portable plastic drums or 42" oversized traffic cones.
10. Reflectorize all portable plastic drums and 42" oversized traffic cones with Type III flexible microprismatic retroreflective sheeting.
11. If work is being conducted at two different locations at the same time in the same travel lane on a low speed roadway, \leq 35 MPH, separate the two locations by no less than 1 mile from the end of the first lane closure to the beginning of the taper of the second lane closure.
12. If work is being conducted at two different locations at the same time in different travel lanes on a low speed roadway, \leq 35 MPH, separate the two locations by no less than 2 miles from the end of the first lane closure to the beginning of the taper of the second lane closure.
13. When a truck mounted attenuator is used, maintain the truck mounted attenuator approximately 100 feet in advance of the work activities.
14. Conduct the work in such a manner to avoid encroaching into the adjacent travel lane open to traffic.

15. A trailer mounted changeable message sign is not required but is optional. When a trailer mounted changeable message sign is utilized, install the changeable message sign on the shoulder of the roadway no less than 6 feet from the near edge of the sign to the near edge of the adjacent travel lane when space is available. When the 6 foot space or right-of-way is unavailable, place the trailer mounted changeable message sign at the greatest possible distance up to 6 feet from the near edge of the adjacent travel lane. When a trailer mounted changeable message sign is placed within the limits of a paved shoulder or remains in place adjacent to a travel lane regardless of shoulder type when inoperative, supplement the trailer mounted changeable message sign location with no less than 5 portable plastic drums placed between the sign and the adjacent travel lane for delineation of the sign location. This requirement for delineation of the sign location applies at all times under the aforementioned conditions during which the sign is within 15 feet of the near edge of a travel lane open to traffic. Use of 28" or 36" standard traffic cones or 42" oversized traffic cones as substitutes for the portable plastic drums in this application is PROHIBITED. The sign shall flash alternately to read "RIGHT LANE CLOSED", "MERGE LEFT" or "LEFT LANE CLOSED", "MERGE RIGHT" as necessary. Also, the messages shall flash at a rate to permit motorists to read both messages at least once.

16. This traffic control setup for a lane closure is only acceptable on low speed roadways with a posted regulatory speed of 35 MPH or less.

DRAWING 505-01
 LANE CLOSURE
 LOW SPEED MULTILANE
 ≤ 35 MPH
 PRIMARY & SECONDARY ROUTES

(OPTIONAL)
 TRUCK MOUNTED
 ATTENUATOR

WHEN A TRUCK MOUNTED
 ATTENUATOR IS UTILIZED,
 OPERATE AS FOLLOWS:

THE TRUCK MOUNTED
 ATTENUATOR SHALL
 REMAIN APPROXIMATELY
 100' IN ADVANCE OF THE
 WORK ACTIVITY
 (INCLUDING PERSONNEL
 AND MACHINERY) AT
 ALL TIMES.

AN ADVANCE WARNING
 ARROW PANEL IS
 OPTIONAL ON THIS
 VEHICLE. IF THE
 VEHICLE IS ADVANCED
 BEYOND 150' FROM
 THE END OF THE TAPER,
 AN ADVANCE WARNING
 ARROW PANEL ON THIS
 VEHICLE SHALL OPERATE
 IN THE "FOUR CORNER"
 CAUTION MODE DISPLAYING
 FOUR LAMPS WITH ONE
 LAMP IN EACH CORNER.

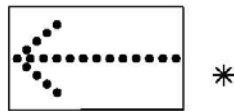
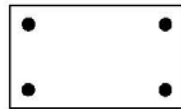

TRAILER MOUNTED ADVANCE
 WARNING ARROW PANEL
 WITH A W1-6-48 MOUNTED
 BENEATH THE ADVANCE
 WARNING ARROW PANEL.

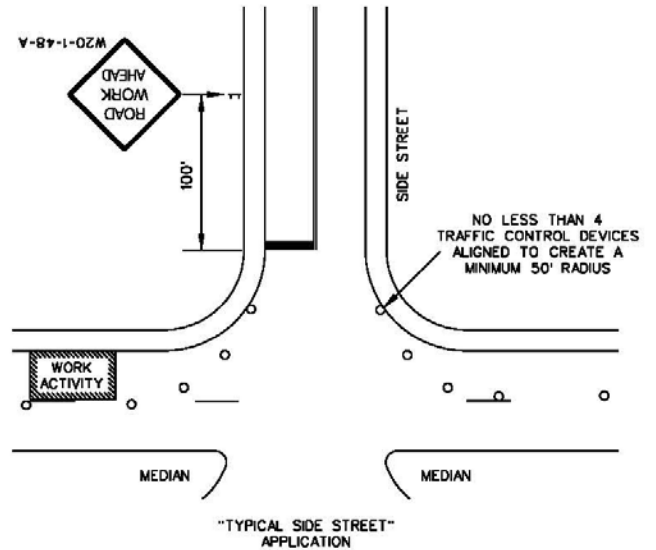
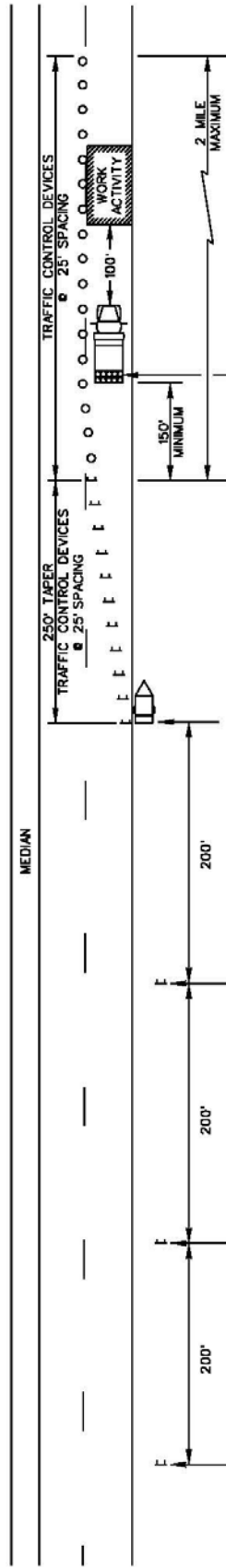

* LEFT LANE CLOSURE

- 1.) SIGNS ILLUSTRATED ARE FOR A RIGHT LANE CLOSURE.
- 2.) WHEN CLOSING THE LEFT TRAVEL LANE, USE THE FOLLOWING:
 - 1 - W4-2L-48
 - 1 - W20-5L-48-A
- 3.) THE FLASHING ARROW AND W1-6-48 SHALL POINT TO THE RIGHT.

Drawing No. 505-02

**DUAL LANE CLOSURE
LOW SPEED MULTILANE
< / = 35 MPH
PRIMARY & SECONDARY ROUTES**

1. These lane closures are restricted to maximum distances of 2 miles unless otherwise directed by the District Engineering Administrator.
2. Measure all advance warning sign locations from the beginning of the taper.
3. Install advance warning signs mounted on portable sign supports no less than 4 feet from the near edge of the sign to the near edge of an adjacent travel lane on roadways with grass shoulders and no less than 6 feet from the near edge of the sign to the near edge of an adjacent travel lane on roadways with paved shoulders. When a curb & gutter is present, install the sign no less than 2 feet from the near edge of the sign to the face of the curb.
4. **During dual lane closures on low speed multilane primary and secondary routes, the minimum mounting height of signs mounted on portable sign supports is 5 feet from the ground to the bottom edge of the sign.**
5. The advance warning sign placement intervals illustrated are for normal conditions. Adjustments to the distance intervals between the signs may be necessary due to sight distance restrictions such as curves and hills.
6. Install and operate two trailer mounted advance warning arrow panels within each taper of a dual lane closure on low speed primary and secondary roadways. Place one advance warning arrow panel at the beginning of each taper and a second advance warning arrow panel within the closure at the downstream end of each taper. However, where the shoulders are narrow or site conditions restrict the use of the shoulder areas adjacent to the beginning of the first taper of a dual lane closure, place the first advance warning arrow panel behind the channelizing devices of the first taper as close as practical to the beginning of the first taper. Placement of the first advance warning arrow panel at the beginning of the first taper of a dual lane closure is preferred.
7. Delineate dual lane closure with portable plastic drums or 42" oversized traffic cones. Delineation of dual lane closures with 28" or 36" standard traffic cones is PROHIBITED.
8. Reflectorize all portable plastic drums and 42" oversized traffic cones with Type III flexible microprismatic retroreflective sheeting.
9. If work is being conducted at two different locations at the same time in the same travel lane on a low speed roadway, ≤ 35 MPH, separate the two locations by no less than 1 mile from the end of the first lane closure to the beginning of the taper of the second lane closure.
10. If work is being conducted at two different locations at the same time in different travel lanes on a low speed roadway, ≤ 35 MPH, separate the two locations by no less than 2 miles from the end of the first lane closure to the beginning of the taper of the second lane closure.
11. When a truck mounted attenuator is used, maintain the truck mounted attenuator approximately 100 feet in advance of the work activities.
12. Conduct the work in such a manner to avoid encroaching into the adjacent travel lane open to traffic.

13. A trailer mounted changeable message sign is not required but is optional. When a trailer mounted changeable message sign is utilized, install the changeable message sign on the shoulder of the roadway no less than 6 feet from the near edge of the sign to the near edge of the adjacent travel lane when space is available. When the 6 foot space or right-of-way is unavailable, place the trailer mounted changeable message sign at the greatest possible distance up to 6 feet from the near edge of the adjacent travel lane. When a trailer mounted changeable message sign is placed within the limits of a paved shoulder or remains in place adjacent to a travel lane regardless of shoulder type when inoperative, supplement the trailer mounted changeable message sign location with no less than 5 portable plastic drums placed between the sign and the adjacent travel lane for delineation of the sign location. This requirement for delineation of the sign location applies at all times under the aforementioned conditions during which the sign is within 15 feet of the near edge of a travel lane open to traffic. Use of 28" or 36" standard traffic cones or 42" oversized traffic cones as substitutes for the portable plastic drums in this application is PROHIBITED. The sign shall flash alternately to read "LEFT TWO LANES CLOSED", "MERGE RIGHT" or "RIGHT TWO LANES CLOSED", "MERGE LEFT" as necessary. Also, the messages shall flash at a rate to permit motorists to read both messages at least once.

14. This traffic control setup for a dual lane closure is only acceptable on low speed multilane roadways with a posted regulatory speed of 35 MPH or less.

DRAWING 505-02
 DUAL LANE CLOSURE
 LOW SPEED MULTILANE
 ≤ 35 MPH
 PRIMARY & SECONDARY ROUTES

**TRUCK MOUNTED
 ATTENUATOR**

WHEN A TRUCK MOUNTED ATTENUATOR IS UTILIZED, OPERATE AS FOLLOWS:

THE TRUCK MOUNTED ATTENUATOR SHALL REMAIN APPROXIMATELY 100' IN ADVANCE OF THE WORK ACTIVITY (INCLUDING PERSONNEL AND MACHINERY) AT ALL TIMES.

AN ADVANCE WARNING ARROW PANEL IS OPTIONAL ON THIS VEHICLE. IF THE VEHICLE IS ADVANCED BEYOND 150' FROM THE END OF THE TAPER, AN ADVANCE WARNING ARROW PANEL ON THIS VEHICLE SHALL OPERATE IN THE "FOUR CORNER" CAUTION MODE DISPLAYING FOUR LAMPS WITH ONE LAMP IN EACH CORNER.

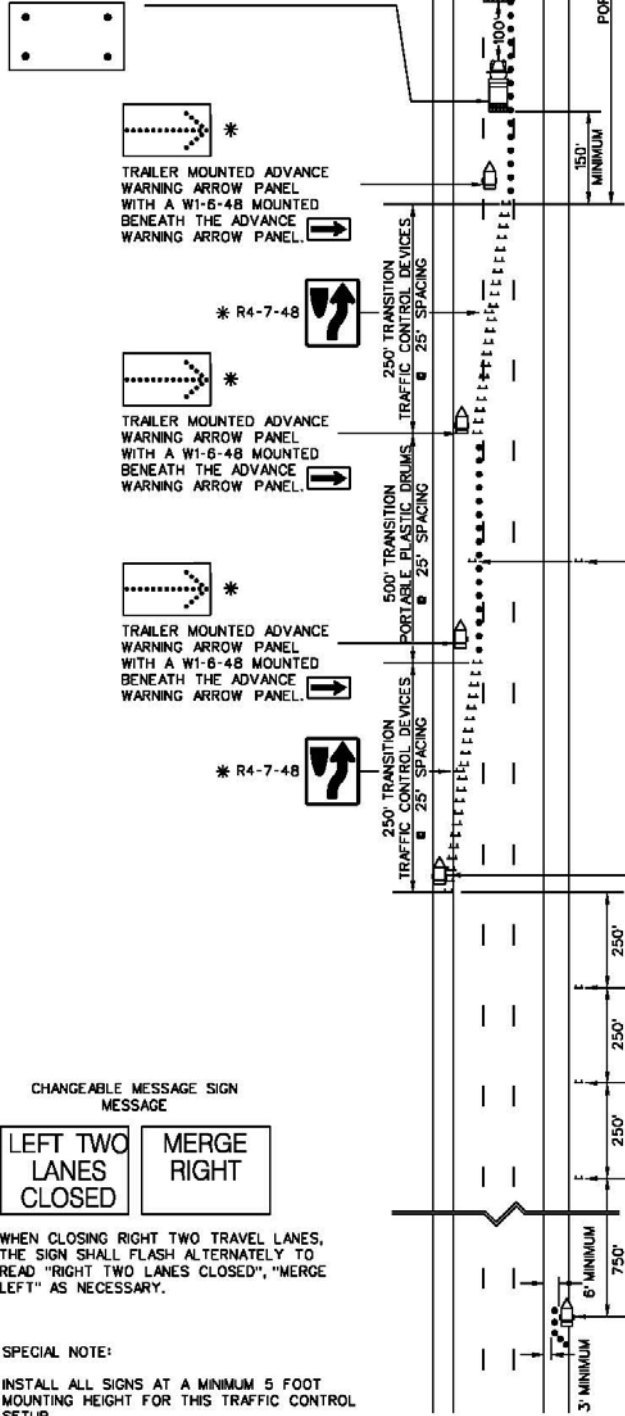

*** RIGHT LANE CLOSURE**

- 1.) SIGNS ILLUSTRATED ARE FOR CLOSURE OF THE LEFT TWO LANES.
- 2.) WHEN CLOSING THE RIGHT TWO LANES, USE THE FOLLOWING:
 - 1 - W20-5aR-48-5
 - 3 - W4-2R-48
 - 2 - R4-B-48
- 3.) THE FLASHING ARROWS AND W1-6-48 SIGNS SHALL POINT TO THE LEFT.

CHANGEABLE MESSAGE SIGN
 MESSAGE

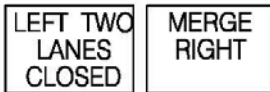

WHEN CLOSING RIGHT TWO TRAVEL LANES, THE SIGN SHALL FLASH ALTERNATELY TO READ "RIGHT TWO LANES CLOSED", "MERGE LEFT" AS NECESSARY.

SPECIAL NOTE:

INSTALL ALL SIGNS AT A MINIMUM 5 FOOT MOUNTING HEIGHT FOR THIS TRAFFIC CONTROL SETUP.

INSTALL 5 DRUMS TO DELINEATE CHANGEABLE MESSAGE SIGN LOCATION WHEN THE SIGN IS PLACED WITHIN THE LIMITS OF A PAVED SHOULDER OR THE SIGN MAY REMAIN IN PLACE WHILE INOPERATIVE REGARDLESS OF SHOULDER TYPE

**LANE CLOSURE
INTERMEDIATE SPEED TO HIGH SPEED
40 MPH - 60 MPH
MULTILANE PRIMARY & SECONDARY ROUTES**

1. These lane closures are restricted to maximum distances of 2 miles unless otherwise directed by the District Engineering Administrator.
2. Measure all advance warning sign locations from the beginning of the taper.
3. Install advance warning signs mounted on portable sign supports no less than 4 feet from the near edge of the sign to the near edge of an adjacent travel lane on roadways with grass shoulders and no less than 6 feet from the near edge of the sign to the near edge of an adjacent travel lane on roadways with paved shoulders. When a curb & gutter is present, install the sign no less than 2 feet from the near edge of the sign to the face of the curb.
4. On primary and secondary routes, the minimum mounting height of signs mounted on portable sign supports is 1 foot during this traffic control setup.
5. **In accordance with the requirements of the MUTCD, during lane closures on intermediate to high speed multilane primary and secondary routes with exit ramps, mount temporary "Exit" signs (E5-1) (M-1025) located within a temporary gore area at a minimum height of 7 feet from the pavement surface to the bottom edge of the sign.**
6. The advance warning sign placement intervals illustrated are for normal conditions. Adjustments to the distance intervals between the signs may be necessary due to sight distance restrictions such as curves and hills.
7. Install and operate two trailer mounted advance warning arrow panels within the taper of a single lane closure for improved visibility by the motorists. However, no less than one trailer mounted advance warning arrow panel within the taper of a single lane closure is required. When operating a single trailer mounted advance warning arrow panel, place the arrow panel on the roadway shoulder at the beginning of the taper. On roadways where the shoulders may be narrow or site conditions restrict the use of the shoulder areas, place the trailer mounted advance warning arrow panel behind the channelizing devices of the taper as close as practical to the beginning of the taper. Placement of the trailer mounted advance warning arrow panel at the start of the taper is preferred. When utilizing two trailer mounted advance warning arrow panels within the taper of a single lane closure, place one arrow panel on the roadway shoulder at the beginning of the taper and a second arrow panel within the closure at the downstream end of the taper. However, where the shoulders are narrow or site conditions restrict the use of the shoulder areas, place the first trailer mounted advance warning arrow panel behind the channelizing devices of the taper as close as practical to the beginning of the taper. Placement of the first trailer mounted advance warning arrow panel at the beginning of the taper is preferred.
8. During daytime hours, 28" or 36" standard traffic cones may be utilized for delineation of the lane closure. The 28" and 36" standard traffic cones used during daytime hours are not required to be reflectorized.
9. During nighttime hours, portable plastic drums or 42" oversized traffic cones are required for delineation of the lane closure.
10. If a daytime work operation extends into the nighttime hours, replace the 28" or 36" standard traffic cones with portable plastic drums or 42" oversized traffic cones.
11. Reflectorize all portable plastic drums and 42" oversized traffic cones with Type III flexible microprismatic retroreflective sheeting.
12. If work is being conducted at two different locations at the same time in the same travel lane on an intermediate to high speed roadway, 40 to 60 MPH, separate the two locations by no less than 2 miles from the end of the first lane closure to the beginning of the taper of the second lane closure.
13. If work is being conducted at two different locations at the same time in different travel lanes on an intermediate to high speed roadway, 40 to 60 MPH, separate the two locations by no less than 4 miles from the end of the first lane closure to the beginning of the taper of the second lane closure.
14. When a truck mounted attenuator is used, maintain the truck mounted attenuator approximately 100 feet in advance of the work activities.

15. Conduct the work in such a manner to avoid encroaching into the adjacent travel lane open to traffic.

16. A trailer mounted changeable message sign is not required but is optional. When a trailer mounted changeable message sign is utilized, install the changeable message sign on the shoulder of the roadway no less than 6 feet from the near edge of the sign to the near edge of the adjacent travel lane when space is available. When the 6 foot space or right-of-way is unavailable, place the trailer mounted changeable message sign at the greatest possible distance up to 6 feet from the near edge of the adjacent travel lane. When a trailer mounted changeable message sign is placed within the limits of a paved shoulder or remains in place adjacent to a travel lane regardless of shoulder type when inoperative, supplement the trailer mounted changeable message sign location with no less than 5 portable plastic drums placed between the sign and the adjacent travel lane for delineation of the sign location. This requirement for delineation of the sign location applies at all times under the aforementioned conditions during which the sign is within 15 feet of the near edge of a travel lane open to traffic. Use of 28" or 36" standard traffic cones or 42" oversized traffic cones as substitutes for the portable plastic drums in this application is PROHIBITED. The sign shall flash alternately to read "RIGHT LANE CLOSED", "MERGE LEFT" or "LEFT LANE CLOSED", "MERGE RIGHT" as necessary. Also, the messages shall flash at a rate to permit motorists to read both messages at least once.

DRAWING 505-03-A
 LANE CLOSURE
 INTERMEDIATE SPEED TO HIGH SPEED
 40 MPH - 60 MPH
 MULTILANE
 PRIMARY & SECONDARY
 ROUTES

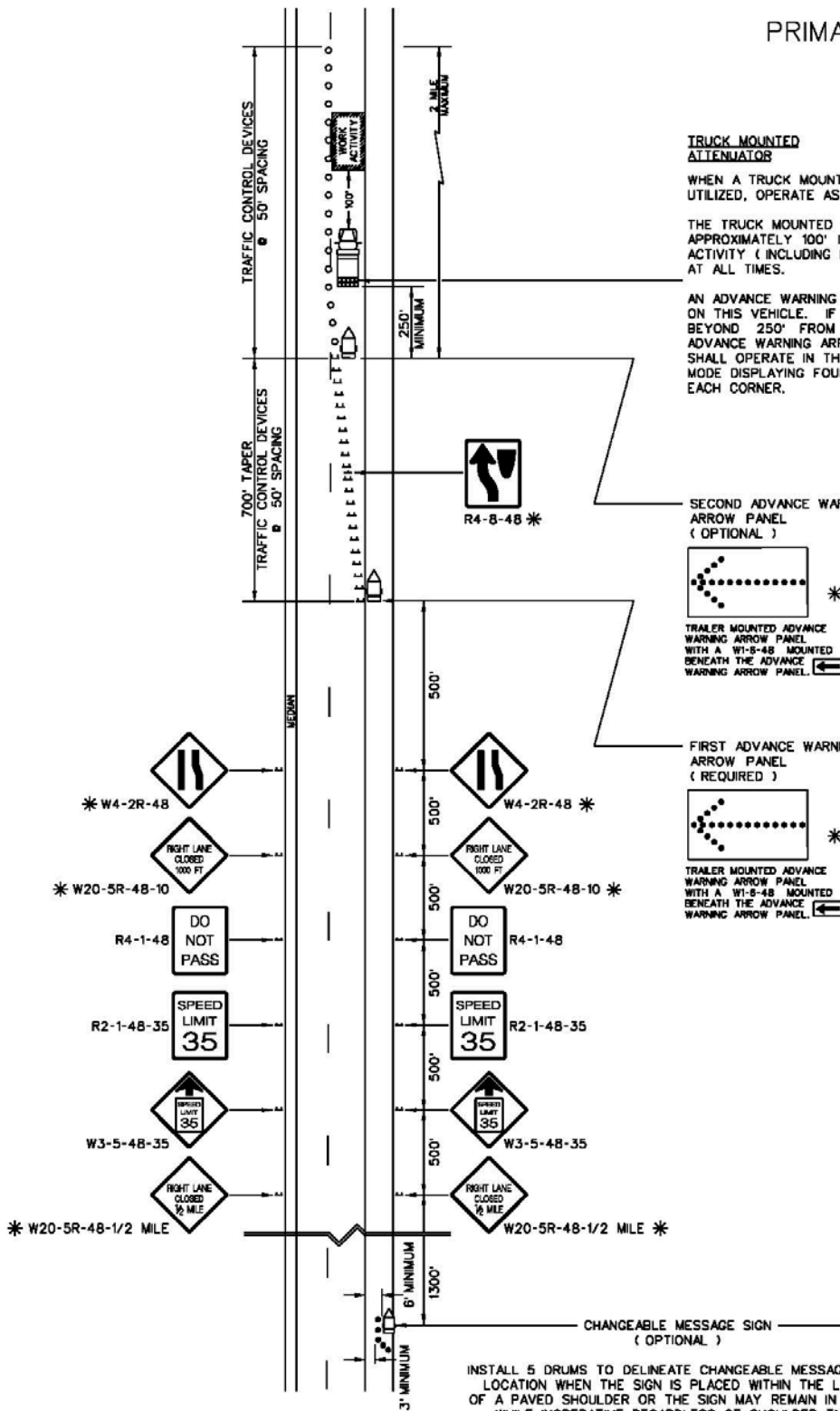

TRUCK MOUNTED ATTENUATOR

WHEN A TRUCK MOUNTED ATTENUATOR IS UTILIZED, OPERATE AS FOLLOWS:

THE TRUCK MOUNTED ATTENUATOR SHALL REMAIN APPROXIMATELY 100' IN ADVANCE OF THE WORK ACTIVITY (INCLUDING PERSONNEL AND MACHINERY) AT ALL TIMES.

AN ADVANCE WARNING ARROW PANEL IS OPTIONAL ON THIS VEHICLE. IF THE VEHICLE IS ADVANCED BEYOND 250' FROM THE END OF THE TAPER, AN ADVANCE WARNING ARROW PANEL ON THIS VEHICLE SHALL OPERATE IN THE "FOUR CORNER" CAUTION MODE DISPLAYING FOUR LAMPS WITH ONE LAMP IN EACH CORNER.

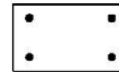

SECOND ADVANCE WARNING ARROW PANEL (OPTIONAL)

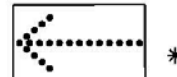

TRAILER MOUNTED ADVANCE WARNING ARROW PANEL WITH A W1-6-48 MOUNTED BENEATH THE ADVANCE WARNING ARROW PANEL.

FIRST ADVANCE WARNING ARROW PANEL (REQUIRED)

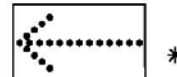

TRAILER MOUNTED ADVANCE WARNING ARROW PANEL WITH A W1-6-48 MOUNTED BENEATH THE ADVANCE WARNING ARROW PANEL.

*** LEFT LANE CLOSURE**

- 1.) SIGNS ILLUSTRATED ARE FOR A RIGHT LANE CLOSURE.
- 2.) WHEN CLOSING THE LEFT TRAVEL LANE, USE THE FOLLOWING:
 - 1 - R4-7-48
 - 2 - W4-2L-48
 - 2 - W20-5L-48-10
 - 2 - W20-5L-48-1/2 MILE
- 3.) THE FLASHING ARROWS AND W1-6-48 SIGNS SHALL POINT TO THE LEFT.



INSTALL 5 DRUMS TO DELINEATE CHANGEABLE MESSAGE SIGN LOCATION WHEN THE SIGN IS PLACED WITHIN THE LIMITS OF A PAVED SHOULDER OR THE SIGN MAY REMAIN IN PLACE WHILE INOPERATIVE REGARDLESS OF SHOULDER TYPE

WHEN CLOSING LEFT TRAVEL LANE, THE SIGN SHALL FLASH ALTERNATELY TO READ "LEFT LANE CLOSED", "MERGE RIGHT" AS NECESSARY.

**LANE CLOSURE
INTERMEDIATE SPEED TO HIGH SPEED
40 MPH - 60 MPH
EXIT / ENTRANCE RAMPS
MULTILANE PRIMARY & SECONDARY ROUTES**

1. Install the lane closure to provide no less than 500 feet between the downstream end of the taper area of the lane closure and the beginning of the opening for the access area to an exit ramp or an entrance ramp.
2. Install advance warning signs mounted on portable sign supports no less than 4 feet from the near edge of the sign to the near edge of an adjacent travel lane on roadways with grass shoulders and no less than 6 feet from the near edge of the sign to the near edge of an adjacent travel lane on roadways with paved shoulders. When a curb & gutter is present, install the sign no less than 2 feet from the near edge of the sign to the face of the curb.
3. On primary and secondary routes, the minimum mounting height of signs mounted on portable sign supports is 1 foot during this traffic control setup.
4. **In accordance with the requirements of the MUTCD, during lane closures on intermediate to high speed multilane primary and secondary routes with exit ramps, mount temporary "Exit" signs (E5-1) (M-1025) located within a temporary gore area at a minimum height of 7 feet from the pavement surface to the bottom edge of the sign.**
5. The advance warning sign placement intervals illustrated are for normal conditions. Adjustments to the distance intervals between the signs may be necessary due to sight distance restrictions such as curves and hills.
6. During daytime hours, 28" or 36" standard traffic cones may be utilized for delineation of the lane closure. The 28" and 36" standard traffic cones used during daytime hours are not required to be reflectorized.
7. During nighttime hours, portable plastic drums or 42" oversized traffic cones are required for delineation of the lane closure.
8. If a daytime work operation extends into the nighttime hours, replace the 28" or 36" standard traffic cones with portable plastic drums or 42" oversized traffic cones.
9. Reflectorize all portable plastic drums and 42" oversized traffic cones with Type III flexible microprismatic retroreflective sheeting.
10. When a truck mounted attenuator is used, maintain the truck mounted attenuator approximately 100 feet in advance of the work activities.
11. Conduct the work in such a manner to avoid encroaching into the adjacent travel lane open to traffic.

LANE CLOSURE LOCATION NOTE:

INSTALL THE LANE CLOSURE TO PROVIDE NO LESS THAN 500 FEET BETWEEN THE DOWNSTREAM END OF THE TAPER OF THE LANE CLOSURE AND THE BEGINNING OF AN OPENING FOR AN ACCESS TO AN ENTRANCE OR EXIT RAMP.

DRAWING 505-03-B
 LANE CLOSURE
 INTERMEDIATE SPEED TO HIGH SPEED
 40 MPH - 60 MPH
 EXIT / ENTRANCE RAMP
 PRIMARY & SECONDARY
 ROUTES

TRUCK MOUNTED
 ATTENUATOR

WHEN A TRUCK MOUNTED ATTENUATOR IS UTILIZED, OPERATE AS FOLLOWS:

THE TRUCK MOUNTED ATTENUATOR SHALL REMAIN APPROXIMATELY 100' IN ADVANCE OF THE WORK ACTIVITY (INCLUDING PERSONNEL AND MACHINERY) AT ALL TIMES.

AN ADVANCE WARNING ARROW PANEL IS OPTIONAL ON THIS VEHICLE. WHEN THIS VEHICLE IS LOCATED BEYOND AN EXIT RAMP, AN ADVANCE WARNING ARROW PANEL ON THIS VEHICLE SHALL OPERATE IN THE "FOUR CORNER" CAUTION MODE DISPLAYING FOUR LAMPS WITH ONE IN EACH CORNER.



EXIT PORTABLE EXIT SIGN (E5-1) (M-1025) (36" x 36")

MOUNT THE PORTABLE EXIT SIGN (E5-1) (M-1025) AT A MINIMUM MOUNTING HEIGHT OF 7' FROM THE BOTTOM OF THE SIGN TO THE PAVEMENT SURFACE

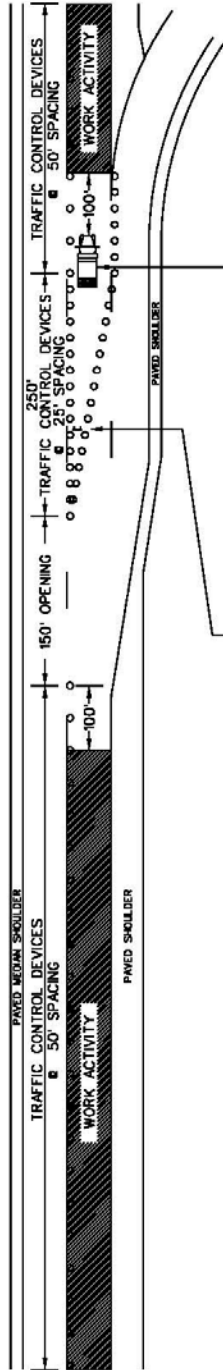

EXIT RAMP

TRUCK MOUNTED
 ATTENUATOR

WHEN A TRUCK MOUNTED ATTENUATOR IS UTILIZED, OPERATE AS FOLLOWS:

THE TRUCK MOUNTED ATTENUATOR SHALL REMAIN APPROXIMATELY 100' IN ADVANCE OF THE WORK ACTIVITY (INCLUDING PERSONNEL AND MACHINERY) AT ALL TIMES.

AN ADVANCE WARNING ARROW PANEL IS OPTIONAL ON THIS VEHICLE. WHEN THIS VEHICLE IS LOCATED BEYOND AN ENTRANCE RAMP, AN ADVANCE WARNING ARROW PANEL ON THIS VEHICLE SHALL OPERATE IN THE "FOUR CORNER" CAUTION MODE DISPLAYING FOUR LAMPS WITH ONE IN EACH CORNER.

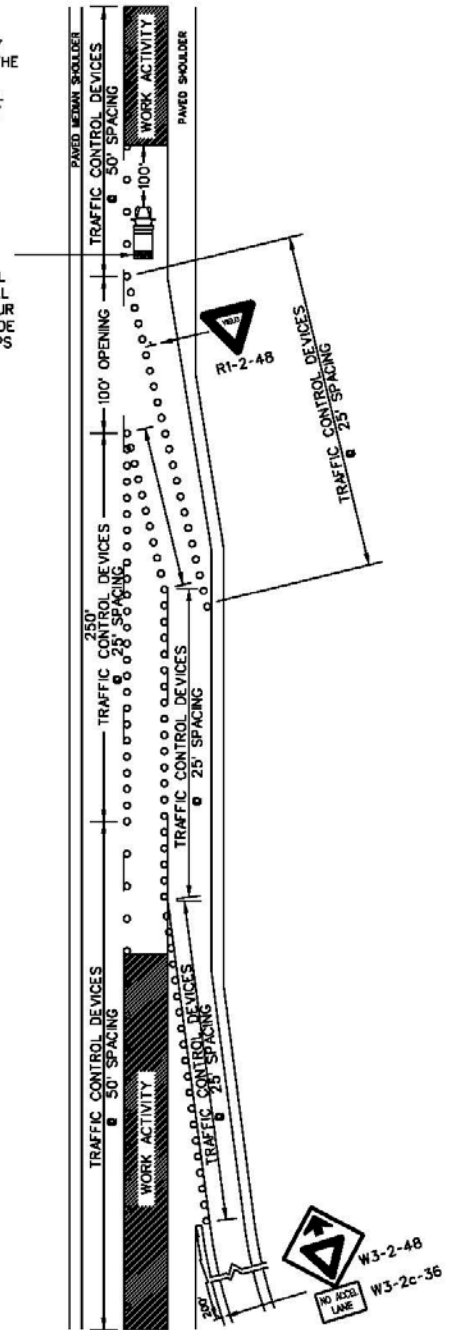
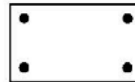

ENTRANCE RAMP

**DUAL LANE CLOSURE
INTERMEDIATE SPEED TO HIGH SPEED
40 MPH - 60 MPH
MULTILANE PRIMARY & SECONDARY ROUTES**

1. These lane closures are restricted to maximum distances of 2 miles unless otherwise directed by the District Engineering Administrator.
2. Measure all advance warning sign locations from the beginning of the taper.
3. Install advance warning signs mounted on portable sign supports no less than 4 feet from the near edge of the sign to the near edge of an adjacent travel lane on roadways with grass shoulders and no less than 6 feet from the near edge of the sign to the near edge of an adjacent travel lane on roadways with paved shoulders. When a curb & gutter is present, install the sign no less than 2 feet from the near edge of the sign to the face of the curb.
4. **During dual lane closures on intermediate to high speed multilane primary and secondary routes, the minimum mounting height of signs mounted on portable sign supports is 5 feet.**
5. **In accordance with the requirements of the MUTCD, during dual lane closures on intermediate to high speed multilane primary and secondary routes with exit ramps, mount temporary "Exit" signs (E5-1) (M-1025) located within a temporary gore area at a minimum height of 7 feet from the pavement surface to the bottom edge of the sign.**
6. The advance warning sign placement intervals illustrated are for normal conditions. Adjustments to the distance intervals between the signs may be necessary due to sight distance restrictions such as curves and hills.
7. Install and operate two trailer mounted advance warning arrow panels within each taper of a dual lane closure on intermediate to high speed primary and secondary roadways. Place one advance warning arrow panel at the beginning of each taper and a second advance warning arrow panel within the closure at the downstream end of each taper. However, where the shoulders are narrow or site conditions restrict the use of the shoulder areas adjacent to the beginning of the first taper of a dual lane closure, place the first advance warning arrow panel behind the channelizing devices of the first taper as close as practical to the beginning of the first taper. Placement of the first advance warning arrow panel at the start of the first taper of a dual lane closure is preferred.
8. Delineate dual lane closure with portable plastic drums or 42" oversized traffic cones. Delineation of dual lane closures with 28" or 36" standard traffic cones is PROHIBITED.
9. Reflectorize all portable plastic drums and 42" oversized traffic cones with Type III flexible microprismatic retroreflective sheeting.
10. If work is being conducted at two different locations at the same time in the same travel lane on an intermediate to high speed roadway, 40 to 60 MPH, separate the two locations by no less than 2 miles from the end of the first lane closure to the beginning of the initial taper of the second lane closure.
11. If work is being conducted at two different locations at the same time in different travel lanes on an intermediate to high speed roadway, 40 to 60 MPH, separate the two locations by no less than 4 miles from the end of the first lane closure to the beginning of the initial taper of the second lane closure.
12. When a truck mounted attenuator is used, maintain the truck mounted attenuator approximately 100 feet in advance of the work activities.
13. Conduct the work in such a manner to avoid encroaching into the adjacent travel lane open to traffic.

14. A trailer mounted changeable message sign is not required but is optional. When a trailer mounted changeable message sign is utilized, install the changeable message sign on the shoulder of the roadway no less than 6 feet from the near edge of the sign to the near edge of the adjacent travel lane when space is available. When the 6 foot space or right-of-way is unavailable, place the trailer mounted changeable message sign at the greatest possible distance up to 6 feet from the near edge of the adjacent travel lane. When a trailer mounted changeable message sign is placed within the limits of a paved shoulder or remains in place adjacent to a travel lane regardless of shoulder type when inoperative, supplement the trailer mounted changeable message sign location with no less than 5 portable plastic drums placed between the sign and the adjacent travel lane for delineation of the sign location. This requirement for delineation of the sign location applies at all times under the aforementioned conditions during which the sign is within 15 feet of the near edge of a travel lane open to traffic. Use of 28" or 36" standard traffic cones or 42" oversized traffic cones as substitutes for the portable plastic drums in this application is PROHIBITED. The sign shall flash alternately to read "LEFT TWO LANES CLOSED", "MERGE RIGHT" or "RIGHT TWO LANES CLOSED", "MERGE LEFT" as necessary. Also, the messages shall flash at a rate to permit motorists to read both messages at least once.

DRAWING 505-04-A
 DUAL LANE CLOSURE
 TRANSITION / ACTIVITY AREAS
 INTERMEDIATE SPEED TO HIGH SPEED
 40 MPH - 60 MPH
 MULTILANE
 PRIMARY & SECONDARY
 ROUTES

**TRUCK MOUNTED
 ATTENUATOR**

WHEN A TRUCK MOUNTED ATTENUATOR IS UTILIZED, OPERATE AS FOLLOWS:

THE TRUCK MOUNTED ATTENUATOR SHALL REMAIN APPROXIMATELY 100' IN ADVANCE OF THE WORK ACTIVITY (INCLUDING PERSONNEL AND MACHINERY) AT ALL TIMES.

AN ADVANCE WARNING ARROW PANEL IS OPTIONAL ON THIS VEHICLE. IF THE VEHICLE IS ADVANCED BEYOND 250' FROM THE END OF THE TAPER, AN ADVANCE WARNING ARROW PANEL ON THIS VEHICLE SHALL OPERATE IN THE "FOUR CORNER" CAUTION MODE DISPLAYING FOUR LAMPS WITH ONE LAMP IN EACH CORNER.

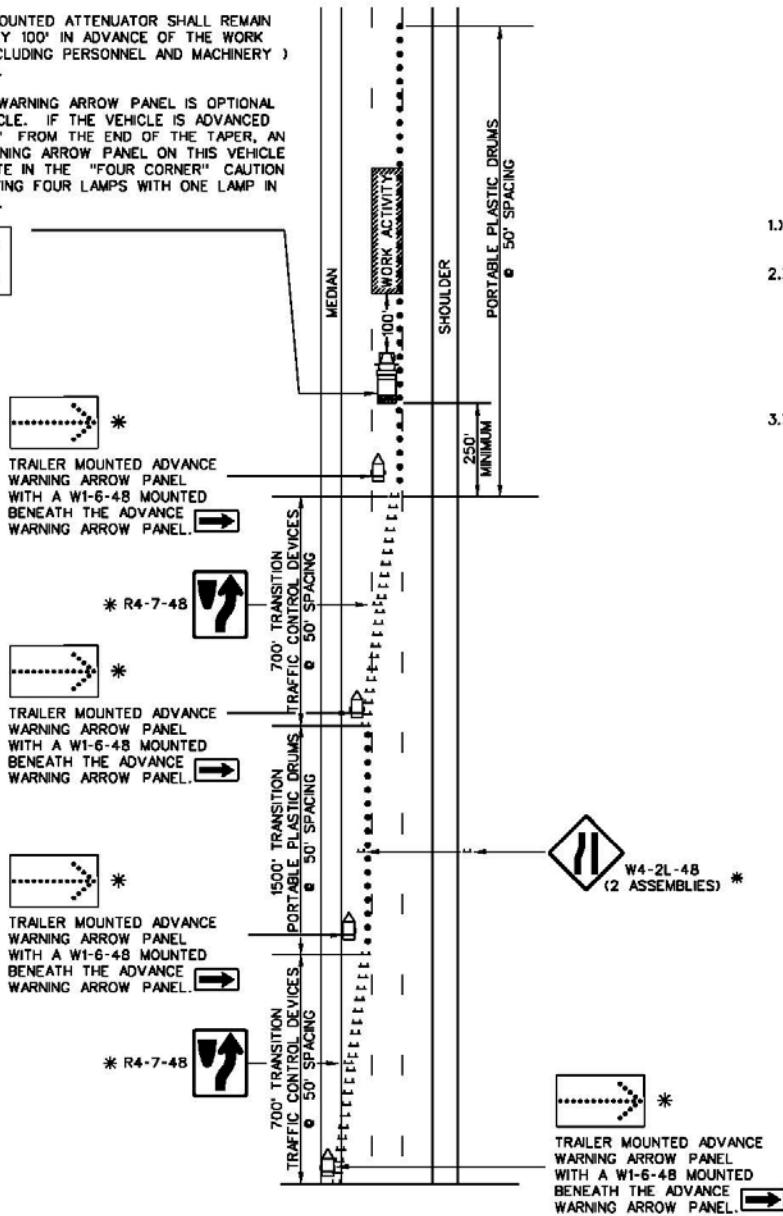
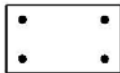

*** RIGHT LANE CLOSURE**

- 1.) SIGNS ILLUSTRATED ARE FOR CLOSURE OF THE LEFT TWO LANES.
- 2.) WHEN CLOSING THE RIGHT TWO LANES, USE THE FOLLOWING:
 - 2 - R4-B-4B
 - 4 - W4-2R-4B
 - 2 - W20-50R-4B-10
 - 2 - W20-50R-4B-1/2 MILE
 - 2 - W20-50R-4B-1 MILE
- 3.) THE FLASHING ARROWS AND W1-6-4B SIGNS SHALL POINT TO THE LEFT.

SPECIAL NOTE:

INSTALL ALL SIGNS AT A MINIMUM 5 FOOT MOUNTING HEIGHT FOR THIS TRAFFIC CONTROL SETUP.

DRAWING 505-04-B
 DUAL LANE CLOSURE
 ADVANCE WARNING AREA
 INTERMEDIATE SPEED TO HIGH SPEED
 40 MPH - 60 MPH
 MULTILANE
 PRIMARY & SECONDARY
 ROUTES

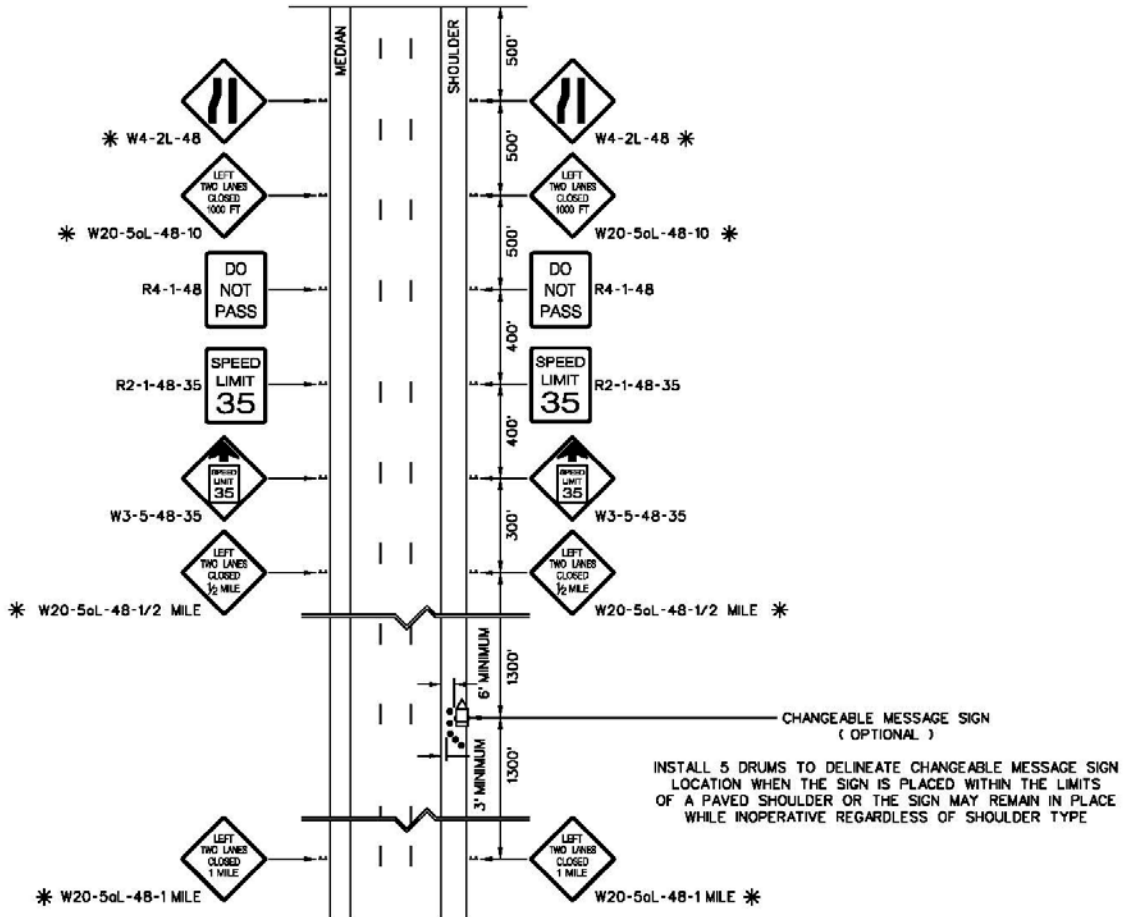

CHANGEABLE MESSAGE SIGN
 (OPTIONAL)

INSTALL 5 DRUMS TO DELINEATE CHANGEABLE MESSAGE SIGN LOCATION WHEN THE SIGN IS PLACED WITHIN THE LIMITS OF A PAVED SHOULDER OR THE SIGN MAY REMAIN IN PLACE WHILE INOPERATIVE REGARDLESS OF SHOULDER TYPE

*** RIGHT LANE CLOSURE**

- 1.) SIGNS ILLUSTRATED ARE FOR CLOSURE OF THE LEFT TWO LANES.
- 2.) WHEN CLOSING THE RIGHT TWO LANES, USE THE FOLLOWING:
 - 2 - R4-B-48
 - 4 - W4-2R-48
 - 2 - W20-5oR-48-10
 - 2 - W20-5oR-48-1/2 MILE
 - 2 - W20-5oR-48-1 MILE
- 3.) THE FLASHING ARROWS AND W1-6-48 SIGNS SHALL POINT TO THE LEFT.

SPECIAL NOTE:

INSTALL ALL SIGNS AT A MINIMUM 5 FOOT MOUNTING HEIGHT FOR THIS TRAFFIC CONTROL SETUP.

**DUAL LANE CLOSURE
INTERMEDIATE SPEED TO HIGH SPEED
40 MPH - 60 MPH
EXIT / ENTRANCE RAMPS
MULTILANE PRIMARY & SECONDARY ROUTES**

1. Install the lane closure to provide no less than 500 feet between the downstream end of the taper area of the lane closure and the beginning of the opening for the access area to an exit ramp or an entrance ramp.
2. Install advance warning signs mounted on portable sign supports no less than 4 feet from the near edge of the sign to the near edge of an adjacent travel lane on roadways with grass shoulders and no less than 6 feet from the near edge of the sign to the near edge of an adjacent travel lane on roadways with paved shoulders. When a curb & gutter is present, install the sign no less than 2 feet from the near edge of the sign to the face of the curb.
3. On primary and secondary routes, the minimum mounting height of signs mounted on portable sign supports is 1 foot during this traffic control setup.
4. **In accordance with the requirements of the MUTCD, during dual lane closures on intermediate to high speed multilane primary and secondary routes with exit ramps, mount temporary "Exit" signs (E5-1) (M-1025) located within a temporary gore area at a minimum height of 7 feet from the pavement surface to the bottom edge of the sign.**
5. The advance warning sign placement intervals illustrated are for normal conditions. Adjustments to the distance intervals between the signs may be necessary due to sight distance restrictions such as curves and hills.
6. Delineate dual lane closure with portable plastic drums or 42" oversized traffic cones. Delineation of dual lane closures with 36" standard traffic cones is PROHIBITED.
7. Reflectorize all portable plastic drums and 42" oversized traffic cones with Type III flexible microprismatic retroreflective sheeting.
8. When a truck mounted attenuator is used, maintain the truck mounted attenuator approximately 100 feet in advance of the work activities.
9. Conduct the work in such a manner to avoid encroaching into the adjacent travel lane open to traffic.

LANE CLOSURE LOCATION NOTE:

INSTALL THE LANE CLOSURE TO PROVIDE NO LESS THAN 500 FEET BETWEEN THE DOWNSTREAM END OF THE TAPER OF THE LANE CLOSURE AND THE BEGINNING OF AN OPENING FOR AN ACCESS TO AN ENTRANCE OR EXIT RAMP.

**DRAWING 505-04-C
DUAL LANE CLOSURE
INTERMEDIATE SPEED TO HIGH SPEED
40 MPH - 60 MPH
EXIT / ENTRANCE RAMPS
PRIMARY & SECONDARY
ROUTES**

**TRUCK MOUNTED
ATTENUATOR**

WHEN A TRUCK MOUNTED ATTENUATOR IS UTILIZED, OPERATE AS FOLLOWS:

THE TRUCK MOUNTED ATTENUATOR SHALL REMAIN APPROXIMATELY 100' IN ADVANCE OF THE WORK ACTIVITY (INCLUDING PERSONNEL AND MACHINERY) AT ALL TIMES.

AN ADVANCE WARNING ARROW PANEL IS OPTIONAL ON THIS VEHICLE. WHEN THIS VEHICLE IS LOCATED BEYOND AN EXIT RAMP, AN ADVANCE WARNING ARROW PANEL ON THIS VEHICLE SHALL OPERATE IN THE "FOUR CORNER" CAUTION MODE DISPLAYING FOUR LAMPS WITH ONE IN EACH CORNER.

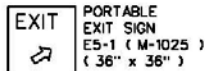

PORTABLE EXIT SIGN E5-1 (M-1025) (36" x 36")

MOUNT THE PORTABLE EXIT SIGN (E5-1) (M-1025) AT A MINIMUM MOUNTING HEIGHT OF 7' FROM THE BOTTOM OF THE SIGN TO THE PAVEMENT SURFACE.

**TRUCK MOUNTED
ATTENUATOR**

WHEN A TRUCK MOUNTED ATTENUATOR IS UTILIZED, OPERATE AS FOLLOWS:

THE TRUCK MOUNTED ATTENUATOR SHALL REMAIN APPROXIMATELY 100' IN ADVANCE OF THE WORK ACTIVITY (INCLUDING PERSONNEL AND MACHINERY) AT ALL TIMES.

AN ADVANCE WARNING ARROW PANEL IS OPTIONAL ON THIS VEHICLE. WHEN THIS VEHICLE IS LOCATED BEYOND AN ENTRANCE RAMP, AN ADVANCE WARNING ARROW PANEL ON THIS VEHICLE SHALL OPERATE IN THE "FOUR CORNER" CAUTION MODE DISPLAYING FOUR LAMPS WITH ONE IN EACH CORNER.

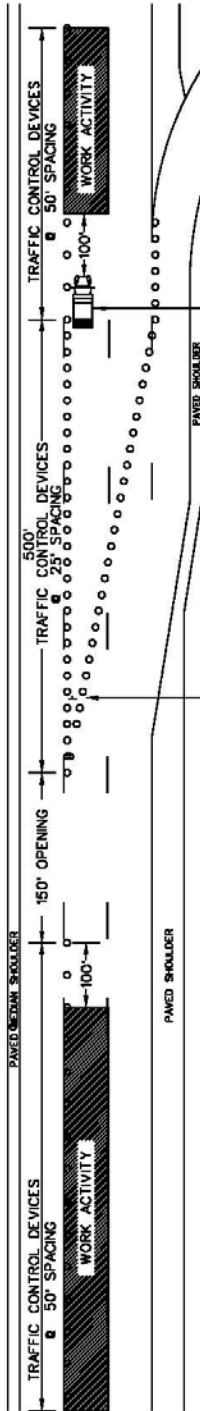
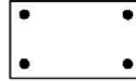

EXIT RAMP

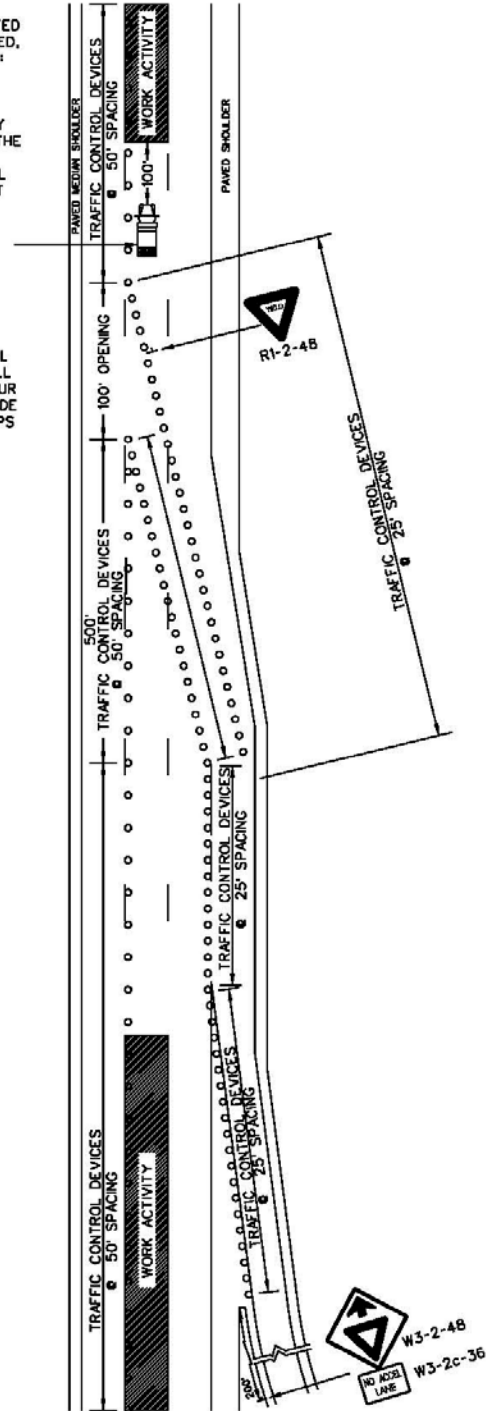

ENTRANCE RAMP

LANE CLOSURES

***INTERSTATE
ROUTES***

STANDARD DRAWING NO. 510-01-A

Through

STANDARD DRAWING NO. 510-02-C

**LANE CLOSURE
INTERSTATE ROUTES**

1. These lane closures are restricted to maximum distances of 2 miles unless otherwise directed by the District Engineering Administrator.
2. Measure all advance warning sign locations from the beginning of the taper.
3. Install advance warning signs mounted on portable sign supports no less than 4 feet from the near edge of the sign to the near edge of an adjacent travel lane on roadways with grass shoulders and no less than 6 feet from the near edge of the sign to the near edge of an adjacent travel lane on roadways with paved shoulders. When a curb & gutter is present, install the sign no less than 2 feet from the near edge of the sign to the face of the curb.
4. **On interstate routes, the minimum mounting height of the advance warning signs mounted on portable sign supports is 5 feet from the ground to the bottom edge of the sign.**
5. **In accordance with the requirements of the MUTCD, mount temporary "Exit" signs (E5-1) (M-1025) located within a temporary gore area during lane closures on interstate routes at a minimum height of 7 feet from the pavement surface to the bottom edge of the sign.**
6. The advance warning sign placement intervals illustrated are for normal conditions. Adjustments to the distance intervals between the signs may be necessary due to sight distance restrictions such as curves and hills.
7. Install and operate two trailer mounted advance warning arrow panels within the taper of a single lane closure on interstate roadways. Place one advance warning arrow panel on the roadway shoulder at the beginning of the taper and a second within the closure at the downstream end of the taper.
8. During daytime hours, 36" standard traffic cones may be utilized for delineation of the lane closure. The 36" standard traffic cones used during daytime hours are not required to be reflectorized.
9. During nighttime hours, portable plastic drums or 42" oversized traffic cones are required for delineation of the lane closure.
10. If a daytime work operation extends into the nighttime hours, replace the 36" standard traffic cones with portable plastic drums or 42" oversized traffic cones.
11. Reflectorize all portable plastic drums and 42" oversized traffic cones with Type III flexible microprismatic retroreflective sheeting.
12. If work is being conducted at two different locations at the same time in the same travel lane, separate the two locations by no less than 2 miles from the end of the first lane closure to the beginning of the taper of the second lane closure.
13. If work is being conducted at two different locations at the same time in different travel lanes, separate the two locations by no less than 4 miles from the end of the first lane closure to the beginning of the taper of the second lane closure.
14. When a truck mounted attenuator is used, maintain the truck mounted attenuator approximately 100 feet in advance of the work activities.
15. Conduct the work in such a manner to avoid encroaching into the adjacent travel lane open to traffic.
16. A trailer mounted changeable message sign is not required but is optional. When a trailer mounted changeable message sign is utilized, install the changeable message sign on the shoulder of the roadway no less than 6 feet from the near edge of the sign to the near edge of the adjacent travel lane. Supplement the trailer mounted changeable message sign location with no less than 5 portable plastic drums placed between the sign and the adjacent travel lane for delineation of the sign location. Install and maintain the drums not closer than 3 feet from the near edge of the adjacent travel lane. The requirement for delineation of the sign location applies at all times during which the sign is within 30 feet of the near edge of a travel lane open to traffic. Use of 28" or 36" standard traffic cones or 42" oversized traffic cones as substitutes for the portable plastic drums in this application is PROHIBITED. The sign shall flash alternately to read "RIGHT LANE CLOSED", "MERGE LEFT" or "LEFT LANE CLOSED", "MERGE RIGHT" as necessary. Also, the messages shall flash at a rate to permit motorists to read both messages at least once.

17. When a traffic queue develops, provide a truck with a truck mounted changeable message sign or a static sign to convey advance notice to motorists that the motorists are approaching a traffic queue and should be prepared to stop. Place this truck on the shoulder of the roadway and maintain the truck no less than 2000 feet in advance of the traffic queue at all times. Placement of this truck on the shoulder of the roadway without an operator is PROHIBITED. A truck mounted changeable message sign shall display the message, "PREPARE TO STOP", with a minimum character height of 18 inches and comply with all SCDOT specifications. If utilizing the static sign, the static sign shall be a 48-inch x 48-inch "Be Prepared To Stop" sign (W3-4-48) with a rigid sign reflectorized with either Type VIII, Type IX or Type XI microprismatic fluorescent orange retroreflective sheeting with a sign legend composed of 8 inch black Series "C" letters. Supplement the static sign with two amber high intensity rotating, flashing, oscillating or strobe lights.

DRAWING 510-01-A LANE CLOSURE INTERSTATE ROUTES

TRUCK MOUNTED ATTENUATOR

WHEN A TRUCK MOUNTED ATTENUATOR IS UTILIZED, OPERATE AS FOLLOWS:

THE TRUCK MOUNTED ATTENUATOR SHALL REMAIN APPROXIMATELY 100' IN ADVANCE OF THE WORK ACTIVITY (INCLUDING PERSONNEL AND MACHINERY) AT ALL TIMES.

AN ADVANCE WARNING ARROW PANEL IS OPTIONAL ON THIS VEHICLE. IF THE VEHICLE IS ADVANCED BEYOND 250' FROM THE END OF THE TAPER, AN ADVANCE WARNING ARROW PANEL ON THIS VEHICLE SHALL OPERATE IN THE "FOUR CORNER" CAUTION MODE DISPLAYING FOUR LAMPS WITH ONE LAMP IN EACH CORNER.

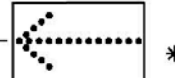
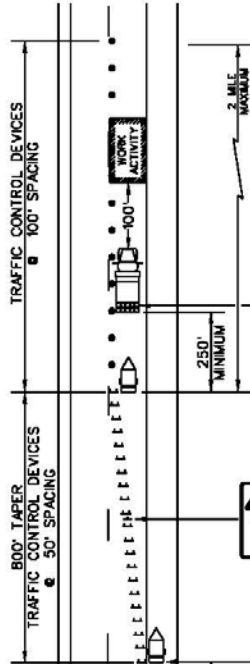
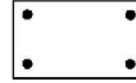

TRAILER MOUNTED ADVANCE WARNING ARROW PANEL WITH A W1-6-48 MOUNTED BENEATH THE ADVANCE WARNING ARROW PANEL.

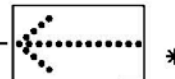

TRAILER MOUNTED ADVANCE WARNING ARROW PANEL WITH A W1-6-48 MOUNTED BENEATH THE ADVANCE WARNING ARROW PANEL.

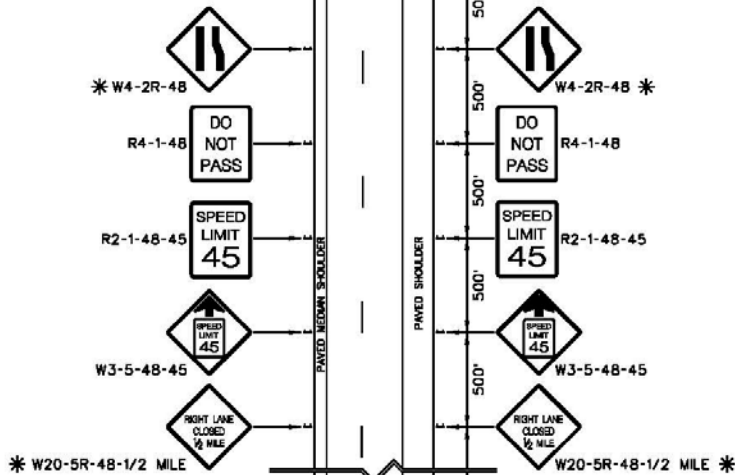

* LEFT LANE CLOSURE

- 1.) SIGNS ILLUSTRATED ARE FOR A RIGHT LANE CLOSURE.
- 2.) WHEN CLOSING THE LEFT TRAVEL LANE, USE THE FOLLOWING:
 - 1 - R4-7-4B
 - 2 - W4-2L-4B
 - 2 - W20-5L-4B-1/2 MILE
 - 2 - W20-5L-4B-1 MILE
- 3.) THE FLASHING ARROWS AND W1-6-4B SIGNS SHALL POINT TO THE LEFT.

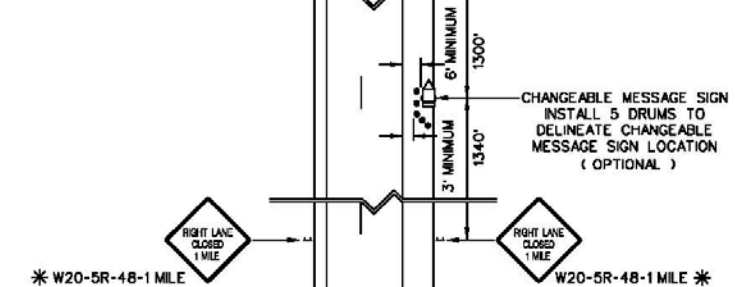

WHEN CLOSING LEFT TRAVEL LANE, THE SIGN SHALL FLASH ALTERNATELY TO READ "LEFT LANE CLOSED", "MERGE RIGHT" AS NECESSARY.



TRUCK MOUNTED CHANGEABLE MESSAGE SIGN

MAINTAIN MINIMUM DISTANCE OF 2000 FEET IN ADVANCE OF THE TRAFFIC QUEUE AT ALL TIMES



TRUCK MOUNTED STATIC SIGN

SPECIAL NOTE:
INSTALL ALL SIGNS AT A MINIMUM 5 FOOT MOUNTING HEIGHT FOR THIS TRAFFIC CONTROL SETUP.

**LANE CLOSURE
EXIT / ENTRANCE RAMPS
INTERSTATE ROUTES**

1. Install the lane closure to provide no less than 500 feet between the downstream end of the taper area of the lane closure and the beginning of the opening for the access area to an exit ramp or an entrance ramp.
2. Install advance warning signs mounted on portable sign supports no less than 4 feet from the near edge of the sign to the near edge of an adjacent travel lane on roadways with grass shoulders and no less than 6 feet from the near edge of the sign to the near edge of an adjacent travel lane on roadways with paved shoulders. When a curb & gutter is present, install the sign no less than 2 feet from the near edge of the sign to the face of the curb.
3. **On interstate routes, the minimum mounting height of the advance warning signs mounted on portable sign supports is 5 feet from the ground to the bottom edge of the sign.**
4. **In accordance with the requirements of the MUTCD, mount temporary "Exit" signs (E5-1) (M-1025) located within a temporary gore area during lane closures on interstate routes at a minimum height of 7 feet from the pavement surface to the bottom edge of the sign.**
5. The advance warning sign placement intervals illustrated are for normal conditions. Adjustments to the distance intervals between the signs may be necessary due to sight distance restrictions such as curves and hills.
6. During daytime hours, 36" standard traffic cones may be utilized for delineation of the lane closure. The 36" standard traffic cones used during daytime hours are not required to be reflectorized.
7. During nighttime hours, portable plastic drums or 42" oversized traffic cones are required for delineation of the lane closure.
8. If a daytime work operation extends into the nighttime hours, replace the 36" standard traffic cones with portable plastic drums or 42" oversized cones.
9. Reflectorize all portable plastic drums and 42" oversized traffic cones with Type III flexible microprismatic retroreflective sheeting.
10. When a truck mounted attenuator is used, maintain the truck mounted attenuator approximately 100 feet in advance of the work activities.
11. Conduct the work in such a manner to avoid encroaching into the adjacent travel lane open to traffic.

DRAWING 510-01-B
LANE CLOSURE
EXIT / ENTRANCE RAMP
INTERSTATE ROUTES

LANE CLOSURE LOCATION NOTE:

INSTALL THE LANE CLOSURE TO PROVIDE NO LESS THAN 500 FEET BETWEEN THE DOWNSTREAM END OF THE TAPER OF THE LANE CLOSURE AND THE BEGINNING OF AN OPENING FOR AN ACCESS TO AN ENTRANCE OR EXIT RAMP.

TRUCK MOUNTED ATTENUATOR

WHEN A TRUCK MOUNTED ATTENUATOR IS UTILIZED, OPERATE AS FOLLOWS:

THE TRUCK MOUNTED ATTENUATOR SHALL REMAIN APPROXIMATELY 100' IN ADVANCE OF THE WORK ACTIVITY (INCLUDING PERSONNEL AND MACHINERY) AT ALL TIMES.

AN ADVANCE WARNING ARROW PANEL IS OPTIONAL ON THIS VEHICLE. WHEN THIS VEHICLE IS LOCATED BEYOND AN EXIT RAMP, AN ADVANCE WARNING ARROW PANEL ON THIS VEHICLE SHALL OPERATE IN THE "FOUR CORNER" CAUTION MODE DISPLAYING FOUR LAMPS WITH ONE IN EACH CORNER.

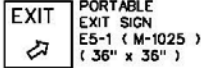

MOUNT THE PORTABLE EXIT SIGN (E5-1) (M-1025) AT A MINIMUM MOUNTING HEIGHT OF 7' FROM THE BOTTOM OF THE SIGN TO THE PAVEMENT SURFACE

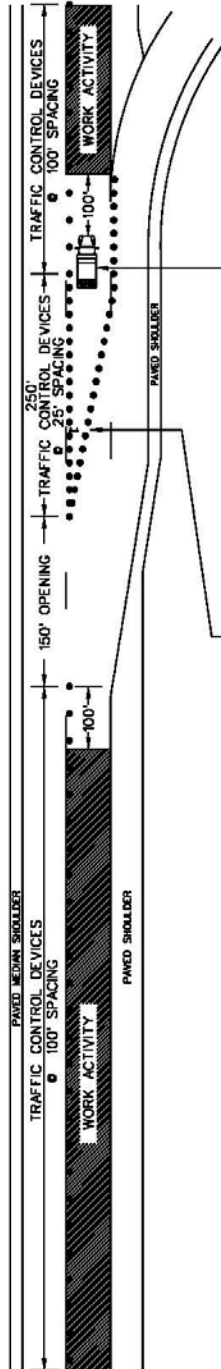

EXIT RAMP

TRUCK MOUNTED ATTENUATOR

WHEN A TRUCK MOUNTED ATTENUATOR IS UTILIZED, OPERATE AS FOLLOWS:

THE TRUCK MOUNTED ATTENUATOR SHALL REMAIN APPROXIMATELY 100' IN ADVANCE OF THE WORK ACTIVITY (INCLUDING PERSONNEL AND MACHINERY) AT ALL TIMES.

AN ADVANCE WARNING ARROW PANEL IS OPTIONAL ON THIS VEHICLE. WHEN THIS VEHICLE IS LOCATED BEYOND AN ENTRANCE RAMP, AN ADVANCE WARNING ARROW PANEL ON THIS VEHICLE SHALL OPERATE IN THE "FOUR CORNER" CAUTION MODE DISPLAYING FOUR LAMPS WITH ONE IN EACH CORNER.

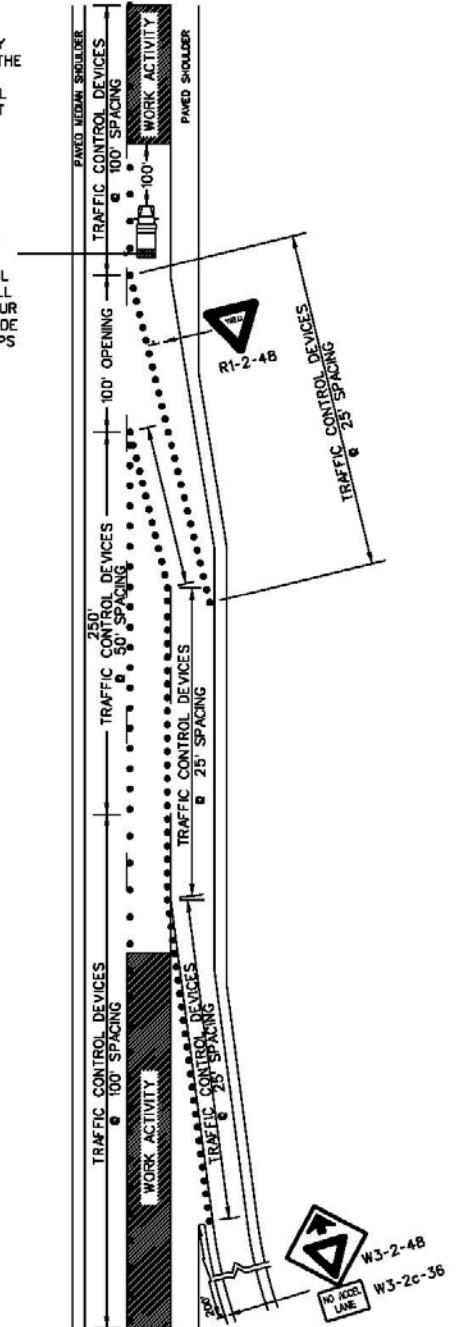
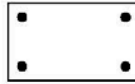

ENTRANCE RAMP

**Drawing Nos. 510-02-A
510-02-B**

**DUAL LANE CLOSURE
INTERSTATE ROUTES**

1. These lane closures are restricted to maximum distances of 2 miles unless otherwise directed by the District Engineering Administrator.
2. Measure all advance warning sign locations from the beginning of the taper.
3. Install advance warning signs mounted on portable sign supports no less than 4 feet from the near edge of the sign to the near edge of an adjacent travel lane on roadways with grass shoulders and no less than 6 feet from the near edge of the sign to the near edge of an adjacent travel lane on roadways with paved shoulders. When a curb & gutter is present, install the sign no less than 2 feet from the near edge of the sign to the face of the curb.
4. **On interstate routes, the minimum mounting height of the advance warning signs mounted on portable sign supports is 5 feet from the ground to the bottom edge of the sign.**
5. **In accordance with the requirements of the MUTCD, mount temporary "Exit" signs (E5-1) (M-1025) located within a temporary gore area during lane closures on interstate routes at a minimum height of 7 feet from the pavement surface to the bottom edge of the sign.**
6. The advance warning sign placement intervals illustrated are for normal conditions. Adjustments to the distance intervals between the signs may be necessary due to sight distance restrictions such as curves and hills.
7. Install and operate two trailer mounted advance warning arrow panels within each taper of a dual lane closure on interstate roadways. Place one advance warning arrow panel at the beginning of each taper and a second advance warning arrow panel within the closure at the downstream end of each taper.
8. Delineate dual lane closure with portable plastic drums or 42" oversized traffic cones. Delineation of dual lane closures with 36" standard traffic cones is PROHIBITED.
9. Reflectorize all portable plastic drums and 42" oversized traffic cones with Type III flexible microprismatic retroreflective sheeting.
10. If work is being conducted at two different locations at the same time in the same travel lane, separate the two locations by no less than 2 miles from the end of the first lane closure to the beginning of the initial taper of the second lane closure.
11. If work is being conducted at two different locations at the same time in different travel lanes, separate the two locations by no less than 4 miles from the end of the first lane closure to the beginning of the initial taper of the second lane closure.
12. When a truck mounted attenuator is used, maintain the truck mounted attenuator approximately 100 feet in advance of the work activities.
13. Conduct the work in such a manner to avoid encroaching into the adjacent travel lane open to traffic.
14. A trailer mounted changeable message sign is not required but is optional. When a trailer mounted changeable message sign is utilized, install the changeable message sign on the shoulder of the roadway no less than 6 feet from the near edge of the sign to the near edge of the adjacent travel lane. Supplement the trailer mounted changeable message sign location with no less than 5 portable plastic drums placed between the sign and the adjacent travel lane for delineation of the sign location. Install and maintain the drums not closer than 3 feet from the near edge of the adjacent travel lane. The requirement for delineation of the sign location applies at all times during which the sign is within 30 feet of the near edge of a travel lane open to traffic. Use of 28" or 36" standard traffic cones or 42" oversized traffic cones as substitutes for the portable plastic drums in this application is PROHIBITED. The sign shall flash alternately to read "LEFT TWO LANES CLOSED", "MERGE RIGHT" or "RIGHT TWO LANES CLOSED", "MERGE LEFT" as necessary. Also, the messages shall flash at a rate to permit motorists to read both messages at least once.

15. When a traffic queue develops, provide a truck with a truck mounted changeable message sign or a static sign to convey advance notice to motorists that the motorists are approaching a traffic queue and should be prepared to stop. Place this truck on the shoulder of the roadway and maintain the truck no less than 2000 feet in advance of the traffic queue at all times. Placement of this truck on the shoulder of the roadway without an operator is PROHIBITED. A truck mounted changeable message sign shall display the message, "PREPARE TO STOP", with a minimum character height of 18 inches and comply with all SCDOT specifications. If utilizing the static sign, the static sign shall be a 48-inch x 48-inch "Be Prepared To Stop" sign (W3-4-48) with a rigid sign substrate reflectorized with either Type VIII, Type IX or Type XI microprismatic fluorescent orange retroreflective sheeting with a sign legend composed of 8 inch black Series "C" letters. Supplement the static sign with two amber high intensity rotating, flashing, oscillating or strobe lights.

DRAWING 510-02-A DUAL LANE CLOSURE TRANSITION / ACTIVITY AREAS INTERSTATE ROUTES

**TRUCK MOUNTED
ATTENUATOR**

WHEN A TRUCK MOUNTED ATTENUATOR IS UTILIZED, OPERATE AS FOLLOWS:

THE TRUCK MOUNTED ATTENUATOR SHALL REMAIN APPROXIMATELY 100' IN ADVANCE OF THE WORK ACTIVITY (INCLUDING PERSONNEL AND MACHINERY) AT ALL TIMES.

AN ADVANCE WARNING ARROW PANEL IS OPTIONAL ON THIS VEHICLE. IF THE VEHICLE IS ADVANCED BEYOND 250' FROM THE END OF THE TAPER, AN ADVANCE WARNING ARROW PANEL ON THIS VEHICLE SHALL OPERATE IN THE "FOUR CORNER" CAUTION MODE DISPLAYING FOUR LAMPS WITH ONE LAMP IN EACH CORNER.

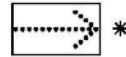
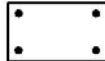

TRAILER MOUNTED ADVANCE WARNING ARROW PANEL WITH A W1-6-48 MOUNTED BENEATH THE ADVANCE WARNING ARROW PANEL.

* R4-7-48



TRAILER MOUNTED ADVANCE WARNING ARROW PANEL WITH A W1-6-48 MOUNTED BENEATH THE ADVANCE WARNING ARROW PANEL.

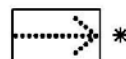

TRAILER MOUNTED ADVANCE WARNING ARROW PANEL WITH A W1-6-48 MOUNTED BENEATH THE ADVANCE WARNING ARROW PANEL.

* R4-7-48

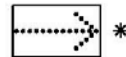

TRAILER MOUNTED ADVANCE WARNING ARROW PANEL WITH A W1-6-48 MOUNTED BENEATH THE ADVANCE WARNING ARROW PANEL.



W4-2L-48 (2 ASSEMBLIES) *

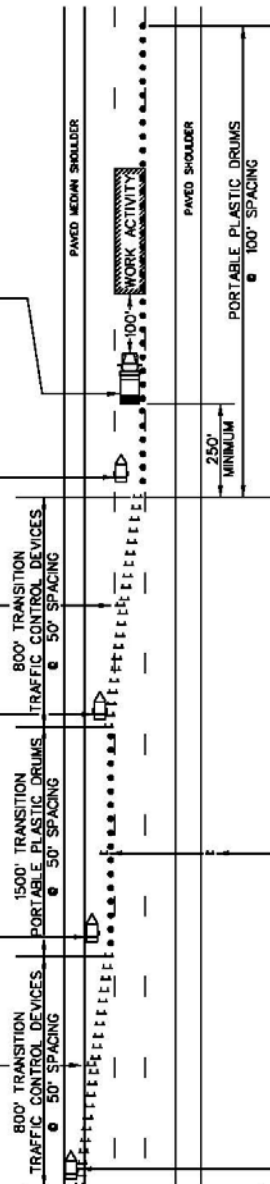

*** RIGHT LANE CLOSURE**

- 1.) SIGNS ILLUSTRATED ARE FOR CLOSURE OF THE LEFT TWO LANES.
- 2.) WHEN CLOSING THE RIGHT TWO LANES, USE THE FOLLOWING:
 - 2 - R4-B-48
 - 4 - W4-2R-48
 - 2 - W20-50R-48-1/2 MILE
 - 2 - W20-50R-48-1 MILE
 - 2 - W20-50R-48-2 MILE
- 3.) THE FLASHING ARROWS AND W1-6-48 SIGNS SHALL POINT TO THE LEFT.

SPECIAL NOTE:

INSTALL ALL SIGNS AT A MINIMUM 5 FOOT MOUNTING HEIGHT FOR THIS TRAFFIC CONTROL SETUP.

*** RIGHT LANE CLOSURE**

- 1.) SIGNS ILLUSTRATED ARE FOR CLOSURE OF THE LEFT TWO LANES.
- 2.) WHEN CLOSING THE RIGHT TWO LANES, USE THE FOLLOWING:
 - 2 - R4-8-48
 - 4 - W4-2R-48
 - 2 - W20-50R-48-1/2 MILE
 - 2 - W20-50R-48-1 MILE
 - 2 - W20-50R-48-2 MILE
- 3.) THE FLASHING ARROWS AND W1-6-48 SIGNS SHALL POINT TO THE LEFT.

**DRAWING 510-02-B
DUAL LANE CLOSURE
ADVANCE WARNING AREA
INTERSTATE ROUTES**

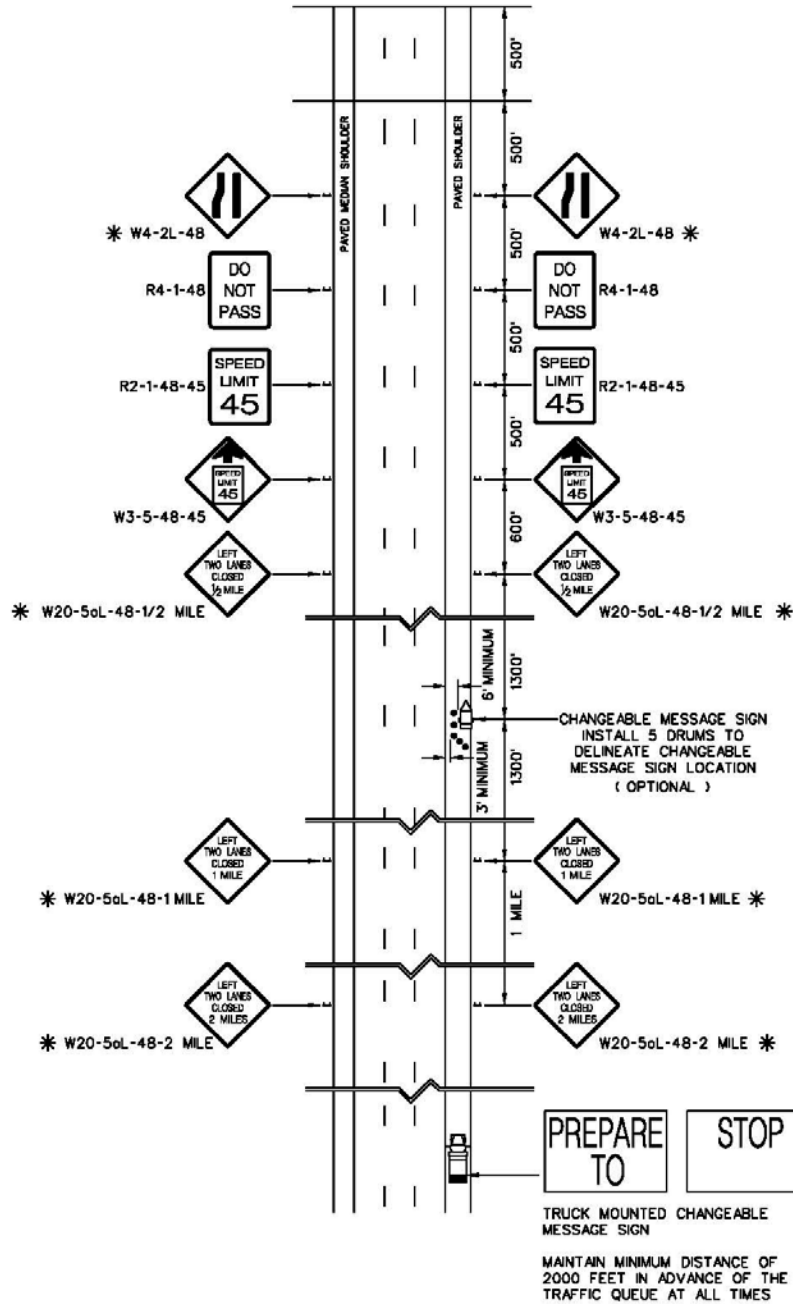

SPECIAL NOTE:
INSTALL ALL SIGNS AT A MINIMUM 5 FOOT MOUNTING HEIGHT FOR THIS TRAFFIC CONTROL SETUP.

**DUAL LANE CLOSURE
EXIT / ENTRANCE RAMPS
INTERSTATE ROUTES**

1. Install the lane closure to provide no less than 500 feet between the downstream end of the taper area of the lane closure and the beginning of the opening for the access area to an exit ramp or an entrance ramp.
2. Install advance warning signs mounted on portable sign supports no less than 4 feet from the near edge of the sign to the near edge of an adjacent travel lane on roadways with grass shoulders and no less than 6 feet from the near edge of the sign to the near edge of an adjacent travel lane on roadways with paved shoulders. When a curb & gutter is present, install the sign no less than 2 feet from the near edge of the sign to the face of the curb.
3. **On interstate routes, the minimum mounting height of the advance warning signs mounted on portable sign supports is 5 feet from the ground to the bottom edge of the sign.**
4. **In accordance with the requirements of the MUTCD, mount temporary "Exit" signs (E5-1) (M-1025) located within a temporary gore area during lane closures on interstate routes at a minimum height of 7 feet from the pavement surface to the bottom edge of the sign.**
5. The advance warning sign placement intervals illustrated are for normal conditions. Adjustments to the distance intervals between the signs may be necessary due to sight distance restrictions such as curves and hills.
6. Delineate dual lane closure with portable plastic drums or 42" oversized traffic cones. Delineation of dual lane closures with 36" standard traffic cones is PROHIBITED.
7. Reflectorize all portable plastic drums and 42" oversized traffic cones with Type III flexible microprismatic retroreflective sheeting.
8. When a truck mounted attenuator is used, maintain the truck mounted attenuator approximately 100 feet in advance of the work activities.
9. Conduct the work in such a manner to avoid encroaching into the adjacent travel lane open to traffic.

LANE CLOSURE LOCATION NOTE:

INSTALL THE LANE CLOSURE TO PROVIDE NO LESS THAN 500 FEET BETWEEN THE DOWNSTREAM END OF THE TAPER OF THE LANE CLOSURE AND THE BEGINNING OF AN OPENING FOR AN ACCESS TO AN ENTRANCE OR EXIT RAMP.

**DRAWING 510-02-C
DUAL LANE CLOSURE
EXIT / ENTRANCE RAMPS
INTERSTATE ROUTES**

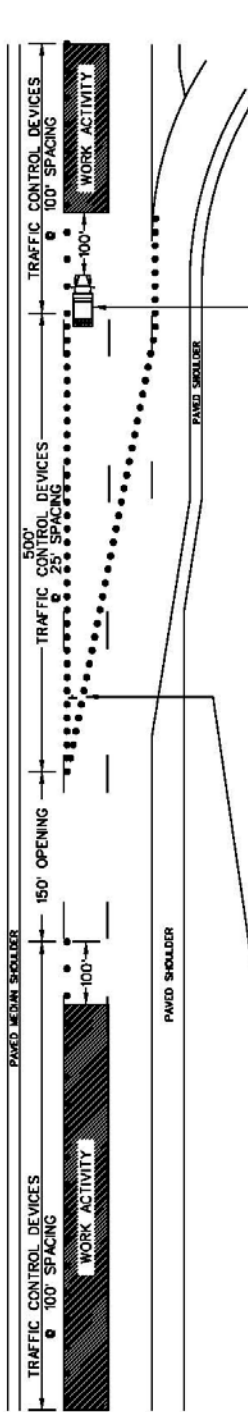

EXIT RAMP

TRUCK MOUNTED ATTENUATOR

WHEN A TRUCK MOUNTED ATTENUATOR IS UTILIZED, OPERATE AS FOLLOWS:

THE TRUCK MOUNTED ATTENUATOR SHALL REMAIN APPROXIMATELY 100' IN ADVANCE OF THE WORK ACTIVITY (INCLUDING PERSONNEL AND MACHINERY) AT ALL TIMES.

AN ADVANCE WARNING ARROW PANEL IS OPTIONAL ON THIS VEHICLE. WHEN THIS VEHICLE IS LOCATED BEYOND AN EXIT RAMP, AN ADVANCE WARNING ARROW PANEL ON THIS VEHICLE SHALL OPERATE IN THE "FOUR CORNER" CAUTION MODE DISPLAYING FOUR LAMPS WITH ONE IN EACH CORNER.

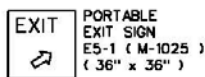
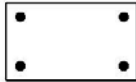

PORTABLE EXIT SIGN
E5-1 (M-1025)
(36" x 36")

MOUNT THE PORTABLE EXIT SIGN (E5-1) (M-1025) AT A MINIMUM MOUNTING HEIGHT OF 7' FROM THE BOTTOM OF THE SIGN TO THE PAVEMENT SURFACE.

TRUCK MOUNTED ATTENUATOR

WHEN A TRUCK MOUNTED ATTENUATOR IS UTILIZED, OPERATE AS FOLLOWS:

THE TRUCK MOUNTED ATTENUATOR SHALL REMAIN APPROXIMATELY 100' IN ADVANCE OF THE WORK ACTIVITY (INCLUDING PERSONNEL AND MACHINERY) AT ALL TIMES.

AN ADVANCE WARNING ARROW PANEL IS OPTIONAL ON THIS VEHICLE. WHEN THIS VEHICLE IS LOCATED BEYOND AN ENTRANCE RAMP, AN ADVANCE WARNING ARROW PANEL ON THIS VEHICLE SHALL OPERATE IN THE "FOUR CORNER" CAUTION MODE DISPLAYING FOUR LAMPS WITH ONE IN EACH CORNER.

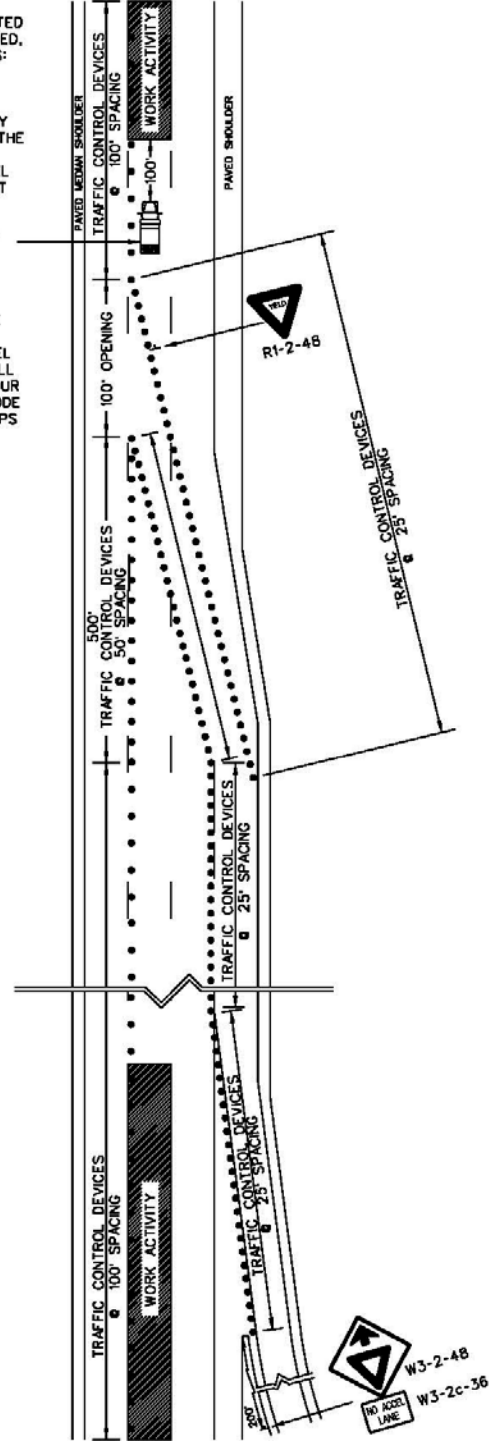
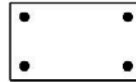

ENTRANCE RAMP

SHOULDER CLOSURES

**PRIMARY
&
SECONDARY
ROUTES**

STANDARD DRAWING NO. 515-01-A

Through

STANDARD DRAWING NO. 515-03

**RIGHT SHOULDER CLOSURE
(CASE I / CASE II)
TWO-LANE TWO-WAY ROADWAY
PRIMARY & SECONDARY ROUTES**

1. Install all advance warning signs as illustrated.
2. Install advance warning signs mounted on portable sign supports no less than 4 feet from the near edge of the sign to the near edge of an adjacent travel lane on roadways with grass shoulders and no less than 6 feet from the near edge of the sign to the near edge of an adjacent travel lane on roadways with paved shoulders. When a curb & gutter is present, install the sign no less than 2 feet from the near edge of the sign to the face of the curb.
3. On primary and secondary routes, the minimum mounting height of signs mounted on portable sign supports is 1 foot from the ground to the bottom edge of the sign during this traffic control setup.
4. The advance warning sign placement intervals illustrated are for normal conditions. Adjustments to the distance intervals between the signs may be necessary due to sight distance restrictions such as curves and hills.
5. During daytime hours, 28" or 36" standard traffic cones or 42" oversized traffic cones may be utilized for delineation of a shoulder closure. Standard traffic cones, 28" or 36" traffic cones, used during daytime hours are not required to be reflectorized. Delineation of a shoulder closure during nighttime hours with 28" or 36" standard traffic cones or 42" oversized traffic cones is PROHIBITED.
6. During nighttime hours, portable plastic drums are required for delineation of a shoulder closure.
7. If a daytime shoulder closure must be maintained into the nighttime hours, replace the 28" or 36" standard traffic cones or 42" oversized traffic cones with portable plastic drums.
8. Reflectorize all portable plastic drums and 42" oversized traffic cones with Type III flexible microprismatic retroreflective sheeting.
9. On primary and secondary roadways, install shoulder closures as follows:
 - CASE I: Install advance warning signs and traffic control devices to provide a 250 foot taper in advance of the closed shoulder area and to delineate the closed shoulder area when a work zone occupies the shoulder area within 15 feet but not closer than 1 foot from the near edge of the adjacent travel lane. A truck mounted attenuator is optional. An advance warning arrow panel is optional on the truck mounted attenuator. When an advance warning arrow panel is used, the advance warning arrow panel shall operate in the "Four Corner" caution mode displaying four lamps with one lamp in each corner.
 - CASE II: Only advance warning signs are required to be installed whenever a short term stationary or longer term work zone occupies any portion of the shoulder area beyond 15 feet but within 30 feet of the near edge of the adjacent travel lane.
10. When a truck mounted attenuator is used, maintain the truck mounted attenuator approximately 100 feet in advance of the work activities. Maintain a minimum distance of 1 foot or greater between the truck mounted attenuator and the near edge of the adjacent travel lane.
11. Conduct the work in such a manner to avoid encroaching within 1 foot of the near edge of the adjacent travel lane. If the work activities cannot be performed under this traffic control setup without encroaching within 1 foot of the near edge of the adjacent travel lane, close the adjacent travel lane to traffic and conduct flagging operations.
12. If work is being conducted at two different locations at the same time, separate the two locations by no less than 1 mile from the end of the first shoulder closure to the beginning of the taper of the second shoulder closure.
13. This traffic control setup for a right shoulder closure applies to closures of the right shoulder areas of secondary and primary routes.

DRAWING 515-01-A
 RIGHT SHOULDER CLOSURE
 (CASE I / CASE II)
 TWO-LANE TWO-WAY ROADWAY
 PRIMARY & SECONDARY
 ROUTES

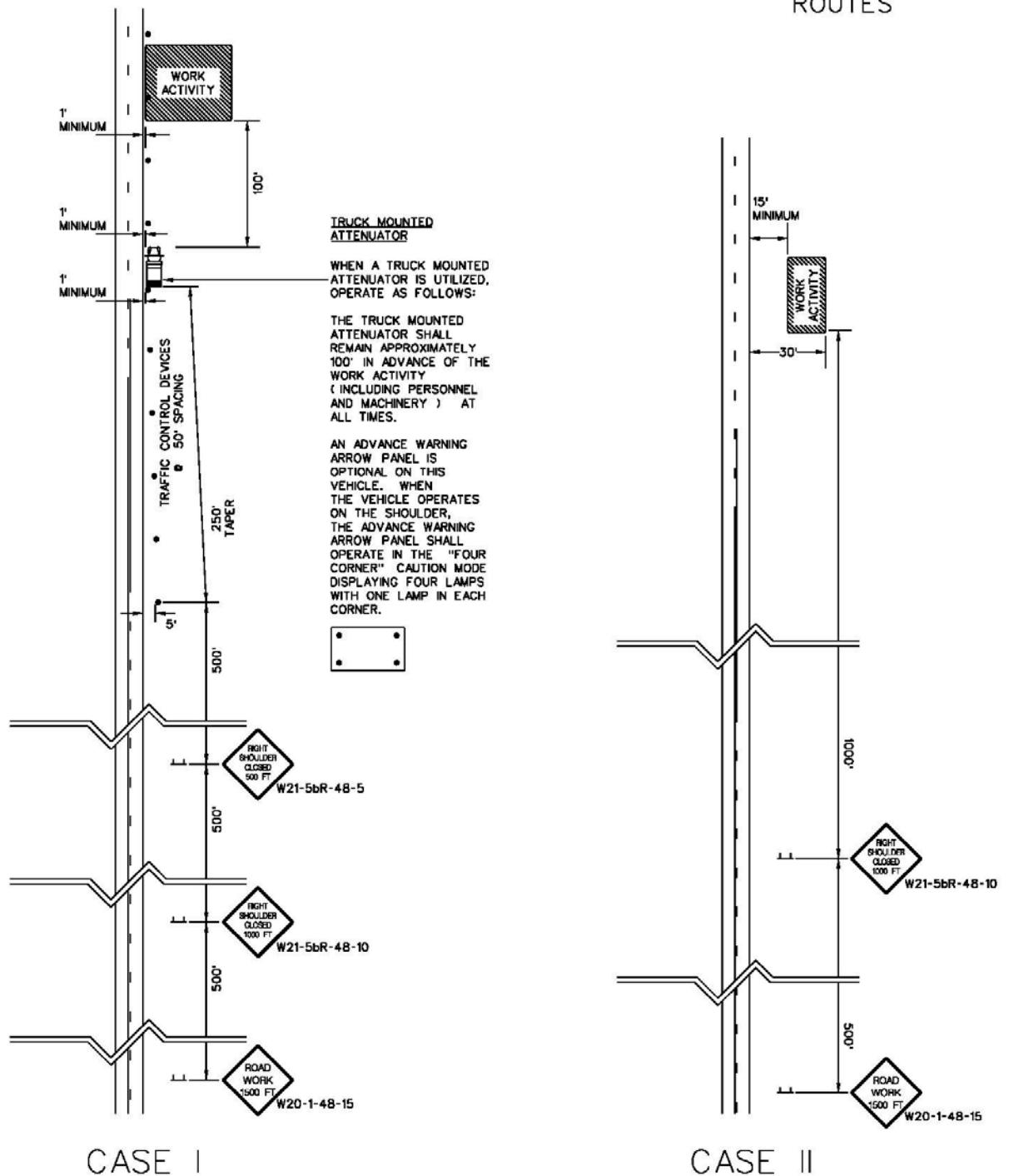

NOTE :

INSTALL TRAFFIC CONTROL DEVICES AT 50' SPACING AND SIGNS AS ILLUSTRATED. TRAFFIC CONTROL DEVICES SHOULD EXTEND NO LESS THAN 50' BEYOND THE WORK AREA.

**RIGHT SHOULDER CLOSURE
(CASE I / CASE II)
MULTILANE
PRIMARY & SECONDARY ROUTES**

1. Install all advance warning signs as illustrated.
2. Install advance warning signs mounted on portable sign supports no less than 4 feet from the near edge of the sign to the near edge of an adjacent travel lane on roadways with grass shoulders and no less than 6 feet from the near edge of the sign to the near edge of an adjacent travel lane on roadways with paved shoulders. When a curb & gutter is present, install the sign no less than 2 feet from the near edge of the sign to the face of the curb.
3. On primary and secondary routes, the minimum mounting height of signs mounted on portable sign supports is 1 foot from the ground to the bottom edge of the sign during this traffic control setup.
4. The advance warning sign placement intervals illustrated are for normal conditions. Adjustments to the distance intervals between the signs may be necessary due to sight distance restrictions such as curves and hills.
5. During daytime hours, 28" or 36" standard traffic cones or 42" oversized traffic cones may be utilized for delineation of the shoulder closure. Standard traffic cones, 28" or 36" traffic cones, used during daytime hours are not required to be reflectorized. Delineation of a shoulder closure during nighttime hours with 28" or 36" standard traffic cones or 42" oversized traffic cones is PROHIBITED.
6. During nighttime hours, portable plastic drums are required for delineation of a shoulder closure.
7. If a daytime shoulder closure must be maintained into the nighttime hours, replace the 28" or 36" standard traffic cones or 42" oversized traffic cones with portable plastic drums.
8. Reflectorize all portable plastic drums and 42" oversized traffic cones with Type III flexible microprismatic retroreflective sheeting.
9. On primary and secondary roadways, install shoulder closures as follows:
 - CASE I: Install advance warning signs and traffic control devices to provide a 250 foot taper in advance of the closed shoulder area and to delineate the closed shoulder area when a work zone occupies the shoulder area within 15 feet but not closer than 1 foot from the near edge of the adjacent travel lane. On high speed high volume multilane primary and secondary routes, a truck mounted attenuator supplemented with a truck mounted advance warning arrow panel is required; the truck mounted attenuator is optional on all other primary and secondary routes. The advance warning arrow panel shall operate in a flashing arrow mode when pedestrian workers are present within 15 feet of the near edge of the adjacent travel lane; when pedestrian workers are not present operate the advance warning arrow panel in the "Four Corner" caution mode.
 - CASE II: Only advance warning signs are required to be installed whenever a short term stationary or longer term work zone occupies any portion of the shoulder area beyond 15 feet but within 30 feet of the near edge of the adjacent travel lane.
10. When a truck mounted attenuator is used, maintain the truck mounted attenuator approximately 100 feet in advance of the work activities. Maintain a minimum distance of 1 foot or greater between the truck mounted attenuator and the near edge of the adjacent travel lane.
11. Conduct the work in such a manner to avoid encroaching within 1 foot of the near edge of the adjacent travel lane. If the work activities cannot be performed under this traffic control setup without encroaching within 1 foot of the near edge of the adjacent travel lane, close the adjacent travel lane to traffic.
12. If work is being conducted at two different locations at the same time, separate the two locations by no less than 1 mile from the end of the first shoulder closure to the beginning of the taper of the second shoulder closure.
13. This traffic control setup for a right shoulder closure applies to closures of the right shoulder areas of secondary and primary routes.

DRAWING 515-01-B
 RIGHT SHOULDER CLOSURE
 (CASE I / CASE II)
 MULTILANE
 PRIMARY & SECONDARY
 ROUTES

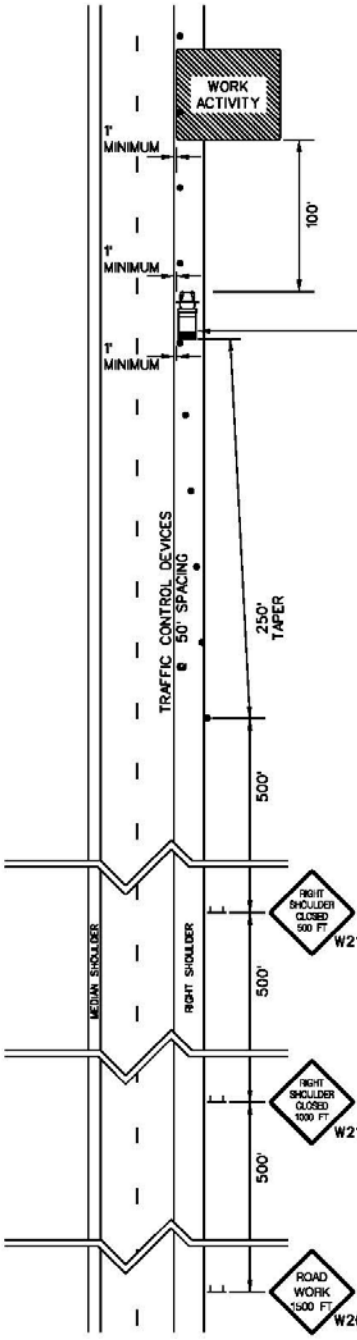

CASE I

TRUCK MOUNTED ATTENUATOR

WHEN A TRUCK MOUNTED ATTENUATOR IS UTILIZED, OPERATE AS FOLLOWS:

THE TRUCK MOUNTED ATTENUATOR SHALL REMAIN APPROXIMATELY 100' IN ADVANCE OF THE WORK ACTIVITY (INCLUDING PERSONNEL AND MACHINERY) AT ALL TIMES.

ON HIGH SPEED HIGH VOLUME MULTILANE PRIMARY & SECONDARY ROADWAYS, THE TRUCK MOUNTED ATTENUATOR SUPPLEMENTED WITH AN ADVANCE WARNING ARROW PANEL IS REQUIRED, THE TRUCK MOUNTED ATTENUATOR IS OPTIONAL ON ALL OTHER PRIMARY & SECONDARY ROADWAYS.

THE ADVANCE WARNING ARROW PANEL SHALL OPERATE IN THE "FOUR CORNER" CAUTION MODE WHEN PEDESTRIAN WORKERS ARE NOT PRESENT.



WHEN PEDESTRIAN WORKERS ARE PRESENT WITHIN 15 FEET OF THE NEAR EDGE OF THE ADJACENT TRAVEL LANE, OPERATE THE ADVANCE WARNING ARROW PANEL IN A FLASHING ARROW MODE AS ILLUSTRATED.

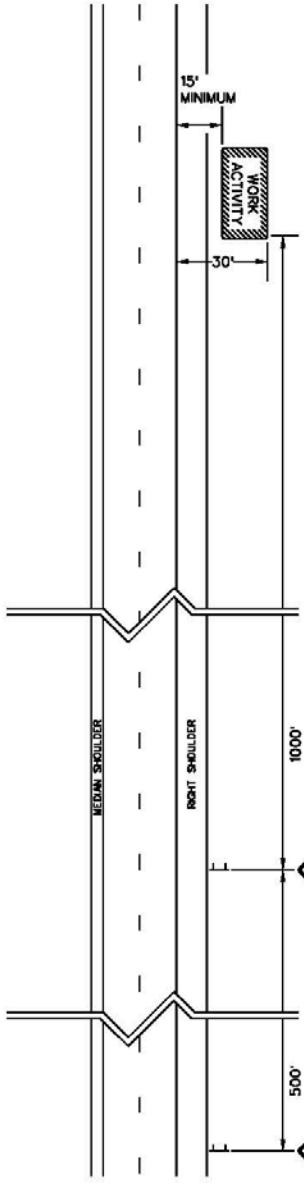

CASE II

TRUCK MOUNTED ATTENUATOR

WHEN A TRUCK MOUNTED ATTENUATOR IS UTILIZED, OPERATE AS FOLLOWS:

THE TRUCK MOUNTED ATTENUATOR SHALL REMAIN APPROXIMATELY 100' IN ADVANCE OF THE WORK ACTIVITY (INCLUDING PERSONNEL AND MACHINERY) AT ALL TIMES.

DURING THIS TRAFFIC CONTROL SETUP, WHEN A TRUCK MOUNTED ATTENUATOR SUPPLEMENTED WITH AN ADVANCE WARNING ARROW PANEL IS UTILIZED, OPERATE THE ADVANCE WARNING ARROW PANEL IN THE "FOUR CORNER" CAUTION MODE DISPLAYING FOUR LAMPS WITH ONE IN EACH CORNER.

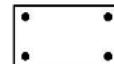

NOTE :
 INSTALL TRAFFIC CONTROL DEVICES AT 50' SPACING AND SIGNS AS ILLUSTRATED. TRAFFIC CONTROL DEVICES SHOULD EXTEND NO LESS THAN 50' BEYOND THE WORK AREA.

**RIGHT SHOULDER CLOSURE
LOW SPEED
< / = 35 MPH
PRIMARY & SECONDARY ROUTES
(MINOR ENCROACHMENT)**

1. On primary and secondary roadways, install shoulder closures with minor encroachment as follows:

On low speed roadways, speeds of 35 mph or less, shoulder closures are acceptable for work activities conducted within 30 feet of the near edge of an adjacent travel lane that require the presence of personnel, tools, equipment, materials, vehicles, etc. that may encroach upon the roadway to the extent that the adjacent travel lane is narrowed to a lane width no less than 10 feet through the installation of traffic control devices such as traffic cones or portable plastic drums.

2. Install all advance warning signs as illustrated.
3. Install advance warning signs mounted on portable sign supports no less than 4 feet from the near edge of the sign to the near edge of an adjacent travel lane on roadways with grass shoulders and no less than 6 feet from the near edge of the sign to the near edge of an adjacent travel lane on roadways with paved shoulders. When a curb & gutter is present, install the sign no less than 2 feet from the near edge of the sign to the face of the curb.
4. On primary and secondary routes, the minimum mounting height of signs mounted on portable sign supports is 1 foot from the ground to the bottom edge of the sign during this traffic control setup.
5. The advance warning sign placement intervals illustrated are for normal conditions. Adjustments to the distance intervals between the signs may be necessary due to sight distance restrictions such as curves and hills.
6. During daytime hours, 28" or 36" standard traffic cones or 42" oversized traffic cones may be utilized for delineation of the shoulder closure. Standard traffic cones, 28" or 36" traffic cones, used during daytime hours are not required to be reflectorized. Delineation of a shoulder closure during nighttime hours with 28" or 36" standard traffic cones or 42" oversized traffic cones is PROHIBITED.
7. During nighttime hours, portable plastic drums are required for delineation of a shoulder closure.
8. If a daytime shoulder closure must be maintained into the nighttime hours, replace the 28" or 36" standard traffic cones or 42" oversized traffic cones with portable plastic drums.
9. Reflectorize all portable plastic drums and 42" oversized traffic cones with Type III flexible microprismatic retroreflective sheeting.
10. When a truck mounted attenuator is used, maintain the truck mounted attenuator approximately 100 feet in advance of the work activities.
An advance warning arrow panel is optional on the truck mounted attenuator. When used the advance warning arrow panel shall operate in a flashing arrow mode when pedestrian workers are present within 15 feet of the near edge of the adjacent travel lane; when pedestrian workers are not present operate the advance warning arrow panel in the "Four Corner" caution mode.
11. If work is being conducted at two different locations at the same time, separate the two locations by no less than 1 mile from the end of the first shoulder closure to the beginning of the taper of the second shoulder closure.
12. This traffic control setup for a right shoulder closure applies to closures of the right shoulder areas of secondary and primary routes for short duration work zones that involve road machinery which may encroach upon an adjacent travel lane and slowly progresses along the roadway.

DRAWING 515-01-C
 RIGHT SHOULDER CLOSURE
 LOW SPEED
 ≤ 35 MPH
 PRIMARY & SECONDARY ROUTES
 (MINOR ENCROACHMENT)

* - UTILIZE A SHADOW VEHICLE WHEN THE REQUIRED STOPPING SIGHT DISTANCE INTERVAL BETWEEN THE WORK VEHICLE OR MACHINERY AND AN APPROACHING MOTORIST IS UNAVAILABLE BASED UPON THE POSTED REGULATORY SPEED LIMIT OF THE WORK LOCATION.

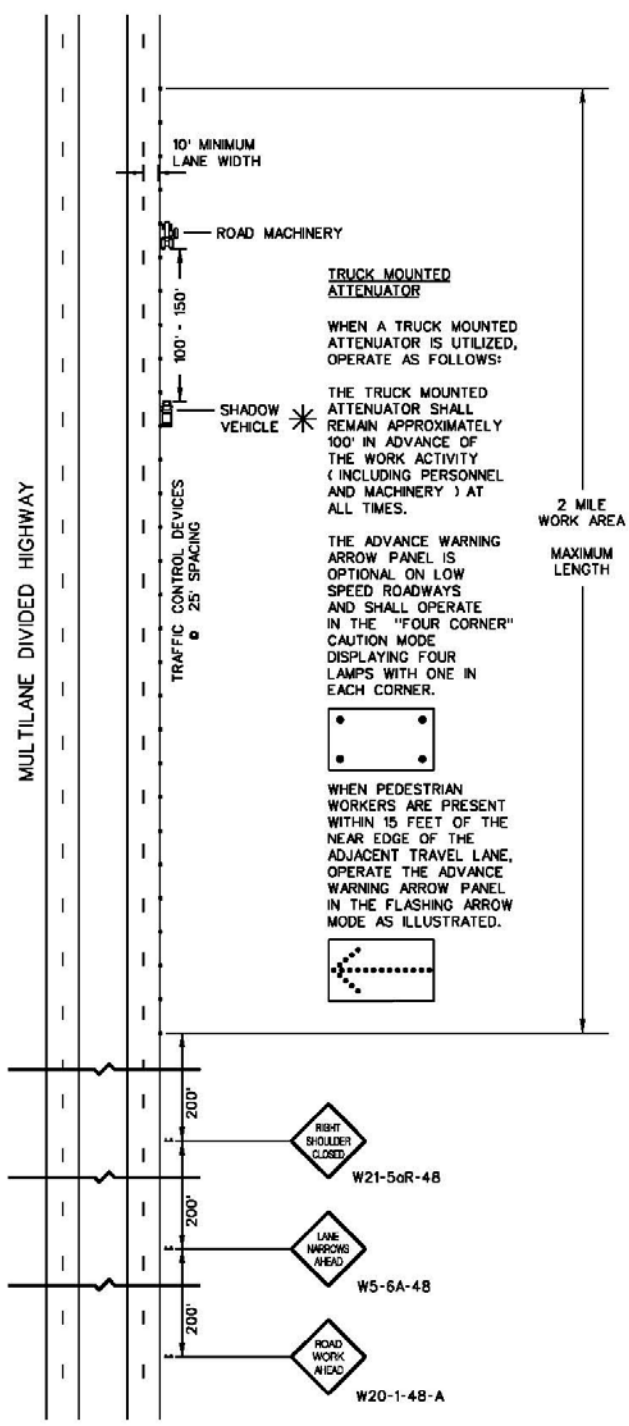
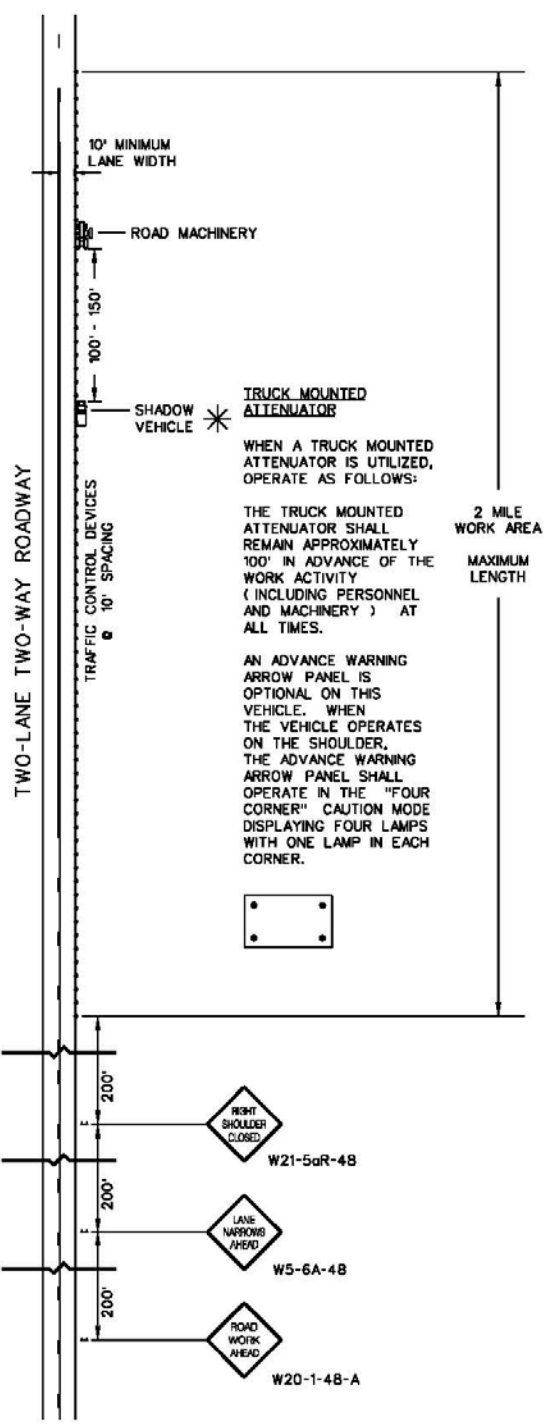

**LEFT SHOULDER CLOSURE
LOW SPEED
< / = 35 MPH
MULTILANE DIVIDED HIGHWAY
w/ GRASSED EARTH MEDIAN
PRIMARY & SECONDARY ROUTES
(MINOR ENCROACHMENT)**

1. On primary and secondary multilane roadways, install left shoulder closures with minor encroachment as follows:

On low speed roadways, speeds of 35 mph or less, shoulder closures are acceptable for work activities conducted within 30 feet of the near edge of an adjacent travel lane that require the presence of personnel, tools, equipment, materials, vehicles, etc. that may encroach upon the roadway to the extent that the adjacent travel lane is narrowed to a lane width no less than 10 feet through the installation of traffic control devices such as traffic cones or portable plastic drums.

2. Install all advance warning signs as illustrated.

3. Install advance warning signs mounted on portable sign supports no less than 4 feet from the near edge of the sign to the near edge of an adjacent travel lane on roadways with grass shoulders and no less than 6 feet from the near edge of the sign to the near edge of an adjacent travel lane on roadways with paved shoulders. When a curb & gutter is present, install the sign no less than 2 feet from the near edge of the sign to the face of the curb.

4. On primary and secondary routes, the minimum mounting height of signs mounted on portable sign supports is 1 foot from the ground to the bottom edge of the sign during this traffic control setup.

5. The advance warning sign placement intervals illustrated are for normal conditions. Adjustments to the distance intervals between the signs may be necessary due to sight distance restrictions such as curves and hills.

6. During daytime hours, 28" or 36" standard traffic cones or 42" oversized traffic cones may be utilized for delineation of the shoulder closure. Standard traffic cones, 28" or 36" traffic cones, used during daytime hours are not required to be reflectorized. Delineation of a shoulder closure during nighttime hours with 28" or 36" standard traffic cones or 42" oversized traffic cones is PROHIBITED.

7. During nighttime hours, portable plastic drums are required for delineation of a shoulder closure.

8. If a daytime shoulder closure must be maintained into the nighttime hours, replace the 28" or 36" standard traffic cones or 42" oversized traffic cones with portable plastic drums.

9. Reflectorize all portable plastic drums and 42" oversized traffic cones with Type III flexible microprismatic retroreflective sheeting.

10. When a truck mounted attenuator is used, maintain the truck mounted attenuator approximately 100 feet in advance of the work activities.

An advance warning arrow panel is optional on the truck mounted attenuator. When used the advance warning arrow panel shall operate in a flashing arrow mode when pedestrian workers are present within 15 feet of the near edge of the adjacent travel lane; when pedestrian workers are not present operate the advance warning arrow panel in the "Four Corner" caution mode.

11. If work is being conducted at two different locations at the same time, separate the two locations by no less than 1 mile from the end of the first shoulder closure to the beginning of the taper of the second shoulder closure.

12. This traffic control setup for a left shoulder closure applies to closures of the left shoulder areas of secondary and primary multilane divided routes with grassed earth shoulders for short duration work zones that involve road machinery which may encroach upon an adjacent travel lane and slowly progresses along the roadway.

DRAWING 515-01-D
 LEFT SHOULDER CLOSURE
 LOW SPEED
 ≤ 35 MPH
 MULTILANE DIVIDED HIGHWAY
 w/ GRASSED EARTH MEDIAN
 PRIMARY & SECONDARY
 ROUTES
 (MINOR ENCROACHMENT)

* - UTILIZE A SHADOW VEHICLE WHEN THE REQUIRED STOPPING SIGHT DISTANCE INTERVAL BETWEEN THE WORK VEHICLE OR MACHINERY AND AN APPROACHING MOTORIST IS UNAVAILABLE BASED UPON THE POSTED REGULATORY SPEED LIMIT OF THE WORK LOCATION.

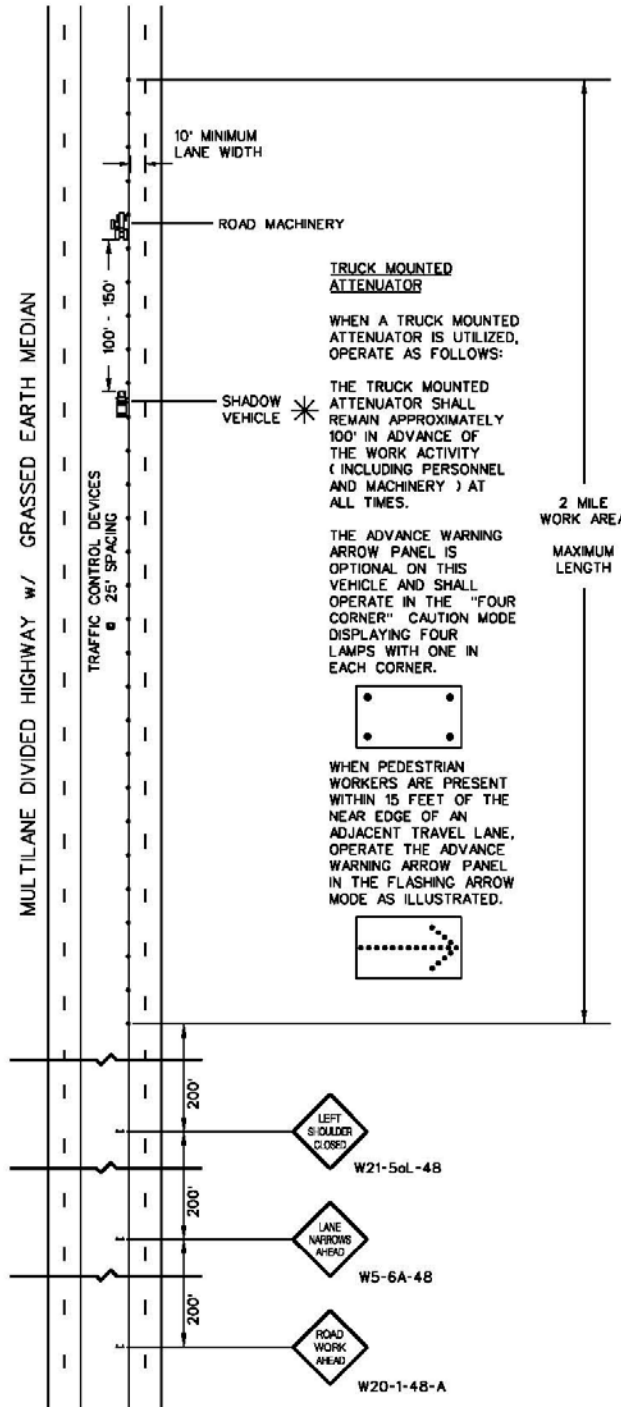

**LEFT SHOULDER CLOSURE
(CASE I / CASE I)
MULTILANE
PRIMARY & SECONDARY ROUTES**

1. Install all advance warning signs as illustrated.
2. Install advance warning signs mounted on portable sign supports no less than 4 feet from the near edge of the sign to the near edge of an adjacent travel lane on roadways with grass shoulders and no less than 6 feet from the near edge of the sign to the near edge of an adjacent travel lane on roadways with paved shoulders. When a curb & gutter is present, install the sign no less than 2 feet from the near edge of the sign to the face of the curb.
3. On primary and secondary routes, the minimum mounting height of signs mounted on portable sign supports is 1 foot from the ground to the bottom edge of the sign during this traffic control setup.
4. The advance warning sign placement intervals illustrated are for normal conditions. Adjustments to the distance intervals between the signs may be necessary due to sight distance restrictions such as curves and hills.
5. During daytime hours, 28" or 36" standard traffic cones or 42" oversized traffic cones may be utilized for delineation of the shoulder closure. Standard traffic cones, 28" or 36" traffic cones, used during daytime hours are not required to be reflectorized. Delineation of a shoulder closure during nighttime hours with 28" or 36" standard traffic cones or 42" oversized traffic cones is PROHIBITED.
6. During nighttime hours, portable plastic drums are required for delineation of a shoulder closure.
7. If a daytime shoulder closure must be maintained into the nighttime hours, replace the 28" or 36" standard traffic cones or 42" oversized traffic cones with portable plastic drums.
8. Reflectorize all portable plastic drums and 42" oversized traffic cones with Type III flexible microprismatic retroreflective sheeting.
9. On primary and secondary roadways, install shoulder closures as follows:

CASE I: Install advance warning signs and traffic control devices to provide a 250 foot taper in advance of the closed shoulder area and to delineate the closed shoulder area when a work zone occupies the shoulder area within 15 feet but not closer than 1 foot from the near edge of the adjacent travel lane. On high speed high volume multilane primary and secondary routes, a truck mounted attenuator supplemented with a truck mounted advance warning arrow panel is required; the truck mounted attenuator is optional on all other primary and secondary routes. The truck mounted advance warning arrow panel shall operate in a flashing arrow mode when pedestrian workers are present within 15 feet of the near edge of the adjacent travel lane; when pedestrian workers are not present operate the advance warning arrow panel in the "Four Corner" caution mode.
10. When a truck mounted attenuator is used, maintain the truck mounted attenuator approximately 100 feet in advance of the work activities. Maintain a minimum distance of 1 foot or greater between the truck mounted attenuator and the near edge of the adjacent travel lane.
11. Conduct the work in such a manner to avoid encroaching within 1 foot of the near edge of the adjacent travel lane. If the work activities cannot be performed under this traffic control setup without encroaching within 1 foot of the near edge of the adjacent travel lane, close the adjacent travel lane to traffic.
12. If work is being conducted at two different locations at the same time, separate the two locations by no less than 1 mile from the end of the first shoulder closure to the beginning of the taper of the second shoulder closure.
13. This traffic control setup for a right shoulder closure applies to closures of the left shoulder areas of secondary and primary routes.

DRAWING 515-02 LEFT SHOULDER CLOSURE (CASE I / CASE I) MULTILANE PRIMARY & SECONDARY ROUTES

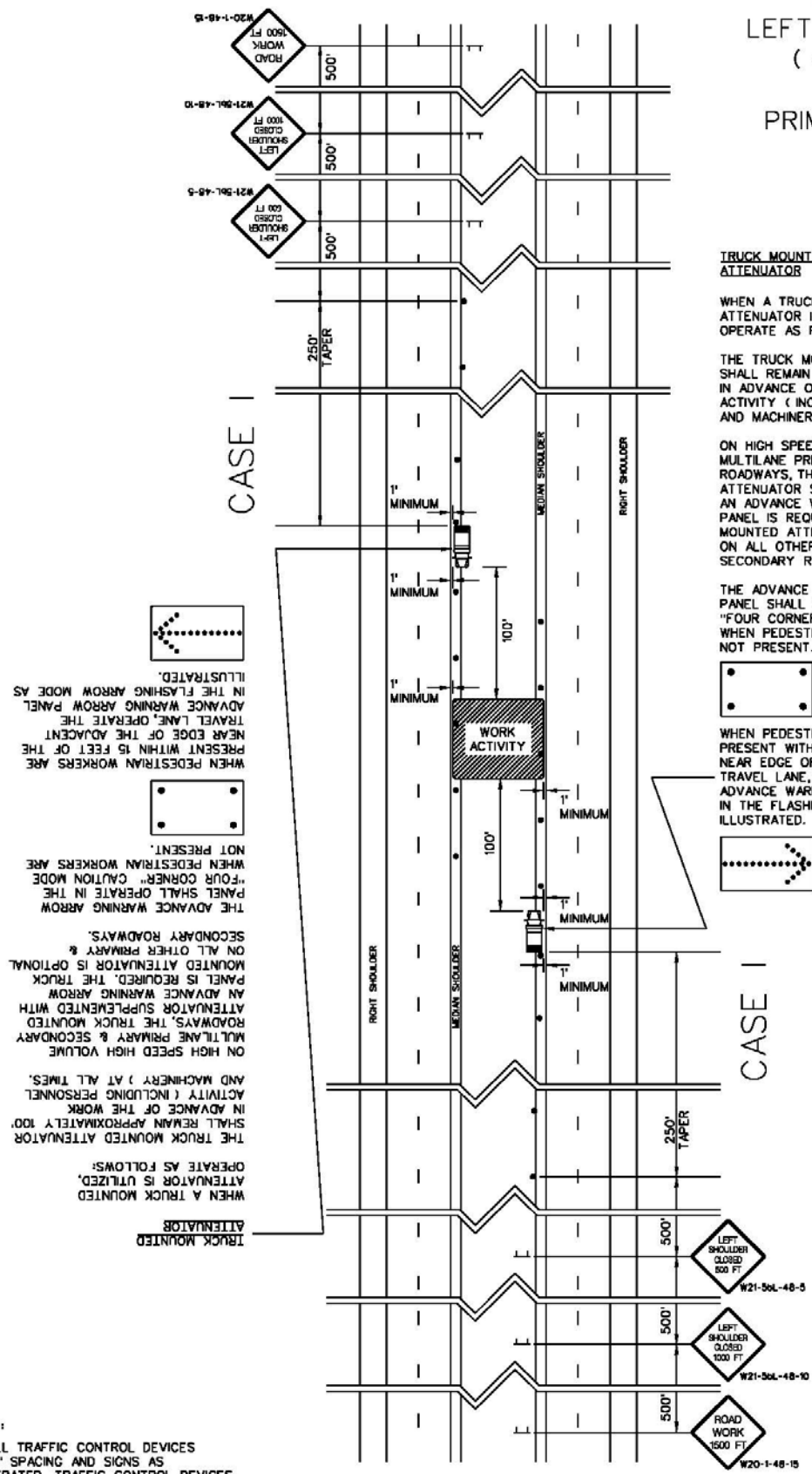

TRUCK MOUNTED ATTENUATOR

WHEN A TRUCK MOUNTED ATTENUATOR IS UTILIZED, OPERATE AS FOLLOWS:

THE TRUCK MOUNTED ATTENUATOR SHALL REMAIN APPROXIMATELY 100' IN ADVANCE OF THE WORK ACTIVITY (INCLUDING PERSONNEL AND MACHINERY) AT ALL TIMES.

ON HIGH SPEED HIGH VOLUME MULTILANE PRIMARY & SECONDARY ROADWAYS, THE TRUCK MOUNTED ATTENUATOR SUPPLEMENTED WITH AN ADVANCE WARNING ARROW PANEL IS REQUIRED. THE TRUCK MOUNTED ATTENUATOR IS OPTIONAL ON ALL OTHER PRIMARY & SECONDARY ROADWAYS.

THE ADVANCE WARNING ARROW PANEL SHALL OPERATE IN THE "FOUR CORNER" CAUTION MODE WHEN PEDESTRIAN WORKERS ARE NOT PRESENT.

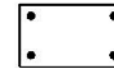

WHEN PEDESTRIAN WORKERS ARE PRESENT WITHIN 15 FEET OF THE NEAR EDGE OF THE ADJACENT TRAVEL LANE, OPERATE THE ADVANCE WARNING ARROW PANEL IN THE FLASHING ARROW MODE AS ILLUSTRATED.

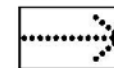

TRUCK MOUNTED ATTENUATOR
OPERATE AS FOLLOWS:
WHEN A TRUCK MOUNTED ATTENUATOR IS UTILIZED, OPERATE AS FOLLOWS:
THE TRUCK MOUNTED ATTENUATOR SHALL REMAIN APPROXIMATELY 100' IN ADVANCE OF THE WORK ACTIVITY (INCLUDING PERSONNEL AND MACHINERY) AT ALL TIMES.
ON HIGH SPEED HIGH VOLUME MULTILANE PRIMARY & SECONDARY ROADWAYS, THE TRUCK MOUNTED ATTENUATOR SUPPLEMENTED WITH AN ADVANCE WARNING ARROW PANEL IS REQUIRED. THE TRUCK MOUNTED ATTENUATOR IS OPTIONAL ON ALL OTHER PRIMARY & SECONDARY ROADWAYS.
THE ADVANCE WARNING ARROW PANEL SHALL OPERATE IN THE "FOUR CORNER" CAUTION MODE WHEN PEDESTRIAN WORKERS ARE NOT PRESENT.
WHEN PEDESTRIAN WORKERS ARE PRESENT WITHIN 15 FEET OF THE NEAR EDGE OF THE ADJACENT TRAVEL LANE, OPERATE THE ADVANCE WARNING ARROW PANEL IN THE FLASHING ARROW MODE AS ILLUSTRATED.

NOTE :
INSTALL TRAFFIC CONTROL DEVICES AT 50' SPACING AND SIGNS AS ILLUSTRATED. TRAFFIC CONTROL DEVICES SHOULD EXTEND NO LESS THAN 50' BEYOND THE WORK AREA.

**LEFT SHOULDER CLOSURE
(CASE I / CASE II)
MULTILANE
PRIMARY & SECONDARY ROUTES**

1. Install all advance warning signs as illustrated.
2. Install advance warning signs mounted on portable sign supports no less than 4 feet from the near edge of the sign to the near edge of an adjacent travel lane on roadways with grass shoulders and no less than 6 feet from the near edge of the sign to the near edge of an adjacent travel lane on roadways with paved shoulders. When a curb & gutter is present, install the sign no less than 2 feet from the near edge of the sign to the face of the curb.
3. On primary and secondary routes, the minimum mounting height of signs mounted on portable sign supports is 1 foot from the ground to the bottom edge of the sign during this traffic control setup.
4. The advance warning sign placement intervals illustrated are for normal conditions. Adjustments to the distance intervals between the signs may be necessary due to sight distance restrictions such as curves and hills.
5. During daytime hours, 28" or 36" standard traffic cones or 42" oversized traffic cones may be utilized for delineation of the shoulder closure. Standard traffic cones, 28" or 36" traffic cones, used during daytime hours are not required to be reflectorized. Delineation of a shoulder closure during nighttime hours with 28" or 36" standard traffic cones or 42" oversized traffic cones is PROHIBITED.
6. During nighttime hours, portable plastic drums are required for delineation of a shoulder closure.
7. If a daytime shoulder closure must be maintained into the nighttime hours, replace the 28" or 36" standard traffic cones or 42" oversized traffic cones with portable plastic drums.
8. Reflectorize all portable plastic drums and 42" oversized traffic cones with Type III flexible microprismatic retroreflective sheeting.
9. On primary and secondary roadways, install shoulder closures as follows:
 - CASE I: Install advance warning signs and traffic control devices to provide a 250 foot taper in advance of the closed shoulder area and to delineate the closed shoulder area when a work zone occupies the shoulder area within 15 feet but not closer than 1 foot from the near edge of the adjacent travel lane. On high speed high volume multilane primary and secondary routes, a truck mounted attenuator supplemented with a truck mounted advance warning arrow panel is required; the truck mounted attenuator is optional on all other primary and secondary routes. The truck mounted advance warning arrow panel shall operate in a flashing arrow mode when pedestrian workers are present within 15 feet of the near edge of the adjacent travel lane; when pedestrian workers are not present operate the advance warning arrow panel in the "Four Corner" caution mode.
 - CASE II: Only advance warning signs are required to be installed whenever a short term stationary or longer term work zone occupies any portion of the shoulder area beyond 15 feet but within 30 feet of the near edge of the adjacent travel lane.
10. When a truck mounted attenuator is used, maintain the truck mounted attenuator approximately 100 feet in advance of the work activities. Maintain a minimum distance of 1 foot or greater between the truck mounted attenuator and the near edge of the adjacent travel lane.
11. Conduct the work in such a manner to avoid encroaching within 1 foot of the near edge of the adjacent travel lane. If the work activities cannot be performed under this traffic control setup without encroaching within 1 foot of the near edge of the adjacent travel lane, close the adjacent travel lane to traffic.
12. If work is being conducted at two different locations at the same time, separate the two locations by no less than 1 mile from the end of the first shoulder closure to the beginning of the taper of the second shoulder closure.
13. This traffic control setup for a right shoulder closure applies to closures of the left shoulder areas of secondary and primary routes.

DRAWING 515-03
LEFT SHOULDER CLOSURE
(CASE I / CASE II)
MULTILANE
PRIMARY & SECONDARY
ROUTES

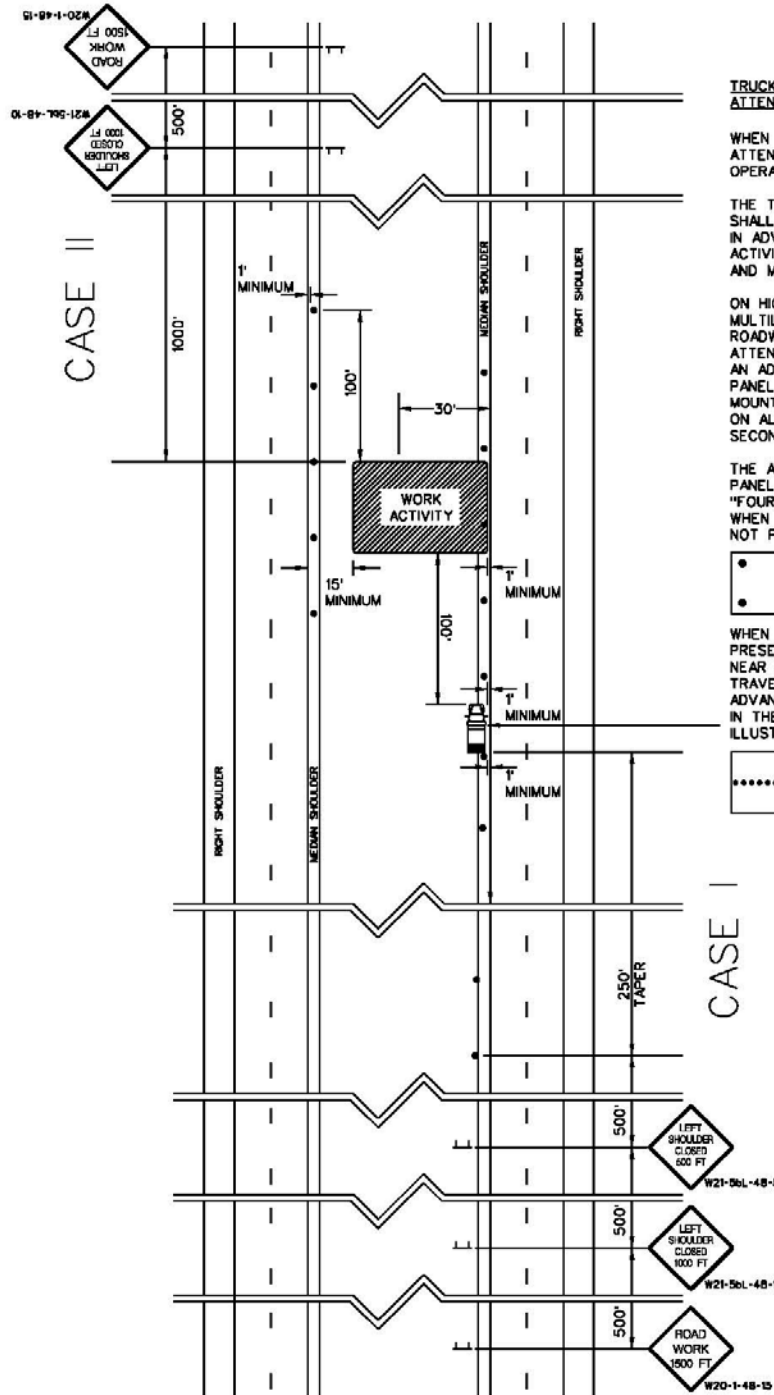

**TRUCK MOUNTED
ATTENUATOR**

WHEN A TRUCK MOUNTED
ATTENUATOR IS UTILIZED,
OPERATE AS FOLLOWS:

THE TRUCK MOUNTED ATTENUATOR
SHALL REMAIN APPROXIMATELY 100'
IN ADVANCE OF THE WORK
ACTIVITY (INCLUDING PERSONNEL
AND MACHINERY) AT ALL TIMES.

ON HIGH SPEED HIGH VOLUME
MULTILANE PRIMARY & SECONDARY
ROADWAYS, THE TRUCK MOUNTED
ATTENUATOR SUPPLEMENTED WITH
AN ADVANCE WARNING ARROW
PANEL IS REQUIRED. THE TRUCK
MOUNTED ATTENUATOR IS OPTIONAL
ON ALL OTHER PRIMARY &
SECONDARY ROADWAYS.

THE ADVANCE WARNING ARROW
PANEL SHALL OPERATE IN THE
"FOUR CORNER" CAUTION MODE
WHEN PEDESTRIAN WORKERS ARE
NOT PRESENT.

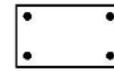

WHEN PEDESTRIAN WORKERS ARE
PRESENT WITHIN 15 FEET OF THE
NEAR EDGE OF THE ADJACENT
TRAVEL LANE, OPERATE THE
ADVANCE WARNING ARROW PANEL
IN THE FLASHING ARROW MODE AS
ILLUSTRATED.

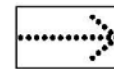

NOTE :
INSTALL TRAFFIC CONTROL DEVICES
AT 50' SPACING AND SIGNS AS
ILLUSTRATED. TRAFFIC CONTROL DEVICES
SHOULD EXTEND NO LESS THAN 50'
BEYOND THE WORK AREA.

SHOULDER CLOSURES

***INTERSTATE
ROUTES***

STANDARD DRAWING NO. 520-01

Through

STANDARD DRAWING NO. 520-06

**RIGHT SHOULDER CLOSURE
(CASE I / CASE II)
INTERSTATE ROUTES**

1. Install all advance warning signs as illustrated.
2. Install advance warning signs mounted on portable sign supports no less than 4 feet from the near edge of the sign to the near edge of an adjacent travel lane on roadways with grass shoulders and no less than 6 feet from the near edge of the sign to the near edge of an adjacent travel lane on roadways with paved shoulders. When a curb & gutter is present, install the sign no less than 2 feet from the near edge of the sign to the face of the curb.
3. **On interstate routes, the minimum mounting height of the advance warning signs mounted on portable sign supports is 5 feet from the ground to the bottom edge of the sign.**
4. The advance warning sign placement intervals illustrated are for normal conditions. Adjustments to the distance intervals between the signs may be necessary due to sight distance restrictions such as curves and hills.
5. During daytime hours, 36" standard traffic cones or 42" oversized traffic cones may be utilized for delineation of the shoulder closure. The 36" standard traffic cones used during daytime hours are not required to be reflectorized. Delineation of a shoulder closure during nighttime hours with 36" standard traffic cones or 42" oversized traffic cones is PROHIBITED.
6. During nighttime hours, portable plastic drums are required for delineation of a shoulder closure.
7. If a daytime work operation extends into the nighttime hours, replace the 36" standard traffic cones or 42" oversized traffic cones with portable plastic drums.
8. Reflectorize all portable plastic drums and 42" oversized traffic cones with Type III flexible microprismatic retroreflective sheeting.
9. On interstate roadways, install shoulder closures as follows:
 - CASE I: Install advance warning signs and traffic control devices to provide a 300 foot taper in advance of the closed shoulder area and to delineate the closed shoulder area whenever a short term stationary or longer term work zone occupies any portion of the shoulder area within 15 feet but not closer than 10 feet from the near edge of the adjacent travel lane. A truck mounted attenuator supplemented with a truck mounted advance warning arrow panel is required. The truck mounted advance warning arrow panel shall operate in a flashing arrow mode when pedestrian workers are present within 15 feet of the near edge of the adjacent travel lane; when pedestrian workers are not present operate the advance warning arrow panel in the "Four Corner" caution mode.
 - CASE II: Only advance warning signs are required to be installed whenever a short term stationary or longer term work zone occupies any portion of the shoulder area beyond 15 feet but within 30 feet of the near edge of the adjacent travel lane.
10. When a truck mounted attenuator is used, maintain the truck mounted attenuator approximately 100 feet in advance of the work activities. Maintain a minimum distance of 6 feet or greater between the truck mounted attenuator and the near edge of the adjacent travel lane.
11. Conduct the work in such a manner to avoid encroaching within 10 feet of the near edge of the adjacent travel lane. If the work activities cannot be performed under this traffic control setup without encroaching within 10 feet of the near edge of the adjacent travel lane, close the adjacent travel lane to traffic.
12. If work is being conducted at two different locations at the same time, separate the two locations by no less than 1 mile from the end of the first shoulder closure to the beginning of the taper of the second shoulder closure.
13. This traffic control setup for a right shoulder closure applies to closures of the right shoulder areas of interstate routes.

DRAWING 520-01
 RIGHT SHOULDER CLOSURE
 (CASE I / CASE II)
 INTERSTATE ROUTES

NOTE :
 INSTALL TRAFFIC CONTROL DEVICES
 AT 50' SPACING AND SIGNS AS
 ILLUSTRATED. TRAFFIC CONTROL DEVICES
 SHOULD EXTEND NO LESS THAN 50'
 BEYOND THE WORK AREA.

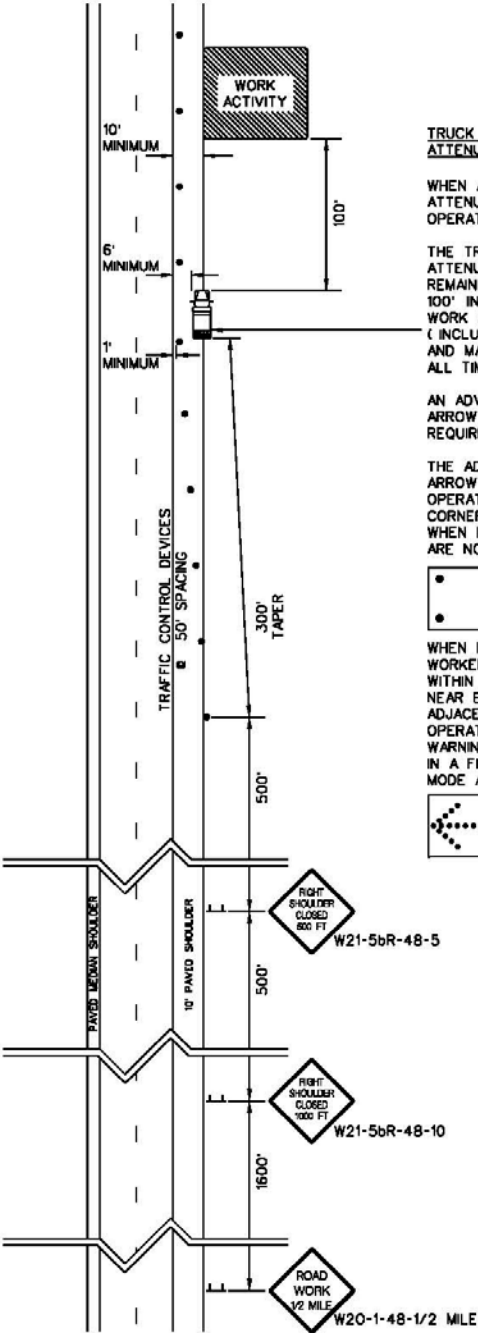

CASE I

TRUCK MOUNTED
 ATTENUATOR

WHEN A TRUCK MOUNTED
 ATTENUATOR IS UTILIZED,
 OPERATE AS FOLLOWS:

THE TRUCK MOUNTED
 ATTENUATOR SHALL
 REMAIN APPROXIMATELY
 100' IN ADVANCE OF THE
 WORK ACTIVITY
 (INCLUDING PERSONNEL
 AND MACHINERY) AT
 ALL TIMES.

AN ADVANCE WARNING
 ARROW PANEL IS
 REQUIRED ON THIS VEHICLE.

THE ADVANCE WARNING
 ARROW PANEL SHALL
 OPERATE IN THE "FOUR
 CORNER" CAUTION MODE
 WHEN PEDESTRIAN WORKERS
 ARE NOT PRESENT.



WHEN PEDESTRIAN
 WORKERS ARE PRESENT
 WITHIN 15 FEET OF THE
 NEAR EDGE OF THE
 ADJACENT TRAVEL LANE,
 OPERATE THE ADVANCE
 WARNING ARROW PANEL
 IN A FLASHING ARROW
 MODE AS ILLUSTRATED.

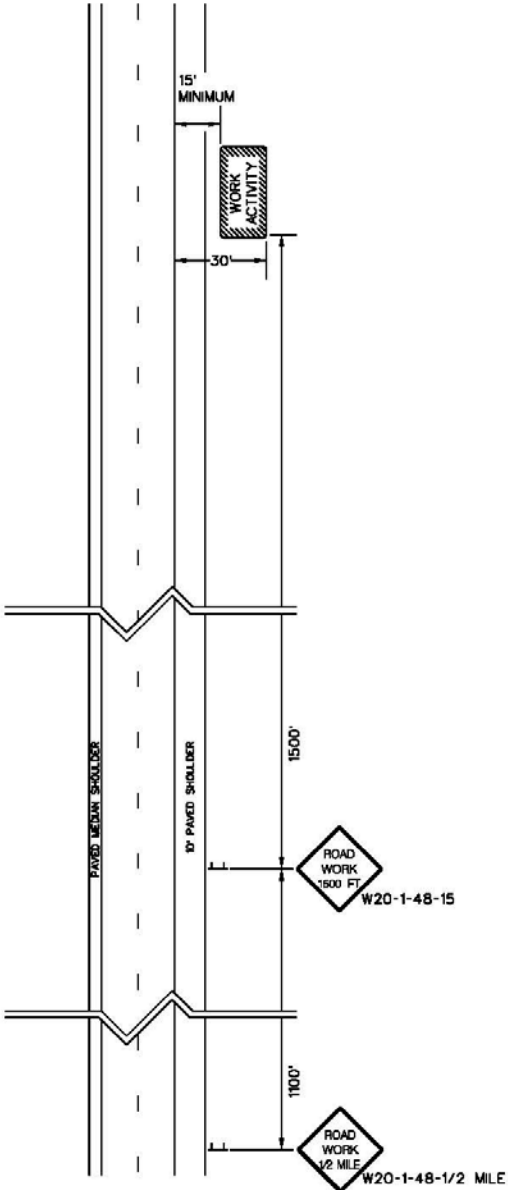
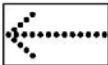

CASE II

**LEFT SHOULDER CLOSURE
(CASE I / CASE I)
NARROW MEDIAN
INTERSTATE ROUTES**

1. Install all advance warning signs as illustrated.
2. Install advance warning signs mounted on portable sign supports no less than 4 feet from the near edge of the sign to the near edge of an adjacent travel lane on roadways with grass shoulders and no less than 6 feet from the near edge of the sign to the near edge of an adjacent travel lane on roadways with paved shoulders. When a curb & gutter is present, install the sign no less than 2 feet from the near edge of the sign to the face of the curb.
3. **On interstate routes, the minimum mounting height of the advance warning signs mounted on portable sign supports is 5 feet from the ground to the bottom edge of the sign.**
4. The advance warning sign placement intervals illustrated are for normal conditions. Adjustments to the distance intervals between the signs may be necessary due to sight distance restrictions such as curves and hills.
5. During daytime hours, 36" standard traffic cones or 42" oversized traffic cones may be utilized for delineation of the shoulder closure. The 36" standard traffic cones used during daytime hours are not required to be reflectorized. Delineation of a shoulder closure during nighttime hours with 36" standard traffic cones or 42" oversized traffic cones is PROHIBITED.
6. During nighttime hours, portable plastic drums are required for delineation of a shoulder closure.
7. If a daytime work operation extends into the nighttime hours, replace the 36" standard traffic cones or 42" oversized traffic cones with portable plastic drums.
8. Reflectorize all portable plastic drums and 42" oversized traffic cones with Type III flexible microprismatic retroreflective sheeting.
9. On interstate roadways, install shoulder closures as follows:

CASE I: Install advance warning signs and traffic control devices to provide a 300 foot taper in advance of the closed shoulder area and to delineate the closed shoulder area whenever a short term stationary or longer term work zone occupies any portion of the shoulder area within 15 feet but not closer than 10 feet from the near edge of the adjacent travel lane. A truck mounted attenuator supplemented with a truck mounted advance warning arrow panel is required. The truck mounted advance warning arrow panel shall operate in a flashing arrow mode when pedestrian workers are present within 15 feet of the near edge of the adjacent travel lane; when pedestrian workers are not present operate the advance warning arrow panel in the "Four Corner" caution mode.
10. When a truck mounted attenuator is used, maintain the truck mounted attenuator approximately 100 feet in advance of the work activities. Maintain a minimum distance of 6 feet or greater between the truck mounted attenuator and the near edge of the adjacent travel lane.
11. Conduct the work in such a manner to avoid encroaching within 10 feet of the near edge of the adjacent travel lane. If the work activities cannot be performed under this traffic control setup without encroaching within 10 feet of the near edge of the adjacent travel lane, close the adjacent travel lane to traffic.
12. If work is being conducted at two different locations at the same time, separate the two locations by no less than 1 mile from the end of the first shoulder closure to the beginning of the taper of the second shoulder closure.
13. This traffic control setup for a left shoulder closure applies to closures of the left shoulder areas of interstate routes.

DRAWING 520-02 LEFT SHOULDER CLOSURE (CASE I / CASE I) NARROW MEDIAN INTERSTATE ROUTES

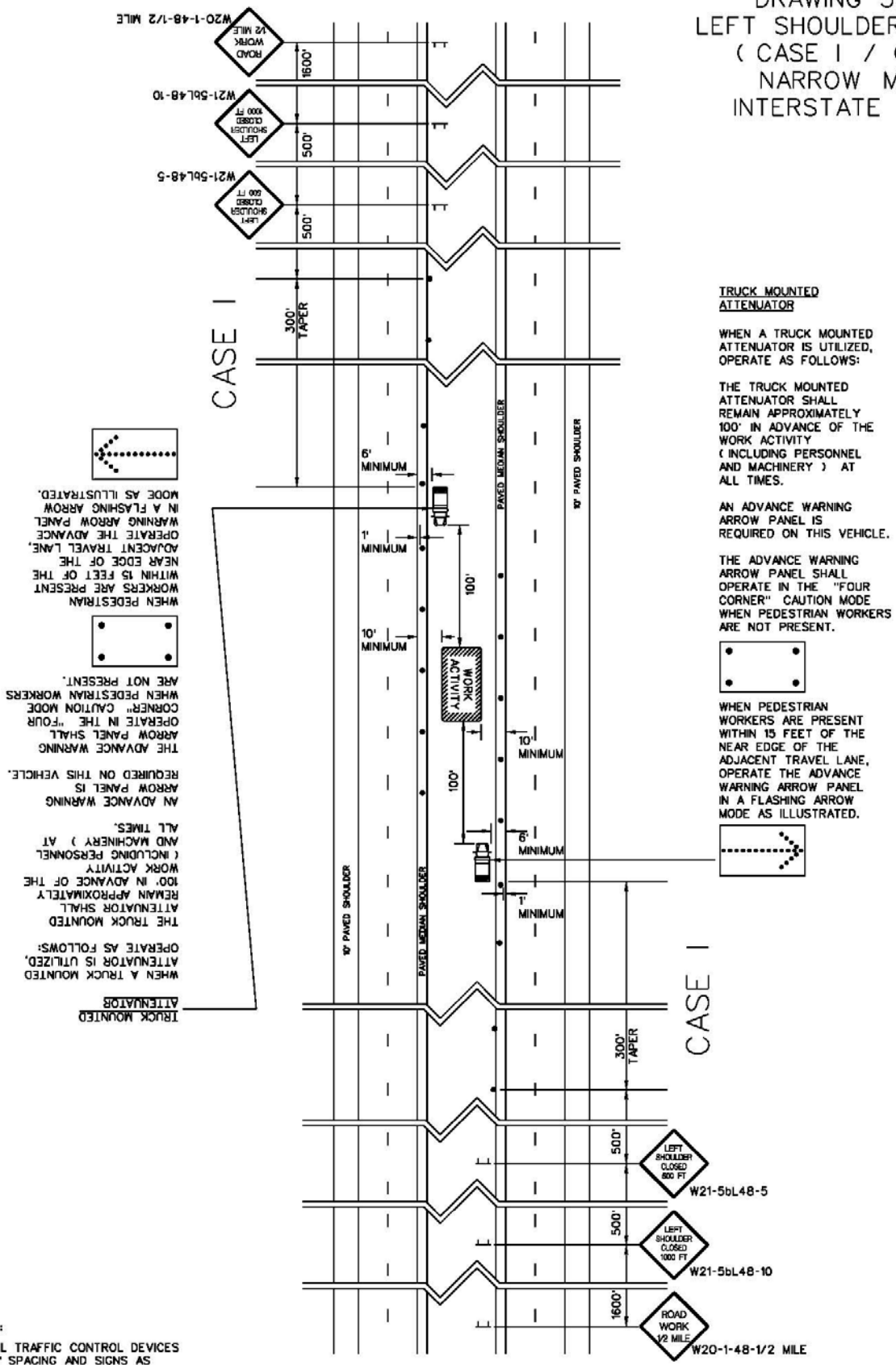

TRUCK MOUNTED ATTENUATOR

WHEN A TRUCK MOUNTED ATTENUATOR IS UTILIZED, OPERATE AS FOLLOWS:

THE TRUCK MOUNTED ATTENUATOR SHALL REMAIN APPROXIMATELY 100' IN ADVANCE OF THE WORK ACTIVITY (INCLUDING PERSONNEL AND MACHINERY) AT ALL TIMES.

AN ADVANCE WARNING ARROW PANEL IS REQUIRED ON THIS VEHICLE.

THE ADVANCE WARNING ARROW PANEL SHALL OPERATE IN THE "FOUR CORNER" CAUTION MODE WHEN PEDESTRIAN WORKERS ARE NOT PRESENT.

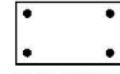

WHEN PEDESTRIAN WORKERS ARE PRESENT WITHIN 15 FEET OF THE NEAR EDGE OF THE ADJACENT TRAVEL LANE, OPERATE THE ADVANCE WARNING ARROW PANEL IN A FLASHING ARROW MODE AS ILLUSTRATED.

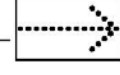

TRUCK MOUNTED ATTENUATOR

WHEN A TRUCK MOUNTED ATTENUATOR IS UTILIZED, OPERATE AS FOLLOWS:

THE TRUCK MOUNTED ATTENUATOR SHALL REMAIN APPROXIMATELY 100' IN ADVANCE OF THE WORK ACTIVITY (INCLUDING PERSONNEL AND MACHINERY) AT ALL TIMES.

AN ADVANCE WARNING ARROW PANEL IS REQUIRED ON THIS VEHICLE.

THE ADVANCE WARNING ARROW PANEL SHALL OPERATE IN THE "FOUR CORNER" CAUTION MODE WHEN PEDESTRIAN WORKERS ARE NOT PRESENT.

WHEN PEDESTRIAN WORKERS ARE PRESENT WITHIN 15 FEET OF THE NEAR EDGE OF THE ADJACENT TRAVEL LANE, OPERATE THE ADVANCE WARNING ARROW PANEL IN A FLASHING ARROW MODE AS ILLUSTRATED.

NOTE :

INSTALL TRAFFIC CONTROL DEVICES AT 50' SPACING AND SIGNS AS ILLUSTRATED. TRAFFIC CONTROL DEVICES SHOULD EXTEND NO LESS THAN 50' BEYOND THE WORK AREA.

**LEFT SHOULDER CLOSURE
(CASE I / CASE I)
WIDE MEDIAN
INTERSTATE ROUTES**

1. Install all advance warning signs as illustrated.
2. Install advance warning signs mounted on portable sign supports no less than 4 feet from the near edge of the sign to the near edge of an adjacent travel lane on roadways with grass shoulders and no less than 6 feet from the near edge of the sign to the near edge of an adjacent travel lane on roadways with paved shoulders. When a curb & gutter is present, install the sign no less than 2 feet from the near edge of the sign to the face of the curb.
3. **On interstate routes, the minimum mounting height of the advance warning signs mounted on portable sign supports is 5 feet from the ground to the bottom edge of the sign.**
4. The advance warning sign placement intervals illustrated are for normal conditions. Adjustments to the distance intervals between the signs may be necessary due to sight distance restrictions such as curves and hills.
5. During daytime hours, 36" standard traffic cones or 42" oversized traffic cones may be utilized for delineation of the shoulder closure. The 36" standard traffic cones used during daytime hours are not required to be reflectorized. Delineation of a shoulder closure during nighttime hours with 36" standard traffic cones or 42" oversized traffic cones is PROHIBITED.
6. During nighttime hours, portable plastic drums are required for delineation of a shoulder closure.
7. If a daytime work operation extends into the nighttime hours, replace the 36" standard traffic cones or 42" oversized traffic cones with portable plastic drums.
8. Reflectorize all portable plastic drums and 42" oversized traffic cones with Type III flexible microprismatic retroreflective sheeting.
9. On interstate roadways, install shoulder closures as follows:

CASE I: Install advance warning signs and traffic control devices to provide a 300 foot taper in advance of the closed shoulder area and to delineate the closed shoulder area whenever a short term stationary or longer term work zone occupies any portion of the shoulder area within 15 feet but not closer than 10 feet from the near edge of the adjacent travel lane. A truck mounted attenuator supplemented with a truck mounted advance warning arrow panel is required. The truck mounted advance warning arrow panel shall operate in a flashing arrow mode when pedestrian workers are present within 15 feet of the near edge of the adjacent travel lane; when pedestrian workers are not present operate the advance warning arrow panel in the "Four Corner" caution mode.
10. When a truck mounted attenuator is used, maintain the truck mounted attenuator approximately 100 feet in advance of the work activities. Maintain a minimum distance of 6 feet or greater between the truck mounted attenuator and the near edge of the adjacent travel lane.
11. Conduct the work in such a manner to avoid encroaching within 10 feet of the near edge of the adjacent travel lane. If the work activities cannot be performed under this traffic control setup without encroaching within 10 feet of the near edge of the adjacent travel lane, close the adjacent travel lane to traffic.
12. If work is being conducted at two different locations at the same time, separate the two locations by no less than 1 mile from the end of the first shoulder closure to the beginning of the taper of the second shoulder closure.
13. This traffic control setup for a left shoulder closure applies to closures of the left shoulder areas of interstate routes.

DRAWING 520-03
 LEFT SHOULDER CLOSURE
 (CASE I / CASE I)
 WIDE MEDIAN
 INTERSTATE ROUTES

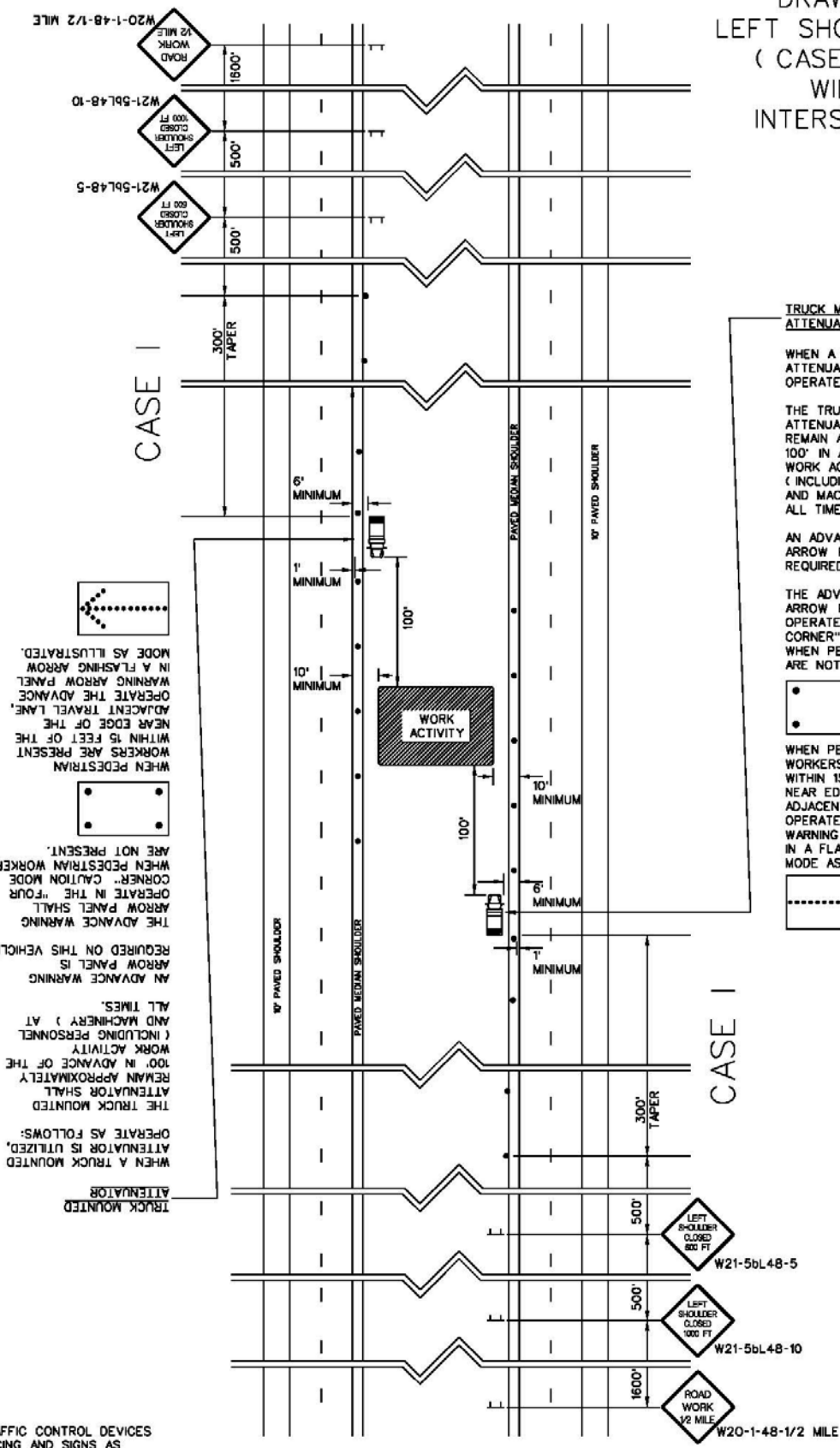

**TRUCK MOUNTED
 ATTENUATOR**

WHEN A TRUCK MOUNTED ATTENUATOR IS UTILIZED, OPERATE AS FOLLOWS:

THE TRUCK MOUNTED ATTENUATOR SHALL REMAIN APPROXIMATELY 100' IN ADVANCE OF THE WORK ACTIVITY (INCLUDING PERSONNEL AND MACHINERY) AT ALL TIMES.

AN ADVANCE WARNING ARROW PANEL IS REQUIRED ON THIS VEHICLE.

THE ADVANCE WARNING ARROW PANEL SHALL OPERATE IN THE "FOUR CORNER" CAUTION MODE WHEN PEDESTRIAN WORKERS ARE NOT PRESENT.



WHEN PEDESTRIAN WORKERS ARE PRESENT WITHIN 15 FEET OF THE NEAR EDGE OF THE ADJACENT TRAVEL LANE, OPERATE THE ADVANCE WARNING ARROW PANEL IN A FLASHING ARROW MODE AS ILLUSTRATED.

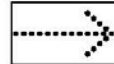

TRUCK MOUNTED ATTENUATOR
 WHEN A TRUCK MOUNTED ATTENUATOR IS UTILIZED, OPERATE AS FOLLOWS:
 THE TRUCK MOUNTED ATTENUATOR SHALL REMAIN APPROXIMATELY 100' IN ADVANCE OF THE WORK ACTIVITY (INCLUDING PERSONNEL AND MACHINERY) AT ALL TIMES.
 AN ADVANCE WARNING ARROW PANEL IS REQUIRED ON THIS VEHICLE.
 THE ADVANCE WARNING ARROW PANEL SHALL OPERATE IN THE "FOUR CORNER" CAUTION MODE WHEN PEDESTRIAN WORKERS ARE NOT PRESENT.
 WHEN PEDESTRIAN WORKERS ARE PRESENT WITHIN 15 FEET OF THE NEAR EDGE OF THE ADJACENT TRAVEL LANE, OPERATE THE ADVANCE WARNING ARROW PANEL IN A FLASHING ARROW MODE AS ILLUSTRATED.

NOTE :
 INSTALL TRAFFIC CONTROL DEVICES AT 50' SPACING AND SIGNS AS ILLUSTRATED. TRAFFIC CONTROL DEVICES SHOULD EXTEND NO LESS THAN 50' BEYOND THE WORK AREA.

**LEFT SHOULDER CLOSURE
(CASE I / CASE II)
WIDE MEDIAN
INTERSTATE ROUTES**

1. Install all advance warning signs as illustrated.
2. Install advance warning signs mounted on portable sign supports no less than 4 feet from the near edge of the sign to the near edge of an adjacent travel lane on roadways with grass shoulders and no less than 6 feet from the near edge of the sign to the near edge of an adjacent travel lane on roadways with paved shoulders. When a curb & gutter is present, install the sign no less than 2 feet from the near edge of the sign to the face of the curb.
3. **On interstate routes, the minimum mounting height of the advance warning signs mounted on portable sign supports is 5 feet from the ground to the bottom edge of the sign.**
4. The advance warning sign placement intervals illustrated are for normal conditions. Adjustments to the distance intervals between the signs may be necessary due to sight distance restrictions such as curves and hills.
5. During daytime hours, 36" standard traffic cones or 42" oversized traffic cones may be utilized for delineation of the shoulder closure. The 36" standard traffic cones used during daytime hours are not required to be reflectorized. Delineation of a shoulder closure during nighttime hours with 36" standard traffic cones or 42" oversized traffic cones is PROHIBITED.
6. During nighttime hours, portable plastic drums are required for delineation of a shoulder closure.
7. If a daytime work operation extends into the nighttime hours, replace the 36" standard traffic cones or 42" oversized traffic cones with portable plastic drums.
8. Reflectorize all portable plastic drums and 42" oversized traffic cones with Type III flexible microprismatic retroreflective sheeting.
9. On interstate roadways, install shoulder closures as follows:
 - CASE I: Install advance warning signs and traffic control devices to provide a 300 foot taper in advance of the closed shoulder area and to delineate the closed shoulder area whenever a short term stationary or longer term work zone occupies any portion of the shoulder area within 15 feet but not closer than 10 feet from the near edge of the adjacent travel lane. A truck mounted attenuator supplemented with a truck mounted advance warning arrow panel is required. The truck mounted advance warning arrow panel shall operate in a flashing arrow mode when pedestrian workers are present within 15 feet of the near edge of the adjacent travel lane; when pedestrian workers are not present operate the advance warning arrow panel in the "Four Corner" caution mode.
 - CASE II: Only advance warning signs are required to be installed whenever a short term stationary or longer term work zone occupies any portion of the shoulder area beyond 15 feet but within 30 feet of the near edge of the adjacent travel lane.
10. When a truck mounted attenuator is used, maintain the truck mounted attenuator approximately 100 feet in advance of the work activities. Maintain a minimum distance of 6 feet or greater between the truck mounted attenuator and the near edge of the adjacent travel lane.
11. Conduct the work in such a manner to avoid encroaching within 10 feet of the near edge of the adjacent travel lane. If the work activities cannot be performed under this traffic control setup without encroaching within 10 feet of the near edge of the adjacent travel lane, close the adjacent travel lane to traffic.
12. If work is being conducted at two different locations at the same time, separate the two locations by no less than 1 mile from the end of the first shoulder closure to the beginning of the taper of the second shoulder closure.
13. This traffic control setup for a left shoulder closure applies to closures of the left shoulder areas of interstate routes.

DRAWING 520-04
LEFT SHOULDER CLOSURE
(CASE I / CASE II)
WIDE MEDIAN
INTERSTATE ROUTES

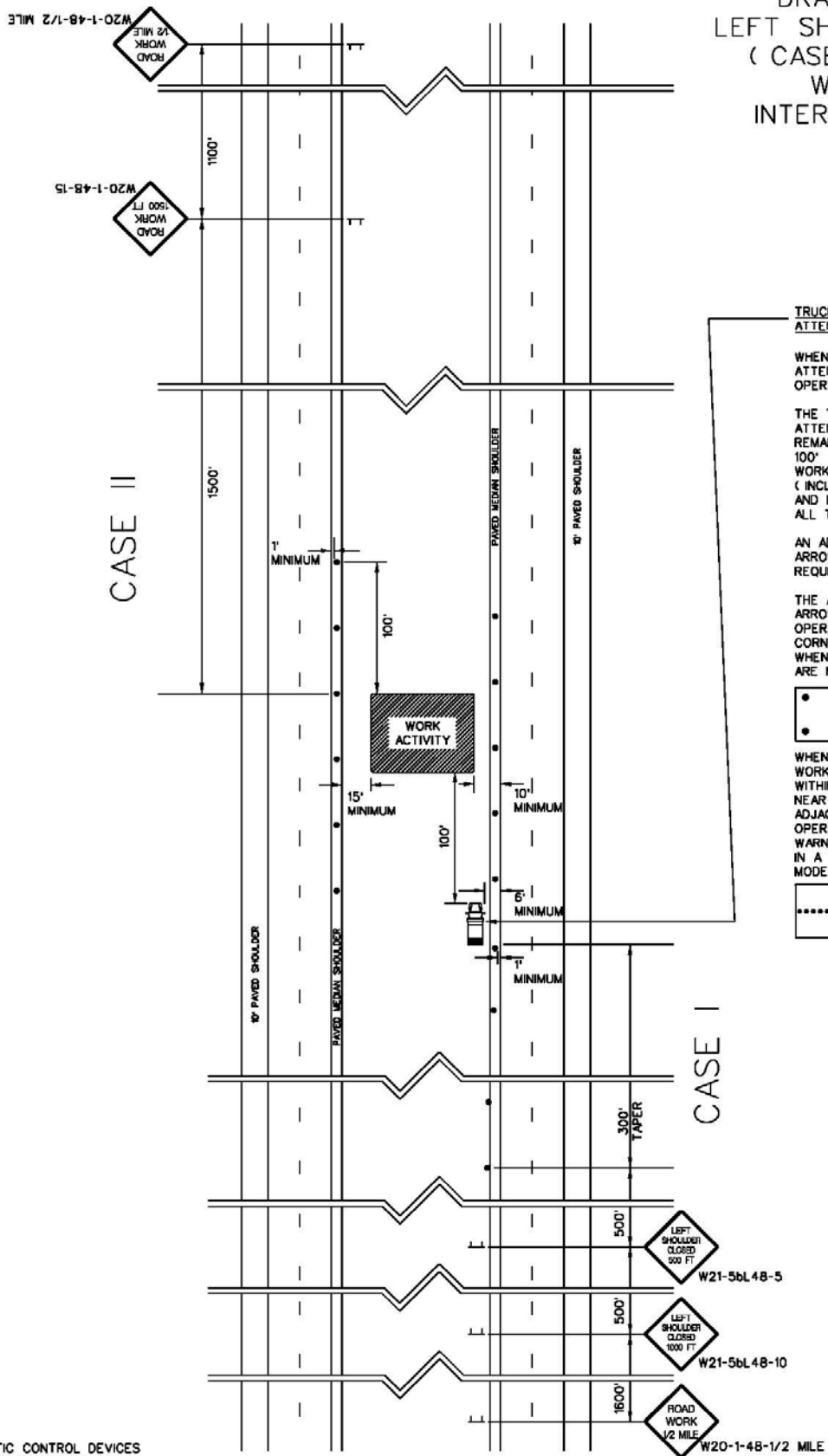

**TRUCK MOUNTED
ATTENUATOR**

WHEN A TRUCK MOUNTED
ATTENUATOR IS UTILIZED,
OPERATE AS FOLLOWS:

THE TRUCK MOUNTED
ATTENUATOR SHALL
REMAIN APPROXIMATELY
100' IN ADVANCE OF THE
WORK ACTIVITY
(INCLUDING PERSONNEL
AND MACHINERY) AT
ALL TIMES.

AN ADVANCE WARNING
ARROW PANEL IS
REQUIRED ON THIS VEHICLE.

THE ADVANCE WARNING
ARROW PANEL SHALL
OPERATE IN THE "FOUR
CORNER" CAUTION MODE
WHEN PEDESTRIAN WORKERS
ARE NOT PRESENT.

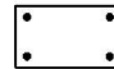

WHEN PEDESTRIAN
WORKERS ARE PRESENT
WITHIN 15 FEET OF THE
NEAR EDGE OF THE
ADJACENT TRAVEL LANE,
OPERATE THE ADVANCE
WARNING ARROW PANEL
IN A FLASHING ARROW
MODE AS ILLUSTRATED.

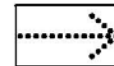

NOTE :
INSTALL TRAFFIC CONTROL DEVICES
AT 50' SPACING AND SIGNS AS
ILLUSTRATED. TRAFFIC CONTROL DEVICES
SHOULD EXTEND NO LESS THAN 50'
BEYOND THE WORK AREA.

**LEFT SHOULDER CLOSURE
(CASE II / CASE II)
WIDE MEDIAN
INTERSTATE ROUTES**

1. Install all advance warning signs as illustrated.
2. Install advance warning signs mounted on portable sign supports no less than 4 feet from the near edge of the sign to the near edge of an adjacent travel lane on roadways with grass shoulders and no less than 6 feet from the near edge of the sign to the near edge of an adjacent travel lane on roadways with paved shoulders. When a curb & gutter is present, install the sign no less than 2 feet from the near edge of the sign to the face of the curb.
3. **On interstate routes, the minimum mounting height of the advance warning signs mounted on portable sign supports is 5 feet from the ground to the bottom edge of the sign.**
4. The advance warning sign placement intervals illustrated are for normal conditions. Adjustments to the distance intervals between the signs may be necessary due to sight distance restrictions such as curves and hills.
5. During daytime hours, 36" standard traffic cones or 42" oversized traffic cones may be utilized for delineation of the shoulder closure. The 36" standard traffic cones used during daytime hours are not required to be reflectorized. Delineation of a shoulder closure during nighttime hours with 36" standard traffic cones or 42" oversized traffic cones is PROHIBITED.
6. During nighttime hours, portable plastic drums are required for delineation of a shoulder closure.
7. If a daytime work operation extends into the nighttime hours, replace the 36" standard traffic cones or 42" oversized traffic cones with portable plastic drums.
8. Reflectorize all portable plastic drums and 42" oversized traffic cones with Type III flexible microprismatic retroreflective sheeting.
9. On interstate roadways, install shoulder closures as follows:

CASE II: Only advance warning signs are required to be installed whenever a short term stationary or longer term work zone occupies any portion of the shoulder area beyond 15 feet but within 30 feet of the near edge of the adjacent travel lane.
10. If work is being conducted at two different locations at the same time, separate the two locations by no less than 1 mile from the end of the first shoulder closure to the beginning of the taper of the second shoulder closure.
11. This traffic control setup for a left shoulder closure applies to closures of the left shoulder areas of interstate routes.

DRAWING 520-05
 LEFT SHOULDER CLOSURE
 (CASE II / CASE II)
 WIDE MEDIAN
 INTERSTATE ROUTES

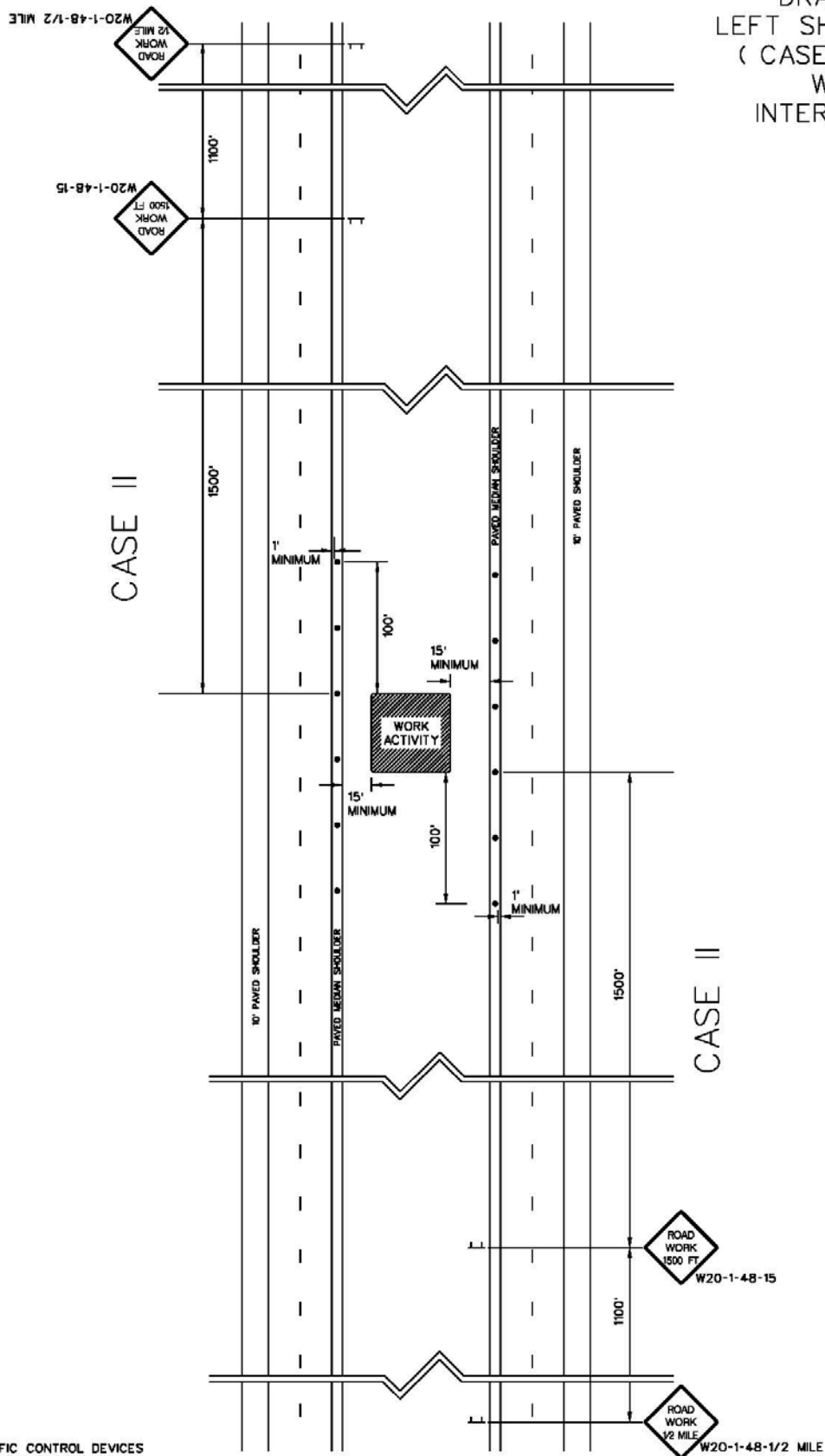

NOTE :
 INSTALL TRAFFIC CONTROL DEVICES
 AT 50' SPACING AND SIGNS AS
 ILLUSTRATED. TRAFFIC CONTROL DEVICES
 SHOULD EXTEND NO LESS THAN 50'
 BEYOND THE WORK AREA.

**SHOULDER CLOSURE
GORE AREA
INTERSTATE ROUTES**

1. Install all advance warning signs as illustrated.
2. Install advance warning signs mounted on portable sign supports no less than 4 feet from the near edge of the sign to the near edge of an adjacent travel lane on roadways with grass shoulders and no less than 6 feet from the near edge of the sign to the near edge of an adjacent travel lane on roadways with paved shoulders. When a curb & gutter is present, install the sign no less than 2 feet from the near edge of the sign to the face of the curb.
3. **On interstate routes, the minimum mounting height of the advance warning signs mounted on portable sign supports is 5 feet from the ground to the bottom edge of the sign.**
4. The advance warning sign placement intervals illustrated are for normal conditions. Adjustments to the distance intervals between the signs may be necessary due to sight distance restrictions such as curves and hills.
5. During daytime hours, 36" standard traffic cones or 42" oversized traffic cones may be utilized for delineation of the gore / shoulder area. The 36" standard traffic cones used during daytime hours are not required to be reflectorized. Delineation of a gore / shoulder area during nighttime hours with 36" standard traffic cones or 42" oversized traffic cones is PROHIBITED.
6. During nighttime hours, portable plastic drums are required for delineation of a gore / shoulder area.
7. If a daytime work operation extends into the nighttime hours, replace the 36" standard traffic cones or 42" oversized traffic cones with portable plastic drums.
8. Reflectorize all portable plastic drums and 42" oversized traffic cones with Type III flexible microprismatic retroreflective sheeting.
9. Due to the restrictive boundaries of the work site, the site conditions will determine the specific location of the truck mounted attenuator. When site conditions do not provide sufficient space for desired space intervals, maximize the space that is available. The desired space intervals are as follows:
 - A. Maintain the maximum distance interval available, up to but not more than 100 feet, between the front of the truck mounted attenuator and the work site. The boundaries of the work site will include all areas where personnel, equipment and materials are present.
 - B. Maintain the maximum lateral distance interval available, preferably no less than 6 feet, between the truck mounted attenuator and the near edge line of the adjacent travel lane.
 - C. Maintain the maximum lateral distance interval available, preferably no less than 6 feet, between the truck mounted attenuator and the near edge line of the adjacent ramp.
10. This traffic control setup for a gore area applies to closures of the gore and adjacent shoulder areas of interstate routes.

DRAWING 520-06
SHOULDER CLOSURE
GORE AREA
INTERSTATE ROUTES

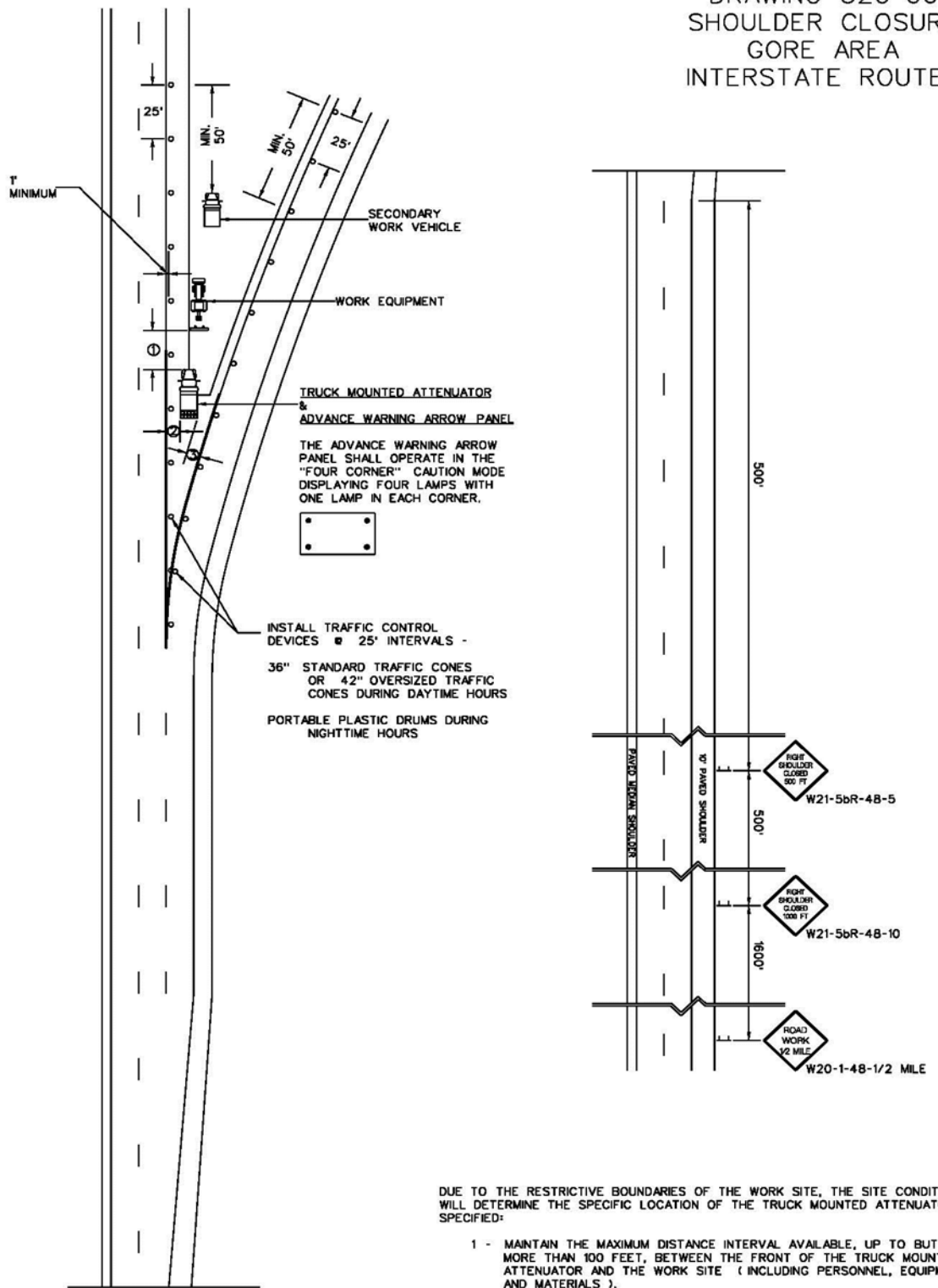

NOTE :

INSTALL TRAFFIC CONTROL DEVICES AT 25' SPACING AND SIGNS AS ILLUSTRATED. TRAFFIC CONTROL DEVICES SHOULD EXTEND NO LESS THAN 50' BEYOND THE WORK AREA OR LAST WORK VEHICLE AS ILLUSTRATED.

DUE TO THE RESTRICTIVE BOUNDARIES OF THE WORK SITE, THE SITE CONDITIONS WILL DETERMINE THE SPECIFIC LOCATION OF THE TRUCK MOUNTED ATTENUATOR AS SPECIFIED:

- 1 - MAINTAIN THE MAXIMUM DISTANCE INTERVAL AVAILABLE, UP TO BUT NOT MORE THAN 100 FEET, BETWEEN THE FRONT OF THE TRUCK MOUNTED ATTENUATOR AND THE WORK SITE (INCLUDING PERSONNEL, EQUIPMENT AND MATERIALS).
- 2 - MAINTAIN THE MAXIMUM LATERAL DISTANCE INTERVAL AVAILABLE, PREFERABLY NO LESS THAN 6 FEET, BETWEEN THE TRUCK MOUNTED ATTENUATOR AND THE NEAR EDGE LINE OF THE ADJACENT TRAVEL LANE.
- 3 - MAINTAIN THE MAXIMUM LATERAL DISTANCE INTERVAL AVAILABLE, PREFERABLY NO LESS THAN 6 FEET, BETWEEN THE TRUCK MOUNTED ATTENUATOR AND THE NEAR EDGE LINE OF THE ADJACENT RAMP.

MOBILIZED SHOULDER OPERATIONS

***PRIMARY
&
SECONDARY
ROUTES***

STANDARD DRAWING NO. 525-01

Through

STANDARD DRAWING NO. 525-04

**MOBILIZED SHOULDER OPERATIONS
ROAD MACHINERY - MINOR ENCROACHMENT
PRIMARY & SECONDARY ROUTES**

1. These mobilized shoulder operations are short duration work zones involving road machinery that slowly progress along the roadway while conducting work activities within the roadway shoulders. Equipment for these operations occupies the shoulder while conducting the work. The equipment may encroach upon the adjacent travel lane up to but not more than 2 feet where sufficient shoulder space is available. **Brief periodic encroachments upon the adjacent travel lane greater than 2 feet for the equipment to relocate or bypass structures such as guardrail locations or bridge structures are acceptable.**

2. Utilize advance warning signs relative to the type of work activity being conducted. The various types of advance warning sign assemblies that may be utilized shall include the "Mowing" sign (W21-9-48) supplemented with the supplemental sign "Next 3 Miles" (W7-3a-42) for grass mowing operations.

Due to the mobility of these operations and the minor encroachment onto the adjacent travel lane, minimum traffic control requirements specify the installation of advance warning sign assemblies for each approach that may be impacted by the work activities. On two-lane two-way roadways, install an advance warning sign assembly on each approach to the work area. On multilane roadways, install an advance warning sign assembly on the shoulder the work is being performed in. Relocate these advance warning sign assemblies as necessary as the work area is advanced along the roadway.

Additional traffic control devices relative to the site condition may be utilized, i.e. truck mounted changeable message signs.

3. This traffic control setup applies to a short duration work zone that involves road machinery which may encroach upon an adjacent travel lane up to 2 feet while slowly progressing along the roadway. The most common work activity performed under this traffic control setup is a grass mowing operation.

DRAWING 525-01
 MOBILIZED SHOULDER OPERATIONS
 ROAD MACHINERY - MINOR ENCROACHMENT
 PRIMARY & SECONDARY ROUTES

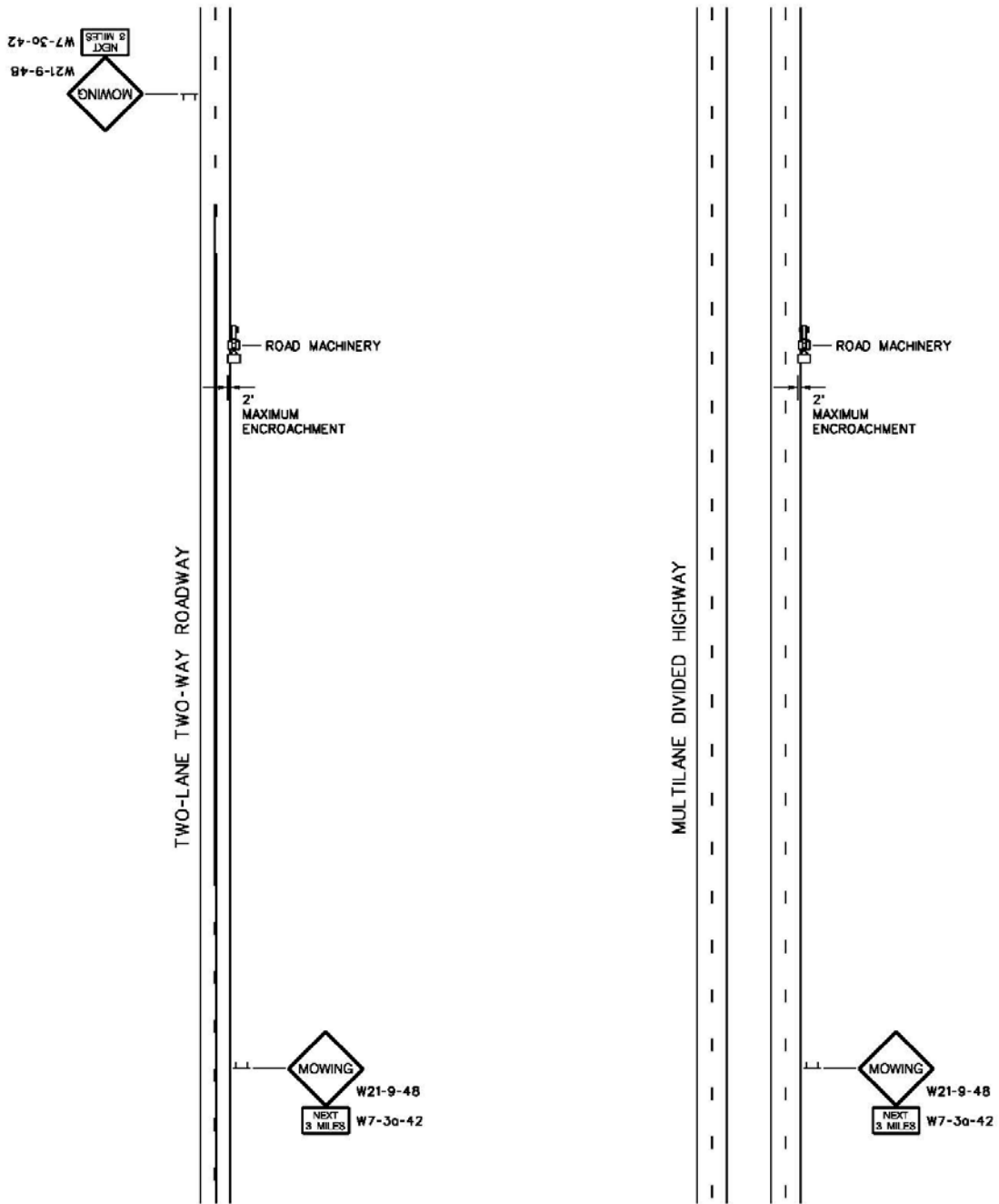

GENERAL NOTE

UTILIZE ADVANCE WARNING SIGNING RELATIVE TO THE TYPE OF WORK ACTIVITY BEING CONDUCTED. THE VARIOUS TYPES OF ADVANCE WARNING SIGN ASSEMBLIES THAT MAY BE UTILIZED SHALL INCLUDE THE "MOWING" SIGN (W21-9-48) SUPPLEMENTED WITH THE SUPPLEMENTAL SIGN "NEXT 3 MILES" (W7-3a-42) FOR GRASS MOWING OPERATIONS. THE SIGN ASSEMBLIES ILLUSTRATED ARE TYPICAL AND MAY BE SUBSTITUTED WITH SIGNS APPROPRIATE TO THE TYPE OF WORK ACTIVITY BEING PERFORMED UNDER THIS TRAFFIC CONTROL SETUP.

**MOBILIZED SHOULDER OPERATIONS
PEDESTRIAN WORKERS - NO ENCROACHMENT
ROAD MACHINERY - MINOR ENCROACHMENT
PRIMARY & SECONDARY ROUTES**

1. These mobilized shoulder operations are short duration work zones involving pedestrian workers that slowly progress along the roadway while conducting work activities within a limited area of a roadway shoulder. These mobilized shoulder operations include pedestrian workers and a work vehicle and may also include work equipment. The pedestrian workers may perform work activities up to but not closer than 1 foot from the adjacent travel lane. The work vehicle may encroach upon the adjacent travel lane up to but not more than 2 feet where sufficient shoulder space is available. **Brief periodic encroachments upon the adjacent travel lane greater than 2 feet for the work vehicle to relocate or bypass structures such as guardrail locations or bridge structures are acceptable.**

2. On two-lane two-way roadways, flagging operations are required for these work activities when pedestrian workers are required to perform work activities within 1 foot or less from the adjacent travel lane or encroach upon the adjacent travel lane.

3. On multilane roadways, lane closures are required for these work activities when pedestrian workers are required to perform work activities within 1 foot or less from the adjacent travel lane or encroach upon the adjacent travel lane.

4. A work vehicle shall accompany the pedestrian workers as illustrated at all times when pedestrian workers are within 15 feet or less of an adjacent travel lane. The work vehicle shall remain within 100 feet of the work location for the pedestrian workers at all times. **Supplement the work vehicle with amber colored auxiliary warning lights. The auxiliary warning lights shall be high intensity rotating, flashing, oscillating or strobe lights. Standard vehicle hazard warning lights are only permitted as a supplement to the auxiliary warning lights.**

5. Utilize advance warning signs relative to the type of work activity being conducted. The "Worker" sign (W21-1-48) is required when pedestrian workers are present. The "Worker" sign (W21-1-48) may be installed in addition to those signs relative to work activities that may not require pedestrian workers. For example, the "Worker" sign (W21-1-48) may be installed in addition to the "Mowing" sign (W21-9-48) when appropriate.

Due to the mobility of these operations, minimum traffic control requirements specify the installation of advance warning sign assemblies for each approach that may be impacted by the work activities. On two-lane two-way roadways, install an advance warning sign assembly on each approach to the work area. On multilane roadways, install an advance warning sign assembly on the shoulder the work is being performed in. Relocate these advance warning sign assemblies as necessary as the work area is advanced along the roadway.

Additional traffic control devices relative to the site condition may be utilized, i.e. truck mounted changeable message signs.

6. Whenever a shoulder closure is required, supplement the shoulder closure advance warning sign array with an advance warning sign assembly appropriate to the type of work activity being conducted. Install this supplemental advance warning sign in advance of the shoulder closure advance warning sign array at an interval spacing appropriate to the posted regulatory speed as prescribed by this manual.

7. This traffic control setup applies to short duration work zones within a defined area of the roadway shoulder that includes pedestrian workers and slowly progresses along the roadway. The most common work activity performed under this traffic control setup is a hand trimming operation performed during grass mowing operations.

DRAWING 525-02
 MOBILIZED SHOULDER OPERATIONS
 PEDESTRIAN WORKERS - NO ENCROACHMENT
 ROAD MACHINERY - MINOR ENCROACHMENT
 PRIMARY & SECONDARY ROUTES

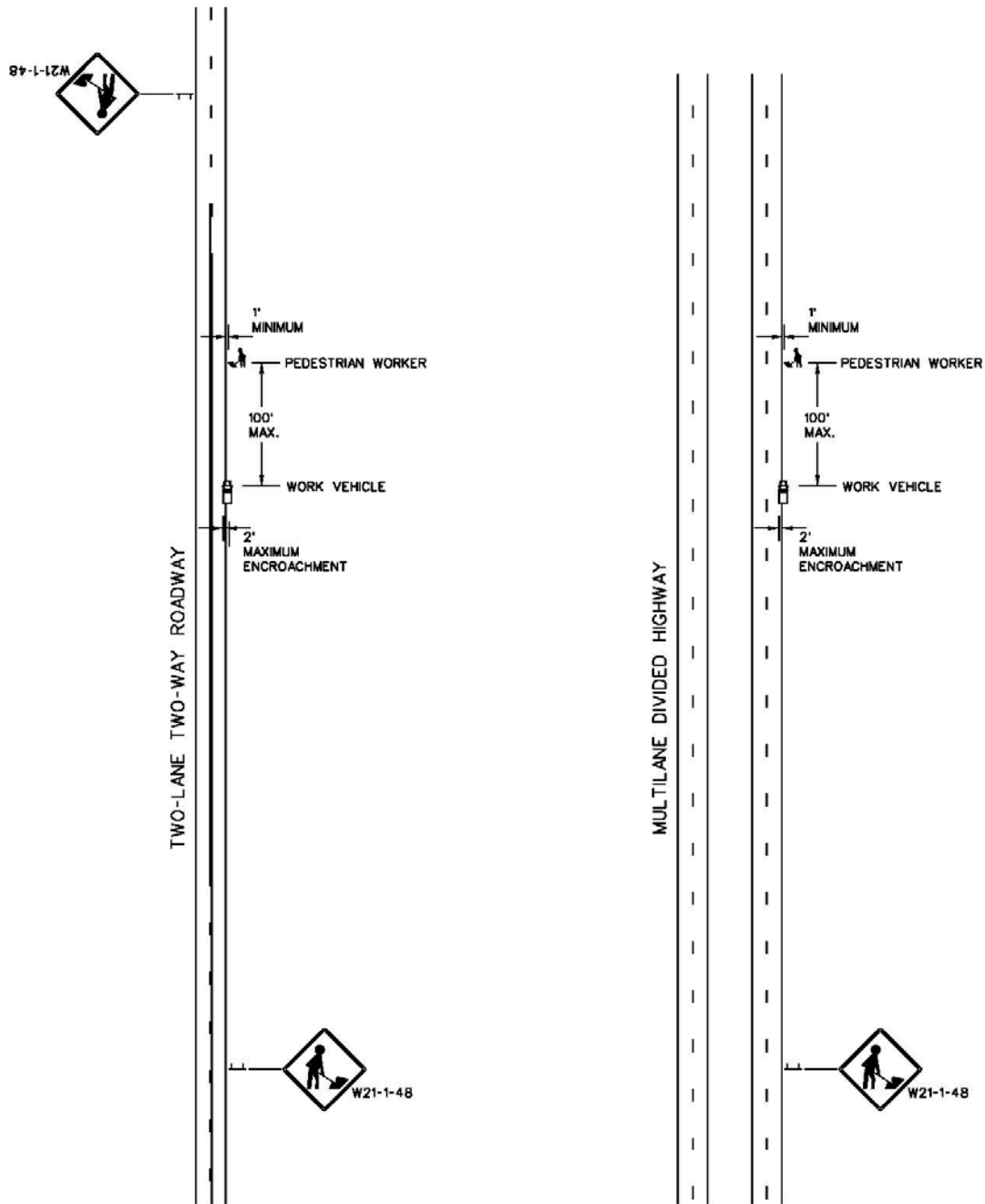

GENERAL NOTE

UTILIZE ADVANCE WARNING SIGNING RELATIVE TO THE TYPE OF WORK ACTIVITY BEING CONDUCTED. THE VARIOUS TYPES OF ADVANCE WARNING SIGN ASSEMBLIES THAT MAY BE UTILIZED SHALL INCLUDE THE "WORKER" SIGN (W21-1-48) WHEN PEDESTRIAN WORKERS ARE PRESENT. THE SIGN ASSEMBLIES ILLUSTRATED ARE TYPICAL AND MAY BE SUBSTITUTED WITH SIGNS APPROPRIATE TO THE TYPE OF WORK BEING PERFORMED UNDER THIS TRAFFIC CONTROL SETUP.

**MOBILIZED SHOULDER OPERATIONS
ROAD MACHINERY - MAJOR ENCROACHMENT
PRIMARY & SECONDARY ROUTES**

1. These mobilized shoulder operations are short duration shoulder area work zones with no more than one (1) single equipment unit that slowly progresses along the roadway while conducting work activities within the roadway shoulders. Equipment for these operations consists of one (1) single equipment unit that occupies the shoulder and will encroach into the adjacent travel lane while continuously moving. The equipment may encroach upon the adjacent travel lane beyond 2 feet and at times may occupy the entire travel lane adjacent to the shoulder in which the work is being conducted. The single equipment unit must be accompanied by a shadow vehicle when a sufficient stopping sight distance interval between the single equipment unit and an approaching motorist is unavailable based upon the posted regulatory speed limit of the roadway.
2. On two-lane two-way roadways, when more than one (1) single equipment unit, not including a shadow vehicle when one is necessary, is required to perform the work activities, flagging operations are required.
3. On multilane roadways, when more than one (1) single equipment unit, not including a shadow vehicle when one is necessary, is required to perform the work activities, lane closures are required.
4. Due to the mobility of these operations with the major encroachment onto the adjacent travel lane, traffic control requirements for these work activities will depend upon the roadway type.

Two-Lane Two-Way Roadways – Utilize the requirements for intermittent mobile operations. The Vehicle Train requirements will apply. Equip all vehicles, road machinery and equipment included in the Vehicle Train with AMBER or YELLOW colored high intensity rotating, flashing, oscillating or strobe auxiliary warning lights. On low volume roadways, a shadow vehicle is not required; the vehicle train may consist of only a work vehicle or a road machinery unit. On intermediate and high volume roadways, a vehicle train consisting of a work vehicle or a road machinery unit and a shadow vehicle is required in locations where a sufficient stopping sight distance interval between the work vehicle or a road machinery unit and an approaching motorist is unavailable based upon the posted regulatory speed limit of the specific location. When a shadow vehicle is required, the distance interval from the shadow vehicle to the work vehicle or the road machinery unit may vary from a minimum distance of 50 feet up to but not more than the stopping sight distance based upon the posted regulatory speed limit of the specific location.

Multilane Roadways – Utilize the requirements for intermittent mobile operations. The Vehicle Train requirements will apply. Equip all vehicles, road machinery and equipment included in the Vehicle Train with AMBER or YELLOW colored high intensity rotating, flashing, oscillating or strobe auxiliary warning lights. On intermediate and high volume roadways, a vehicle train consisting of a work vehicle or a road machinery unit and a shadow vehicle is required in locations where a sufficient stopping sight distance interval between the work vehicle or a road machinery unit and an approaching motorist is unavailable based upon the posted regulatory speed limit of the specific location. When a shadow vehicle is required, the distance interval from the shadow vehicle to the work vehicle or the road machinery unit may vary from a minimum distance of 50 feet up to but not more than the stopping sight distance based upon the posted regulatory speed limit of the specific location.

Additional traffic control devices relative to the site condition may be utilized, i.e. truck mounted changeable message signs.

5. **Supplement all vehicles within the Vehicle Train with amber colored auxiliary warning lights. The auxiliary warning lights shall be high intensity rotating, flashing, oscillating or strobe lights. Standard vehicle hazard warning lights are only permitted as a supplement to the auxiliary warning lights.**
6. This traffic control setup applies to a short duration work zone that involves road machinery which may encroach upon an adjacent travel lane beyond 2 feet and at times may occupy an entire travel lane while slowly progressing along the roadway. The most common work activity performed under this traffic control setup is a mowing operation with a boom attachment.

DRAWING 525-03
MOBILIZED SHOULDER OPERATIONS
ROAD MACHINERY - MAJOR ENCROACHMENT
PRIMARY & SECONDARY ROUTES

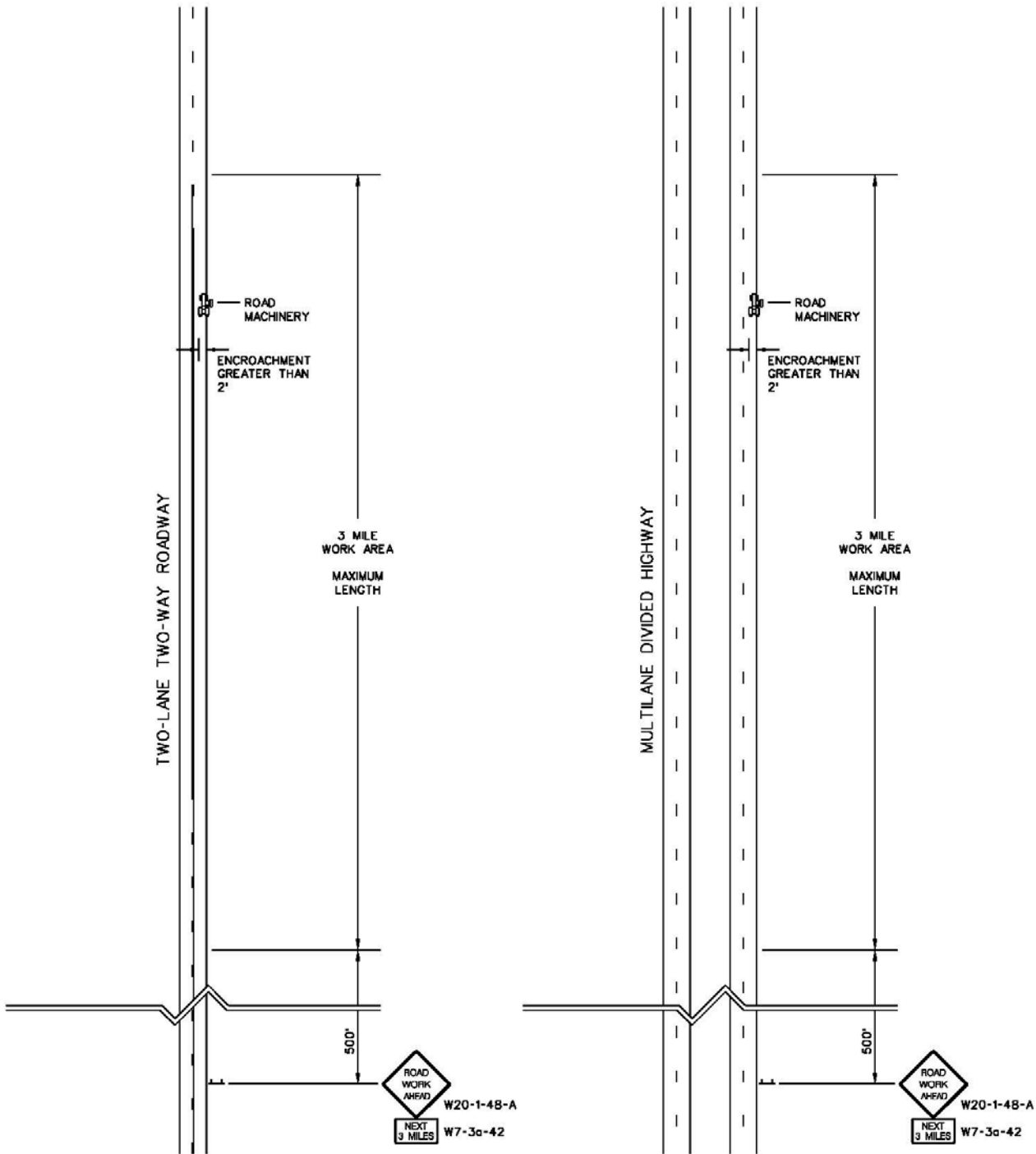

**MOBILIZED SHOULDER OPERATIONS
INTERMEDIATE SPEED TO HIGH SPEED
40 MPH - 60 MPH
PEDESTRIAN WORKERS - MAJOR ENCROACHMENT
ROAD MACHINERY - MAJOR ENCROACHMENT
MULTILANE
PRIMARY & SECONDARY ROUTES**

1. These mobilized shoulder operations are short duration shoulder area work zones with pedestrian workers and a work vehicle or a road machinery unit and a primary shadow vehicle that slowly progresses along the roadway while conducting the work activities. This work zone traffic control setup will permit the pedestrian workers to encroach upon the adjacent travel lane up to but no more than 2 feet. The shadow vehicle and work vehicle or road machinery unit will operate in the adjacent travel lane.
2. **When the pedestrian workers are required to encroach upon the adjacent travel more than 2 feet to perform the work activities, lane closures are required.**
3. Operate the primary shadow vehicle in the travel lane adjacent to the shoulder work area and remain adjacent to the shoulder work area at all times. The driver should maintain visibility of the pedestrian workers. Do not allow the pedestrian workers to advance more than approximately 100 feet beyond the front bumper of the primary shadow vehicle. Operate the primary shadow vehicle close to the near edge of the shoulder work area.
4. Provide and utilize a secondary shadow vehicle when the stopping sight distance between the primary shadow vehicle and an approaching motorist is unavailable based upon the posted regulatory speed limit.
5. Supplement the primary shadow vehicle with a truck mounted advance warning arrow panel displaying a flashing arrow and a truck mounted attenuator.
6. Supplement the secondary shadow vehicle with a truck mounted advance warning arrow panel displaying a flashing arrow and a truck mounted attenuator.
7. Supplement all vehicles and road machinery with amber colored auxiliary warning lights. The auxiliary warning lights shall be high intensity rotating, flashing, oscillating or strobe lights. Standard vehicle hazard warning lights are only permitted as a supplement to the auxiliary warning lights.
8. Maintain two-way radio communication between all vehicles when more than 1 vehicle is utilized.

DRAWING 525-04
 MOBILIZED SHOULDER OPERATIONS
 INTERMEDIATE SPEED TO HIGH SPEED
 40 MPH - 60 MPH

PEDESTRIAN WORKERS - MINOR ENCROACHMENT
 ROAD MACHINERY - MAJOR ENCROACHMENT
 MULTILANE
 PRIMARY & SECONDARY ROUTES

* THE PEDESTRIAN WORKER(S) MAY ENTER THIS AREA FOR BRIEF MOMENTS WHEN NECESSARY TO PLACE ITEMS INTO THE BED OF THE TRUCK *

** THE SIGN PLACEMENT AND RELOCATION REQUIREMENTS DEPEND UPON THE PROGRESSION RATE OF THE WORK ACTIVITIES. AN INITIAL INSTALLATION SPACING INTERVAL OF 500 FEET IS RECOMMENDED. AS THE WORK AREA PROGRESSES, RELOCATE AND RESET THE ADVANCE SIGNING SCHEME TO THE INITIAL INSTALLATION SPACING INTERVAL OF 500 FEET AS NECESSARY TO ENSURE THE INSTALLATION SPACING INTERVAL BETWEEN THE NEAR LIMITS OF THE WORK AREA AND THE "WORKER" SYMBOL" SIGN (W21-1-48) DOES NOT EXCEED 2500 FEET.

*** STOPPING SIGHT DISTANCE REQUIREMENTS ***

POSTED REGULATORY SPEED LIMIT (A)	PASSENGER CAR DISTANCE (X)	TRUCK DISTANCE (X)	SHADOW VEHICLE to WORK VEHICLE MINIMUM DISTANCE (Y)
40 MPH to 55 MPH	500 FEET	750 FEET	75 FEET

CONSIDER USING THE DISTANCES DESIGNATED AS "TRUCK" ON ROADWAYS WITH HIGH TRUCK VOLUMES
 (A) - POSTED REGULATORY SPEED LIMIT
 (X) - STOPPING SIGHT DISTANCE INTERVAL
 (Y) - RECOMMENDED MINIMUM DISTANCE INTERVAL BETWEEN SHADOW VEHICLE AND WORK VEHICLE OR PEDESTRIAN WORKERS WHEN PEDESTRIAN WORKERS ARE PRESENT

PRIMARY SHADOW VEHICLE

AMBER COLORED HIGH INTENSITY ROTATING, FLASHING, OSCILLATING STROBE LIGHTS ARE REQUIRED ON THE PRIMARY SHADOW VEHICLE. VEHICLE WARNING LIGHTS ARE ONLY PERMITTED AS A SUPPLEMENT TO THESE DEVICES.

A TRUCK MOUNTED ADVANCE WARNING ARROW PANEL DISPLAYING A FLASHING ARROW IS REQUIRED ON THE PRIMARY SHADOW VEHICLE.



A TRUCK MOUNTED ATTENUATOR IS REQUIRED ON THE PRIMARY SHADOW VEHICLE.

OPERATE THE PRIMARY SHADOW VEHICLE IN THE TRAVEL LANE ADJACENT TO THE SHOULDER WORK AREA AND REMAIN ADJACENT TO THE SHOULDER WORK AREA AS ILLUSTRATED. THE DRIVER SHOULD MAINTAIN VISIBILITY OF THE PEDESTRIAN WORKER(S). DO NOT ALLOW THE PEDESTRIAN WORKER(S) TO ADVANCE MORE THAN APPROXIMATELY 100 FEET BEYOND THE FRONT BUMPER OF THE PRIMARY SHADOW VEHICLE. OPERATE THE PRIMARY SHADOW VEHICLE CLOSE TO THE NEAR EDGE OF THE SHOULDER WORK AREA.

SECONDARY SHADOW VEHICLE ***

AMBER COLORED HIGH INTENSITY ROTATING, FLASHING, OSCILLATING STROBE LIGHTS ARE REQUIRED ON THE SECONDARY SHADOW VEHICLE. VEHICLE WARNING LIGHTS ARE ONLY PERMITTED AS A SUPPLEMENT TO THESE DEVICES.

A TRUCK MOUNTED ADVANCE WARNING ARROW PANEL DISPLAYING A FLASHING ARROW IS REQUIRED ON THE SECONDARY SHADOW VEHICLE.



A TRUCK MOUNTED ATTENUATOR IS REQUIRED ON THE SECONDARY SHADOW VEHICLE.

PROVIDE AND OPERATE THE SECONDARY SHADOW VEHICLE IN ACCORDANCE WITH THE STOPPING SIGHT DISTANCE REQUIREMENTS. SEE THE "STOPPING SIGHT DISTANCE REQUIREMENTS" CHART ABOVE.

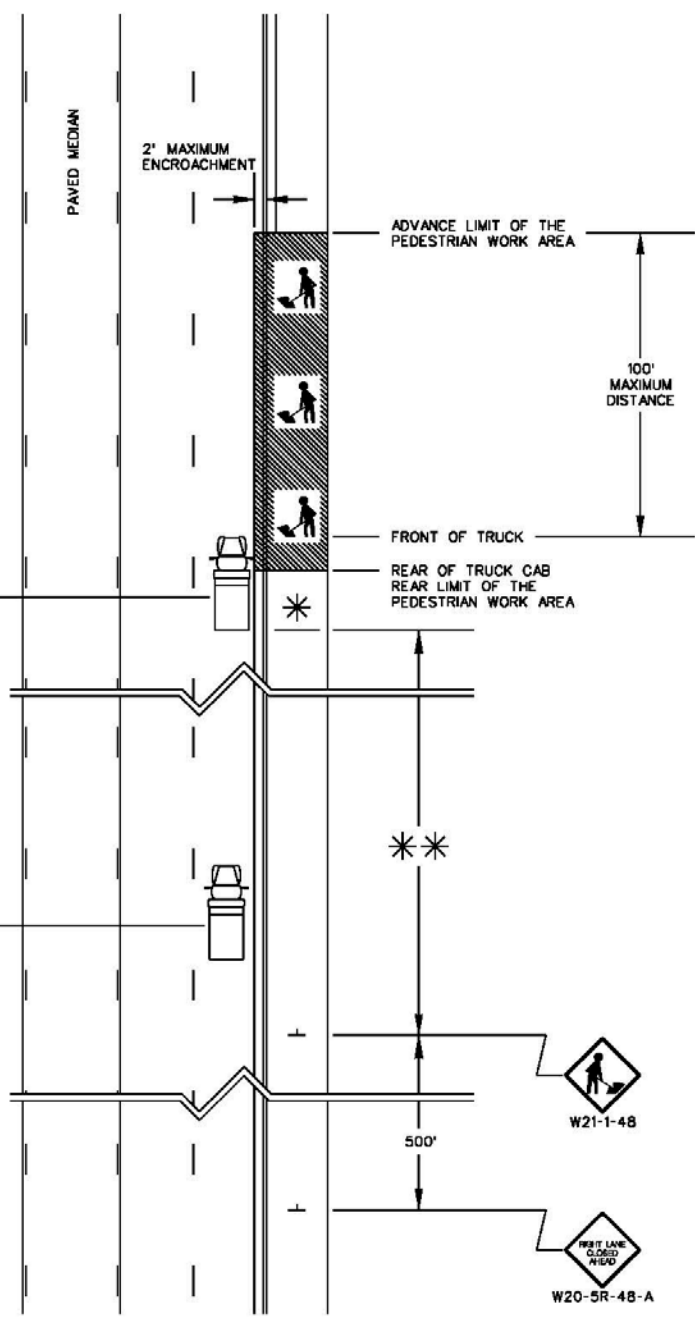

MOBILIZED SHOULDER OPERATIONS

***INTERSTATE
ROUTES***

STANDARD DRAWING NO. 530-01

Through

STANDARD DRAWING NO. 530-03

**MOBILIZED SHOULDER OPERATIONS
ROAD MACHINERY - MAJOR ENCROACHMENT
INTERSTATE ROUTES**

1. Mobilized shoulder operations are short duration work zones involving road machinery that slowly progress along the roadway while conducting work activities within the roadway shoulders. Equipment for these operations occupies the shoulder while continuously moving. **Brief periodic encroachments upon the adjacent travel lane for the equipment to relocate or bypass structures such as guardrail locations or bridge structures are acceptable.**

2. Utilize advance warning signs relative to the type of work activity being conducted. The various types of advance warning sign assemblies that may be utilized shall include the "Mowing" sign (W21-9-48) supplemented with the supplemental sign "Next 3 Miles" (W7-3a-42) for grass mowing operations.

Due to the mobility of these operations, minimum traffic control requirements specify installation of advance warning sign assemblies for each approach that may be impacted by the work activities. Install an advance warning sign assembly on the shoulder the work is being performed in. Relocate these advance warning sign assemblies as necessary as the work area is advanced along the roadway.

Additional traffic control devices relative to the site condition may be utilized, i.e. truck mounted changeable message signs.

3. This traffic control setup applies to a short duration work zone that involves road machinery slowly progressing along the roadway. The most common work activity performed under this traffic control setup is a grass mowing operation.

DRAWING 530-01
 MOBILIZED SHOULDER OPERATIONS
 ROAD MACHINERY - MAJOR ENCROACHMENT
 INTERSTATE ROUTES

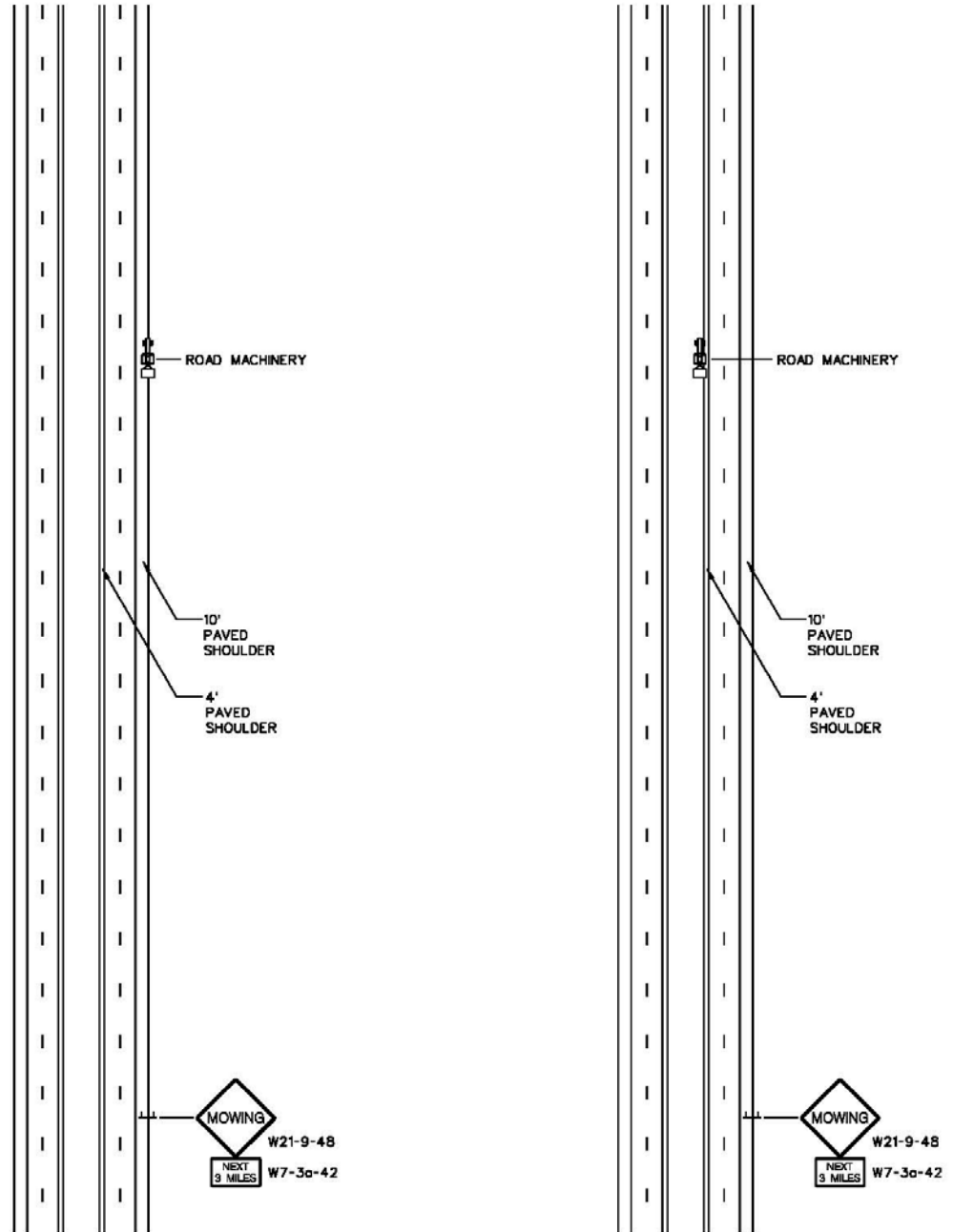

GENERAL NOTE

UTILIZE ADVANCE WARNING SIGNING RELATIVE TO THE TYPE OF WORK ACTIVITY BEING CONDUCTED. THE VARIOUS TYPES OF ADVANCE WARNING SIGN ASSEMBLIES THAT MAY BE UTILIZED SHALL INCLUDE THE "MOWING" SIGN (W21-9-48) SUPPLEMENTED WITH THE SUPPLEMENTAL SIGN "NEXT 3 MILES" (W7-3a-42) FOR GRASS MOWING OPERATIONS. THE SIGN ASSEMBLIES ILLUSTRATED ARE TYPICAL AND MAY BE SUBSTITUTED WITH SIGNS APPROPRIATE TO THE TYPE OF WORK ACTIVITY BEING PERFORMED UNDER THIS TRAFFIC CONTROL SETUP.

**MOBILIZED SHOULDER OPERATIONS
PEDESTRIAN WORKERS - MINOR ENCROACHMENT UPON PAVED SHOULDER
INTERSTATE ROUTES**

1. Mobilized shoulder operations are short duration work zones involving pedestrian workers that slowly progress along the roadway while conducting work activities within a limited area of a roadway shoulder. These mobilized shoulder operations include pedestrian workers and a work vehicle and may also include work equipment. The pedestrian workers may encroach upon the paved shoulders up to 2 feet. Pedestrian workers are PROHIBITED from encroaching upon a paved shoulder by more than 2 feet. The work vehicle should avoid encroachment upon the paved shoulder by more than 2 feet where sufficient earth shoulder is available. **Brief periodic encroachments upon the adjacent paved shoulder greater than 2 feet for the work vehicle to relocate or bypass structures such as guardrail locations or bridge structures are acceptable.**

2. Standard stationary lane closures are required for these work activities when pedestrian workers are required to encroach upon the paved shoulders more than 2 feet.

3. A work vehicle shall accompany the pedestrian workers as illustrated at all times when pedestrian workers are within 30 feet or less of an adjacent travel lane. The work vehicle shall remain within 100 feet of the work location for the pedestrian workers at all times. **Supplement the work vehicle with amber colored auxiliary warning lights. The auxiliary warning lights shall be high intensity rotating, flashing, oscillating or strobe lights. Standard vehicle hazard warning lights are only permitted as a supplement to the auxiliary warning lights.**

4. Utilize advance warning signs relative to the type of work activity being conducted. The "Worker" sign (W21-1-48) is required when pedestrian workers are present. The "Worker" sign (W21-1-48) may be installed in addition to those signs relative to work activities that may not require pedestrian workers. For example, the "Worker" sign (W21-1-48) may be installed in addition to the "Mowing" sign (W21-9-48) when appropriate.

Due to the mobility of these operations and the minor encroachment onto the adjacent paved shoulder, minimum traffic control requirements specify installation of advance warning sign assemblies and an accompanying work vehicle for each approach that may be impacted by the work activities. Install an advance warning sign assembly on the shoulder the work is being performed in. Relocate these advance warning sign assemblies as necessary as the work area is advanced along the roadway.

Additional traffic control devices relative to the site condition may be utilized, i.e. truck mounted changeable message signs.

5. Whenever a shoulder closure is required, supplement the shoulder closure advance warning sign array with an advance warning sign assembly appropriate to the type of work activity being conducted. Install this supplemental advance warning sign in advance of the shoulder closure advance warning sign array at an interval spacing appropriate to the posted regulatory speed as prescribed by this manual.

6. This traffic control setup applies to a short duration work zone within a defined area of the shoulders of an interstate route that includes pedestrian workers and slowly progresses along the roadway. The most common work activity performed under this traffic control setup is a hand trimming operation performed during grass mowing operations.

DRAWING 530-02
 MOBILIZED SHOULDER OPERATIONS
 PEDESTRIAN WORKERS - MINOR ENCROACHMENT
 UPON PAVED SHOULDER
 INTERSTATE ROUTES

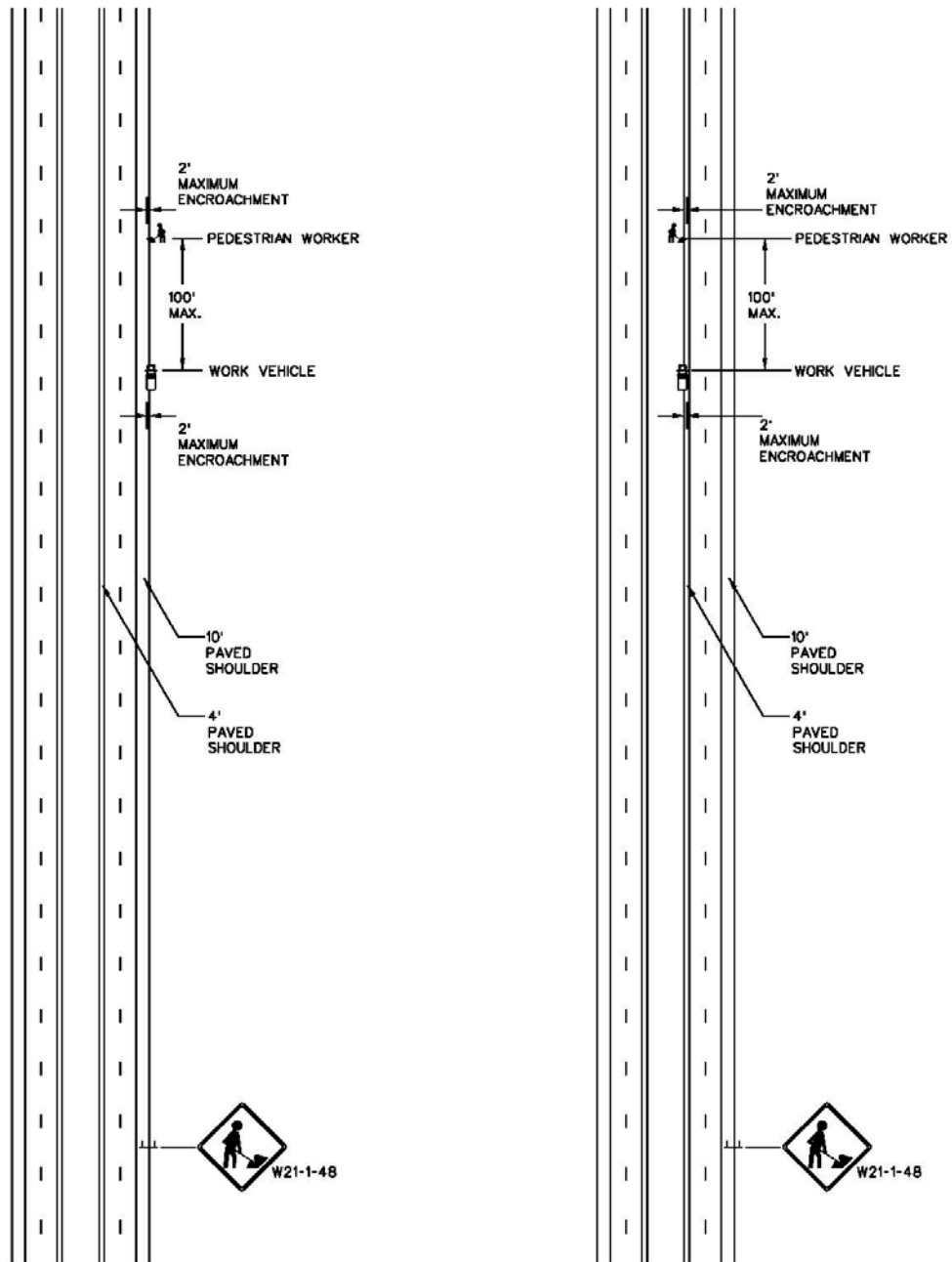

GENERAL NOTE

UTILIZE ADVANCE WARNING SIGNING RELATIVE TO THE TYPE OF WORK ACTIVITY BEING CONDUCTED. THE SIGN ASSEMBLIES ILLUSTRATED ARE TYPICAL. THE "WORKER" SIGN (W21-1-48) IS REQUIRED WHEN PEDESTRIAN WORKERS ARE PRESENT. THE "WORKER" SIGN (W21-1-48) MAY BE INSTALLED IN ADDITION TO THOSE SIGNS RELATIVE TO WORK ACTIVITIES THAT MAY NOT REQUIRE PEDESTRIAN WORKERS, FOR EXAMPLE, THE "WORKER" SIGN (W21-1-48) MAY BE INSTALLED IN ADDITION TO THE "MOWING" SIGN (W21-9-48) WHEN APPROPRIATE.

**MOBILIZED SHOULDER OPERATIONS
PEDESTRIAN WORKERS - MAJOR ENCROACHMENT UPON PAVED SHOULDER
ROAD MACHINERY - MAJOR ENCROACHMENT UPON TRAVEL LANE
INTERSTATE ROUTES**

1. Mobilized shoulder operations with pedestrian workers (major encroachment) are short duration work zones that slowly progress along the roadway while work activities involving pedestrian workers are conducted within a defined area of a roadway shoulder that adjoins the near edge of an adjacent travel lane. These mobilized shoulder operations with pedestrian workers may also include work equipment and vehicles. Each pedestrian worker should remain within the shoulder area and avoid encroachment upon the adjacent travel lane. Work equipment, accompanied by a shadow vehicle, may encroach upon the adjacent travel lane as necessary.

2. Standard stationary lane closures are required for shoulder area work activities that require a pedestrian worker to encroach upon an adjacent travel lane.

3. The Resident Engineer may request the assistance of law enforcement when pedestrian workers are present and performing work operations in the shoulder area of an interstate route.

4. A pedestrian work area within the paved shoulder has defined limits within which the pedestrian worker may conduct prescribed work activities. The forward limits of the pedestrian work area should not extend beyond approximately 25 feet forward of the front bumper of the shadow vehicle operating in the adjacent travel lane. The rear limits of the pedestrian work area should be maintained from directly adjacent to the rear of the truck cab forward to those forward limits as defined above. The lateral limit of the pedestrian work area the pedestrian worker should not cross is the longitudinal boundary between the adjacent travel lane and the paved shoulder.

The drivers of the shadow vehicles should be aware of the pedestrian worker(s) location(s) at all times. Brief moments of sight restrictions between the driver and the pedestrian worker are permissible in the event the pedestrian worker must place items into the bed of the Travel Lane Shadow Vehicle from the shoulder area without encroaching into the travel lane.

5. Shadow vehicles shall accompany the pedestrian workers as illustrated at all times when the pedestrian workers must conduct work activities within the shoulder area immediately adjacent to the near edge of the adjacent travel lane. These operations shall include two (2) types of shadow vehicles.

Shoulder Shadow Vehicle - The initial shadow vehicle encountered by approaching motorists. This shadow vehicle shall operate in the paved shoulder to minimize access by errant vehicles into the shoulder work area where pedestrian workers are present. Operate this vehicle in the paved shoulder area. Maintain approximately 100 feet between the Shoulder Shadow Vehicle and the first Travel Lane Shadow Vehicle operating in the adjacent travel lane.

Travel Lane Shadow Vehicle - The subsequent shadow vehicle(s) operating in the travel lane immediately adjacent to the shoulder area where pedestrian workers are present to minimize access by errant vehicles into the shoulder work area laterally from an adjacent travel lane. This vehicle should operate as close to the near edge of the shoulder as feasible when necessary for the pedestrian worker to place items into the bed of the shadow vehicle.

6. **Supplement each shadow vehicle with a truck mounted advance warning arrow panel operating in a flashing arrow mode. Also, supplement each work vehicle with amber colored auxiliary warning lights. The auxiliary warning lights shall be high intensity rotating, flashing, oscillating or strobe lights. Standard vehicle hazard warning lights are only permitted as a supplement to the auxiliary warning lights.**

7. Maintain two-way radio communication between all vehicles when more than 1 vehicle is utilized.

8. Utilize advance warning signs relative to the work zone site conditions. The "Worker" sign (W21-1-48) is required when pedestrian workers are present. Install a "Right (Left) Lane Closed Ahead" sign (W20-5R(L)-48-A) followed by the "Worker" sign (W21-1-48).

Due to the mobility of these operations, minimum traffic control requirements specify the installation of advance warning sign assemblies and the accompanying shadow vehicle(s). Install advance warning sign assemblies on the same shoulder the work is being performed in. Relocate these advance warning sign assemblies or install additional advance warning sign assemblies as necessary as the work area advances along the roadway. Do not allow the work train to advance beyond a one (1) mile increment from the prescribed advance warning sign assemblies at any time.

Additional traffic control devices relative to the site condition may be utilized, i.e. truck mounted changeable message signs.

9. **On interstate routes, the minimum mounting height of the advance warning signs mounted on portable sign supports is 5 feet from the ground to the bottom edge of the sign.**

10. This traffic control setup applies to a short duration work zone within the paved shoulders of an interstate route that includes pedestrian workers and slowly progresses along the roadway.

* THE PEDESTRIAN WORKER(S) MAY ENTER THIS AREA FOR BRIEF MOMENTS WHEN NECESSARY TO PLACE ITEMS INTO THE BED OF THE TRUCK *

DRAWING 530-03
 MOBILIZED SHOULDER OPERATIONS
 PEDESTRIAN WORKERS - MAJOR ENCROACHMENT
 UPON PAVED SHOULDER
 ROAD MACHINERY - MAJOR ENCROACHMENT
 UPON TRAVEL LANE
 INTERSTATE ROUTES

TRAVEL LANE
 SHADOW VEHICLE

A TRUCK MOUNTED ATTENUATOR AND AN ADVANCE WARNING ARROW PANEL ARE REQUIRED ON THIS VEHICLE. THE ADVANCE WARNING ARROW PANEL SHALL OPERATE IN THE FLASHING ARROW MODE.

OPERATE THE TRAVEL LANE SHADOW VEHICLE IN THE TRAVEL LANE ADJACENT TO THE SHOULDER WORK AREA AND REMAIN ADJACENT TO THE SHOULDER WORK AREA AS ILLUSTRATED. THE DRIVER SHOULD MAINTAIN VISIBILITY OF THE PEDESTRIAN WORKER(S). DO NOT ALLOW THE PEDESTRIAN WORKER(S) TO ADVANCE MORE THAN APPROXIMATELY 25 FEET BEYOND THE FRONT BUMPER OF THE VEHICLE. OPERATE THIS VEHICLE CLOSE TO NEAR EDGE OF THE SHOULDER AREA.

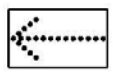

TRAVEL LANE
 SHADOW VEHICLE

A TRUCK MOUNTED ATTENUATOR AND AN ADVANCE WARNING ARROW PANEL ARE REQUIRED ON THIS VEHICLE. THE ADVANCE WARNING ARROW PANEL SHALL OPERATE IN THE FLASHING ARROW MODE.

OPERATE THE TRAVEL LANE SHADOW VEHICLE IN THE TRAVEL LANE ADJACENT TO THE SHOULDER WORK AREA AND REMAIN ADJACENT TO THE SHOULDER WORK AREA AS ILLUSTRATED. THE DRIVER SHOULD MAINTAIN VISIBILITY OF THE PEDESTRIAN WORKER(S). DO NOT ALLOW THE PEDESTRIAN WORKER(S) TO ADVANCE MORE THAN APPROXIMATELY 25 FEET BEYOND THE FRONT BUMPER OF THE VEHICLE. OPERATE THIS VEHICLE CLOSE TO NEAR EDGE OF THE SHOULDER AREA.

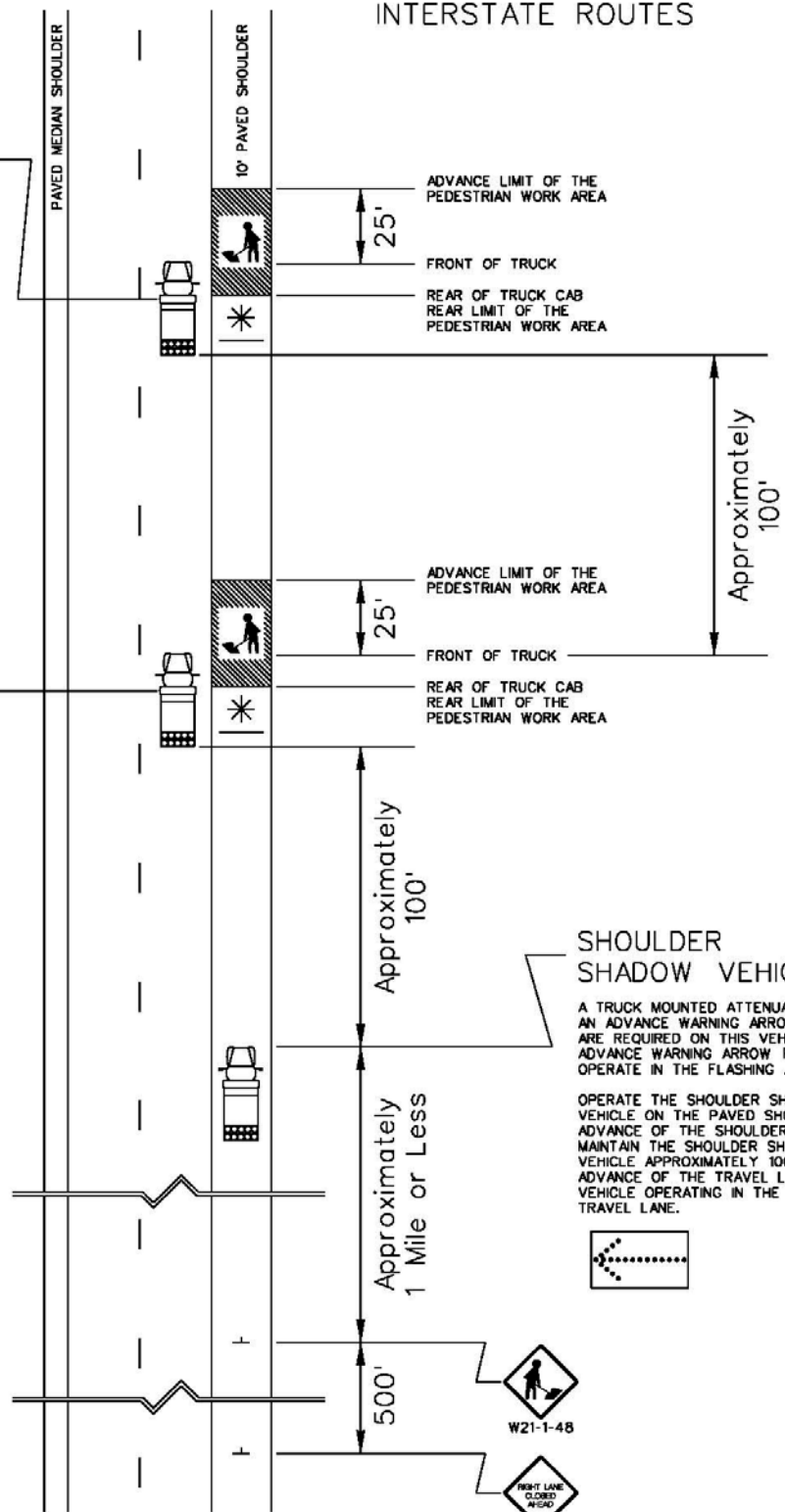
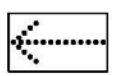

SHOULDER
 SHADOW VEHICLE

A TRUCK MOUNTED ATTENUATOR AND AN ADVANCE WARNING ARROW PANEL ARE REQUIRED ON THIS VEHICLE. THE ADVANCE WARNING ARROW PANEL SHALL OPERATE IN THE FLASHING ARROW MODE.

OPERATE THE SHOULDER SHADOW VEHICLE ON THE PAVED SHOULDER IN ADVANCE OF THE SHOULDER WORK AREA. MAINTAIN THE SHOULDER SHADOW VEHICLE APPROXIMATELY 100 FEET IN ADVANCE OF THE TRAVEL LANE SHADOW VEHICLE OPERATING IN THE ADJACENT TRAVEL LANE.

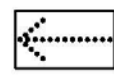

MOBILE OPERATIONS

INTERMITTENT

STANDARD DRAWING NO. 535-01-A

Through

STANDARD DRAWING NO. 535-04-E

**MOBILE OPERATIONS
INTERMITTENT
STOPPING SIGHT DISTANCE
VEHICLE TRAIN REQUIREMENTS
VERTICAL CURVE (HILL) / HORIZONTAL CURVE (CURVE)**

1. Intermittent mobile operations are mobile operations that move at speeds less than 3 mph or involve frequent short stops.
2. Intermittent mobile operations may be performed by a single work vehicle or a vehicle train. A single work vehicle may be a car or truck type vehicle or a single piece of equipment. A vehicle train operating under the requirements of an intermittent mobile operation typically includes no more than 2 (two) vehicles to include either 1 (one) work vehicle or 1 (one) piece of equipment and a shadow vehicle. However, multiple shadow vehicles may be utilized when deemed necessary by the RME or the RME's designated representative.
3. Roadway characteristics such as type, speed classification and volume classification determine the traffic control requirements for intermittent mobile operations.
4. Evaluate the available stopping sight distance at each work location prior to implementing an intermittent mobile operation.

Stopping Sight Distance: **The length of roadway necessary for a typical vehicle to stop before reaching a stationary object in its path.**

The stopping sight distance interval for any specific location is determined by the **posted regulatory speed limit** of the roadway. For the stopping sight distance, see *Table 11, Stopping Sight Distance*.

5. Consideration for utilizing a shadow vehicle during daytime hours is based upon the availability of adequate stopping sight distance. A shadow vehicle should accompany the work vehicle when the distance interval between the location point at which an approaching prudent driver is first able to recognize the presence of the work vehicle and the location of the work vehicle is less than the numerical figure indicated for sufficient stopping sight distance. **When a shadow vehicle is utilized, position the shadow vehicle to maintain adequate stopping sight distance between the shadow vehicle and approaching motorists. Field adjustments to the location of the shadow vehicle may be necessary to ensure the shadow vehicle is not positioned in a location that may create a hazardous situation due to limited stopping sight distance in regard to a prudent driver being able to recognize the presence of the shadow vehicle.**

The distance between the work vehicle and the shadow vehicle is determined by the **posted regulatory speed limit** of the roadway; see *Table 15, Shadow Vehicle / Work Vehicle Intervals*. Consider these distance intervals between the shadow vehicle and the work vehicle in accordance with the **posted regulatory speed limit** of the roadway where the work is being conducted.

Table 15 Shadow Vehicle / Work Vehicle Distance Intervals

POSTED REGULATORY SPEED LIMIT	DISTANCE INTERVAL
35 MPH or Less	50 Feet – 250 Feet
40 - 50 MPH	75 Feet – 500 Feet
55 MPH or Greater	100 Feet – 750 Feet

6. A shadow vehicle is **REQUIRED** during **ALL** intermittent mobile operations conducted during the hours of darkness.

7. Roadway characteristics determine the vehicle train requirements for an intermittent mobile operation. Evaluate the potential sight distance restrictions, such as vertical and horizontal curves, and the posted regulatory speed limits prior to deployment of a work detail to determine the minimum vehicle train requirements.

Single Work Vehicle / Vehicle Train Requirements

Single Work Vehicle:

A single work vehicle is permitted in locations where the stopping sight distance interval between the work vehicle and an approaching motorist is available based upon the posted regulatory speed limit of the specific location.

When a sufficient stopping sight distance interval is not available, a shadow vehicle may be required. See "Vehicle Train" below for the requirements regarding a shadow vehicle and the work vehicle.

Shadow Vehicle:

LOW VOLUME / LOW SPEED ROADWAYS -

Shadow vehicles may be OPTIONAL provided the work vehicle / equipment is equipped with AMBER or YELLOW colored high intensity rotating, flashing, oscillating or strobe auxiliary warning lights.

LOW VOLUME / INTERMEDIATE TO HIGH SPEED ROADWAYS - INTERMEDIATE TO HIGH VOLUME / LOW TO HIGH SPEED ROADWAYS -

A vehicle train consisting of a work vehicle and a shadow vehicle is required in locations where the stopping sight distance interval between the work vehicle and an approaching motorist is unavailable based upon the posted regulatory speed limit of the specific location.

PRIMARY AND SECONDARY ROUTES -

The distance interval from the shadow vehicle to the work vehicle may vary from a minimum 50 feet up to but not more than the stopping sight distance interval based upon the posted regulatory speed limit of the specific location.

INTERSTATE ROUTES -

The distance interval from the shadow vehicle to the work vehicle may vary from 100 feet up to but not more than the stopping sight distance interval based upon the posted regulatory speed limit of the specific location.

8. Maintain two-way radio communication between all vehicles when more than 1 vehicle is utilized.

9. Supplement all vehicles operating in the vehicle train with amber colored auxiliary warning lights. The auxiliary warning lights shall be high intensity rotating, flashing, oscillating or strobe lights. Standard vehicle hazard warning lights are only permitted as a supplement to the auxiliary warning lights.

10. When a Single Work Vehicle is utilized, the minimum vehicle lighting equipment requirement is to supplement the vehicle with an amber colored auxiliary warning light(s) mounted on top of the vehicle.

On **TWO-LANE TWO-WAY ROADWAYS**, the Single Work Vehicle may also be supplemented with a truck mounted advance warning arrow panel operating in the "Four Corner" Caution Mode with one lamp in each corner.

On **MULTILANE ROADWAYS**, the Single Work Vehicle may be supplemented with a truck mounted advance warning arrow panel operating in in a Flashing Arrow Mode or a Sequential Chevron Mode.

11. When a Vehicle Train including a Work Vehicle and a Shadow Vehicle is utilized, the minimum vehicle lighting equipment requirement for each vehicle is to supplement each vehicle with an amber colored auxiliary warning light(s) mounted on top of the vehicles.

On **TWO-LANE TWO-WAY ROADWAYS**, either or both the Work Vehicle and the Shadow Vehicle, may be supplemented with a truck mounted advance warning arrow panel operating in the "Four Corner" Caution Mode with one lamp in each corner.

On **MULTILANE ROADWAYS**, supplement no less than **ONE** of the vehicles in the Vehicle Train with a truck mounted advance warning arrow panel operating in a Flashing Arrow Mode or a Sequential Chevron Mode. A truck mounted advance warning arrow panel is recommended but not required on the Work Vehicle. However, if the Work Vehicle is NOT supplemented with an advance warning arrow panel, then an advance warning arrow panel operating in a Flashing Arrow Mode or a Sequential Chevron Mode is REQUIRED on the Shadow Vehicle.

GENERAL NOTES:

1. STOPPING SIGHT DISTANCE IS THE LENGTH OF ROADWAY NECESSARY FOR A VEHICLE TO STOP BEFORE REACHING A STATIONARY OBJECT OR SPECIFIC LOCATION IN ITS PATH.
2. UTILIZE A SHADOW VEHICLE TO ACCOMPANY THE WORK VEHICLE WHEN THE STOPPING SIGHT DISTANCE BETWEEN THE WORK VEHICLE AND AN APPROACHING MOTORIST IS UNAVAILABLE BASED UPON THE POSTED REGULATORY SPEED LIMIT.
3. WHEN UTILIZING A SHADOW VEHICLE, LOCATE THE SHADOW VEHICLE TO PROVIDE SUFFICIENT STOPPING SIGHT DISTANCE BETWEEN AN APPROACHING MOTORIST AND THE SHADOW VEHICLE.
4. THE WORK VEHICLE AND THE SHADOW VEHICLE SHOULD UTILIZE AND REMAIN WITHIN THE SHOULDER AREA AS MUCH AS PRACTICAL.
5. A SHADOW VEHICLE IS REQUIRED DURING ALL INTERMITTENT MOBILE OPERATIONS CONDUCTED DURING THE HOURS OF DARKNESS.

PRIMARY AND SECONDARY ROUTES -

6. THE MAXIMUM TIME DURATION OF A STOP IS 15 MINUTES IF THE WORK VEHICLE AND/OR THE SHADOW VEHICLE MUST ENCR OACH UPON A TRAVEL LANE MORE THAN 2 FEET.
7. THE MAXIMUM TIME DURATION OF A STOP IS 30 MINUTES IF THE WORK VEHICLE AND/OR THE SHADOW VEHICLE REMAIN IN THE SHOULDER AREA IN THEIR ENTIRETY OR ENCR OACHES UPON A TRAVEL LANE NO MORE THAN 2 FEET.
8. A SHADOW VEHICLE MAY NOT BE NECESSARY DURING DAYTIME OPERATIONS WHEN ADEQUATE SIGHT DISTANCE IS AVAILABLE.

INTERSTATE ROUTES -

9. UNLESS OTHERWISE SPECIFICALLY DIRECTED BY THIS MANUAL, THE MAXIMUM TIME DURATION OF A STOP IS 5 MINUTES WHEN THE WORK VEHICLE AND/OR THE SHADOW VEHICLE MUST ENCR OACH UPON A TRAVEL LANE DUE TO A SHOULDER AREA INADEQUATE TO ACCOMMODATE A VEHICLE IN ITS ENTIRETY DUE TO THE PRESENCE OF A CONCRETE MEDIAN BARRIER WALL, A BRIDGE PARAPET WALL OR GUARDRAIL.
10. THE MAXIMUM TIME DURATION OF A STOP IS 30 MINUTES IF ALL VEHICLES REMAIN IN THE SHOULDER AREA IN THEIR ENTIRETY WITH NO ENCR OACHMENT UPON THE ADJACENT TRAVEL LANE.
11. A SHADOW VEHICLE MAY NOT BE NECESSARY DURING DAYTIME OPERATIONS WHEN THE WORK VEHICLE REMAINS WITHIN THE SHOULDER AREA IN ITS ENTIRETY AND ADEQUATE SIGHT DISTANCE IS AVAILABLE.
12. ENCR OACHMENT UPON A TRAVEL LANE BY THE WORK VEHICLE WITHOUT A SHADOW VEHICLE IS UNACCEPTABLE UNLESS OTHERWISE DIRECTED BY THIS MANUAL.

**DRAWING 535-01-A
MOBILE OPERATIONS
INTERMITTENT
STOPPING SIGHT DISTANCE
VEHICLE TRAIN REQUIREMENTS
VERTICAL CURVE
(HILL)**

STOPPING SIGHT DISTANCE REQUIREMENTS			
POSTED REGULATORY SPEED LIMIT	PASSENGER CAR DISTANCE	TRUCK DISTANCE	SHADOW VEHICLE to WORK VEHICLE DISTANCE
(A)	(X)	(X)	(Y)
≤ 35 MPH	250 FEET	350 FEET	50-250 FEET
40 MPH to 55 MPH	500 FEET	750 FEET	75-500 FEET
60 MPH to 70 MPH	750 FEET	1100 FEET	100-750 FEET

CONSIDER USING THE DISTANCES DESIGNATED AS "TRUCK" ON ROADWAYS WITH HIGH TRUCK VOLUMES
 (A) - POSTED REGULATORY SPEED LIMIT
 (X) - STOPPING SIGHT DISTANCE INTERVAL
 (Y) - RECOMMENDED MINIMUM DISTANCE INTERVAL BETWEEN SHADOW VEHICLE AND WORK VEHICLE OR PEDESTRIAN WORKERS WHEN PEDESTRIAN WORKERS ARE PRESENT

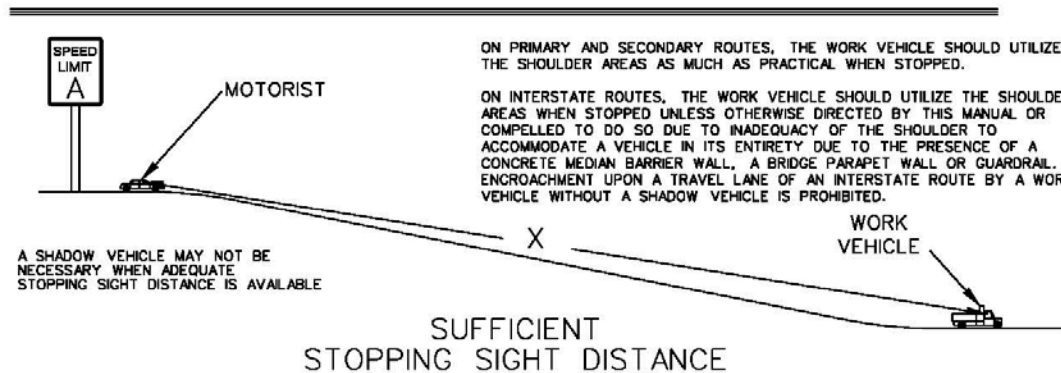

ON PRIMARY AND SECONDARY ROUTES, THE WORK VEHICLE SHOULD UTILIZE THE SHOULDER AREAS AS MUCH AS PRACTICAL WHEN STOPPED.

ON INTERSTATE ROUTES, THE WORK VEHICLE SHOULD UTILIZE THE SHOULDER AREAS WHEN STOPPED UNLESS OTHERWISE DIRECTED BY THIS MANUAL OR COMPELLED TO DO SO DUE TO INADEQUACY OF THE SHOULDER TO ACCOMMODATE A VEHICLE IN ITS ENTIRETY DUE TO THE PRESENCE OF A CONCRETE MEDIAN BARRIER WALL, A BRIDGE PARAPET WALL OR GUARDRAIL. ENCR OACHMENT UPON A TRAVEL LANE OF AN INTERSTATE ROUTE BY A WORK VEHICLE WITHOUT A SHADOW VEHICLE IS PROHIBITED.

A SHADOW VEHICLE MAY NOT BE NECESSARY WHEN ADEQUATE STOPPING SIGHT DISTANCE IS AVAILABLE

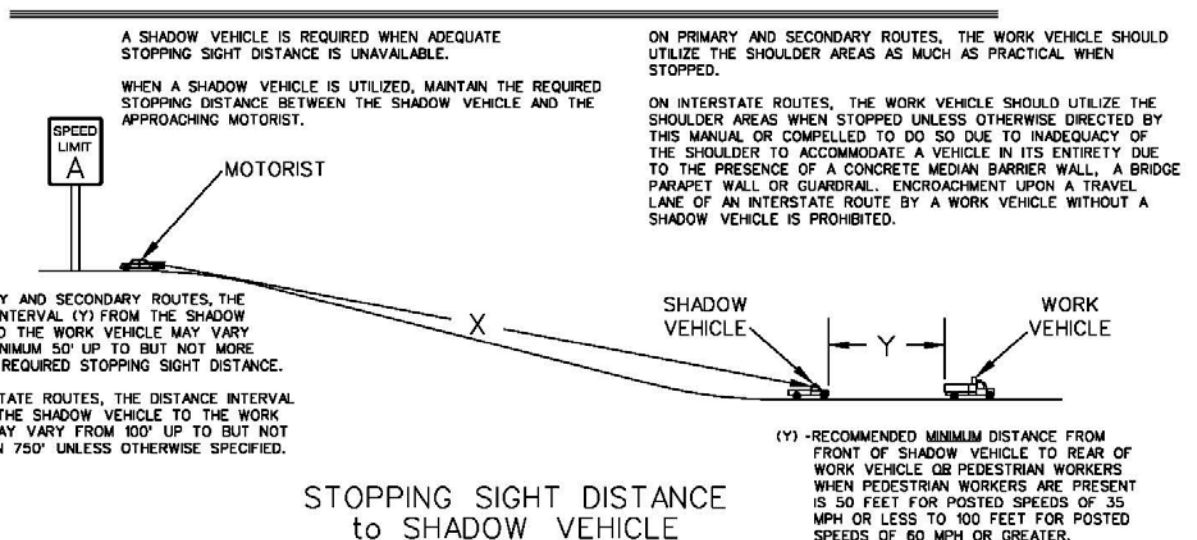

A SHADOW VEHICLE IS REQUIRED WHEN ADEQUATE STOPPING SIGHT DISTANCE IS UNAVAILABLE.

WHEN A SHADOW VEHICLE IS UTILIZED, MAINTAIN THE REQUIRED STOPPING DISTANCE BETWEEN THE SHADOW VEHICLE AND THE APPROACHING MOTORIST.

ON PRIMARY AND SECONDARY ROUTES, THE WORK VEHICLE SHOULD UTILIZE THE SHOULDER AREAS AS MUCH AS PRACTICAL WHEN STOPPED.

ON INTERSTATE ROUTES, THE WORK VEHICLE SHOULD UTILIZE THE SHOULDER AREAS WHEN STOPPED UNLESS OTHERWISE DIRECTED BY THIS MANUAL OR COMPELLED TO DO SO DUE TO INADEQUACY OF THE SHOULDER TO ACCOMMODATE A VEHICLE IN ITS ENTIRETY DUE TO THE PRESENCE OF A CONCRETE MEDIAN BARRIER WALL, A BRIDGE PARAPET WALL OR GUARDRAIL. ENCR OACHMENT UPON A TRAVEL LANE OF AN INTERSTATE ROUTE BY A WORK VEHICLE WITHOUT A SHADOW VEHICLE IS PROHIBITED.

ON PRIMARY AND SECONDARY ROUTES, THE DISTANCE INTERVAL (Y) FROM THE SHADOW VEHICLE TO THE WORK VEHICLE MAY VARY FROM A MINIMUM 50' UP TO BUT NOT MORE THAN THE REQUIRED STOPPING SIGHT DISTANCE.

ON INTERSTATE ROUTES, THE DISTANCE INTERVAL (Y) FROM THE SHADOW VEHICLE TO THE WORK VEHICLE MAY VARY FROM 100' UP TO BUT NOT MORE THAN 750' UNLESS OTHERWISE SPECIFIED.

(Y) - RECOMMENDED MINIMUM DISTANCE FROM FRONT OF SHADOW VEHICLE TO REAR OF WORK VEHICLE OR PEDESTRIAN WORKERS WHEN PEDESTRIAN WORKERS ARE PRESENT IS 50 FEET FOR POSTED SPEEDS OF 35 MPH OR LESS TO 100 FEET FOR POSTED SPEEDS OF 60 MPH OR GREATER.

GENERAL NOTES:

1. STOPPING SIGHT DISTANCE IS THE LENGTH OF ROADWAY NECESSARY FOR A VEHICLE TO STOP BEFORE REACHING A STATIONARY OBJECT OR SPECIFIC LOCATION IN ITS PATH.
2. UTILIZE A SHADOW VEHICLE TO ACCOMPANY THE WORK VEHICLE WHEN THE STOPPING SIGHT DISTANCE BETWEEN THE WORK VEHICLE AND AN APPROACHING MOTORIST IS UNAVAILABLE BASED UPON THE POSTED REGULATORY SPEED LIMIT.
3. WHEN UTILIZING A SHADOW VEHICLE, LOCATE THE SHADOW VEHICLE TO PROVIDE SUFFICIENT STOPPING SIGHT DISTANCE BETWEEN AN APPROACHING MOTORIST AND THE SHADOW VEHICLE.
4. THE WORK VEHICLE AND THE SHADOW VEHICLE SHOULD UTILIZE AND REMAIN WITHIN THE SHOULDER AREA AS MUCH AS PRACTICAL.
5. A SHADOW VEHICLE IS REQUIRED DURING ALL INTERMITTENT MOBILE OPERATIONS CONDUCTED DURING THE HOURS OF DARKNESS.

PRIMARY AND SECONDARY ROUTES -

6. THE MAXIMUM TIME DURATION OF A STOP IS 15 MINUTES IF THE WORK VEHICLE AND/OR THE SHADOW VEHICLE MUST ENCR OACH UPON A TRAVEL LANE MORE THAN 2 FEET.
7. THE MAXIMUM TIME DURATION OF A STOP IS 30 MINUTES IF THE WORK VEHICLE AND/OR THE SHADOW VEHICLE REMAIN IN THE SHOULDER AREA IN THEIR ENTIRETY OR ENCR OACHES UPON A TRAVEL LANE NO MORE THAN 2 FEET.
8. A SHADOW VEHICLE MAY NOT BE NECESSARY DURING DAYTIME OPERATIONS WHEN ADEQUATE SIGHT DISTANCE IS AVAILABLE.

INTERSTATE ROUTES -

9. UNLESS OTHERWISE SPECIFICALLY DIRECTED BY THIS MANUAL, THE MAXIMUM TIME DURATION OF A STOP IS 5 MINUTES WHEN THE WORK VEHICLE AND/OR THE SHADOW VEHICLE MUST ENCR OACH UPON A TRAVEL LANE DUE TO A SHOULDER AREA INADEQUATE TO ACCOMMODATE A VEHICLE IN ITS ENTIRETY DUE TO THE PRESENCE OF A CONCRETE MEDIAN BARRIER WALL, A BRIDGE PARAPET WALL OR GUARDRAIL.
10. THE MAXIMUM TIME DURATION OF A STOP IS 30 MINUTES IF ALL VEHICLES REMAIN IN THE SHOULDER AREA IN THEIR ENTIRETY WITH NO ENCR OACHMENT UPON THE ADJACENT TRAVEL LANE.
11. A SHADOW VEHICLE MAY NOT BE NECESSARY DURING DAYTIME OPERATIONS WHEN THE WORK VEHICLE REMAINS WITHIN THE SHOULDER AREA IN ITS ENTIRETY AND ADEQUATE SIGHT DISTANCE IS AVAILABLE.
12. ENCR OACHMENT UPON A TRAVEL LANE BY THE WORK VEHICLE WITHOUT A SHADOW VEHICLE IS UNACCEPTABLE UNLESS OTHERWISE DIRECTED BY THIS MANUAL.

DRAWING 535-01-B
MOBILE OPERATIONS
INTERMITTENT
STOPPING SIGHT DISTANCE
VEHICLE TRAIN REQUIREMENTS
HORIZONTAL CURVE
(CURVE)

STOPPING SIGHT DISTANCE REQUIREMENTS			
POSTED REGULATORY SPEED LIMIT	PASSENGER CAR DISTANCE	TRUCK DISTANCE	SHADOW VEHICLE to WORK VEHICLE DISTANCE
(A)	(X)	(X)	(Y)
≤ 35 MPH	250 FEET	350 FEET	50-250 FEET
40 MPH to 55 MPH	500 FEET	750 FEET	75-500 FEET
60 MPH to 70 MPH	750 FEET	1100 FEET	100-750 FEET

CONSIDER USING THE DISTANCES DESIGNATED AS "TRUCK" ON ROADWAYS WITH HIGH TRUCK VOLUMES

(A) - POSTED REGULATORY SPEED LIMIT

(X) - STOPPING SIGHT DISTANCE INTERVAL

(Y) - RECOMMENDED MINIMUM DISTANCE INTERVAL BETWEEN SHADOW VEHICLE AND WORK VEHICLE OR PEDESTRIAN WORKERS WHEN PEDESTRIAN WORKERS ARE PRESENT

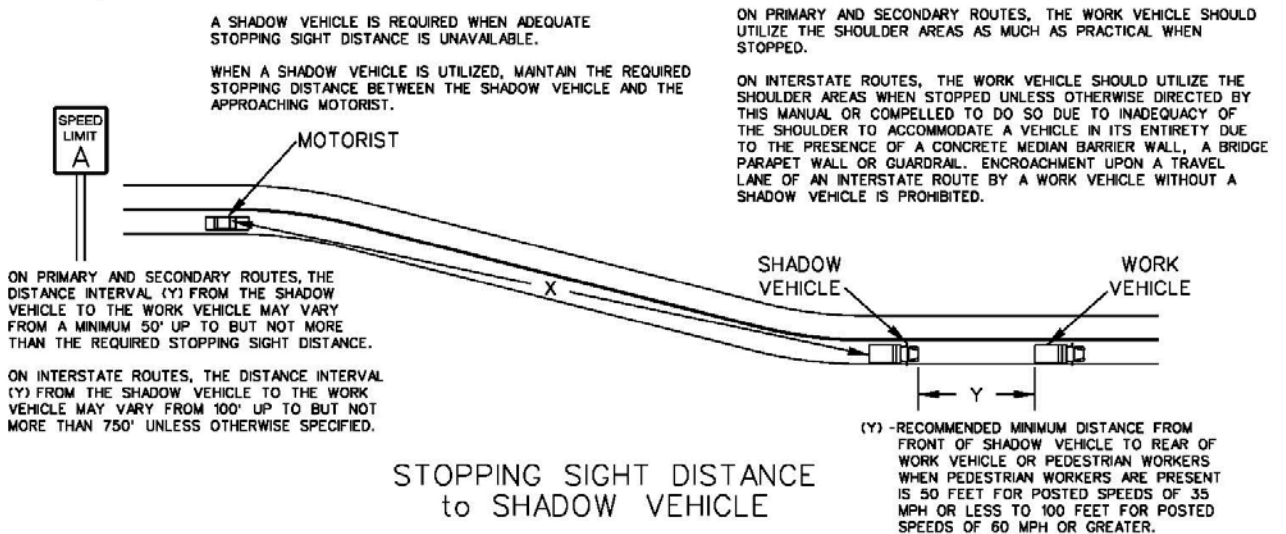
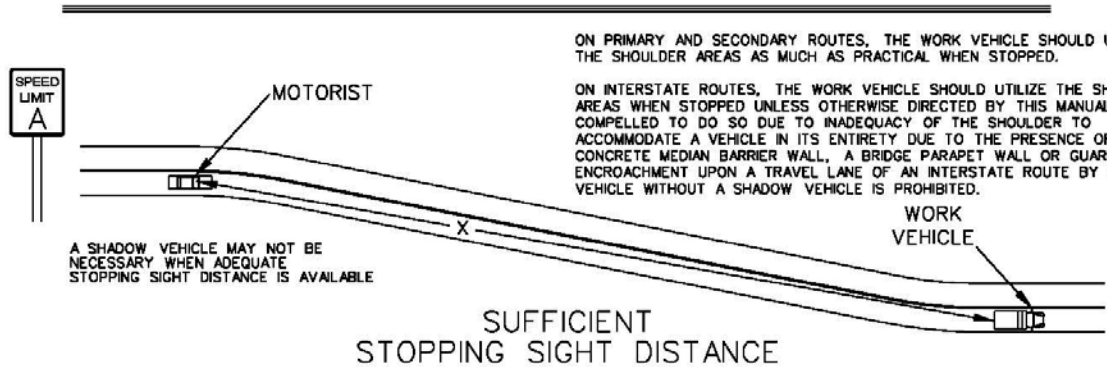

**MOBILE OPERATIONS
INTERMITTENT
LOW VOLUME
LOW SPEED / INTERMEDIATE SPEED TO HIGH SPEED
PRIMARY & SECONDARY ROUTES**

1. Intermittent mobile operations are mobile operations that move at speeds less than 3 mph or involve frequent short stops.

2. Roadway characteristics such as type, speed classification and volume classification shall determine the traffic control requirements for intermittent mobile operations. **A shadow vehicle shall accompany the work vehicle when the stopping sight distance interval between the work vehicle and an approaching motorist is unavailable based upon the posted regulatory speed limit of the specific location and/or the work is conducted during the hours of darkness.** A shadow vehicle may not be necessary during daytime hours when adequate sight distance is available. **A shadow vehicle is REQUIRED during ALL intermittent mobile operations conducted during the hours of darkness.**

Primary and Secondary Routes

- A. The work vehicle and the shadow vehicle shall utilize the shoulder areas as much as practical when stopped.
- B. The maximum time duration of a stop is 15 minutes if the work vehicle and/or the shadow vehicle must encroach upon a travel lane more than 2 feet.
- C. The maximum time duration of a stop is 30 minutes if the work vehicle and the shadow vehicle remain in the shoulder area in their entirety or encroaches upon a travel lane no more than 2 feet.

3. On low volume low speed roadways, intermittent mobile operations may be conducted with one person in the work vehicle. However, a minimum number of 2 persons in the work vehicle is recommended so that one person may act as a spotter while the other person performs the work. **Shadow vehicles may be optional for work operations on low volume low speed roadways provided the work vehicles and/or equipment is equipped with AMBER or YELLOW colored high intensity rotating, flashing, oscillating or strobe auxiliary warning lights.**

4. On low volume intermediate speed to high speed roadways, intermittent mobile operations may be conducted with one person in the work vehicle. However, a minimum number of 2 persons in the work vehicle is recommended so that one person may act as a spotter while the other person performs the work. **Evaluate the potential sight distance restrictions and posted regulatory speed limits of these roadways prior to deployment of the work detail to determine the minimum vehicle train requirements.**

5. Maintain two-way radio communication between all vehicles when more than 1 vehicle is utilized.

6. Supplement all vehicles operating in the vehicle train with amber colored auxiliary warning lights. The auxiliary warning lights shall be high intensity rotating, flashing, oscillating or strobe lights. Standard vehicle hazard warning lights are only permitted as a supplement to the auxiliary warning lights.

7. When a Single Work Vehicle is utilized on **TWO-LANE TWO-WAY ROADWAYS**, the Single Work Vehicle may be supplemented with a truck mounted advance warning arrow panel operating in the "Four Corner" Caution Mode with one lamp in each corner.

When a Vehicle Train is utilized on **TWO-LANE TWO-WAY ROADWAYS**, either or both the Work Vehicle and the Shadow Vehicle, may be supplemented with a truck mounted advance warning arrow panel operating in the "Four Corner" Caution Mode with one lamp in each corner.

DRAWING 535-02-A
MOBILE OPERATIONS
INTERMITTENT
LOW VOLUME
LOW SPEED
PRIMARY & SECONDARY ROUTES

STOPPING SIGHT DISTANCE REQUIREMENTS			
POSTED REGULATORY SPEED LIMIT (A)	PASSENGER CAR DISTANCE (X)	TRUCK DISTANCE (X)	SHADOW VEHICLE to WORK VEHICLE DISTANCE (Y)
≤ 35 MPH	250 FEET	350 FEET	50-250 FEET
40 MPH to 55 MPH	500 FEET	750 FEET	75-500 FEET
60 MPH to 70 MPH	750 FEET	1100 FEET	100-750 FEET

CONSIDER USING THE DISTANCES DESIGNATED AS "TRUCK" ON ROADWAYS WITH HIGH TRUCK VOLUMES

- (A) - POSTED REGULATORY SPEED LIMIT
- (X) - STOPPING SIGHT DISTANCE INTERVAL
- (Y) - RECOMMENDED MINIMUM DISTANCE INTERVAL BETWEEN SHADOW VEHICLE AND WORK VEHICLE OR PEDESTRIAN WORKERS WHEN PEDESTRIAN WORKERS ARE PRESENT

GENERAL NOTES:

1. STOPPING SIGHT DISTANCE IS THE LENGTH OF ROADWAY NECESSARY FOR A VEHICLE TO STOP BEFORE REACHING A STATIONARY OBJECT OR SPECIFIC LOCATION IN ITS PATH.
2. UTILIZE A SHADOW VEHICLE TO ACCOMPANY THE WORK VEHICLE WHEN THE STOPPING SIGHT DISTANCE BETWEEN THE WORK VEHICLE AND AN APPROACHING MOTORIST IS UNAVAILABLE BASED UPON THE POSTED REGULATORY SPEED LIMIT.
3. WHEN UTILIZING A SHADOW VEHICLE, LOCATE THE SHADOW VEHICLE TO PROVIDE SUFFICIENT STOPPING SIGHT DISTANCE BETWEEN AN APPROACHING MOTORIST AND THE SHADOW VEHICLE.
4. THE WORK VEHICLE AND THE SHADOW VEHICLE SHOULD UTILIZE AND REMAIN WITHIN THE SHOULDER AREA AS MUCH AS PRACTICAL.
5. A SHADOW VEHICLE IS REQUIRED DURING ALL INTERMITTENT MOBILE OPERATIONS CONDUCTED DURING THE HOURS OF DARKNESS.
6. THE MAXIMUM TIME DURATION OF A STOP IS 15 MINUTES IF THE WORK VEHICLE AND/OR THE SHADOW VEHICLE MUST ENCROACH UPON A TRAVEL LANE MORE THAN 2 FEET.
7. THE MAXIMUM TIME DURATION OF A STOP IS 30 MINUTES IF THE WORK VEHICLE AND/OR THE SHADOW VEHICLE REMAIN IN THE SHOULDER AREA IN THEIR ENTIRETY OR ENCROACHES UPON A TRAVEL LANE NO MORE THAN 2 FEET.
8. A SHADOW VEHICLE MAY NOT BE NECESSARY DURING DAYTIME OPERATIONS WHEN ADEQUATE SIGHT DISTANCE IS AVAILABLE.

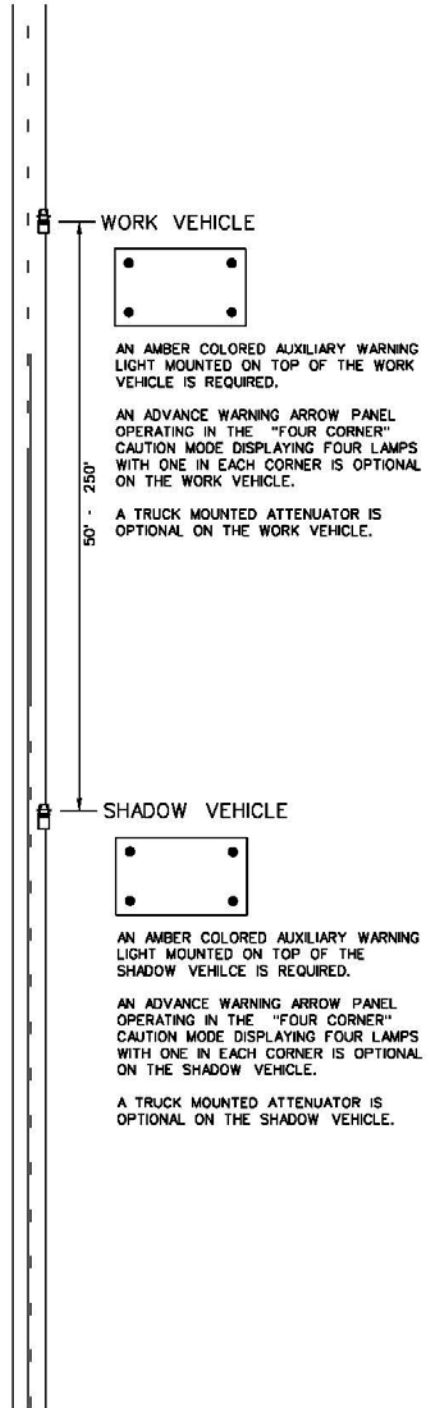

DRAWING 535-02-B
MOBILE OPERATIONS
INTERMITTENT
LOW VOLUME

INTERMEDIATE SPEED TO HIGH SPEED
PRIMARY & SECONDARY ROUTES

STOPPING SIGHT DISTANCE REQUIREMENTS			
POSTED REGULATORY SPEED LIMIT (A)	PASSENGER CAR DISTANCE (X)	TRUCK DISTANCE (X)	SHADOW VEHICLE to WORK VEHICLE DISTANCE (Y)
≤ 35 MPH	250 FEET	350 FEET	50-250 FEET
40 MPH to 55 MPH	500 FEET	750 FEET	75-500 FEET
60 MPH to 70 MPH	750 FEET	1100 FEET	100-750 FEET

CONSIDER USING THE DISTANCES DESIGNATED AS "TRUCK" ON ROADWAYS WITH HIGH TRUCK VOLUMES

(A) - POSTED REGULATORY SPEED LIMIT

(X) - STOPPING SIGHT DISTANCE INTERVAL

(Y) - RECOMMENDED MINIMUM DISTANCE INTERVAL BETWEEN SHADOW VEHICLE AND WORK VEHICLE OR PEDESTRIAN WORKERS WHEN PEDESTRIAN WORKERS ARE PRESENT

GENERAL NOTES:

1. STOPPING SIGHT DISTANCE IS THE LENGTH OF ROADWAY NECESSARY FOR A VEHICLE TO STOP BEFORE REACHING A STATIONARY OBJECT OR SPECIFIC LOCATION IN ITS PATH.
2. UTILIZE A SHADOW VEHICLE TO ACCOMPANY THE WORK VEHICLE WHEN THE STOPPING SIGHT DISTANCE BETWEEN THE WORK VEHICLE AND AN APPROACHING MOTORIST IS UNAVAILABLE BASED UPON THE POSTED REGULATORY SPEED LIMIT.
3. WHEN UTILIZING A SHADOW VEHICLE, LOCATE THE SHADOW VEHICLE TO PROVIDE SUFFICIENT STOPPING SIGHT DISTANCE BETWEEN AN APPROACHING MOTORIST AND THE SHADOW VEHICLE.
4. THE WORK VEHICLE AND THE SHADOW VEHICLE SHOULD UTILIZE AND REMAIN WITHIN THE SHOULDER AREA AS MUCH AS PRACTICAL.
5. A SHADOW VEHICLE IS REQUIRED DURING ALL INTERMITTENT MOBILE OPERATIONS CONDUCTED DURING THE HOURS OF DARKNESS.
6. THE MAXIMUM TIME DURATION OF A STOP IS 15 MINUTES IF THE WORK VEHICLE AND/OR THE SHADOW VEHICLE MUST ENCR OACH UPON A TRAVEL LANE MORE THAN 2 FEET.
7. THE MAXIMUM TIME DURATION OF A STOP IS 30 MINUTES IF THE WORK VEHICLE AND/OR THE SHADOW VEHICLE REMAIN IN THE SHOULDER AREA IN THEIR ENTIRETY OR ENCR OACHES UPON A TRAVEL LANE NO MORE THAN 2 FEET.
8. A SHADOW VEHICLE MAY NOT BE NECESSARY DURING DAYTIME OPERATIONS WHEN ADEQUATE SIGHT DISTANCE IS AVAILABLE.

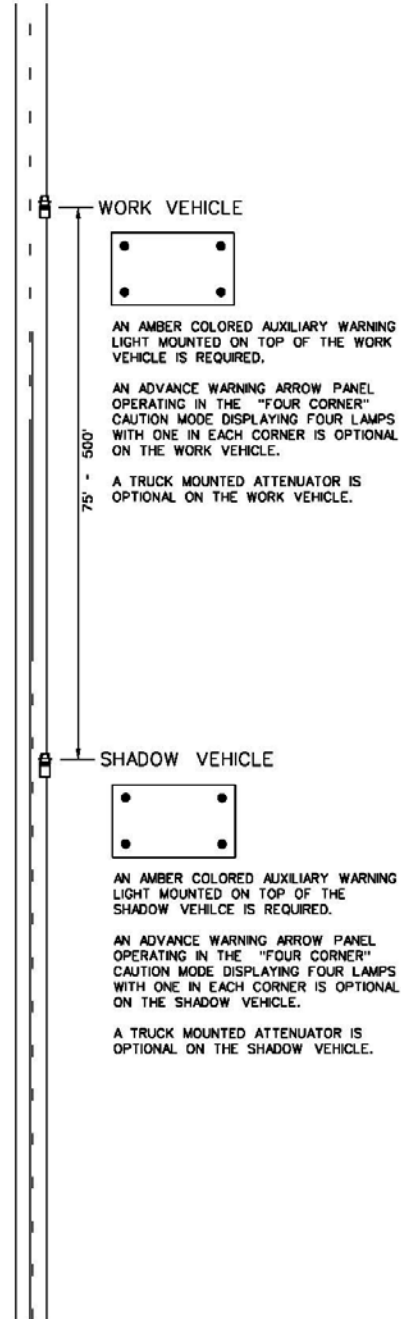

**MOBILE OPERATIONS
INTERMITTENT
INTERMEDIATE VOLUME
LOW SPEED / INTERMEDIATE SPEED TO HIGH SPEED
PRIMARY & SECONDARY ROUTES**

1. Intermittent mobile operations are mobile operations that move at speeds less than 3 mph or involve frequent short stops.
2. Roadway characteristics such as type, speed classification and volume classification shall determine the traffic control requirements for intermittent mobile operations. **A shadow vehicle shall accompany the work vehicle when the stopping sight distance interval between the work vehicle and an approaching motorist is unavailable based upon the posted regulatory speed limit of the specific location.** A shadow vehicle may not be necessary during daytime hours when adequate sight distance is available. **A shadow vehicle is REQUIRED during ALL intermittent mobile operations conducted during the hours of darkness.**

Primary and Secondary Routes

- A. The work vehicle and the shadow vehicle shall utilize the shoulder areas as much as practical when stopped.
 - B. The maximum time duration of a stop is 15 minutes if the work vehicle and/or the shadow vehicle must encroach upon a travel lane more than 2 feet.
 - C. The maximum time duration of a stop is 30 minutes if the work vehicle and the shadow vehicle remain in the shoulder area in their entirety or encroaches upon a travel lane no more than 2 feet.
3. On intermediate volume low speed to high speed roadways, intermittent mobile operations should be conducted with no less than 2 persons in the work vehicle. One person shall act as a spotter while the other person performs the work. **Evaluate the potential sight distance restrictions and posted regulatory speed limits of these roadways prior to deployment of the work detail to determine the minimum vehicle train requirements.**
 4. Maintain two-way radio communication between all vehicles when more than 1 vehicle is utilized.
 5. Supplement all vehicles operating in the vehicle train with amber colored auxiliary warning lights. The auxiliary warning lights shall be high intensity rotating, flashing, oscillating or strobe lights. Standard vehicle hazard warning lights are only permitted as a supplement to the auxiliary warning lights.
 6. When a Single Work Vehicle is utilized on **TWO-LANE TWO-WAY ROADWAYS**, the Single Work Vehicle may be supplemented with a truck mounted advance warning arrow panel operating in the "Four Corner" Caution Mode with one lamp in each corner.
When a Vehicle Train is utilized on **TWO-LANE TWO-WAY ROADWAYS**, either or both the Work Vehicle and the Shadow Vehicle, may be supplemented with a truck mounted advance warning arrow panel operating in the "Four Corner" Caution Mode with one lamp in each corner.
 7. When a Single Work Vehicle is utilized on **MULTILANE ROADWAYS**, the Single Work Vehicle may be supplemented with a truck mounted advance warning arrow panel operating in in a Flashing Arrow Mode or a Sequential Chevron Mode.
When a Vehicle Train including a Work Vehicle and a Shadow Vehicle is utilized on **MULTILANE ROADWAYS**, supplement no less than **ONE** of the vehicles in the Vehicle Train with a truck mounted advance warning arrow panel operating in a Flashing Arrow Mode or a Sequential Chevron Mode. A truck mounted advance warning arrow panel is recommended but not required on the Work Vehicle. However, if the Work Vehicle is NOT supplemented with a truck mounted advance warning arrow panel, then a truck mounted advance warning arrow panel operating in a Flashing Arrow Mode or a Sequential Chevron Mode is REQUIRED on the Shadow Vehicle.

STOPPING SIGHT DISTANCE REQUIREMENTS

POSTED REGULATORY SPEED LIMIT (A)	PASSENGER CAR DISTANCE (X)	TRUCK DISTANCE (X)	SHADOW VEHICLE to WORK VEHICLE DISTANCE (Y)
≤ 35 MPH	250 FEET	350 FEET	50-250 FEET
40 MPH to 55 MPH	500 FEET	750 FEET	75-500 FEET
60 MPH to 70 MPH	750 FEET	1100 FEET	100-750 FEET

CONSIDER USING THE DISTANCES DESIGNATED AS "TRUCK" ON ROADWAYS WITH HIGH TRUCK VOLUMES

(A) - POSTED REGULATORY SPEED LIMIT

(X) - STOPPING SIGHT DISTANCE INTERVAL

(Y) - RECOMMENDED MINIMUM DISTANCE INTERVAL BETWEEN SHADOW VEHICLE AND WORK VEHICLE OR PEDESTRIAN WORKERS WHEN PEDESTRIAN WORKERS ARE PRESENT

DRAWING 535-03-A MOBILE OPERATIONS INTERMITTENT INTERMEDIATE VOLUME LOW SPEED PRIMARY & SECONDARY ROUTES

GENERAL NOTES:

1. STOPPING SIGHT DISTANCE IS THE LENGTH OF ROADWAY NECESSARY FOR A VEHICLE TO STOP BEFORE REACHING A STATIONARY OBJECT OR SPECIFIC LOCATION IN ITS PATH.
2. UTILIZE A SHADOW VEHICLE TO ACCOMPANY THE WORK VEHICLE WHEN THE STOPPING SIGHT DISTANCE BETWEEN THE WORK VEHICLE AND AN APPROACHING MOTORIST IS UNAVAILABLE BASED UPON THE POSTED REGULATORY SPEED LIMIT.
3. WHEN UTILIZING A SHADOW VEHICLE, LOCATE THE SHADOW VEHICLE TO PROVIDE SUFFICIENT STOPPING SIGHT DISTANCE BETWEEN AN APPROACHING MOTORIST AND THE SHADOW VEHICLE.
4. THE WORK VEHICLE AND THE SHADOW VEHICLE SHOULD UTILIZE AND REMAIN WITHIN THE SHOULDER AREA AS MUCH AS PRACTICAL.
5. A SHADOW VEHICLE IS REQUIRED DURING ALL INTERMITTENT MOBILE OPERATIONS CONDUCTED DURING THE HOURS OF DARKNESS.
6. THE MAXIMUM TIME DURATION OF A STOP IS 15 MINUTES IF THE WORK VEHICLE AND/OR THE SHADOW VEHICLE MUST ENCR OACH UPON A TRAVEL LANE MORE THAN 2 FEET.
7. THE MAXIMUM TIME DURATION OF A STOP IS 30 MINUTES IF THE WORK VEHICLE AND/OR THE SHADOW VEHICLE REMAIN IN THE SHOULDER AREA IN THEIR ENTIRETY OR ENCR OACHES UPON A TRAVEL LANE NO MORE THAN 2 FEET.
8. A SHADOW VEHICLE MAY NOT BE NECESSARY DURING DAYTIME OPERATIONS WHEN ADEQUATE SIGHT DISTANCE IS AVAILABLE.

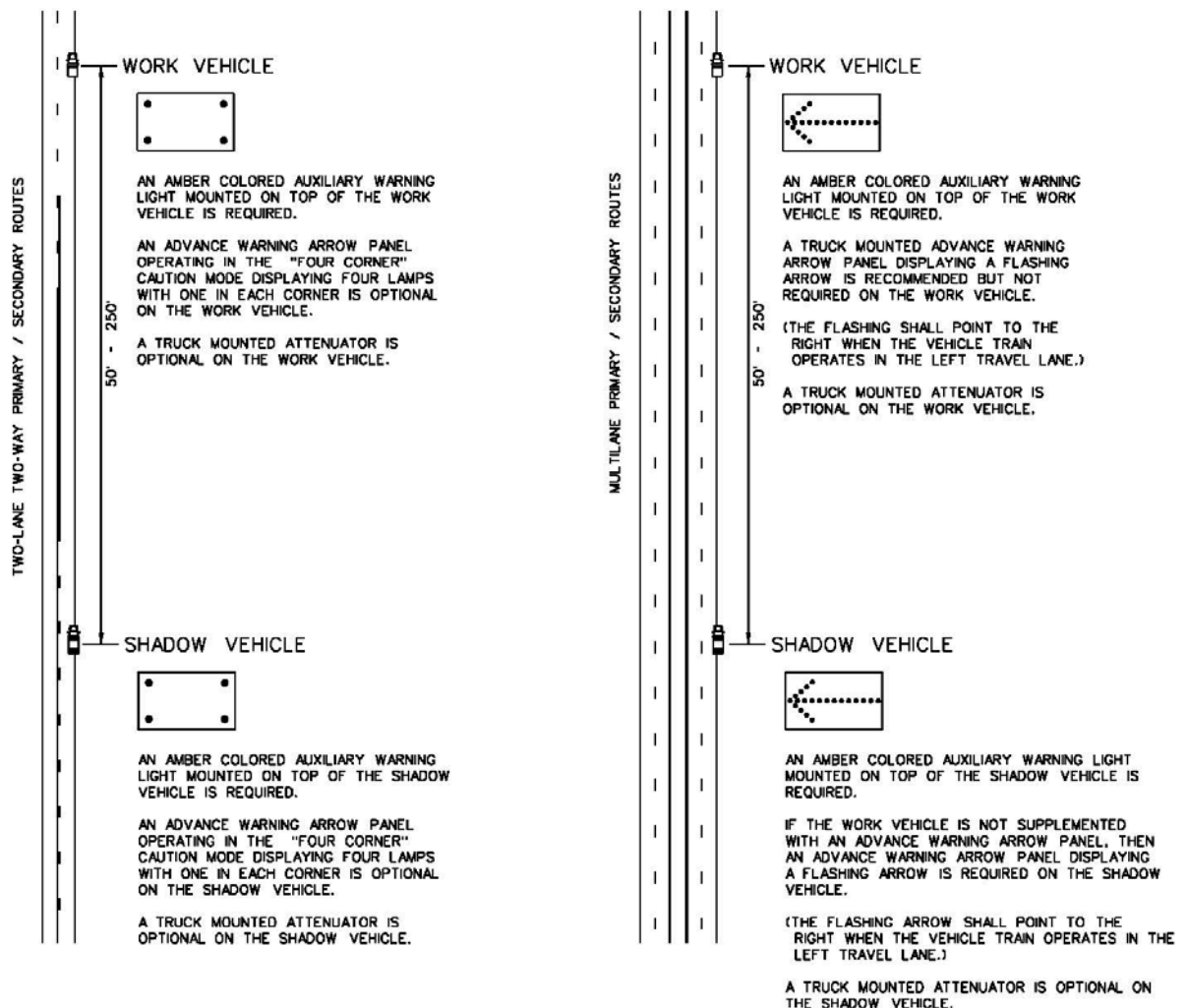

STOPPING SIGHT DISTANCE REQUIREMENTS

POSTED REGULATORY SPEED LIMIT (A)	PASSENGER CAR DISTANCE (X)	TRUCK DISTANCE (X)	SHADOW VEHICLE to WORK VEHICLE DISTANCE (Y)
≤ 35 MPH	250 FEET	350 FEET	50-250 FEET
40 MPH to 55 MPH	500 FEET	750 FEET	75-500 FEET
60 MPH to 70 MPH	750 FEET	1100 FEET	100-750 FEET

CONSIDER USING THE DISTANCES DESIGNATED AS "TRUCK" ON ROADWAYS WITH HIGH TRUCK VOLUMES

(A) - POSTED REGULATORY SPEED LIMIT

(X) - STOPPING SIGHT DISTANCE INTERVAL

(Y) - RECOMMENDED MINIMUM DISTANCE INTERVAL BETWEEN SHADOW VEHICLE AND WORK VEHICLE OR PEDESTRIAN WORKERS WHEN PEDESTRIAN WORKERS ARE PRESENT

DRAWING 535-03-B MOBILE OPERATIONS INTERMITTENT INTERMEDIATE VOLUME INTERMEDIATE SPEED TO HIGH SPEED PRIMARY & SECONDARY ROUTES

GENERAL NOTES:

1. STOPPING SIGHT DISTANCE IS THE LENGTH OF ROADWAY NECESSARY FOR A VEHICLE TO STOP BEFORE REACHING A STATIONARY OBJECT OR SPECIFIC LOCATION IN ITS PATH.
2. UTILIZE A SHADOW VEHICLE TO ACCOMPANY THE WORK VEHICLE WHEN THE STOPPING SIGHT DISTANCE BETWEEN THE WORK VEHICLE AND AN APPROACHING MOTORIST IS UNAVAILABLE BASED UPON THE POSTED REGULATORY SPEED LIMIT.
3. WHEN UTILIZING A SHADOW VEHICLE, LOCATE THE SHADOW VEHICLE TO PROVIDE SUFFICIENT STOPPING SIGHT DISTANCE BETWEEN AN APPROACHING MOTORIST AND THE SHADOW VEHICLE.
4. THE WORK VEHICLE AND THE SHADOW VEHICLE SHOULD UTILIZE AND REMAIN WITHIN THE SHOULDER AREA AS MUCH AS PRACTICAL.
5. A SHADOW VEHICLE IS REQUIRED DURING ALL INTERMITTENT MOBILE OPERATIONS CONDUCTED DURING THE HOURS OF DARKNESS.
6. THE MAXIMUM TIME DURATION OF A STOP IS 15 MINUTES IF THE WORK VEHICLE AND/OR THE SHADOW VEHICLE MUST ENCRoACH UPON A TRAVEL LANE MORE THAN 2 FEET.
7. THE MAXIMUM TIME DURATION OF A STOP IS 30 MINUTES IF THE WORK VEHICLE AND/OR THE SHADOW VEHICLE REMAIN IN THE SHOULDER AREA IN THEIR ENTIRETY OR ENCRoACHES UPON A TRAVEL LANE NO MORE THAN 2 FEET.
8. A SHADOW VEHICLE MAY NOT BE NECESSARY DURING DAYTIME OPERATIONS WHEN ADEQUATE SIGHT DISTANCE IS AVAILABLE.

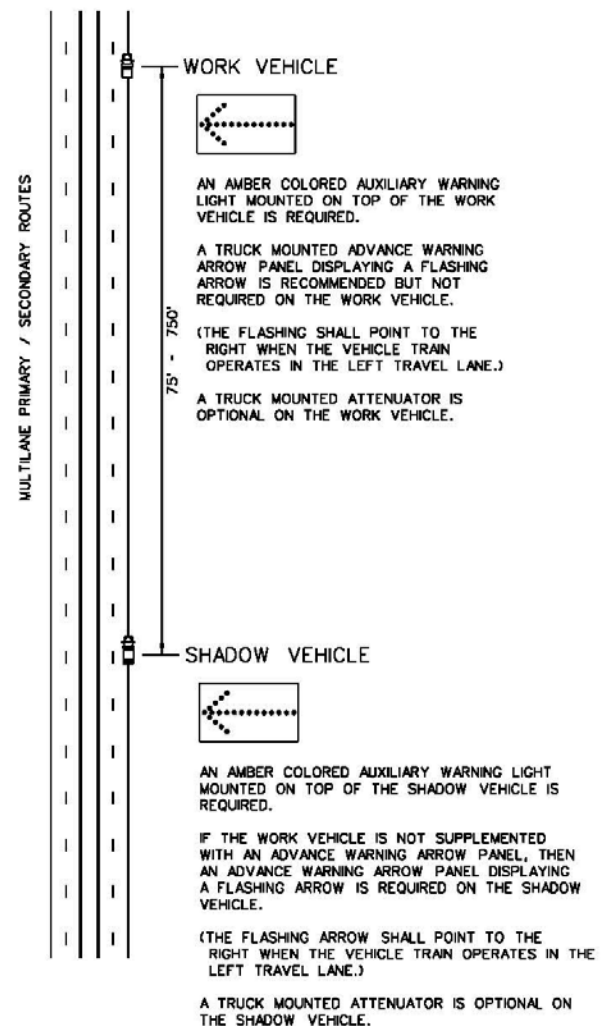
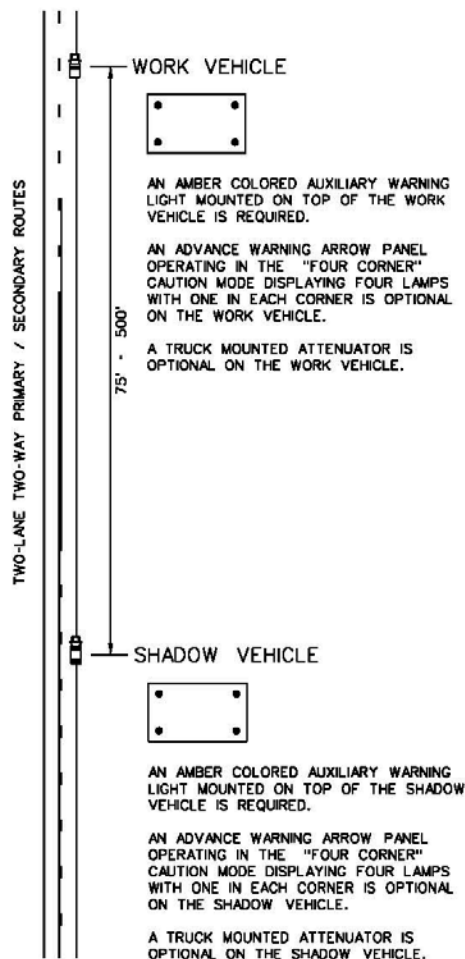

**MOBILE OPERATIONS
INTERMITTENT
HIGH VOLUME
LOW SPEED
PRIMARY & SECONDARY ROUTES**

1. Intermittent mobile operations are mobile operations that move at speeds less than 3 mph or involve frequent short stops.
2. Roadway characteristics such as type, speed classification and volume classification shall determine the traffic control requirements for intermittent mobile operations. **A shadow vehicle shall accompany the work vehicle when the stopping sight distance interval between the work vehicle and an approaching motorist is unavailable based upon the posted regulatory speed limit of the specific location.** A shadow vehicle may not be necessary during daytime hours when adequate sight distance is available. **A shadow vehicle is REQUIRED during ALL intermittent mobile operations conducted during the hours of darkness.**

Primary and Secondary Routes

- A. The work vehicle and the shadow vehicle shall utilize the shoulder areas as much as practical when stopped.
 - B. The maximum time duration of a stop is 15 minutes if the work vehicle and/or the shadow vehicle must encroach upon a travel lane more than 2 feet.
 - C. The maximum time duration of a stop is 30 minutes if the work vehicle and the shadow vehicle remain in the shoulder area in their entirety or encroaches upon a travel lane no more than 2 feet.
3. On high volume low speed roadways, conduct intermittent mobile operations with no less than 2 persons in the work vehicle. One person shall act as a spotter while the other person performs the work. **Evaluate the potential sight distance restrictions and posted regulatory speed limits of these roadways prior to deployment of the work detail to determine the minimum vehicle train requirements.**
 4. Maintain two-way radio communication between all vehicles when more than 1 vehicle is utilized.
 5. Supplement all vehicles operating in the vehicle train with amber colored auxiliary warning lights. The auxiliary warning lights shall be high intensity rotating, flashing, oscillating or strobe lights. Standard vehicle hazard warning lights are only permitted as a supplement to the auxiliary warning lights.
 6. When a Single Work Vehicle is utilized on **TWO-LANE TWO-WAY ROADWAYS**, the Single Work Vehicle may be supplemented with a truck mounted advance warning arrow panel operating in the "Four Corner" Caution Mode with one lamp in each corner.
When a Vehicle Train is utilized on **TWO-LANE TWO-WAY ROADWAYS**, either or both the Work Vehicle and the Shadow Vehicle, may be supplemented with a truck mounted advance warning arrow panel operating in the "Four Corner" Caution Mode with one lamp in each corner.
 7. When a Single Work Vehicle is utilized on **MULTILANE ROADWAYS**, the Single Work Vehicle may be supplemented with a truck mounted advance warning arrow panel operating in in a Flashing Arrow Mode or a Sequential Chevron Mode.
When a Vehicle Train including a Work Vehicle and a Shadow Vehicle is utilized on **MULTILANE ROADWAYS**, supplement no less than **ONE** of the vehicles in the Vehicle Train with a truck mounted advance warning arrow panel operating in a Flashing Arrow Mode or a Sequential Chevron Mode. A truck mounted advance warning arrow panel is recommended but not required on the Work Vehicle. However, if the Work Vehicle is NOT supplemented with a truck mounted advance warning arrow panel, then a truck mounted advance warning arrow panel operating in a Flashing Arrow Mode or a Sequential Chevron Mode is REQUIRED on the Shadow Vehicle.

STOPPING SIGHT DISTANCE REQUIREMENTS

POSTED REGULATORY SPEED LIMIT (A)	PASSENGER CAR DISTANCE (X)	TRUCK DISTANCE (X)	SHADOW VEHICLE to WORK VEHICLE DISTANCE (Y)
≤ 35 MPH	250 FEET	350 FEET	50-250 FEET
40 MPH to 55 MPH	500 FEET	750 FEET	75-500 FEET
60 MPH to 70 MPH	750 FEET	1100 FEET	100-750 FEET

CONSIDER USING THE DISTANCES DESIGNATED AS "TRUCK" ON ROADWAYS WITH HIGH TRUCK VOLUMES

(A) - POSTED REGULATORY SPEED LIMIT

(X) - STOPPING SIGHT DISTANCE INTERVAL

(Y) - RECOMMENDED MINIMUM DISTANCE INTERVAL BETWEEN SHADOW VEHICLE AND WORK VEHICLE OR PEDESTRIAN WORKERS WHEN PEDESTRIAN WORKERS ARE PRESENT

DRAWING 535-04-A MOBILE OPERATIONS INTERMITTENT HIGH VOLUME LOW SPEED PRIMARY & SECONDARY ROUTES

GENERAL NOTES:

1. STOPPING SIGHT DISTANCE IS THE LENGTH OF ROADWAY NECESSARY FOR A VEHICLE TO STOP BEFORE REACHING A STATIONARY OBJECT OR SPECIFIC LOCATION IN ITS PATH.
2. UTILIZE A SHADOW VEHICLE TO ACCOMPANY THE WORK VEHICLE WHEN THE STOPPING SIGHT DISTANCE BETWEEN THE WORK VEHICLE AND AN APPROACHING MOTORIST IS UNAVAILABLE BASED UPON THE POSTED REGULATORY SPEED LIMIT.
3. WHEN UTILIZING A SHADOW VEHICLE, LOCATE THE SHADOW VEHICLE TO PROVIDE SUFFICIENT STOPPING SIGHT DISTANCE BETWEEN AN APPROACHING MOTORIST AND THE SHADOW VEHICLE.
4. THE WORK VEHICLE AND THE SHADOW VEHICLE SHOULD UTILIZE AND REMAIN WITHIN THE SHOULDER AREA AS MUCH AS PRACTICAL.
5. A SHADOW VEHICLE IS REQUIRED DURING ALL INTERMITTENT MOBILE OPERATIONS CONDUCTED DURING THE HOURS OF DARKNESS.
6. THE MAXIMUM TIME DURATION OF A STOP IS 15 MINUTES IF THE WORK VEHICLE AND/OR THE SHADOW VEHICLE MUST ENCR OACH UPON A TRAVEL LANE MORE THAN 2 FEET.
7. THE MAXIMUM TIME DURATION OF A STOP IS 30 MINUTES IF THE WORK VEHICLE AND/OR THE SHADOW VEHICLE REMAIN IN THE SHOULDER AREA IN THEIR ENTIRETY OR ENCR OACHES UPON A TRAVEL LANE NO MORE THAN 2 FEET.
8. A SHADOW VEHICLE MAY NOT BE NECESSARY DURING DAYTIME OPERATIONS WHEN ADEQUATE SIGHT DISTANCE IS AVAILABLE.

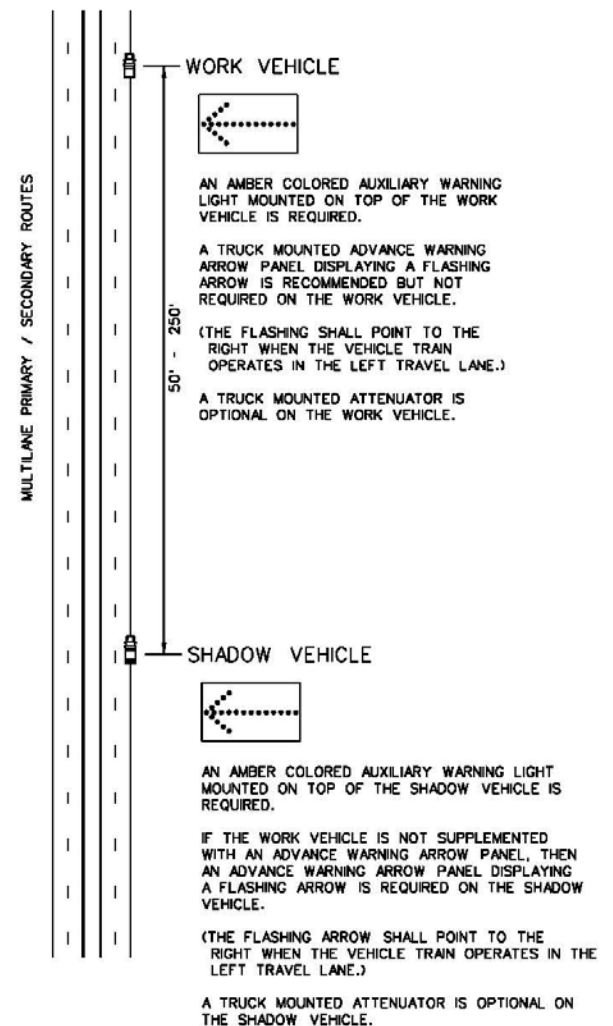
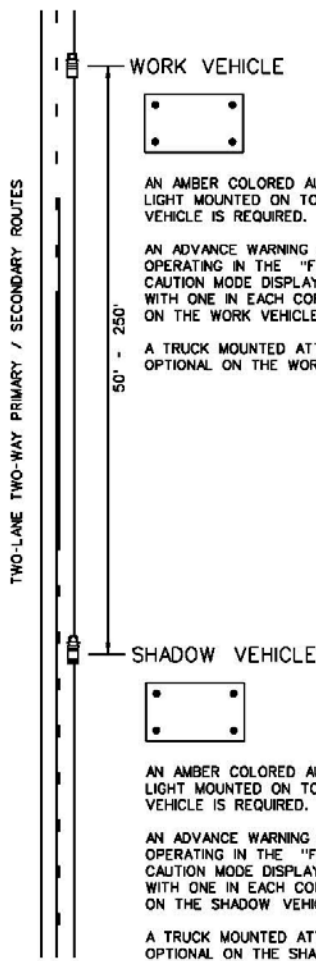

**MOBILE OPERATIONS
INTERMITTENT
HIGH VOLUME
LOW SPEED
INTERIOR TRAVEL LANE OPERATIONS
PRIMARY & SECONDARY ROUTES**

1. Intermittent mobile operations are mobile operations that move at speeds less than 3 mph or involve frequent short stops.
2. Roadway characteristics such as type, speed classification and volume classification shall determine the traffic control requirements for intermittent mobile operations. **A shadow vehicle is REQUIRED and SHALL accompany the work vehicle during ALL intermittent mobile operations conducted within an interior travel lane.** The shadow vehicle should operate at close range behind the work vehicle while maintaining adequate stopping sight distance to minimize encroachment by motorists between the work vehicle and the shadow vehicle when operating in an interior travel lane.

Primary and Secondary Routes

- A. The maximum time duration of a stop is 15 minutes when the work vehicle and the shadow vehicle are operating within an interior travel lane.
 - B. A shadow vehicle is **REQUIRED** for all work operations within an interior travel lane. Operating a work vehicle in an interior travel lane without a shadow vehicle is **PROHIBITED**.
3. On high volume low speed roadways, conduct intermittent mobile operations with no less than 2 persons in the work vehicle. One person shall act as a spotter while the other person performs the work. **Evaluate the potential sight distance restrictions and posted regulatory speed limits of these roadways prior to deployment of the work detail to determine the minimum vehicle train requirements.**
 4. Maintain two-way radio communication between all vehicles when more than 1 vehicle is utilized.
 5. Supplement all vehicles operating in the vehicle train with amber colored auxiliary warning lights. The auxiliary warning lights shall be high intensity rotating, flashing, oscillating or strobe lights. Standard vehicle hazard warning lights are only permitted as a supplement to the auxiliary warning lights.
 6. When a Vehicle Train including a Work Vehicle and a Shadow Vehicle is utilized on **MULTILANE ROADWAYS** in an interior travel lane as illustrated in this traffic control setup, supplementation of both the Single Work Vehicle and the Shadow Vehicle with a truck mounted advance warning arrow panel operating in a Flashing Arrow Mode or a Sequential Chevron Mode is **REQUIRED**.

STOPPING SIGHT DISTANCE REQUIREMENTS

POSTED REGULATORY SPEED LIMIT (A)	PASSENGER CAR DISTANCE (X)	TRUCK DISTANCE (X)	SHADOW VEHICLE to WORK VEHICLE DISTANCE (Y)
≤ 35 MPH	250 FEET	350 FEET	50-250 FEET
40 MPH to 55 MPH	500 FEET	750 FEET	75-500 FEET
60 MPH to 70 MPH	750 FEET	1100 FEET	100-750 FEET

CONSIDER USING THE DISTANCES DESIGNATED AS "TRUCK" ON ROADWAYS WITH HIGH TRUCK VOLUMES

(A) - POSTED REGULATORY SPEED LIMIT

(X) - STOPPING SIGHT DISTANCE INTERVAL

(Y) - RECOMMENDED MINIMUM DISTANCE INTERVAL BETWEEN SHADOW VEHICLE AND WORK VEHICLE OR PEDESTRIAN WORKERS WHEN PEDESTRIAN WORKERS ARE PRESENT

DRAWING 535-04-B MOBILE OPERATIONS INTERMITTENT HIGH VOLUME LOW SPEED INTERIOR TRAVEL LANE OPERATIONS PRIMARY & SECONDARY ROUTES

GENERAL NOTES:

1. STOPPING SIGHT DISTANCE IS THE LENGTH OF ROADWAY NECESSARY FOR A VEHICLE TO STOP BEFORE REACHING A STATIONARY OBJECT OR SPECIFIC LOCATION IN ITS PATH.
2. A SHADOW VEHICLE IS REQUIRED DURING ALL INTERMITTENT MOBILE OPERATIONS CONDUCTED WITHIN AN INTERIOR TRAVEL LANE.
3. WHEN UTILIZING A SHADOW VEHICLE, LOCATE THE SHADOW VEHICLE TO PROVIDE SUFFICIENT STOPPING SIGHT DISTANCE BETWEEN AN APPROACHING MOTORIST AND THE SHADOW VEHICLE.
4. WHEN THE VEHICLE TRAIN OPERATES WITHIN AN INTERIOR TRAVEL LANE ADJACENT TO A SHOULDER, (i.e. LEFT TRAVEL LANE / LEFT SHOULDER), THE WORK VEHICLE AND THE SHADOW VEHICLE SHOULD UTILIZE AND REMAIN WITHIN THE SHOULDER AREAS AS MUCH AS PRACTICAL.
5. THE MAXIMUM TIME DURATION OF A STOP IS 15 MINUTES WHEN THE VEHICLE TRAIN OPERATES WITHIN AN INTERIOR TRAVEL LANE.
6. A SHADOW VEHICLE IS REQUIRED DURING ALL INTERMITTENT MOBILE OPERATIONS CONDUCTED DURING THE HOURS OF DARKNESS.

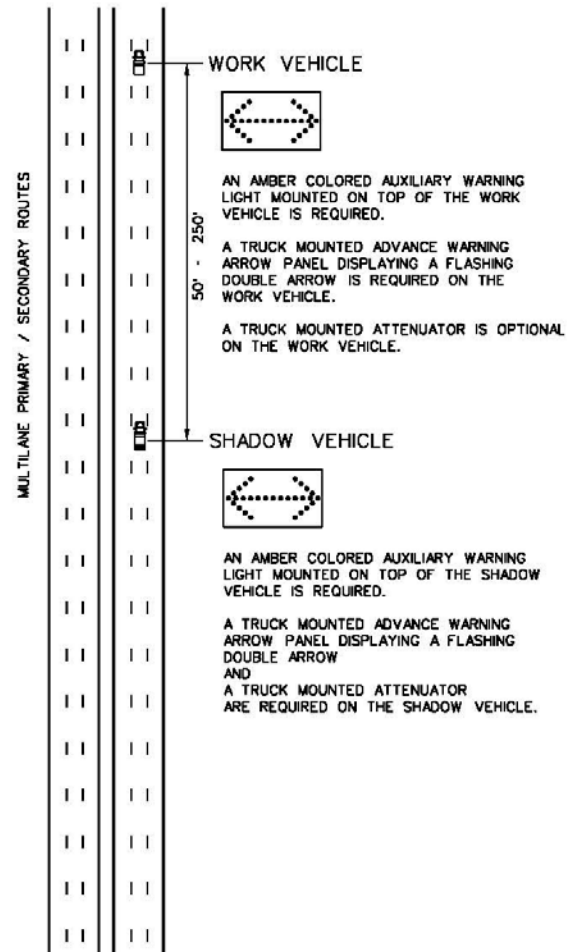
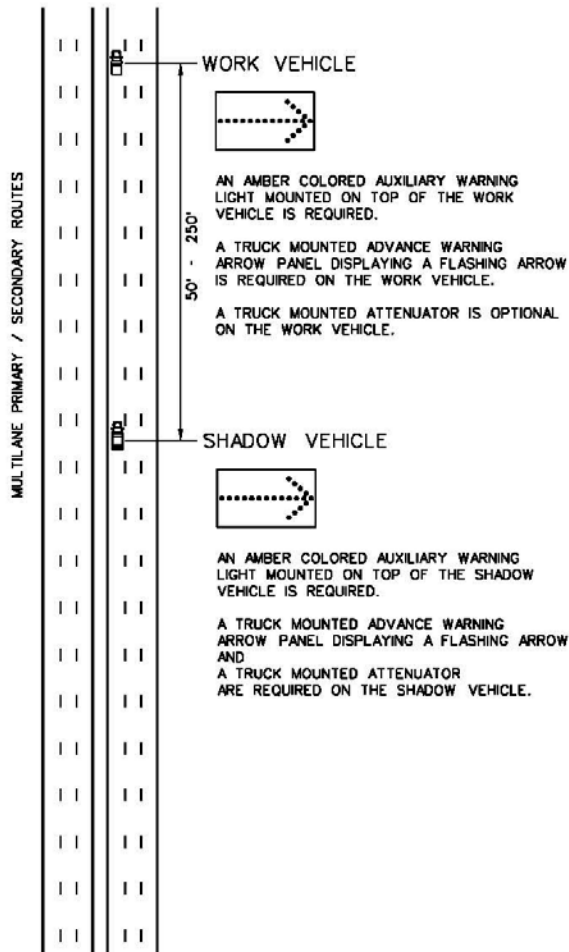

**MOBILE OPERATIONS
INTERMITTENT
HIGH VOLUME
INTERMEDIATE SPEED TO HIGH SPEED
PRIMARY & SECONDARY ROUTES**

1. Intermittent mobile operations are mobile operations that move at speeds less than 3 mph or involve frequent short stops.
2. Roadway characteristics such as type, speed classification and volume classification shall determine the traffic control requirements for intermittent mobile operations. **A shadow vehicle shall accompany the work vehicle when the stopping sight distance interval between the work vehicle and an approaching motorist is unavailable based upon the posted regulatory speed limit of the specific location.** A shadow vehicle may not be necessary during daytime hours when adequate sight distance is available. **A shadow vehicle is REQUIRED during ALL intermittent mobile operations conducted during the hours of darkness.**

Primary and Secondary Routes

- A. The work vehicle and the shadow vehicle shall utilize the shoulder areas as much as practical when stopped.
 - B. The maximum time duration of a stop is 15 minutes if the work vehicle and/or the shadow vehicle must encroach upon a travel lane more than 2 feet.
 - C. The maximum time duration of a stop is 30 minutes if the work vehicle and the shadow vehicle remain in the shoulder area in their entirety or encroaches upon a travel lane no more than 2 feet.
3. On high volume intermediate speed to high speed roadways, intermittent mobile operations should be conducted with no less than 2 persons in the work vehicle. One person shall act as a spotter while the other person performs the work. **Evaluate the potential sight distance restrictions and posted regulatory speed limits of these roadways prior to deployment of the work detail to determine the minimum vehicle train requirements.**
 4. Maintain two-way radio communication between all vehicles when more than 1 vehicle is utilized.
 5. Supplement all vehicles operating in the vehicle train with amber colored auxiliary warning lights. The auxiliary warning lights shall be high intensity rotating, flashing, oscillating or strobe lights. Standard vehicle hazard warning lights are only permitted as a supplement to the auxiliary warning lights.
 6. When a Single Work Vehicle is utilized on **TWO-LANE TWO-WAY ROADWAYS**, the Single Work Vehicle may be supplemented with a truck mounted advance warning arrow panel operating in the "Four Corner" Caution Mode with one lamp in each corner.
When a Vehicle Train is utilized on **TWO-LANE TWO-WAY ROADWAYS**, either or both the Work Vehicle and the Shadow Vehicle, may be supplemented with a truck mounted advance warning arrow panel operating in the "Four Corner" Caution Mode with one lamp in each corner.
 7. When a Single Work Vehicle is utilized on **MULTILANE ROADWAYS**, the Single Work Vehicle may be supplemented with a truck mounted advance warning arrow panel operating in in a Flashing Arrow Mode or a Sequential Chevron Mode.
When a Vehicle Train including a Work Vehicle and a Shadow Vehicle is utilized on **MULTILANE ROADWAYS**, supplement no less than **ONE** of the vehicles in the Vehicle Train with a truck mounted advance warning arrow panel operating in a Flashing Arrow Mode or a Sequential Chevron Mode. A truck mounted advance warning arrow panel is recommended but not required on the Work Vehicle. However, if the Work Vehicle is NOT supplemented with a truck mounted advance warning arrow panel, then a truck mounted advance warning arrow panel operating in a Flashing Arrow Mode or a Sequential Chevron Mode is REQUIRED on the Shadow Vehicle.

STOPPING SIGHT DISTANCE REQUIREMENTS

POSTED REGULATORY SPEED LIMIT (A)	PASSENGER CAR DISTANCE (X)	TRUCK DISTANCE (X)	SHADOW VEHICLE to WORK VEHICLE DISTANCE (Y)
≤ 35 MPH	250 FEET	350 FEET	50-250 FEET
40 MPH to 55 MPH	500 FEET	750 FEET	75-500 FEET
60 MPH to 70 MPH	750 FEET	1100 FEET	100-750 FEET

CONSIDER USING THE DISTANCES DESIGNATED AS "TRUCK" ON ROADWAYS WITH HIGH TRUCK VOLUMES

(A) - POSTED REGULATORY SPEED LIMIT

(X) - STOPPING SIGHT DISTANCE INTERVAL

(Y) - RECOMMENDED MINIMUM DISTANCE INTERVAL BETWEEN SHADOW VEHICLE AND WORK VEHICLE OR PEDESTRIAN WORKERS WHEN PEDESTRIAN WORKERS ARE PRESENT

DRAWING 535-04-C MOBILE OPERATIONS INTERMITTENT HIGH VOLUME INTERMEDIATE SPEED TO HIGH SPEED PRIMARY & SECONDARY ROUTES

GENERAL NOTES:

1. STOPPING SIGHT DISTANCE IS THE LENGTH OF ROADWAY NECESSARY FOR A VEHICLE TO STOP BEFORE REACHING A STATIONARY OBJECT OR SPECIFIC LOCATION IN ITS PATH.
2. UTILIZE A SHADOW VEHICLE TO ACCOMPANY THE WORK VEHICLE WHEN THE STOPPING SIGHT DISTANCE BETWEEN THE WORK VEHICLE AND AN APPROACHING MOTORIST IS UNAVAILABLE BASED UPON THE POSTED REGULATORY SPEED LIMIT.
3. WHEN UTILIZING A SHADOW VEHICLE, LOCATE THE SHADOW VEHICLE TO PROVIDE SUFFICIENT STOPPING SIGHT DISTANCE BETWEEN AN APPROACHING MOTORIST AND THE SHADOW VEHICLE.
4. THE WORK VEHICLE AND THE SHADOW VEHICLE SHOULD UTILIZE AND REMAIN WITHIN THE SHOULDER AREA AS MUCH AS PRACTICAL.
5. A SHADOW VEHICLE IS REQUIRED DURING ALL INTERMITTENT MOBILE OPERATIONS CONDUCTED DURING THE HOURS OF DARKNESS.
6. THE MAXIMUM TIME DURATION OF A STOP IS 15 MINUTES IF THE WORK VEHICLE AND/OR THE SHADOW VEHICLE MUST ENCR OACH UPON A TRAVEL LANE MORE THAN 2 FEET.
7. THE MAXIMUM TIME DURATION OF A STOP IS 30 MINUTES IF THE WORK VEHICLE AND/OR THE SHADOW VEHICLE REMAIN IN THE SHOULDER AREA IN THEIR ENTIRETY OR ENCR OACHES UPON A TRAVEL LANE NO MORE THAN 2 FEET.
8. A SHADOW VEHICLE MAY NOT BE NECESSARY DURING DAYTIME OPERATIONS WHEN ADEQUATE SIGHT DISTANCE IS AVAILABLE.

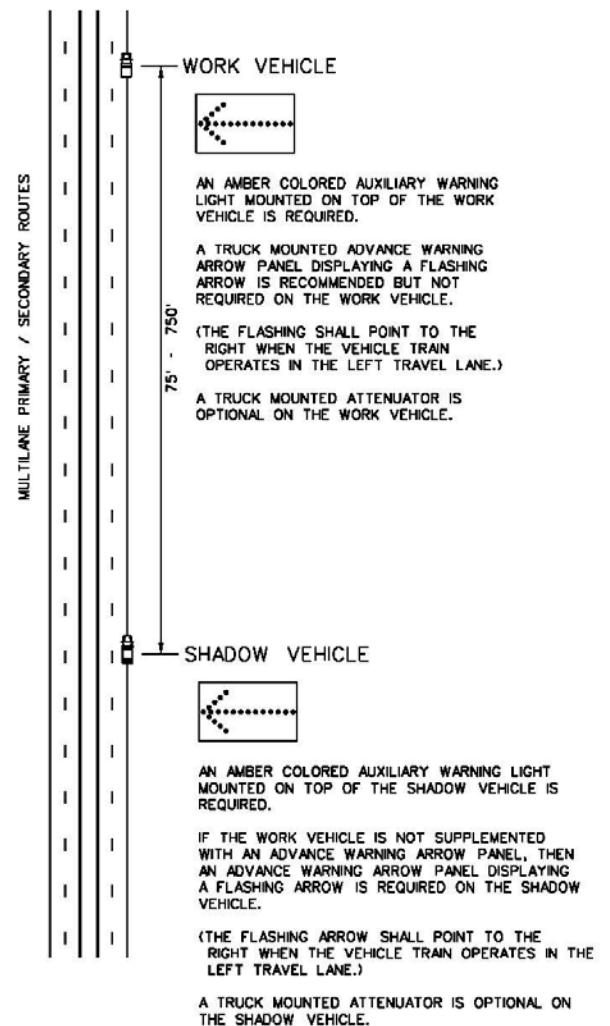
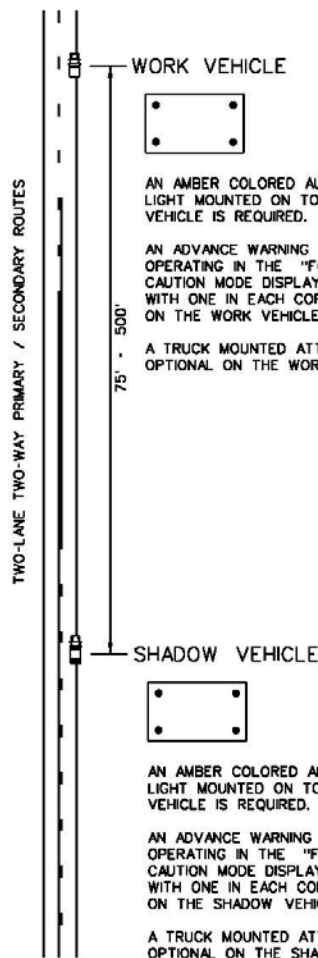

**MOBILE OPERATIONS
INTERMITTENT
HIGH VOLUME
HIGH SPEED
INTERSTATE ROUTES**

1. Intermittent mobile operations are mobile operations that move at speeds less than 3 mph or involve frequent short stops.
2. Roadway characteristics such as type, speed classification and volume classification shall determine the traffic control requirements for intermittent mobile operations. **A shadow vehicle shall accompany the work vehicle when the stopping sight distance interval between the work vehicle and an approaching motorist is unavailable based upon the posted regulatory speed limit of the specific location or the work vehicle must encroach upon a travel lane.** A shadow vehicle may not be necessary during daytime hours when adequate sight distance is available or encroachment of the work vehicle upon a travel lane is not required. **A shadow vehicle is REQUIRED during ALL intermittent mobile operations conducted during the hours of darkness.**

Interstate Routes

- A. Any encroachment upon an interstate travel lane by the work vehicle when stopped without the accompaniment of a shadow vehicle is PROHIBITED. A shadow vehicle may not be necessary when encroachment upon an adjacent travel lane by the work vehicle is unnecessary.
 - B. The maximum time duration of a stop is 5 minutes if the work vehicle and/or the shadow vehicle must encroach upon an adjacent travel lane due to a shoulder area inadequate to accommodate a vehicle in its entirety due to the presence of a concrete median wall, a bridge parapet wall or guardrail.
 - C. The maximum time duration of a stop is 30 minutes if the work vehicle and the shadow vehicle remain in the shoulder areas in their entirety with no encroachment upon an adjacent travel lane.
 - D. Encroachment upon a travel lane by the work vehicle and/or the shadow vehicle is only permitted in those areas with shoulder areas inadequate to accommodate a vehicle in its entirety due to the presence of a concrete median wall, a bridge parapet wall or guardrail unless otherwise directed by this manual.
3. On high volume high speed roadways, intermittent mobile operations should be conducted with no less than 2 persons in the work vehicle. One person shall act as a spotter while the other person performs the work. **Evaluate the potential sight distance restrictions and posted regulatory speed limits of these roadways prior to deployment of the work detail to determine the minimum vehicle train requirements.**
 4. Maintain two-way radio communication between all vehicles when more than 1 vehicle is utilized.
 5. Supplement all vehicles operating in the vehicle train with amber colored auxiliary warning lights. The auxiliary warning lights shall be high intensity rotating, flashing, oscillating or strobe lights. Standard vehicle hazard warning lights are only permitted as a supplement to the auxiliary warning lights.
 6. When a Single Work Vehicle is utilized on **INTERSTATE ROUTES**, the Single Work Vehicle may be supplemented with a truck mounted advance warning arrow panel operating in in a Flashing Arrow Mode or a Sequential Chevron Mode.
When a Vehicle Train including a Work Vehicle and a Shadow Vehicle is utilized on **INTERSTATE ROUTES**, supplement no less than **ONE** of the vehicles in the Vehicle Train with a truck mounted advance warning arrow panel operating in a Flashing Arrow Mode or a Sequential Chevron Mode. A truck mounted advance warning arrow panel is recommended but not required on the Work Vehicle. However, if the Work Vehicle is NOT supplemented with a truck mounted advance warning arrow panel, then a truck mounted advance warning arrow panel operating in a Flashing Arrow Mode or a Sequential Chevron Mode is REQUIRED on the Shadow Vehicle.

DRAWING 535-04-D(1)
MOBILE OPERATIONS
INTERMITTENT
HIGH VOLUME
HIGH SPEED
INTERSTATE ROUTES

STOPPING SIGHT DISTANCE REQUIREMENTS			
POSTED REGULATORY SPEED LIMIT (A)	PASSENGER CAR DISTANCE (X)	TRUCK DISTANCE (X)	SHADOW VEHICLE to WORK VEHICLE DISTANCE (Y)
≤ 35 MPH	250 FEET	350 FEET	50-250 FEET
40 MPH to 55 MPH	500 FEET	750 FEET	75-500 FEET
60 MPH to 70 MPH	750 FEET	1100 FEET	100-750 FEET

CONSIDER USING THE DISTANCES DESIGNATED AS "TRUCK" ON ROADWAYS WITH HIGH TRUCK VOLUMES

- (A) - POSTED REGULATORY SPEED LIMIT
- (X) - STOPPING SIGHT DISTANCE INTERVAL
- (Y) - RECOMMENDED MINIMUM DISTANCE INTERVAL BETWEEN SHADOW VEHICLE AND WORK VEHICLE OR PEDESTRIAN WORKERS WHEN PEDESTRIAN WORKERS ARE PRESENT

GENERAL NOTES:

1. STOPPING SIGHT DISTANCE IS THE LENGTH OF ROADWAY NECESSARY FOR A VEHICLE TO STOP BEFORE REACHING A STATIONARY OBJECT OR SPECIFIC LOCATION IN ITS PATH.
2. UTILIZE A SHADOW VEHICLE TO ACCOMPANY THE WORK VEHICLE WHEN THE STOPPING SIGHT DISTANCE BETWEEN THE WORK VEHICLE AND AN APPROACHING MOTORIST IS UNAVAILABLE BASED UPON THE POSTED REGULATORY SPEED LIMIT.
3. WHEN UTILIZING A SHADOW VEHICLE, LOCATE THE SHADOW VEHICLE TO PROVIDE SUFFICIENT STOPPING SIGHT DISTANCE BETWEEN AN APPROACHING MOTORIST AND THE SHADOW VEHICLE.
4. THE WORK VEHICLE AND THE SHADOW VEHICLE SHOULD UTILIZE AND REMAIN WITHIN THE SHOULDER AREA AS MUCH AS PRACTICAL.
5. A SHADOW VEHICLE IS REQUIRED DURING ALL INTERMITTENT MOBILE OPERATIONS CONDUCTED DURING THE HOURS OF DARKNESS.
6. UNLESS OTHERWISE SPECIFICALLY DIRECTED BY THIS MANUAL, THE MAXIMUM TIME DURATION OF A STOP IS 5 MINUTES WHEN THE WORK VEHICLE AND/OR THE SHADOW VEHICLE MUST ENCROACH UPON A TRAVEL LANE DUE TO A SHOULDER AREA INADEQUATE TO ACCOMMODATE A VEHICLE IN ITS ENTIRETY DUE TO THE PRESENCE OF A CONCRETE MEDIAN BARRIER WALL, A BRIDGE PARAPET WALL OR GUARDRAIL.
7. THE MAXIMUM TIME DURATION OF A STOP IS 30 MINUTES IF ALL VEHICLES REMAIN IN THE SHOULDER AREA IN THEIR ENTIRETY WITH NO ENCROACHMENT UPON THE ADJACENT TRAVEL LANE.
8. A SHADOW VEHICLE MAY NOT BE NECESSARY DURING DAYTIME OPERATIONS WHEN THE WORK VEHICLE REMAINS WITHIN THE SHOULDER AREA IN ITS ENTIRETY AND ADEQUATE SIGHT DISTANCE IS AVAILABLE.
9. ENCROACHMENT UPON A TRAVEL LANE BY THE WORK VEHICLE WITHOUT A SHADOW VEHICLE IS UNACCEPTABLE UNLESS OTHERWISE DIRECTED BY THIS MANUAL.

INTERSTATE ROUTES

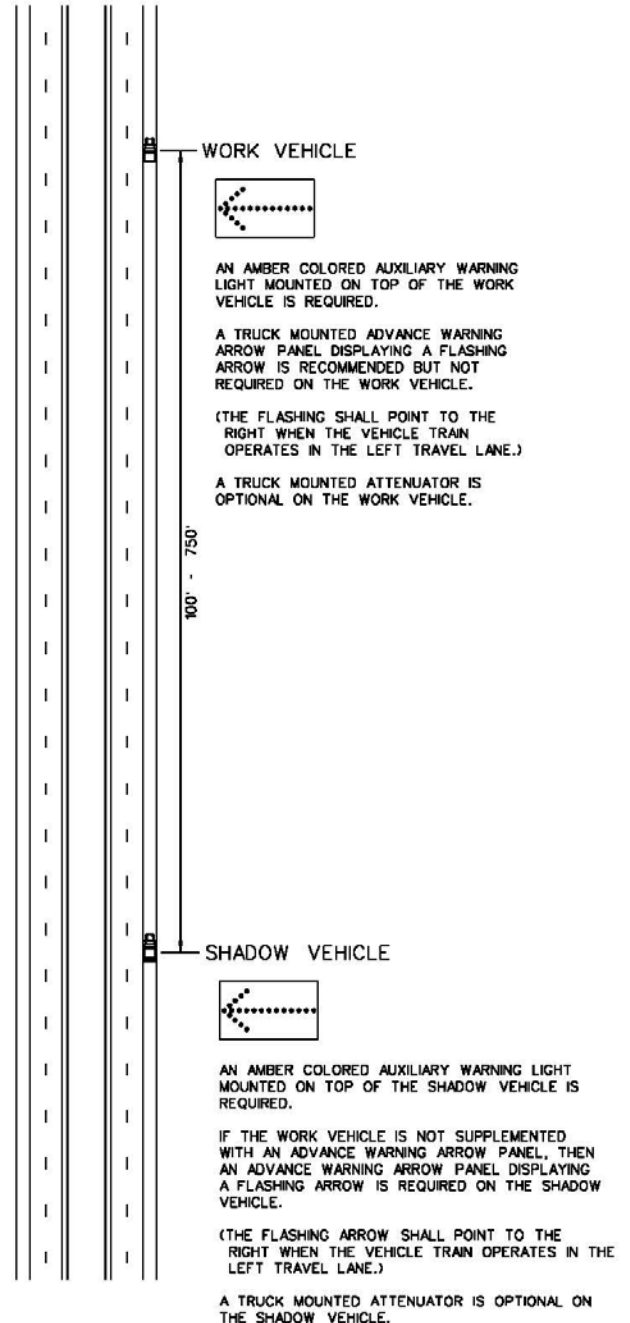

**MOBILE OPERATIONS
INTERMITTENT
PEDESTRIAN WORKERS
INTERSTATE ROUTES
(MAJOR ENCROACHMENT)**

1. Intermittent mobile operations, **(PEDESTRIAN WORKERS) / (MAJOR ENCROACHMENT)**, are mobile operations that involve frequent short stops with **MAXIMUM** time durations of **NO** more than 15 minutes. This traffic control setup applies to a short duration work zone within the limits of an interstate route that includes Pedestrian Workers and slowly progresses along the roadway, i.e. pothole patching.

Standard stationary lane closures are required for work activities that require Pedestrian Workers to encroach upon the limits of a travel lane for a time period greater than 15 minutes.

ONLY those work activities that can be completed within 15 minutes or less may be conducted under this traffic control setup.

2. Shadow vehicles **SHALL** accompany the Work Vehicle as illustrated at all times when Pedestrian Workers must conduct work activities within the limits of a travel lane. These operations **SHALL** include three (3) shadow vehicles.

First Travel Lane Shadow Vehicle - The First Travel Lane Shadow Vehicle shall operate in the same travel lane as the Work Vehicle and the Pedestrian Worker(s). The First Travel Lane Shadow Vehicle should maintain a distance interval of 100 feet to the rear of the location of the Pedestrian Worker(s). Equip the First Travel Lane Shadow Vehicle with a truck mounted attenuator and a truck mounted advance warning arrow panel operating in a flashing arrow mode.

Second Travel Lane Shadow Vehicle - The Second Travel Lane Shadow Vehicle shall operate in the same travel lane as the First Travel Lane Shadow Vehicle, the Work Vehicle and the Pedestrian Worker(s). The Second Travel Lane Shadow Vehicle should maintain a distance interval of approximately 100 feet to the rear of the First Travel Lane Shadow Vehicle. Equip the Second Travel Lane Shadow Vehicle with a truck mounted attenuator and a truck mounted advance warning arrow panel operating in a flashing arrow mode.

Shoulder Shadow Vehicle - The Shoulder Shadow Vehicle should maintain a distance interval of approximately 100 feet to the rear of the Second Travel Lane Shadow Vehicle. Equip the Shoulder Shadow Vehicle with a truck mounted attenuator and a truck mounted advance warning arrow panel operating in a flashing arrow mode. This vehicle should operate on the shoulder. However, the Shoulder Shadow Vehicle may operate in the same travel lane as the Work Vehicle when the shoulders are too narrow to accommodate vehicles, the shoulders are structurally inadequate or concrete barrier wall, cable guardrail or curb & gutter is present.

Truck Mounted Changeable Message Sign Vehicle - A truck mounted changeable message sign may be utilized in place of the advance warning sign array. The Truck Mounted Changeable Message Sign Vehicle should maintain a distance interval of approximately 2000 feet to the rear of the Shoulder Shadow Vehicle. Program the truck mounted changeable message sign to flash alternately to read "Right (Left) Lane", "Closed Ahead".

The Truck Mounted Changeable Message Sign Vehicle should operate on the shoulder. A truck mounted attenuator is not required on this truck when the gross vehicular weight of the truck is 5000 lbs. or less, otherwise, this truck shall have the necessary gross vehicular weight to accommodate a truck mounted attenuator.

In the event, the shoulders are too narrow to accommodate vehicles, the shoulders are structurally inadequate or concrete barrier wall, cable guardrail or curb & gutter is present, the Truck Mounted Changeable Message Sign Vehicle may be required to operate in the same travel lane as the Work Vehicle. **When the Truck Mounted Changeable Message Sign Vehicle is required to operate in the same travel lane as the Work Vehicle, utilize the proper size vehicle with the necessary gross vehicular weight to accommodate a truck mounted attenuator.** Also, when the Truck Mounted Changeable Message Sign Vehicle operates in the travel lane, the truck mounted changeable message sign **SHALL** display a Flashing Arrow. The Flashing Arrow mode is **ONLY** permitted when the Truck Mounted Changeable Message Sign Vehicle must operate in the travel lane.

3. The Resident Engineer may request the assistance of law enforcement when Pedestrian Workers are present and performing work operations within the limits of a travel lane of an interstate route.

4. Maintain two-way radio communication between all vehicles.

5. Supplement all vehicles operating in the vehicle train with amber colored auxiliary warning lights. The auxiliary warning lights shall be high intensity rotating, flashing, oscillating or strobe lights. Standard vehicle hazard warning lights are only permitted as a supplement to the auxiliary warning lights.

6. A truck mounted advance warning arrow panel operating in a Flashing Arrow Mode or a Sequential Chevron Mode is required on each Shadow Vehicle. A truck mounted advance warning arrow panel is recommended but not required on the Work Vehicle.

7. Utilize advance warning signs relative to the work zone site conditions. The "Worker" sign (W21-1-48) is required when Pedestrian Workers are present. Install a "Right (Left) Lane Closed Ahead" sign (W20-5R(L)-48-A) followed by the "Worker" sign (W21-1-48).

Due to the mobility of these operations, minimum traffic control requirements specify the installation of advance warning sign assemblies and the accompanying shadow vehicle(s). Install advance warning sign assemblies as illustrated. Relocate these advance warning sign assemblies or install additional advance warning sign assemblies as necessary as the work area advances along the roadway. Do not allow the Work Vehicle to advance beyond a two (2) mile increment from the "Worker" sign (W21-1-48) advance warning sign assembly at any time. Relocate the advance warning sign array as necessary to maintain the maximum two (2) mile increment.

The advance warning sign array may be replaced with a truck mounted changeable message sign programmed to flash alternately to read "Right (Left) Lane", "Closed Ahead". When a Truck Mounted Changeable Message Sign Vehicle is utilized, comply with the requirements of Note 2, Truck Mounted Changeable Message Sign Vehicle.

8. **On interstate routes, the minimum mounting height of the advance warning signs mounted on portable sign supports is 5 feet from the ground to the bottom edge of the sign.**

DRAWING 535-04-D(2)
MOBILE OPERATIONS
INTERMITTENT
PEDESTRIAN WORKERS
INTERSTATE ROUTES
(MAJOR ENCROACHMENT)

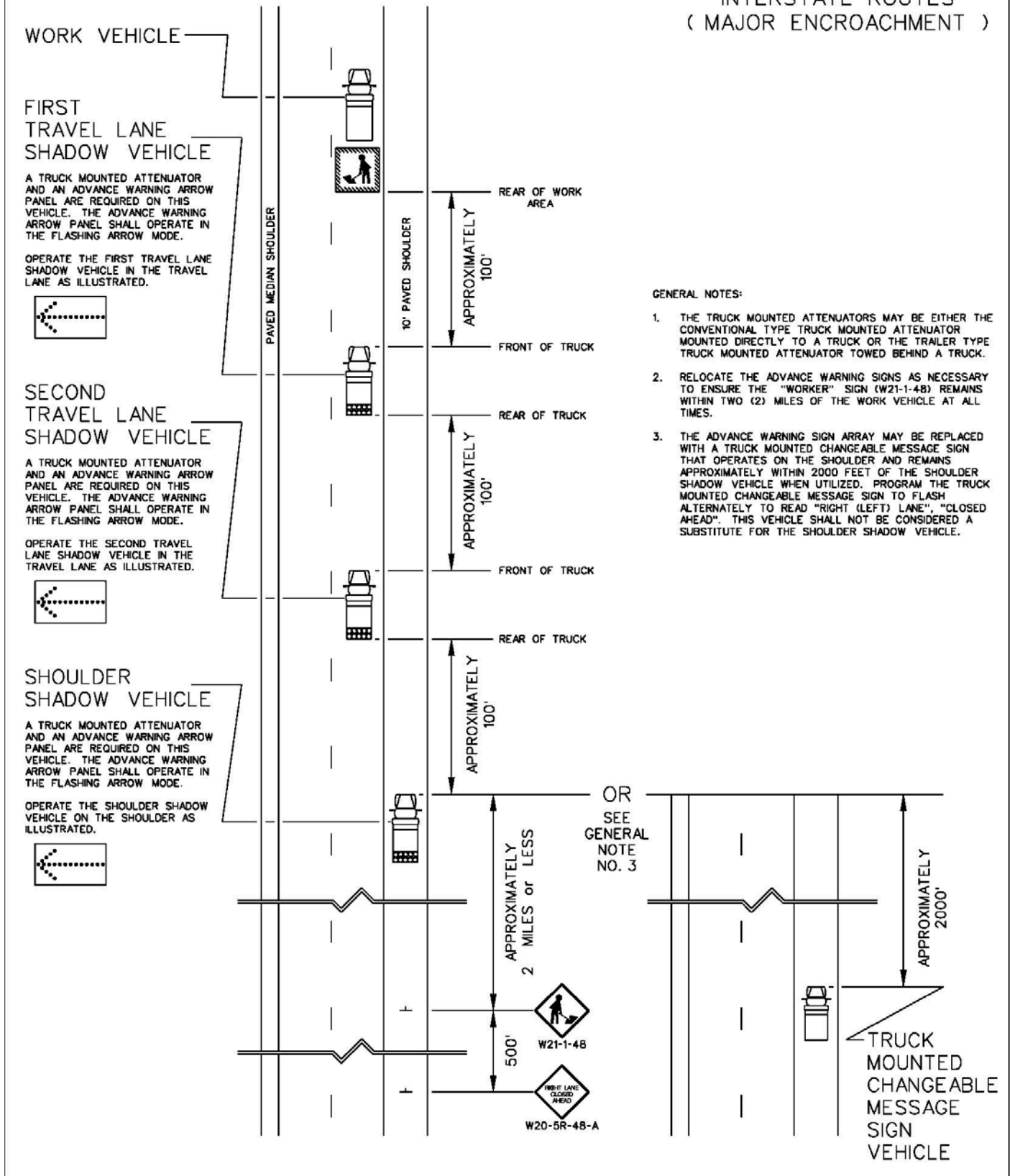

GENERAL NOTES:

1. THE TRUCK MOUNTED ATTENUATORS MAY BE EITHER THE CONVENTIONAL TYPE TRUCK MOUNTED ATTENUATOR MOUNTED DIRECTLY TO A TRUCK OR THE TRAILER TYPE TRUCK MOUNTED ATTENUATOR TOWED BEHIND A TRUCK.
2. RELOCATE THE ADVANCE WARNING SIGNS AS NECESSARY TO ENSURE THE "WORKER" SIGN (W21-1-48) REMAINS WITHIN TWO (2) MILES OF THE WORK VEHICLE AT ALL TIMES.
3. THE ADVANCE WARNING SIGN ARRAY MAY BE REPLACED WITH A TRUCK MOUNTED CHANGEABLE MESSAGE SIGN THAT OPERATES ON THE SHOULDER AND REMAINS APPROXIMATELY WITHIN 2000 FEET OF THE SHOULDER SHADOW VEHICLE WHEN UTILIZED. PROGRAM THE TRUCK MOUNTED CHANGEABLE MESSAGE SIGN TO FLASH ALTERNATELY TO READ "RIGHT (LEFT) LANE", "CLOSED AHEAD". THIS VEHICLE SHALL NOT BE CONSIDERED A SUBSTITUTE FOR THE SHOULDER SHADOW VEHICLE.

**MOBILE OPERATIONS
INTERMITTENT
HIGH VOLUME
HIGH SPEED
INTERIOR TRAVEL LANE OPERATIONS
INTERSTATE ROUTES**

1. Intermittent mobile operations are mobile operations that move at speeds less than 3 mph or involve frequent short stops.
2. The Resident Engineer should request the assistance of law enforcement when conducting intermittent mobile operations in an interior travel lane of an interstate route.
3. Roadway characteristics such as type, speed classification and volume classification shall determine the traffic control requirements for intermittent mobile operations. **A shadow vehicle is REQUIRED and SHALL accompany the work vehicle during ALL intermittent mobile operations conducted within an interior travel lane.** The shadow vehicle should operate at close range behind the work vehicle while maintaining adequate stopping sight distance to minimize encroachment by motorists between the work vehicle and the shadow vehicle when operating in an interior travel lane.

Interstate Routes

- A. The maximum time duration of a stop is 5 minutes when the work vehicle and the shadow vehicle operate adjacent to a concrete median barrier wall, a bridge parapet wall or guardrail, the shoulder area is inadequate to accommodate a vehicle in its entirety or the work vehicle and the shadow vehicle are required to encroach upon the adjacent travel lane.
 - B. A shadow vehicle is required for all work operations within an interior travel lane. Operating a work vehicle in an interior travel lane without a shadow vehicle is PROHIBITED.
4. On high volume high speed roadways, intermittent mobile operations should be conducted with no less than 2 persons in the work vehicle. One person shall act as a spotter while the other person performs the work. **Evaluate the potential sight distance restrictions and posted regulatory speed limits of these roadways prior to deployment of the work detail to determine the minimum vehicle train requirements.**
 5. Maintain two-way radio communication between all vehicles when more than 1 vehicle is utilized.
 6. Supplement all vehicles operating in the vehicle train with amber colored auxiliary warning lights. The auxiliary warning lights shall be high intensity rotating, flashing, oscillating or strobe lights. Standard vehicle hazard warning lights are only permitted as a supplement to the auxiliary warning lights.
 7. A truck mounted advance warning arrow panel operating in a Flashing Arrow Mode or a Sequential Chevron Mode is required on the Work Vehicle and the Shadow Vehicle.

STOPPING SIGHT DISTANCE REQUIREMENTS

POSTED REGULATORY SPEED LIMIT (A)	PASSENGER CAR DISTANCE (X)	TRUCK DISTANCE (X)	SHADOW VEHICLE to WORK VEHICLE DISTANCE (Y)
≤ 35 MPH	250 FEET	350 FEET	50-250 FEET
40 MPH to 55 MPH	500 FEET	750 FEET	75-500 FEET
60 MPH to 70 MPH	750 FEET	1100 FEET	100-750 FEET

CONSIDER USING THE DISTANCES DESIGNATED AS "TRUCK" ON ROADWAYS WITH HIGH TRUCK VOLUMES

(A) - POSTED REGULATORY SPEED LIMIT

(X) - STOPPING SIGHT DISTANCE INTERVAL

(Y) - RECOMMENDED MINIMUM DISTANCE INTERVAL BETWEEN SHADOW VEHICLE AND WORK VEHICLE OR PEDESTRIAN WORKERS WHEN PEDESTRIAN WORKERS ARE PRESENT

DRAWING 535-04-E
MOBILE OPERATIONS
INTERMITTENT
HIGH VOLUME
HIGH SPEED
INTERIOR TRAVEL LANE
OPERATIONS
INTERSTATE ROUTES

GENERAL NOTES:

1. STOPPING SIGHT DISTANCE IS THE LENGTH OF ROADWAY NECESSARY FOR A VEHICLE TO STOP BEFORE REACHING A STATIONARY OBJECT OR SPECIFIC LOCATION IN ITS PATH.
2. A SHADOW VEHICLE IS REQUIRED DURING ALL INTERMITTENT MOBILE OPERATIONS CONDUCTED WITHIN AN INTERIOR TRAVEL LANE.
3. WHEN UTILIZING A SHADOW VEHICLE, LOCATE THE SHADOW VEHICLE TO PROVIDE SUFFICIENT STOPPING SIGHT DISTANCE BETWEEN AN APPROACHING MOTORIST AND THE SHADOW VEHICLE.
4. WHEN THE VEHICLE TRAIN OPERATES WITHIN AN INTERIOR TRAVEL LANE ADJACENT TO A SHOULDER, (i.e. LEFT TRAVEL LANE / LEFT SHOULDER), THE WORK VEHICLE AND THE SHADOW VEHICLE SHOULD UTILIZE AND REMAIN WITHIN THE SHOULDER AREAS AS MUCH AS PRACTICAL.
5. THE MAXIMUM TIME DURATION OF A STOP IS 5 MINUTES WHEN THE VEHICLE TRAIN OPERATES WITHIN AN INTERIOR TRAVEL LANE.
6. A SHADOW VEHICLE IS REQUIRED DURING ALL INTERMITTENT MOBILE OPERATIONS CONDUCTED DURING THE HOURS OF DARKNESS.
7. THE RESIDENT ENGINEER SHOULD REQUEST THE ASSISTANCE OF LAW ENFORCEMENT WHEN CONDUCTING INTERMITTENT MOBILE OPERATIONS WITHIN AN INTERIOR TRAVEL LANE OF AN INTERSTATE ROUTE.

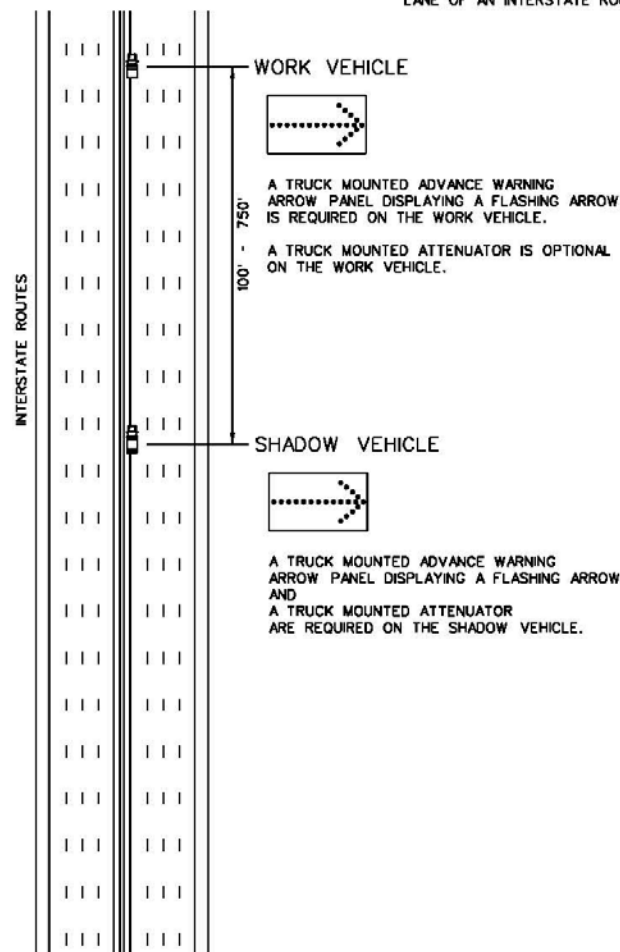

MOBILE OPERATIONS

CONTINUOUS

STANDARD DRAWING NO. 540-01

Through

STANDARD DRAWING NO. 540-04-B

**MOBILE OPERATIONS
CONTINUOUS
TWO-LANE TWO-WAY ROADWAYS
PRIMARY & SECONDARY ROUTES**

1. Continuously moving mobile operations are work activities that move continuously at all times at speeds greater than 3 mph without any stops.

2. Where variable distance intervals are indicated in the illustration, adjust the distance intervals between the vehicles to compensate for sight distance obstructions created by hills and curves and any other conditions that may obstruct the sight distance between the vehicles. However, adjustments to the distance intervals between the vehicles are restricted to the range of variable distance intervals indicated in the illustration.

3. The lead vehicle is optional in this vehicle train. When utilized, the lead vehicle should maintain a distance interval of 100 feet to 500 feet ahead of the work vehicle. Equip the lead vehicle with a 24 inch X 30 inch "Keep Right" sign (R4-7a-24) mounted on the front of the vehicle facing oncoming traffic.

4. Equip the work vehicle with a truck mounted advance warning arrow panel operating in the "Four Corner" Caution Mode facing traffic approaching the work vehicle from the rear. The work vehicle may be supplemented with a truck mounted attenuator.

When the lead vehicle is omitted, supplement the first work vehicle in the vehicle train with a 24 inch X 30 inch "Keep Right" sign (R4-7a-24) mounted on the front of the vehicle facing oncoming traffic.

5. The primary shadow vehicle should maintain a distance interval of 150 feet to 300 feet to the rear of the work vehicle. Equip the primary shadow vehicle with a truck mounted advance warning arrow panel operating in the "Four Corner" Caution Mode and a truck mounted attenuator.

6. The vehicle train may be supplemented with a second shadow vehicle. The second shadow vehicle is optional but the second shadow vehicle shall comply with following requirements when utilized. The second shadow vehicle should maintain a distance interval of 500 feet to 1000 feet to the rear of the primary shadow vehicle. Equip the second shadow vehicle with a truck mounted advance warning arrow panel operating in the "Four Corner" Caution Mode and a truck mounted attenuator.

7. Maintain two-way radio communication between all vehicles in the vehicle train operating in this continuously moving mobile operation.

8. Supplement all vehicles and equipment operating in the vehicle train with amber colored auxiliary warning lights. The auxiliary warning lights shall be high intensity rotating, flashing, oscillating or strobe lights. Standard vehicle hazard warning lights are only permitted as a supplement to the auxiliary warning lights.

DRAWING 540-01
 MOBILE OPERATIONS
 CONTINUOUS
 TWO-LANE TWO-WAY ROADWAYS
 PRIMARY & SECONDARY
 ROUTES

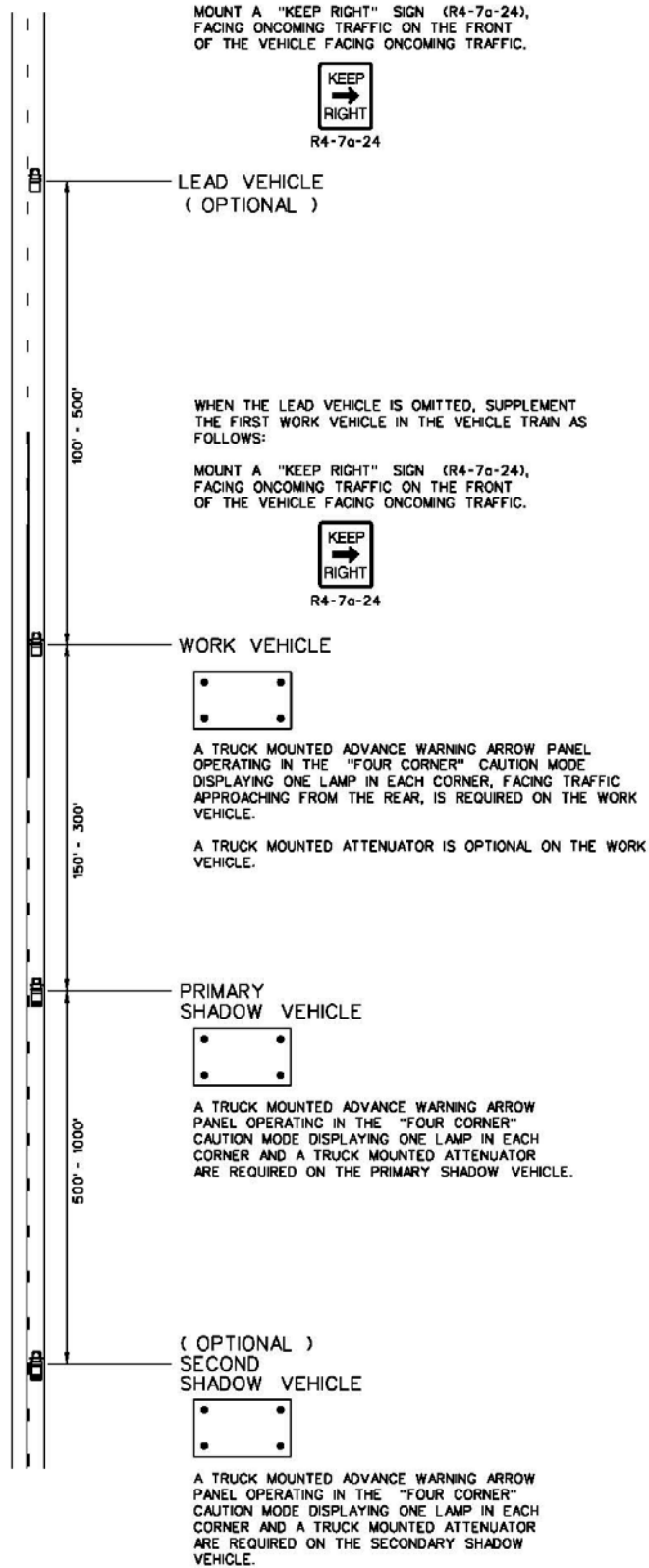

Drawing No. 540-02-A
540-02-B

**MOBILE OPERATIONS
CONTINUOUS
MULTILANE
PRIMARY & SECONDARY ROUTES
EARTH MEDIAN w/ GRASSED OR PAVED SHOULDERS / PAVED MEDIAN w/ CURB & GUTTER**

1. Continuously moving mobile operations are work activities that move continuously at all times at speeds greater than 3 mph without any stops.
2. Where variable distance intervals are indicated in the illustration, adjust the distance intervals between the vehicles to compensate for sight distance obstructions created by hills and curves and any other conditions that may obstruct the sight distance between the vehicles. However, adjustments to the distance intervals between the vehicles are restricted to the range of variable distance intervals indicated in the illustration.
3. Equip the work vehicle with a truck mounted advance warning arrow panel displaying a flashing arrow. The work vehicle may be supplemented with a truck mounted attenuator.
4. A shadow vehicle should maintain a distance interval of 150 feet to 300 feet to the rear of the work vehicle. Equip the shadow vehicle with a truck mounted advance warning arrow panel displaying a flashing arrow and a truck mounted attenuator. The shadow vehicle shall operate in the same travel lane as the work vehicle.
5. The vehicle train may be supplemented with a second shadow vehicle. The second shadow vehicle is optional but the second shadow vehicle shall comply with following requirements when utilized. The second shadow vehicle should maintain a distance interval to the rear of the first shadow vehicle as specified in the "Table for Variable Distance Intervals" included in the illustrations. Equip the second shadow vehicle with a truck mounted advance warning arrow panel displaying a flashing arrow and a truck mounted attenuator. The second shadow vehicle should operate in the adjacent shoulder area when sufficient shoulder space is available. **During mobile operations in the left travel lane, avoid placement of the second shadow vehicle in a paved median where opposing left turn traffic may be encountered.**
6. Maintain two-way radio communication between all vehicles in the vehicle train operating in this continuously moving mobile operation.
7. Supplement all vehicles and equipment operating in the vehicle train with amber colored auxiliary warning lights. The auxiliary warning lights shall be high intensity rotating, flashing, oscillating or strobe lights. Standard vehicle hazard warning lights are only permitted as a supplement to the auxiliary warning lights.

DRAWING 540-02-A
MOBILE OPERATIONS
CONTINUOUS
MULTILANE
PRIMARY & SECONDARY ROUTES
EARTH MEDIAN w/
GRASSED OR PAVED SHOULDERS

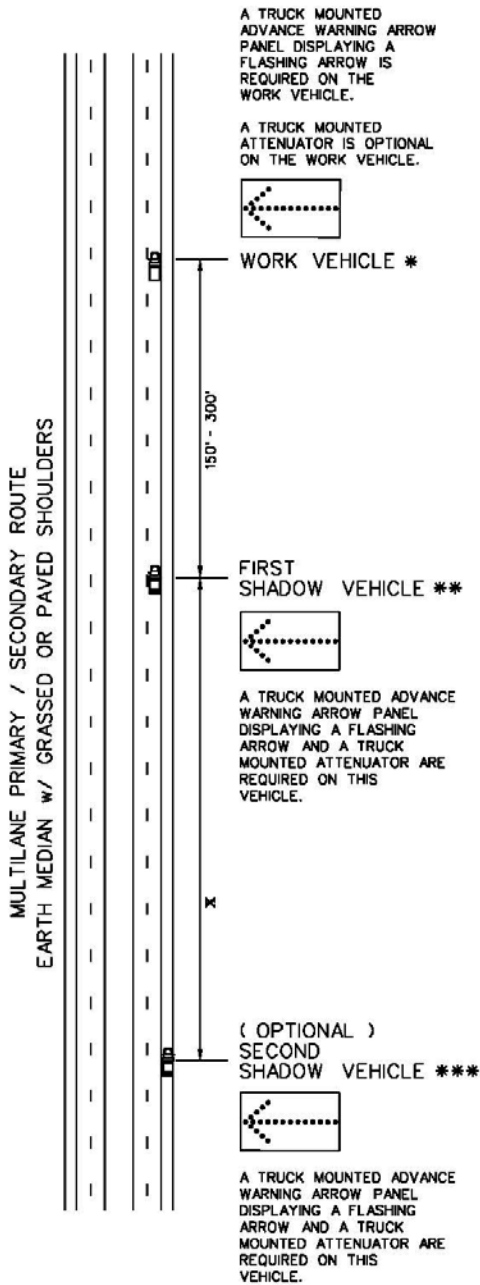

LEFT LANE CLOSURE

- * LEFT LANE CLOSURE WORK VEHICLE
 - 1.) THE FLASHING ARROW SHALL POINT TO THE RIGHT.
- ** LEFT LANE CLOSURE FIRST SHADOW VEHICLE
 - 1.) THE FLASHING ARROW SHALL POINT TO THE RIGHT.
- *** LEFT LANE CLOSURE SECOND SHADOW VEHICLE
 - 1.) THE FLASHING ARROW SHALL POINT TO THE RIGHT.
 - 2.) PLACE THE VEHICLE ON THE LEFT SHOULDER DURING LEFT LANE CLOSURES WHEN SUFFICIENT SHOULDER SPACE IS AVAILABLE AND THE LEFT SHOULDER IS STRUCTURALLY SOUND. WHEN SUFFICIENT LEFT SHOULDER SPACE IS UNAVAILABLE OR THE LEFT SHOULDER AREA IS STRUCTURALLY INADEQUATE, THE SECOND SHADOW VEHICLE SHALL OPERATE IN THE LEFT TRAVEL LANE. DO NOT PLACE THE SECOND SHADOW VEHICLE IN A PAVED MEDIAN WHERE OPPOSING LEFT TURN TRAFFIC MAY BE ENCOUNTERED.

TABLE for VARIABLE DISTANCE INTERVALS

X - THE DISTANCE INTERVAL RANGE BETWEEN THE FIRST SHADOW VEHICLE AND THE SECOND SHADOW VEHICLE.

SPEED LIMIT	X
45 MPH or LESS	250' - 500'
50 MPH or GREATER	500' - 1000'

DRAWING 540-02-B
MOBILE OPERATIONS
CONTINUOUS
MULTILANE
PRIMARY & SECONDARY ROUTES
PAVED MEDIAN w/
CURB & GUTTER

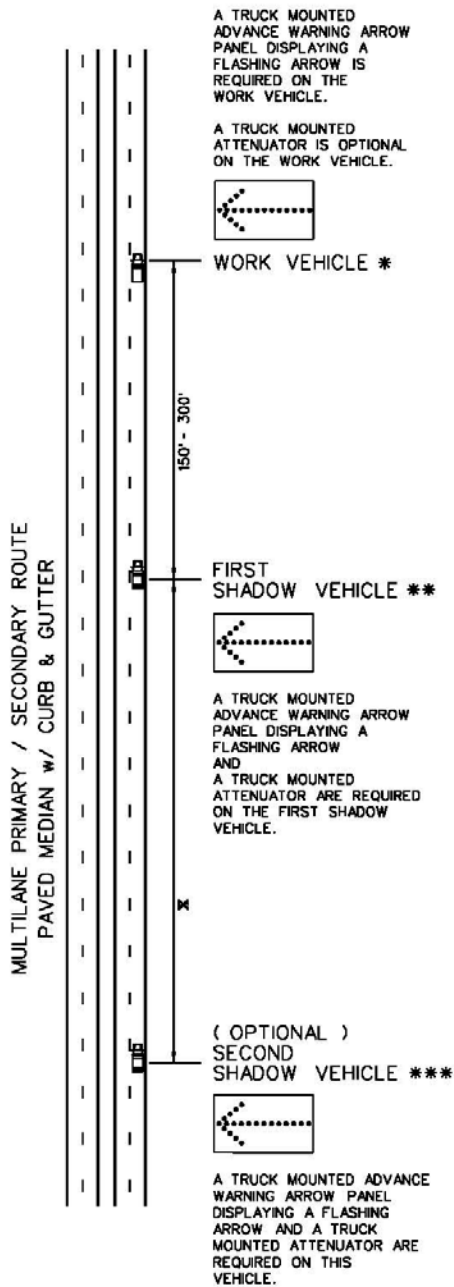

LEFT LANE CLOSURE

- * LEFT LANE CLOSURE WORK VEHICLE
 - 1.) THE FLASHING ARROW SHALL POINT TO THE RIGHT.
- ** LEFT LANE CLOSURE FIRST SHADOW VEHICLE
 - 1.) THE FLASHING ARROW SHALL POINT TO THE RIGHT.
- *** LEFT LANE CLOSURE SECOND SHADOW VEHICLE
 - 1.) THE FLASHING ARROW SHALL POINT TO THE RIGHT.
 - 2.) THE SECOND SHADOW VEHICLE SHALL OPERATE IN THE LEFT TRAVEL LANE WHEN CURB & GUTTER IS PRESENT.

TABLE for VARIABLE DISTANCE INTERVALS

X - THE DISTANCE INTERVAL RANGE BETWEEN THE FIRST SHADOW VEHICLE AND THE SECOND SHADOW VEHICLE.

SPEED LIMIT	X
45 MPH or LESS	250' - 500'
50 MPH or GREATER	500' - 1000'

**MOBILE OPERATIONS
CONTINUOUS
INTERSTATE ROUTES
RIGHT TRAVEL LANE / LEFT TRAVEL LANE**

1. Continuously moving mobile operations are work activities that move continuously at all times at speeds greater than 3 mph without any stops.
2. Where variable distance intervals are indicated in the illustration, adjust the distance intervals between the vehicles to compensate for sight distance obstructions created by hills and curves and any other conditions that may obstruct the sight distance between the vehicles. However, adjustments to the distance intervals between the vehicles are restricted to the range of variable distance intervals indicated in the illustration.
3. Equip the work vehicle with a truck mounted advance warning arrow panel displaying a flashing arrow. The work vehicle may be supplemented with a truck mounted attenuator.
4. The first shadow vehicle should maintain a distance interval of 250 feet to 500 feet to the rear of the work vehicle. The first shadow vehicle shall operate in the same travel lane as the work vehicle. Equip the first shadow vehicle with a truck mounted advance warning arrow panel displaying a flashing arrow and a truck mounted attenuator.
5. The second shadow vehicle should maintain a distance interval of 750 feet to 2000 feet to the rear of the first shadow vehicle. Operate the second shadow vehicle on the adjacent shoulder where paved shoulders wide enough to accommodate vehicles are present or within the same travel lane as the first shadow vehicle when the paved shoulders are too narrow to accommodate vehicles, the shoulders are structurally inadequate or curb and gutter is present. Equip the second shadow vehicle with a truck mounted advance warning arrow panel displaying a flashing arrow and a truck mounted attenuator.
If a third shadow vehicle is utilized in the vehicle train, operate the second shadow vehicle in the same travel lane as the work vehicle and the first shadow vehicle.
6. The vehicle train may be supplemented with a third shadow vehicle. The third shadow vehicle is optional but the third shadow vehicle shall comply with following requirements when utilized. The third shadow vehicle should maintain a distance interval of 750 feet to 2000 feet to the rear of the second shadow vehicle. Operate the third shadow vehicle on the right paved shoulder or within an active travel as specified hereby.
Equip the third shadow vehicle with a truck mounted attenuator.
Equip the third shadow vehicle with a truck mounted changeable message sign.

Truck Mounted Changeable Message Sign – The truck mounted changeable message sign shall flash alternately to read “RIGHT LANE”, “CLOSED AHEAD” during operations in the right travel lane or “LEFT LANE”, “CLOSED AHEAD” during operations in the left travel lane. The truck mounted changeable message sign shall display messages with a minimum character height of 18 inches.

The truck mounted changeable message sign shall display a flashing arrow when operating in an active travel lane.

The third shadow shall operate in the same travel lane as the second shadow vehicle in the event the shoulder area cannot accommodate the third shadow vehicle due to insufficient shoulder space, structural inadequacy of the shoulder or the presence of curb and gutter.
7. Maintain two-way radio communication between all vehicles in the vehicle train operating in this continuously moving mobile operation.
8. Supplement all vehicles and equipment operating in the vehicle train with amber colored auxiliary warning lights. The auxiliary warning lights shall be high intensity rotating, flashing, oscillating or strobe lights. Standard vehicle hazard warning lights are only permitted as a supplement to the auxiliary warning lights.

DRAWING 540-03-A
MOBILE OPERATIONS
CONTINUOUS
INTERSTATE ROUTES
RIGHT TRAVEL LANE

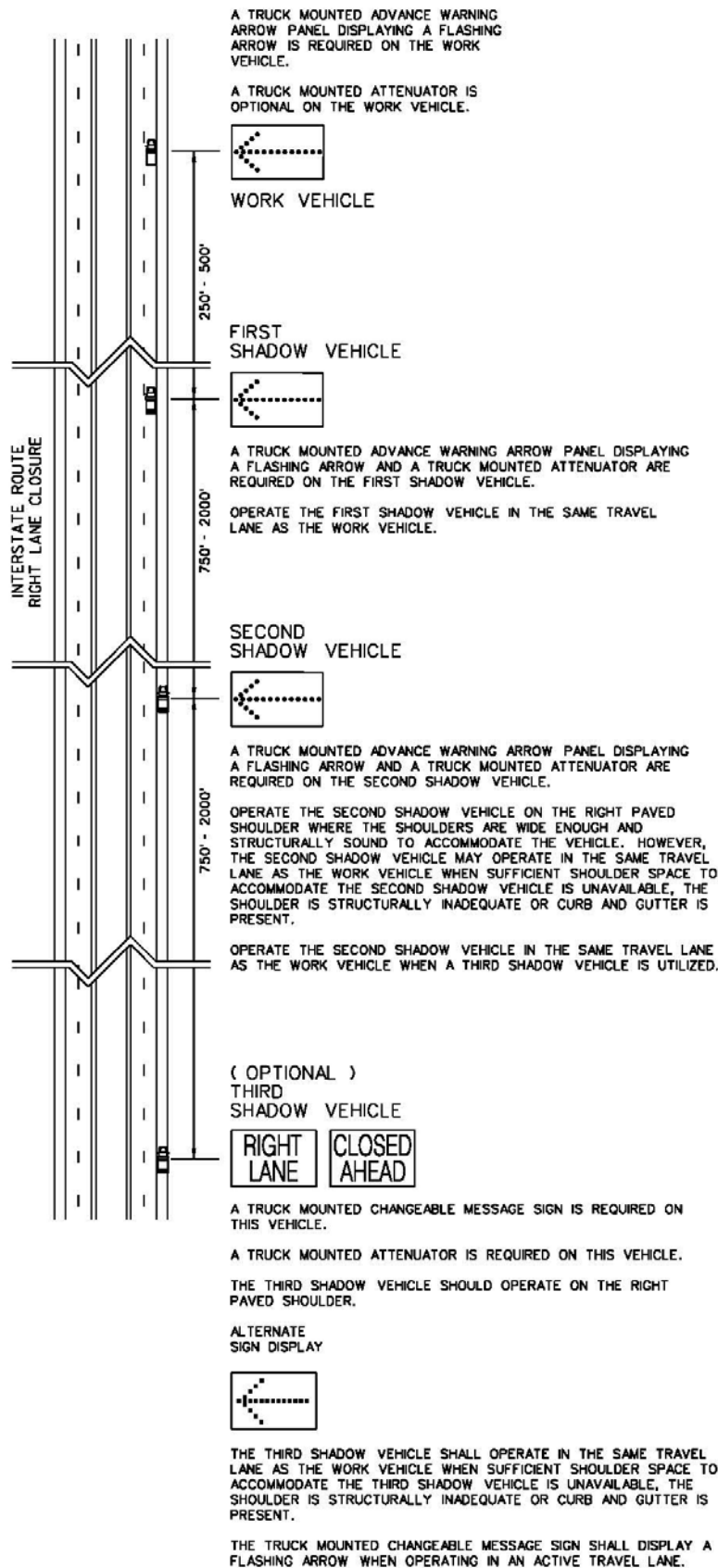

DRAWING 540-03-B
MOBILE OPERATIONS
CONTINUOUS
INTERSTATE ROUTES
LEFT TRAVEL LANE

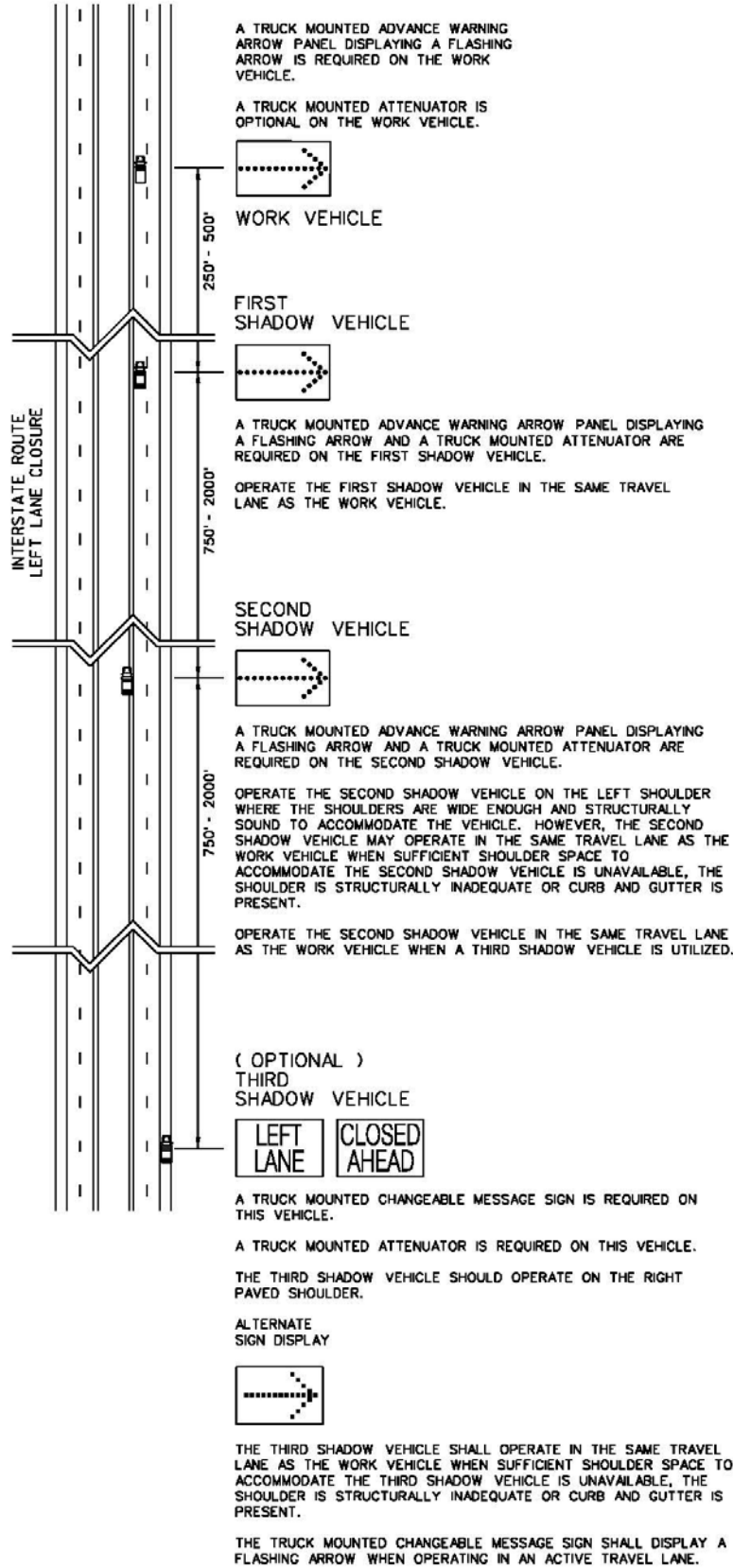

**MOBILE OPERATIONS
CONTINUOUS
DUAL LANE CLOSURES
INTERIOR TRAVEL LANE OPERATIONS
INTERSTATE ROUTES
RIGHT TRAVEL LANES / LEFT TRAVEL LANES**

1. Continuously moving mobile operations are work activities that move continuously at all times at speeds greater than 3 mph without any stops.
2. Where variable distance intervals are indicated in the illustration, adjust the distance intervals between the vehicles to compensate for sight distance obstructions created by hills and curves and any other conditions that may obstruct the sight distance between the vehicles. However, adjustments to the distance intervals between the vehicles are restricted to the range of variable distance intervals indicated in the illustration.
3. Equip the work vehicle with a truck mounted advance warning arrow panel displaying a flashing arrow. The work vehicle may be supplemented with a truck mounted attenuator.
4. The first shadow vehicle should maintain a distance interval of 250 feet to 500 feet to the rear of the work vehicle. Equip the first shadow vehicle with a truck mounted advance warning arrow panel displaying a flashing arrow and a truck mounted attenuator. The first shadow vehicle shall operate in the same travel lane as the work vehicle.
5. The second shadow vehicle should maintain a distance interval of 750 feet to 2000 feet to the rear of the first shadow vehicle. Equip the second shadow vehicle with a truck mounted advance warning arrow panel displaying a flashing arrow and a truck mounted attenuator. The second shadow vehicle shall operate in the travel lane adjacent to the travel lane the first shadow vehicle is operating in.
6. The third shadow vehicle should maintain a distance interval of 750 feet to 2000 feet to the rear of the second shadow vehicle. Equip the third shadow vehicle with a truck mounted attenuator. Operate the third shadow vehicle on the right paved shoulder or within an active travel as specified hereby. Equip the third shadow vehicle with either a truck mounted advance warning arrow panel or a truck mounted changeable message sign.

Truck Mounted Advance Warning Arrow Panel – The truck mounted advance warning arrow panel shall operate in the Flashing Arrow Mode displaying a flashing arrow.

Truck Mounted Changeable Message Sign – The truck mounted changeable message sign shall flash alternately to read “RIGHT 2 LANES”, “CLOSED AHEAD” during operations in the two right travel lanes or “LEFT 2 LANES”, “CLOSED AHEAD” during operations in the two left travel lanes. The truck mounted changeable message sign shall display messages with a minimum character height of 18 inches.

The truck mounted changeable message sign shall display a flashing arrow when operating in an active travel lane.

The third shadow shall operate in the same travel lane as the second shadow vehicle in the event the shoulder area cannot accommodate the third shadow vehicle due to insufficient shoulder space, structural inadequacy of the shoulder or the presence of curb and gutter.

7. Maintain two-way radio communication between all vehicles in the vehicle train operating in this continuously moving mobile operation.
8. Supplement all vehicles and equipment operating in the vehicle train with amber colored auxiliary warning lights. The auxiliary warning lights shall be high intensity rotating, flashing, oscillating or strobe lights. Standard vehicle hazard warning lights are only permitted as a supplement to the auxiliary warning lights.

DRAWING 540-04-A
MOBILE OPERATIONS
CONTINUOUS
DUAL LANE CLOSURE
INTERIOR TRAVEL LANE
OPERATIONS
INTERSTATE ROUTES
RIGHT TRAVEL LANES

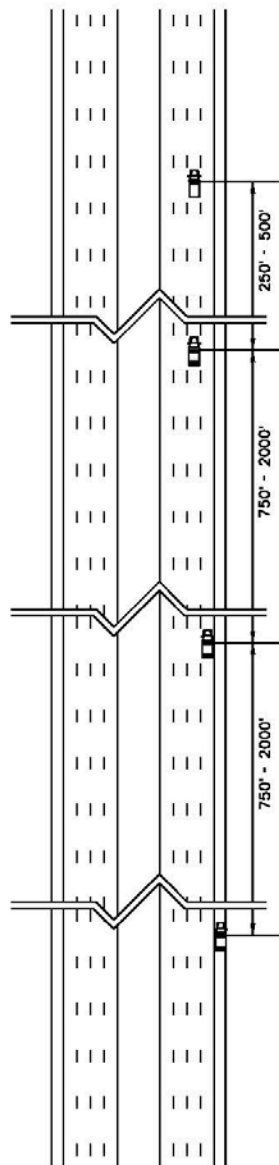

A TRUCK MOUNTED ADVANCE WARNING ARROW PANEL DISPLAYING A FLASHING ARROW IS REQUIRED ON THIS VEHICLE.

A TRUCK MOUNTED ATTENUATOR IS OPTIONAL ON THE WORK VEHICLE.

OPERATE THIS VEHICLE IN AN INTERIOR TRAVEL LANE.

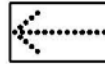

WORK VEHICLE

FIRST SHADOW VEHICLE

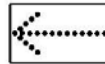

A TRUCK MOUNTED ADVANCE WARNING ARROW PANEL DISPLAYING A FLASHING ARROW AND A TRUCK MOUNTED ATTENUATOR ARE REQUIRED ON THE FIRST SHADOW VEHICLE.

OPERATE THE FIRST SHADOW VEHICLE IN THE SAME TRAVEL LANE AS THE WORK VEHICLE.

SECOND SHADOW VEHICLE



A TRUCK MOUNTED ADVANCE WARNING ARROW PANEL DISPLAYING A FLASHING ARROW AND A TRUCK MOUNTED ATTENUATOR ARE REQUIRED ON THE SECOND SHADOW VEHICLE.

OPERATE THE SECOND SHADOW VEHICLE IN THE ADJACENT TRAVEL LANE TO THE RIGHT OF THE TRAVEL LANE THE WORK VEHICLE AND THE FIRST SHADOW VEHICLE ARE OPERATING IN.

THIRD SHADOW VEHICLE



A TRUCK MOUNTED CHANGEABLE MESSAGE SIGN OR AN ADVANCE WARNING ARROW PANEL MAY BE UTILIZED ON THIS VEHICLE.

A TRUCK MOUNTED ATTENUATOR IS REQUIRED ON THIS VEHICLE.

THE THIRD SHADOW VEHICLE SHOULD OPERATE ON THE RIGHT PAVED SHOULDER.

ALTERNATE SIGN DISPLAY



THE THIRD SHADOW VEHICLE SHALL OPERATE IN THE ADJACENT TRAVEL LANE TO THE RIGHT OF THE TRAVEL LANE THE WORK VEHICLE AND THE FIRST SHADOW VEHICLE ARE OPERATING IN WHEN SUFFICIENT SHOULDER SPACE TO ACCOMMODATE THE THIRD SHADOW VEHICLE IS UNAVAILABLE, THE SHOULDER IS STRUCTURALLY INADEQUATE OR CURB AND GUTTER IS PRESENT.

THE TRUCK MOUNTED CHANGEABLE MESSAGE SIGN SHALL DISPLAY A FLASHING ARROW WHEN OPERATING IN AN ACTIVE TRAVEL LANE.

DRAWING 540-04-B
MOBILE OPERATIONS
CONTINUOUS
DUAL LANE CLOSURE
INTERIOR TRAVEL LANE
OPERATIONS
INTERSTATE ROUTES
LEFT TRAVEL LANES

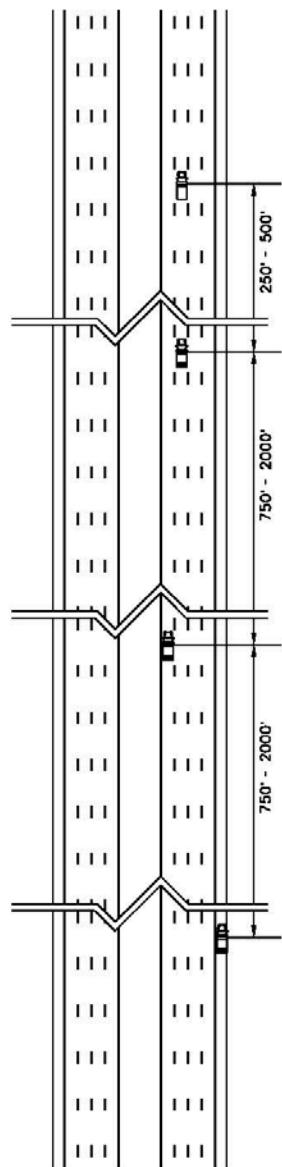

A TRUCK MOUNTED ADVANCE WARNING ARROW PANEL DISPLAYING A FLASHING ARROW IS REQUIRED ON THIS VEHICLE.

A TRUCK MOUNTED ATTENUATOR IS OPTIONAL ON THE WORK VEHICLE.

OPERATE THIS VEHICLE IN AN INTERIOR TRAVEL LANE.

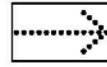

WORK VEHICLE

FIRST SHADOW VEHICLE



A TRUCK MOUNTED ADVANCE WARNING ARROW PANEL DISPLAYING A FLASHING ARROW AND A TRUCK MOUNTED ATTENUATOR ARE REQUIRED ON THE FIRST SHADOW VEHICLE.

OPERATE THE FIRST SHADOW VEHICLE IN THE SAME TRAVEL LANE AS THE WORK VEHICLE.

SECOND SHADOW VEHICLE



A TRUCK MOUNTED ADVANCE WARNING ARROW PANEL DISPLAYING A FLASHING ARROW AND A TRUCK MOUNTED ATTENUATOR ARE REQUIRED ON THE SECOND SHADOW VEHICLE.

OPERATE THE SECOND SHADOW VEHICLE IN THE ADJACENT TRAVEL LANE TO THE LEFT OF THE TRAVEL LANE THE WORK VEHICLE AND THE FIRST SHADOW VEHICLE ARE OPERATING IN.

THIRD SHADOW VEHICLE

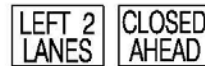

A TRUCK MOUNTED CHANGEABLE MESSAGE SIGN OR AN ADVANCE WARNING ARROW PANEL MAY BE UTILIZED ON THIS VEHICLE.

A TRUCK MOUNTED ATTENUATOR IS REQUIRED ON THIS VEHICLE.

THE THIRD SHADOW VEHICLE SHOULD OPERATE ON THE RIGHT PAVED SHOULDER.

ALTERNATE SIGN DISPLAY



THE THIRD SHADOW VEHICLE SHALL OPERATE IN THE ADJACENT TRAVEL LANE TO THE LEFT OF THE TRAVEL LANE THE WORK VEHICLE AND THE FIRST SHADOW VEHICLE ARE OPERATING IN WHEN SUFFICIENT SHOULDER SPACE TO ACCOMMODATE THE THIRD SHADOW VEHICLE IS UNAVAILABLE, THE SHOULDER IS STRUCTURALLY INADEQUATE OR CURB AND GUTTER IS PRESENT.

THE TRUCK MOUNTED CHANGEABLE MESSAGE SIGN SHALL DISPLAY A FLASHING ARROW WHEN OPERATING IN AN ACTIVE TRAVEL LANE.

TRAFFIC SIGNAL WORK OPERATIONS

SIGNAL HEADS

STANDARD DRAWING NO. 605-01-A

Through

STANDARD DRAWING NO. 605-05-B(2)

**TRAFFIC SIGNAL
WORK OPERATIONS
VEHICLE TRAIN
TWO-LANE TWO-WAY ROADWAY
PRIMARY & SECONDARY ROUTES
TRAFFIC SIGNAL WORK ACTIVITIES
COMPLETED IN 15 MINUTES OR LESS**

1. This traffic control setup is restricted to traffic signal work activities conducted on two-lane two-way roadways that requires the work vehicle to operate in the travel lane in its entirety and does not exceed 15 minutes.
This traffic control setup requires a work vehicle and a single flagger or a uniformed law enforcement officer.
When a single flagger is present to control the traffic, place the traffic signal on "normal flashing operations".
When a uniformed law enforcement officer is present to control the traffic, the traffic signal may or may not be placed on "normal flashing operations".
Due to the brevity and proximity of the work operation to the traffic signal, advance warning signs relative to a flagging operation are not required for this traffic control setup.
A shadow vehicle is optional.
2. If the work vehicle operates in the shoulder area, see the requirements for Intermittent Mobile Operations. When operating on low speed to high speed roadways with intermediate traffic volumes, see Drawing Nos. 535-03-A and 535-03-B and when operating on high speed roadways with high traffic volumes see Drawing Nos. 535-04-A and 535-04-C.
3. Avoid conducting traffic signal work or similar work activities that interfere with or create disruptions to normal traffic operations during high traffic volume peak periods when possible.
4. The vehicle train shall include the work vehicle.
A shadow vehicle is optional. When utilizing a shadow vehicle, a truck mounted advance warning arrow panel operating in the "Four Corner" Caution Mode with one lamp in each corner supplementing the shadow vehicle is optional. A truck mounted attenuator supplementing the shadow vehicle is optional.
Operate the shadow vehicle in the same travel lane as the work vehicle on the approach to the intersection without encroaching into the intersection.
5. A single flagger or a uniformed law enforcement officer is required to control the traffic utilizing the open travel lane adjacent to the work vehicle. The single flagger should stand on or immediately adjacent to the shoulder of the opposing travel lane where adequate sight distance is available to motorists entering the intersection from all approaches to provide for reasonably safe handling of the traffic.
6. Traffic signal work activities conducted under this traffic control setup are restricted to a duration not to exceed 15 minutes. Vacate the intersection in its entirety of all work vehicles, traffic control devices, material and/or personnel immediately upon reaching the end of the 15 minute time period. The intersection, including up to within 500 feet on each approach to the intersection, shall remain clear of all work vehicles, traffic control devices, material and/or personnel for no less than 15 minutes prior to beginning a subsequent traffic signal work activity within these specified limits of the intersection under this traffic control setup.
7. Conduct all equipment and material preparations prior to entering the roadway.
8. Supplement the work vehicle and the shadow vehicle with amber colored auxiliary warning lights. The auxiliary warning lights shall be high intensity rotating, flashing, oscillating or strobe lights. Standard vehicle hazard warning lights are only permitted as a supplement to the auxiliary warning lights.

GENERAL NOTES:

1. THIS TRAFFIC CONTROL SETUP IS RESTRICTED TO THOSE TRAFFIC SIGNAL WORK ACTIVITIES CONDUCTED ON TWO-LANE TWO-WAY ROADWAYS THAT REQUIRES THE WORK VEHICLE TO OPERATE IN THE TRAVEL LANE IN ITS ENTIRETY AND DOES NOT EXCEED 15 MINUTES. CONDUCT ALL EQUIPMENT AND MATERIAL PREPARATIONS PRIOR TO ENTERING THE ROADWAY.

IF THE WORK VEHICLE IS ABLE TO OPERATE IN THE SHOULDER AREA, SEE THE REQUIREMENTS FOR INTERMITTENT MOBILE OPERATIONS.

2. WHEN THE WORK VEHICLE OPERATES IN THE TRAVEL LANE IN ITS ENTIRETY, A SINGLE FLAGGER OR A UNIFORMED LAW ENFORCEMENT OFFICER IS REQUIRED TO CONTROL THE TRAFFIC UTILIZING THE OPEN TRAVEL LANE ADJACENT TO THE WORK VEHICLE. THE SINGLE FLAGGER SHOULD STAND ON OR IMMEDIATELY ADJACENT TO THE SHOULDER OF THE OPPOSING TRAVEL LANE TO MAXIMIZE THE SIGHT DISTANCE BETWEEN THE FLAGGER AND THE MOTORIST.

3. WHEN A SINGLE FLAGGER IS PRESENT TO CONTROL THE TRAFFIC, ADVANCE WARNING SIGNS RELATIVE TO A FLAGGING OPERATION ARE NOT REQUIRED FOR THIS TRAFFIC CONTROL SETUP DUE TO THE PROXIMITY OF THE WORK OPERATION TO THE TRAFFIC SIGNAL.

4. WHEN A SINGLE FLAGGER IS PRESENT TO CONTROL THE TRAFFIC, PLACE THE TRAFFIC SIGNAL ON "NORMAL FLASHING OPERATIONS".

5. WHEN A UNIFORMED LAW ENFORCEMENT OFFICER IS PRESENT TO CONTROL THE TRAFFIC, THE TRAFFIC SIGNAL MAY OR MAY NOT BE PLACED ON "NORMAL FLASHING OPERATIONS".

6. A SINGLE FLAGGER OR A UNIFORMED LAW ENFORCEMENT OFFICER IS NOT REQUIRED WHEN THE WORK VEHICLE IS ABLE TO OPERATE WHILE ENCRDACHING UPON THE SHOULDER AREA IN ACCORDANCE WITH THE REQUIREMENTS FOR INTERMITTENT MOBILE OPERATIONS.

DRAWING 605-01-A
TRAFFIC SIGNAL
WORK OPERATIONS
VEHICLE TRAIN
TWO-LANE TWO-WAY ROADWAY
PRIMARY & SECONDARY
ROUTES
TRAFFIC SIGNAL WORK ACTIVITIES
COMPLETED IN
15 MINUTES OR LESS

VEHICLE TRAIN

WORK VEHICLE

AMBER COLORED HIGH INTENSITY ROTATING, FLASHING, OSCILLATING OR STROBE LIGHTS ARE REQUIRED ON THE WORK VEHICLE. VEHICLE HAZARD WARNING LIGHTS ARE ONLY PERMITTED AS A SUPPLEMENT TO THESE DEVICES.

SHADOW VEHICLE (OPTIONAL)

AN AMBER COLORED AUXILIARY WARNING LIGHT MOUNTED ON TOP OF THE SHADOW VEHICLE IS REQUIRED.

A TRUCK MOUNTED ADVANCE WARNING ARROW PANEL OPERATING IN THE "FOUR CORNER" CAUTION MODE DISPLAYING FOUR LAMPS WITH ONE IN EACH CORNER IS OPTIONAL ON THE SHADOW VEHICLE.

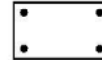

A TRUCK MOUNTED ATTENUATOR IS OPTIONAL ON THE SHADOW VEHICLE.

OPERATE THE SHADOW VEHICLE IN THE SAME TRAVEL LANE AS THE WORK VEHICLE ON THE APPROACH TO THE INTERSECTION WITHOUT ENCRDACHING INTO THE INTERSECTION.

REQUIREMENTS FOR MINIMIZATION OF TRAFFIC IMPACTS

TRAFFIC SIGNAL WORK ACTIVITIES CONDUCTED UNDER THIS TRAFFIC CONTROL SETUP ARE RESTRICTED TO A TIME DURATION NOT TO EXCEED 15 MINUTES. VACATE THE INTERSECTION IN ITS ENTIRETY OF ALL WORK VEHICLES, TRAFFIC CONTROL DEVICES, MATERIAL AND/OR PERSONNEL IMMEDIATELY UPON COMPLETION OF THE TRAFFIC SIGNAL WORK ACTIVITIES. THE INTERSECTION SHALL REMAIN CLEAR OF ALL WORK VEHICLES, TRAFFIC CONTROL DEVICES, MATERIAL AND PERSONNEL FOR NO LESS THAN 15 MINUTES PRIOR TO BEGINNING A SUBSEQUENT TRAFFIC SIGNAL WORK ACTIVITY WITHIN THE LIMITS OF THE SAME INTERSECTION.

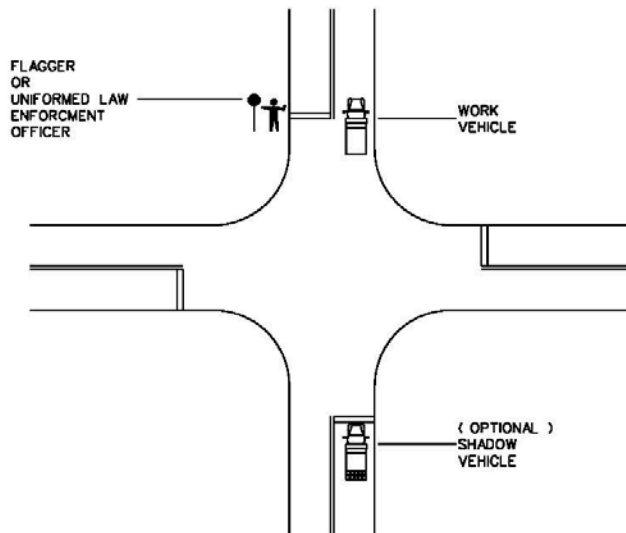

**TRAFFIC SIGNAL
WORK OPERATIONS
VEHICLE TRAIN
TWO-LANE TWO-WAY ROADWAY
PRIMARY & SECONDARY ROUTES
TRAFFIC SIGNAL WORK ACTIVITIES
THAT EXCEED A TIME DURATION OF 15 MINUTES**

1. This traffic control setup is restricted to traffic signal work activities conducted on two-lane two-way roadways that exceed 15 minutes.
This traffic control setup requires installation of multiple flagger flagging operations on all approaches or uniformed law enforcement(s) to control the traffic.
When flaggers are present to control the traffic, place the traffic signal on "normal flashing operations".
When a uniformed law enforcement officer is present to control the traffic, the traffic signal may or may not be placed on "normal flashing operations".
2. Avoid conducting traffic signal work or similar work activities that interfere with or create disruptions to normal traffic operations during high traffic volume peak periods when possible.
3. Install a multiple flagger flagging operation, including all traffic control devices necessary for a flagging operation, in the roadway where the vehicle train is operating. Only the "Flagger" (W20-7-48) symbol sign is required on the side road approaches intersecting the roadway the vehicle train is operating in. Traffic control devices are not required on the intersecting roadway approaches.
4. The vehicle train shall include the primary work vehicle and a shadow vehicle. A secondary work vehicle is optional.
5. A secondary work vehicle is optional in the vehicle train.
A truck mounted advance warning arrow panel operating in the "Four Corner" Caution Mode with one lamp in each corner is optional on the secondary work vehicle.
A truck mounted attenuator is optional on the secondary work vehicle.
Operate the secondary work vehicle in the same travel lane as the primary work vehicle on the approach to the intersection without encroaching into the intersection.
6. A shadow vehicle is required in the vehicle train.
A truck mounted advance warning arrow panel operating in the "Four Corner" Caution Mode with one lamp in each corner is optional on the shadow vehicle.
A truck mounted attenuator is optional on the shadow vehicle.
Operate the shadow vehicle in the same travel lane as the primary work vehicle on the approach to the intersection without encroaching into the intersection. When a secondary work vehicle is utilized, operate the shadow vehicle 25' to 100' in advance of the secondary work vehicle.
7. Supplement all vehicles, including the primary work vehicle, the secondary work vehicle and the shadow vehicle, operating in the vehicle train with amber colored high intensity rotating, flashing, oscillating or strobe lights. Standard vehicle hazard warning lights are only permitted as a supplement to the auxiliary warning lights.
8. Maintain two-way radio communications between all flaggers.

DRAWING 605-01-B
 TRAFFIC SIGNAL
 WORK OPERATIONS
 VEHICLE TRAIN
 TWO-LANE TWO-WAY ROADWAY
 PRIMARY & SECONDARY
 ROUTES

TRAFFIC SIGNAL WORK ACTIVITIES
 THAT EXCEED A TIME DURATION
 OF 15 MINUTES

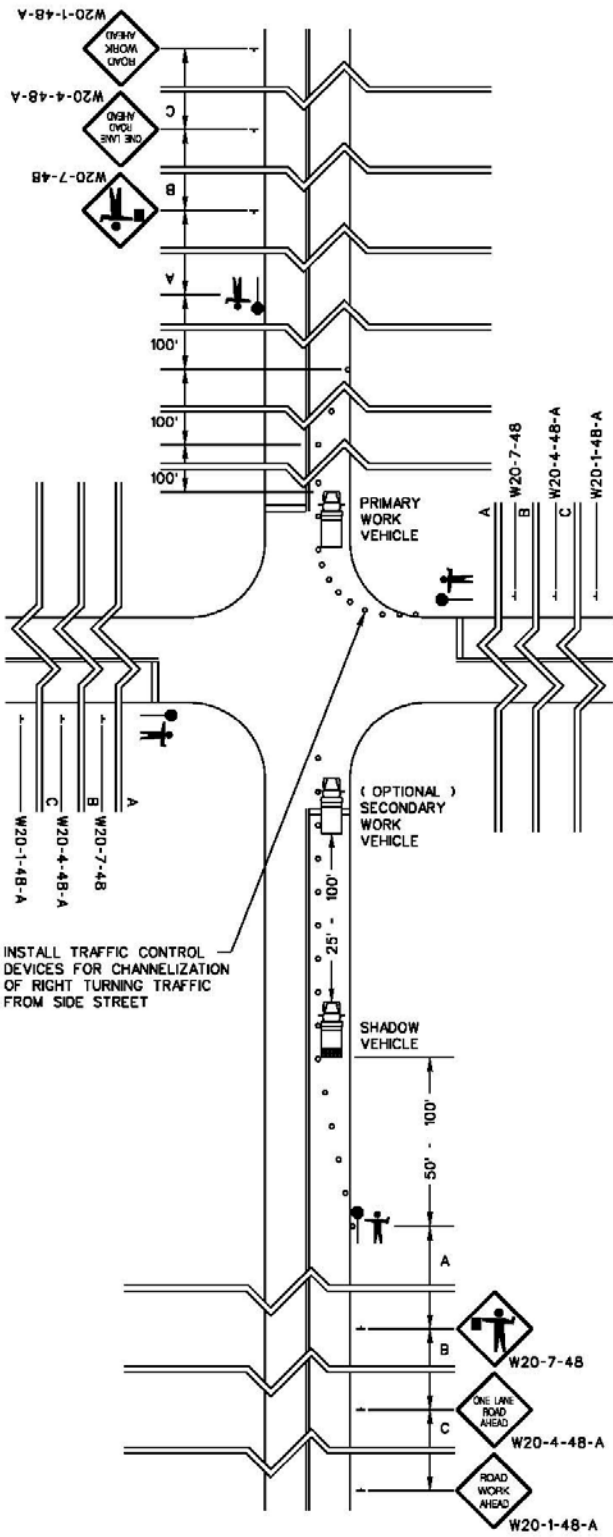

GENERAL NOTES:

1. THIS TRAFFIC CONTROL SETUP APPLIES TO THOSE TRAFFIC SIGNAL WORK ACTIVITIES CONDUCTED ON A TWO-LANE TWO-WAY ROADWAY THAT EXCEED A TIME DURATION OF 15 MINUTES.
2. INSTALL AND CONDUCT FLAGGING OPERATIONS ON ALL APPROACHES TO THE INTERSECTION. ONLY FLAGGERS AND ADVANCE WARNING SIGNS ARE REQUIRED ON THE APPROACHES INTERSECTING THE TRAVEL LANE THE VEHICLE TRAIN IS OPERATING IN. TRAFFIC CONTROL DEVICES ARE NOT REQUIRED ON THE INTERSECTING ROADWAY APPROACHES.
3. MAINTAIN TWO-WAY RADIO COMMUNICATIONS BETWEEN ALL FLAGGERS.

VEHICLE TRAIN

PRIMARY WORK VEHICLE

AMBER COLORED HIGH INTENSITY ROTATING, FLASHING, OSCILLATING OR STROBE LIGHTS ARE REQUIRED ON THE WORK VEHICLE. VEHICLE HAZARD WARNING LIGHTS ARE ONLY PERMITTED AS A SUPPLEMENT TO THESE DEVICES.

SECONDARY WORK VEHICLE

A TRUCK MOUNTED ADVANCE WARNING ARROW PANEL OPERATING IN THE "FOUR CORNER" CAUTION MODE DISPLAYING ONE LAMP IN EACH CORNER IS REQUIRED ON A SECONDARY WORK VEHICLE. 

A TRUCK MOUNTED ATTENUATOR IS OPTIONAL ON A SECONDARY WORK VEHICLE.

OPERATE THE SECONDARY WORK VEHICLE ON THE APPROACH TO THE INTERSECTION WITHOUT ENCRANCHING INTO THE INTERSECTION.

SHADOW VEHICLE

A TRUCK MOUNTED ADVANCE WARNING ARROW PANEL OPERATING IN THE "FOUR CORNER" CAUTION MODE DISPLAYING ONE LAMP IN EACH CORNER IS REQUIRED ON THE SHADOW VEHICLE. 

A TRUCK MOUNTED ATTENUATOR IS OPTIONAL ON A SHADOW VEHICLE IN THIS MULTIPLE FLAGGER FLAGGING OPERATION.

OPERATE THE SHADOW VEHICLE ON THE APPROACH TO THE INTERSECTION WITHOUT ENCRANCHING INTO THE INTERSECTION. WHEN A SECONDARY WORK VEHICLE IS UTILIZED, OPERATE THE SHADOW VEHICLE 25' TO 100' IN ADVANCE OF THE SECONDARY WORK VEHICLE.

ADVANCE WARNING SIGN PLACEMENT INTERVALS			
	A	B	C
URBAN / RURAL (LOW SPEED) ≤ 35 MPH	200 FT	200 FT	200 FT
URBAN / RURAL (INTERMEDIATE SPEED) 40 MPH - 50 MPH	350 FT	350 FT	350 FT
RURAL (HIGH SPEED) ≥ 55 MPH	500 FT	500 FT	500 FT

**TRAFFIC SIGNAL
WORK OPERATIONS
VEHICLE TRAIN
RIGHT LANE CLOSURE
MULTILANE
PRIMARY & SECONDARY ROUTES
TRAFFIC SIGNAL WORK ACTIVITIES
COMPLETED IN 15 MINUTES OR LESS**

1. This traffic control setup is restricted to traffic signal work activities conducted within the right travel lane of a multilane primary or secondary roadway that do not exceed 15 minutes.
2. Avoid conducting traffic signal work or similar work activities that interfere with or create disruptions to normal traffic operations during high traffic volume peak periods when possible.
3. The vehicle train shall include the work vehicle and a shadow vehicle.
4. A shadow vehicle is required in the vehicle train.
A truck mounted advance warning arrow panel displaying a flashing arrow is optional on the shadow vehicle. When a right turn lane is present, operate the truck mounted advance warning arrow panel in the double arrow mode when travel lanes open to traffic are present on each side of the shadow vehicle.
A truck mounted attenuator is optional on the shadow vehicle.
Operate a shadow vehicle in the same travel lane as the work vehicle on the approach to the intersection without encroaching into the intersection.
5. Traffic signal work activities conducted under this traffic control setup are restricted to a duration not to exceed 15 minutes. Vacate the intersection in its entirety of all work vehicles, traffic control devices, material and/or personnel immediately upon reaching the end of the 15 minute time period. The intersection, including up to within 500 feet on each approach to the intersection, shall remain clear of all work vehicles, traffic control devices, material and/or personnel for no less than 15 minutes prior to beginning a subsequent traffic signal work activity within the specified limits of the intersection.
6. Conduct all equipment and material preparations prior to entering the roadway.
7. Supplement the work vehicle and the shadow vehicles with amber colored auxiliary warning lights. The auxiliary warning lights shall be high intensity rotating, flashing, oscillating or strobe lights. Standard vehicle hazard warning lights are only permitted as a supplement to the auxiliary warning lights.

GENERAL NOTES:

1. THIS TRAFFIC CONTROL SETUP IS RESTRICTED TO THOSE TRAFFIC SIGNAL WORK ACTIVITIES CONDUCTED IN THE RIGHT TRAVEL LANE OF A MULTILANE ROADWAY THAT DO NOT EXCEED 15 MINUTES. CONDUCT ALL EQUIPMENT AND MATERIAL PREPARATIONS PRIOR TO ENTERING THE ROADWAY.
2. ON MULTILANE ROADWAYS, THE VEHICLE TRAIN SHALL INCLUDE THE WORK VEHICLE AND A SHADOW VEHICLE.
3. FOR THE TRAFFIC CONTROL SETUP FOR A SIDE STREET WITH DUAL LEFT TURN LANES, SEE DRAWING 605-05-A(1).

VEHICLE TRAIN

WORK VEHICLE

AMBER COLORED HIGH INTENSITY ROTATING, FLASHING, OSCILLATING OR STROBE LIGHTS ARE REQUIRED ON THE WORK VEHICLE. VEHICLE HAZARD WARNING LIGHTS ARE ONLY PERMITTED AS A SUPPLEMENT TO THESE DEVICES.

SHADOW VEHICLE

AMBER COLORED HIGH INTENSITY ROTATING, FLASHING, OSCILLATING OR STROBE LIGHTS ARE REQUIRED ON THE SHADOW VEHICLE. VEHICLE HAZARD WARNING LIGHTS ARE ONLY PERMITTED AS A SUPPLEMENT TO THESE DEVICES.

A TRUCK MOUNTED ADVANCE WARNING ARROW PANEL DISPLAYING A FLASHING ARROW IS OPTIONAL ON THE SHADOW VEHICLE.



WHEN A RIGHT TURN LANE IS PRESENT, OPERATE THE ADVANCE WARNING ARROW PANEL IN THE DOUBLE ARROW MODE WHEN TRAVEL LANES OPEN TO TRAFFIC ARE PRESENT ON EACH SIDE OF THE SHADOW VEHICLE.

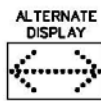

A TRUCK MOUNTED ATTENUATOR IS OPTIONAL ON THE SHADOW VEHICLE.

OPERATE THE SHADOW VEHICLE IN THE SAME TRAVEL LANE AS THE WORK VEHICLE ON THE APPROACH TO THE INTERSECTION WITHOUT ENCRDACHING INTO THE INTERSECTION.

DRAWING 605-02-A
TRAFFIC SIGNAL
WORK OPERATIONS
VEHICLE TRAIN
RIGHT LANE CLOSURE
MULTILANE
PRIMARY & SECONDARY
ROUTES
TRAFFIC SIGNAL WORK ACTIVITIES
COMPLETED IN
15 MINUTES OR LESS

REQUIREMENTS FOR MINIMIZATION OF TRAFFIC IMPACTS

TRAFFIC SIGNAL WORK ACTIVITIES CONDUCTED UNDER THIS TRAFFIC CONTROL SETUP ARE RESTRICTED TO A TIME DURATION NOT TO EXCEED 15 MINUTES. VACATE THE INTERSECTION IN ITS ENTIRETY OF ALL WORK VEHICLES, TRAFFIC CONTROL DEVICES, MATERIAL AND/OR PERSONNEL IMMEDIATELY UPON COMPLETION OF THE TRAFFIC SIGNAL WORK ACTIVITIES. THE INTERSECTION, INCLUDING UP TO WITHIN 500 FEET ON EACH APPROACH TO THE INTERSECTION, SHALL REMAIN CLEAR OF ALL WORK VEHICLES, TRAFFIC CONTROL DEVICES, MATERIAL AND PERSONNEL FOR NO LESS THAN 15 MINUTES PRIOR TO BEGINNING A SUBSEQUENT TRAFFIC SIGNAL WORK ACTIVITY WITHIN THE SPECIFIED LIMITS OF THE INTERSECTION.

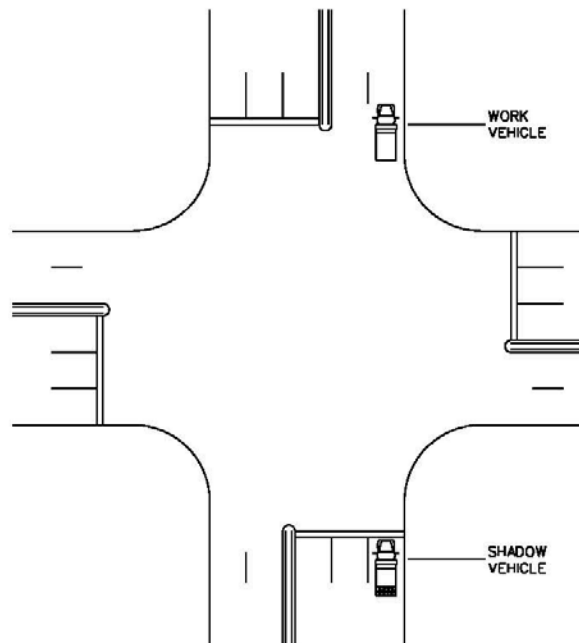

**TRAFFIC SIGNAL
WORK OPERATIONS
VEHICLE TRAIN
RIGHT LANE CLOSURE
MULTILANE
PRIMARY & SECONDARY ROUTES
TRAFFIC SIGNAL WORK ACTIVITIES
THAT EXCEED A TIME DURATION OF 15 MINUTES
BUT NOT MORE THAN 60 MINUTES**

1. This traffic control setup is restricted to traffic signal work activities conducted within the right travel lane of a multilane primary or secondary roadway that exceed a time duration of 15 minutes but not more than 60 minutes.
2. Install a standard lane closure for those traffic signal work activities that require the vehicle train to encroach upon or operate within the limits of a travel lane for longer than 60 minutes.
3. Avoid conducting traffic signal work or similar work activities that interfere with or create disruptions to normal traffic operations during high traffic volume peak periods when possible.
4. The vehicle train shall include the primary work vehicle and a shadow vehicle. A secondary work vehicle is optional.
5. A secondary work vehicle is optional in the vehicle train.
A truck mounted advance warning arrow panel displaying a flashing arrow is optional on the secondary work vehicle. When a right turn lane is present, operate the truck mounted advance warning arrow panel in the double arrow mode when travel lanes open to traffic are present on each side of the secondary work vehicle.
A truck mounted attenuator is optional on the secondary work vehicle.
Operate the secondary work vehicle in the same travel lane as the primary work vehicle on the approach to the intersection without encroaching into the intersection.
6. A shadow vehicle is required in the vehicle train.
A truck mounted advance warning arrow panel displaying a flashing arrow is required on the shadow vehicle. When a right turn lane is present, operate the truck mounted advance warning arrow panel in the double arrow mode when travel lanes open to traffic are present on each side of the shadow vehicle.
A truck mounted attenuator is required on the shadow vehicle.
Operate the shadow vehicle in the same travel lane as the primary work vehicle on the approach to the intersection without encroaching into the intersection. When a secondary work vehicle is used, operate the shadow vehicle 25' to 100' in advance of the secondary work vehicle.
7. Install and maintain traffic control devices in advance of and adjacent to the primary work vehicle to channelize traffic turning from the side street.
8. Supplement the work vehicles and the shadow vehicles with amber colored auxiliary warning lights. The auxiliary warning lights shall be high intensity rotating, flashing, oscillating or strobe lights. Standard vehicle hazard warning lights are only permitted as a supplement to the auxiliary warning lights.

GENERAL NOTES:

1. THIS TRAFFIC CONTROL SETUP IS RESTRICTED TO THOSE TRAFFIC SIGNAL WORK ACTIVITIES CONDUCTED IN THE RIGHT TRAVEL LANE OF A MULTILANE ROADWAY THAT EXCEED A TIME DURATION OF 15 MINUTES BUT NOT MORE THAN 60 MINUTES.
2. INSTALL A STANDARD LANE CLOSURE FOR THOSE TRAFFIC SIGNAL WORK ACTIVITIES THAT REQUIRE THE VEHICLE TRAIN TO REMAIN IN THE ROADWAY FOR LONGER THAN 60 MINUTES.
3. THE VEHICLE TRAIN SHALL INCLUDE THE PRIMARY WORK VEHICLE AND A SHADOW VEHICLE. A SECONDARY WORK VEHICLE IS OPTIONAL.
4. FOR THE TRAFFIC CONTROL SETUP FOR A SIDE STREET WITH DUAL LEFT TURN LANES, SEE DRAWING 605-05-B(1).

**DRAWING 605-02-B
TRAFFIC SIGNAL
WORK OPERATIONS
VEHICLE TRAIN
RIGHT LANE CLOSURE
MULTILANE
PRIMARY & SECONDARY
ROUTES
TRAFFIC SIGNAL WORK ACTIVITIES
THAT EXCEED A TIME DURATION
OF 15 MINUTES
BUT NOT MORE THAN 60 MINUTES**

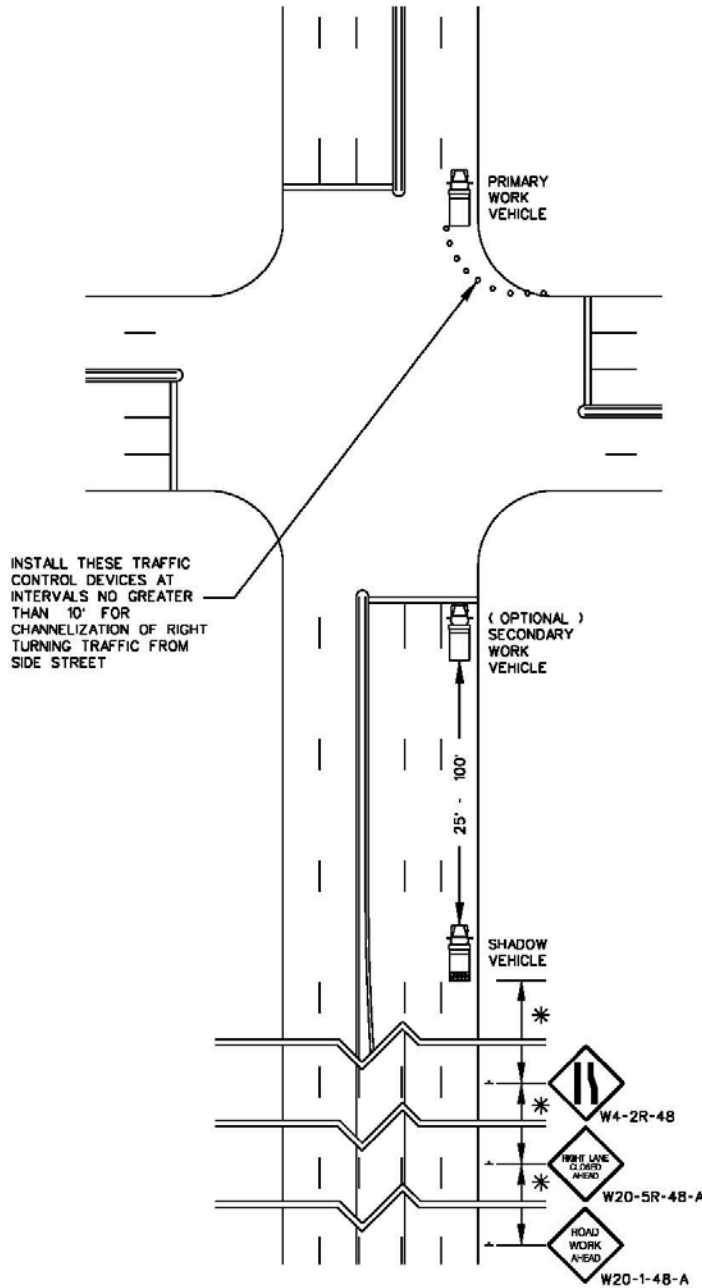

VEHICLE TRAIN

PRIMARY WORK VEHICLE

AMBER COLORED HIGH INTENSITY ROTATING, FLASHING, OSCILLATING OR STROBE LIGHTS ARE REQUIRED ON THE WORK VEHICLE. VEHICLE HAZARD WARNING LIGHTS ARE ONLY PERMITTED AS A SUPPLEMENT TO THESE DEVICES.

SECONDARY WORK VEHICLE (OPTIONAL)

AMBER COLORED HIGH INTENSITY ROTATING, FLASHING, OSCILLATING OR STROBE LIGHTS ARE REQUIRED ON THE SECONDARY WORK VEHICLE. VEHICLE HAZARD WARNING LIGHTS ARE ONLY PERMITTED AS A SUPPLEMENT TO THESE DEVICES.

A TRUCK MOUNTED ADVANCE WARNING ARROW PANEL DISPLAYING A FLASHING ARROW IS OPTIONAL ON THE SECONDARY WORK VEHICLE.

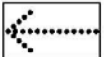

WHEN A RIGHT TURN LANE IS PRESENT, OPERATE THE ADVANCE WARNING ARROW PANEL IN THE DOUBLE ARROW MODE WHEN TRAVEL LANES OPEN TO TRAFFIC ARE PRESENT ON EACH SIDE OF THE SECONDARY WORK VEHICLE.

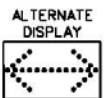

A TRUCK MOUNTED ATTENUATOR IS OPTIONAL ON A SECONDARY WORK VEHICLE.

OPERATE THE SECONDARY WORK VEHICLE IN THE SAME TRAVEL LANE AS THE PRIMARY WORK VEHICLE ON THE APPROACH TO THE INTERSECTION WITHOUT ENCRoACHING INTO THE INTERSECTION

SHADOW VEHICLE

AMBER COLORED HIGH INTENSITY ROTATING, FLASHING, OSCILLATING OR STROBE LIGHTS ARE REQUIRED ON THE SHADOW VEHICLE. VEHICLE HAZARD WARNING LIGHTS ARE ONLY PERMITTED AS A SUPPLEMENT TO THESE DEVICES.

A TRUCK MOUNTED ADVANCE WARNING ARROW PANEL DISPLAYING A FLASHING ARROW IS REQUIRED ON THE SHADOW VEHICLE.



WHEN A RIGHT TURN LANE IS PRESENT, OPERATE THE ADVANCE WARNING ARROW PANEL IN THE DOUBLE ARROW MODE WHEN TRAVEL LANES OPEN TO TRAFFIC ARE PRESENT ON EACH SIDE OF THE SHADOW VEHICLE.

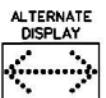

A TRUCK MOUNTED ATTENUATOR IS REQUIRED ON THE SHADOW VEHICLE.

OPERATE THE SHADOW VEHICLE IN THE SAME TRAVEL LANE AS THE PRIMARY WORK VEHICLE ON THE APPROACH TO THE INTERSECTION WITHOUT ENCRoACHING INTO THE INTERSECTION.

ADVANCE WARNING SIGN PLACEMENT INTERVALS

SPEED LIMIT	*	*	*
URBAN / RURAL (LOW SPEED) ≤ 35 MPH	200 FT	200 FT	200 FT
URBAN / RURAL (INTERMEDIATE SPEED) 40 MPH - 50 MPH	350 FT	350 FT	350 FT
RURAL (HIGH SPEED) ≥ 50 MPH	500 FT	500 FT	500 FT

NOTE: THESE SIGN PLACEMENT INTERVALS ARE BASED UPON THE POSTED REGULATORY SPEED LIMIT OF THE ROADWAY PRIOR TO BEGINNING ANY WORK.

**TRAFFIC SIGNAL
WORK OPERATIONS
VEHICLE TRAIN
LEFT LANE CLOSURE
MULTILANE
PRIMARY & SECONDARY ROUTES
w/ 2 THROUGH LANES
TRAFFIC SIGNAL WORK ACTIVITIES
COMPLETED IN 15 MINUTES OR LESS**

1. This traffic control setup is restricted to traffic signal work activities conducted within an interior travel lane of a multilane primary or secondary roadway that do not exceed 15 minutes.
2. Avoid conducting traffic signal work or similar work activities that interfere with or create disruptions to normal traffic operations during high traffic volume peak periods when possible.
3. The vehicle train shall include the work vehicle and a shadow vehicle.
4. A shadow vehicle is required in the vehicle train.
A truck mounted advance warning arrow panel is optional on the shadow vehicle. Operate the truck mounted advance warning arrow panel in the double arrow mode when travel lanes, including left turn lanes, open to traffic are present on each side of the shadow vehicle.
A truck mounted attenuator is optional on the shadow vehicle.
Operate a shadow vehicle in the same travel lane as the work vehicle on the approach to the intersection without encroaching into the intersection.
4. Traffic signal work activities conducted under this traffic control setup are restricted to a duration not to exceed 15 minutes. Vacate the intersection in its entirety of all work vehicles, traffic control devices, material and/or personnel immediately upon completion of the traffic signal work activities. The intersection, including up to within 500 feet on each approach to the intersection, shall remain clear of all work vehicles, traffic control devices, material and/or personnel for no less than 15 minutes prior to beginning a subsequent traffic signal work activity within the specified limits of the intersection.
5. Conduct all equipment and material preparations prior to entering the roadway.
6. Supplement the work vehicle and the shadow vehicle with amber colored auxiliary warning lights. The auxiliary warning lights shall be high intensity rotating, flashing, oscillating or strobe lights. Standard vehicle hazard warning lights are only permitted as a supplement to the auxiliary warning lights.

GENERAL NOTES:

1. THIS TRAFFIC CONTROL SETUP IS RESTRICTED TO THOSE TRAFFIC SIGNAL WORK ACTIVITIES CONDUCTED IN THE RIGHT TRAVEL LANE OF A MULTILANE ROADWAY THAT DO NOT EXCEED 15 MINUTES. CONDUCT ALL EQUIPMENT AND MATERIAL PREPARATIONS PRIOR TO ENTERING THE ROADWAY.
2. ON MULTILANE ROADWAYS, THE VEHICLE TRAIN SHALL INCLUDE THE WORK VEHICLE AND A SHADOW VEHICLE.
3. FOR THE TRAFFIC CONTROL SETUP FOR A SIDE STREET WITH DUAL LEFT TURN LANES, SEE DRAWING 605-05-A(2).

VEHICLE TRAIN

WORK VEHICLE

AMBER COLORED HIGH INTENSITY ROTATING, FLASHING, OSCILLATING OR STROBE LIGHTS ARE REQUIRED ON THE WORK VEHICLE. VEHICLE HAZARD WARNING LIGHTS ARE ONLY PERMITTED AS A SUPPLEMENT TO THESE DEVICES.

SHADOW VEHICLE

AMBER COLORED HIGH INTENSITY ROTATING, FLASHING, OSCILLATING OR STROBE LIGHTS ARE REQUIRED ON THE SHADOW VEHICLE. VEHICLE HAZARD WARNING LIGHTS ARE ONLY PERMITTED AS A SUPPLEMENT TO THESE DEVICES.

A TRUCK MOUNTED ADVANCE WARNING ARROW PANEL DISPLAYING A FLASHING ARROW IS OPTIONAL ON THE SHADOW VEHICLE.



WHEN A LEFT TURN LANE IS PRESENT, OPERATE THE ADVANCE WARNING ARROW PANEL IN THE DOUBLE ARROW MODE WHEN TRAVEL LANES OPEN TO TRAFFIC ARE PRESENT ON EACH SIDE OF THE SHADOW VEHICLE.



A TRUCK MOUNTED ATTENUATOR IS OPTIONAL ON THE SHADOW VEHICLE.

OPERATE THE SHADOW VEHICLE IN THE SAME TRAVEL LANE AS THE WORK VEHICLE ON THE APPROACH TO THE INTERSECTION WITHOUT ENCRDACHING INTO THE INTERSECTION.

DRAWING 605-03-A
TRAFFIC SIGNAL
WORK OPERATIONS
VEHICLE TRAIN
LEFT LANE CLOSURE
MULTILANE
PRIMARY & SECONDARY
ROUTES w/
2 THROUGH LANES
TRAFFIC SIGNAL WORK ACTIVITIES
COMPLETED IN
15 MINUTES OR LESS

REQUIREMENTS FOR MINIMIZATION OF TRAFFIC IMPACTS

TRAFFIC SIGNAL WORK ACTIVITIES CONDUCTED UNDER THIS TRAFFIC CONTROL SETUP ARE RESTRICTED TO A TIME DURATION NOT TO EXCEED 15 MINUTES. VACATE THE INTERSECTION IN ITS ENTIRETY OF ALL WORK VEHICLES, TRAFFIC CONTROL DEVICES, MATERIAL AND/OR PERSONNEL IMMEDIATELY UPON COMPLETION OF THE TRAFFIC SIGNAL WORK ACTIVITIES. THE INTERSECTION, INCLUDING UP TO WITHIN 500 FEET ON EACH APPROACH TO THE INTERSECTION, SHALL REMAIN CLEAR OF ALL WORK VEHICLES, TRAFFIC CONTROL DEVICES, MATERIAL AND PERSONNEL FOR NO LESS THAN 15 MINUTES PRIOR TO BEGINNING A SUBSEQUENT TRAFFIC SIGNAL WORK ACTIVITY WITHIN THE SPECIFIED LIMITS OF THE INTERSECTION.

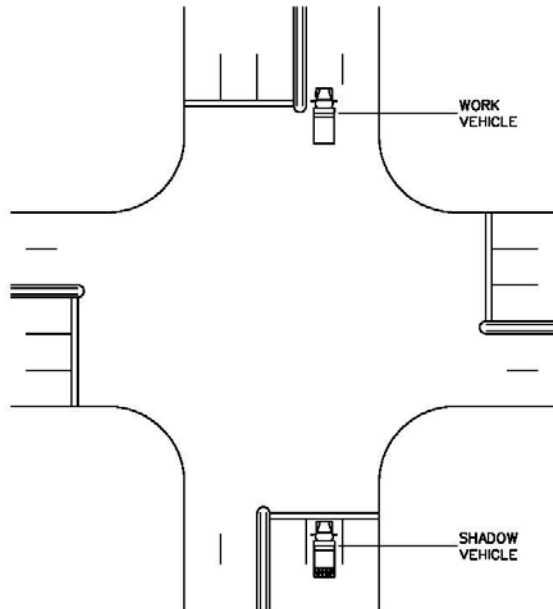

**TRAFFIC SIGNAL
WORK OPERATIONS
VEHICLE TRAIN
LEFT LANE CLOSURE
MULTILANE
PRIMARY & SECONDARY ROUTES
w/ 2 THROUGH LANES
TRAFFIC SIGNAL WORK ACTIVITIES
THAT EXCEED A TIME DURATION OF 15 MINUTES
BUT NOT MORE THAN 60 MINUTES**

1. This traffic control setup is restricted to traffic signal work activities conducted within an interior travel lane of a multilane primary or secondary roadway that exceed a time duration of 15 minutes but not more than 60 minutes.
2. Install a standard lane closure for those traffic signal work activities that require the vehicle train to encroach upon or operate within the limits of a travel lane for a duration greater than 60 minutes.
3. Avoid conducting traffic signal work or similar work activities that interfere with or create disruptions to normal traffic operations during high traffic volume peak periods when possible.
4. The vehicle train shall include the primary work vehicle and a shadow vehicle. A secondary work vehicle is optional.
5. A secondary work vehicle is optional in the vehicle train.
A truck mounted advance warning arrow panel is optional on the secondary work vehicle. Operate the arrow panel in the double arrow mode when travel lanes, including left turn lanes, open to traffic are present on each side of the secondary work vehicle.
A truck mounted attenuator is optional on the secondary work vehicle.
Operate the secondary work vehicle in the same travel lane as the primary work vehicle on the approach to the intersection without encroaching into the intersection.
6. A shadow vehicle is required in the vehicle train.
A truck mounted advance warning arrow panel is required on the shadow vehicle. Operate the arrow panel in the double arrow mode when travel lanes, including left turn lanes, open to traffic are present on each side of the shadow vehicle.
A truck mounted attenuator is required on the shadow vehicle.
Operate the shadow vehicle in the same travel lane as the primary work vehicle on the approach to the intersection without encroaching into the intersection. When a secondary work vehicle is used, operate the shadow vehicle 25' to 100' in advance of the secondary work vehicle.
7. Install and maintain traffic control devices in advance of and adjacent to the primary work vehicle to channelize traffic turning from the side street.
8. Supplement the work vehicles and the shadow vehicles with amber colored auxiliary warning lights. The auxiliary warning lights shall be high intensity rotating, flashing, oscillating or strobe lights. Standard vehicle hazard warning lights are only permitted as a supplement to the auxiliary warning lights.

GENERAL NOTES:

1. THIS TRAFFIC CONTROL SETUP IS RESTRICTED TO THOSE TRAFFIC SIGNAL WORK ACTIVITIES CONDUCTED IN AN INTERIOR TRAVEL LANE OF A MULTILANE ROADWAY THAT EXCEED A TIME DURATION OF 15 MINUTES BUT NOT MORE THAN 60 MINUTES.
2. INSTALL A STANDARD LANE CLOSURE FOR THOSE TRAFFIC SIGNAL WORK ACTIVITIES THAT REQUIRE THE VEHICLE TRAIN TO REMAIN IN THE ROADWAY FOR LONGER THAN 60 MINUTES.
3. THE VEHICLE TRAIN SHALL INCLUDE THE PRIMARY WORK VEHICLE AND A SHADOW VEHICLE. A SECONDARY WORK VEHICLE IS OPTIONAL.
4. FOR THE TRAFFIC CONTROL SETUP FOR A SIDE STREET WITH DUAL LEFT TURN LANES, SEE DRAWING 605-05-B(2).

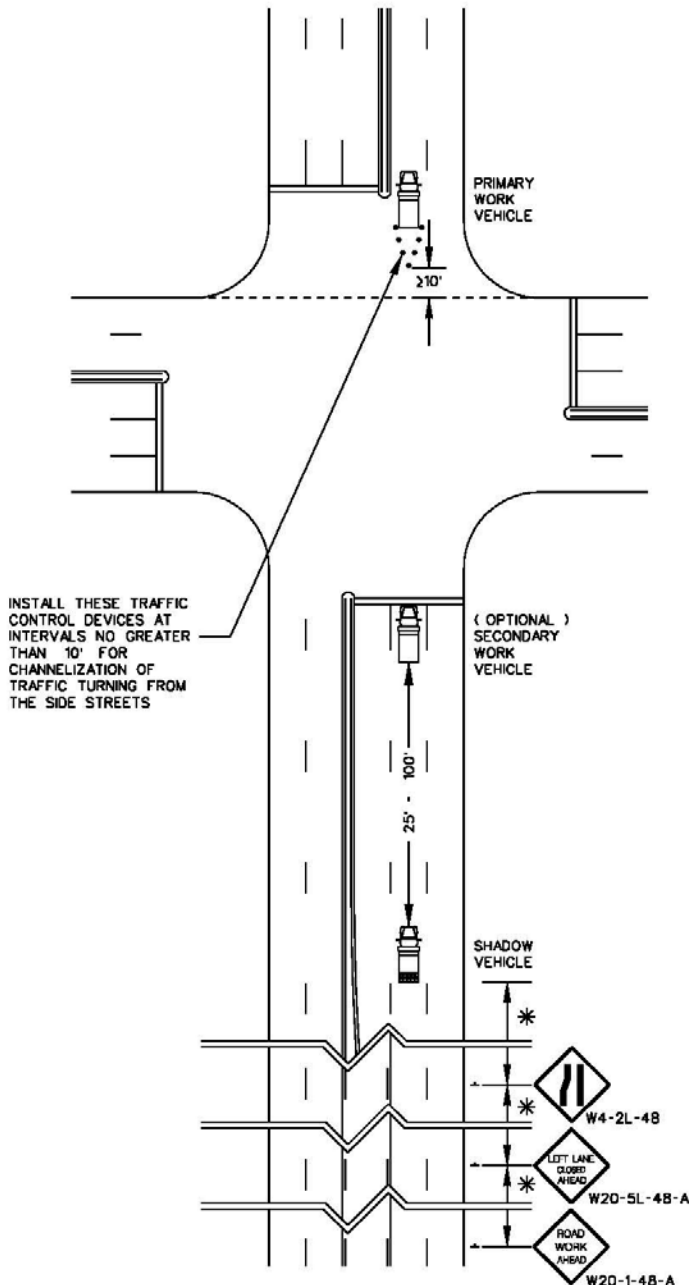

DRAWING 605-03-B
 TRAFFIC SIGNAL
 WORK OPERATIONS
 VEHICLE TRAIN
 LEFT LANE CLOSURE
 MULTILANE
 PRIMARY & SECONDARY
 ROUTES w/
 2 THROUGH LANES
 TRAFFIC SIGNAL WORK ACTIVITIES
 THAT EXCEED A TIME DURATION
 OF 15 MINUTES
 BUT NOT MORE THAN 60 MINUTES

VEHICLE TRAIN

PRIMARY WORK VEHICLE

AMBER COLORED HIGH INTENSITY ROTATING, FLASHING, OSCILLATING OR STROBE LIGHTS ARE REQUIRED ON THE PRIMARY WORK VEHICLE. VEHICLE HAZARD WARNING LIGHTS ARE ONLY PERMITTED AS A SUPPLEMENT TO THESE DEVICES.

SECONDARY WORK VEHICLE (OPTIONAL)

AMBER COLORED HIGH INTENSITY ROTATING, FLASHING, OSCILLATING OR STROBE LIGHTS ARE REQUIRED ON THE SECONDARY WORK VEHICLE. VEHICLE HAZARD WARNING LIGHTS ARE ONLY PERMITTED AS A SUPPLEMENT TO THESE DEVICES.

A TRUCK MOUNTED ADVANCE WARNING ARROW PANEL IS OPTIONAL ON THE SECONDARY WORK VEHICLE.

WHEN A LEFT TURN LANE IS PRESENT, OPERATE THE ADVANCE WARNING ARROW PANEL IN THE DOUBLE ARROW MODE WHEN TRAVEL LANES OPEN TO TRAFFIC ARE PRESENT ON EACH SIDE OF THE SECONDARY WORK VEHICLE.



ALTERNATE DISPLAY

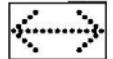

A TRUCK MOUNTED ATTENUATOR IS OPTIONAL ON THE SECONDARY WORK VEHICLE.

OPERATE THE SECONDARY WORK VEHICLE IN THE SAME TRAVEL LANE AS THE PRIMARY WORK VEHICLE ON THE APPROACH TO THE INTERSECTION WITHOUT ENCRDACHING INTO THE INTERSECTION.

SHADOW VEHICLE

AMBER COLORED HIGH INTENSITY ROTATING, FLASHING, OSCILLATING OR STROBE LIGHTS ARE REQUIRED ON THE SHADOW VEHICLE. VEHICLE HAZARD WARNING LIGHTS ARE ONLY PERMITTED AS A SUPPLEMENT TO THESE DEVICES.

A TRUCK MOUNTED ADVANCE WARNING ARROW PANEL IS REQUIRED ON THE SHADOW VEHICLE.

WHEN A LEFT TURN LANE IS PRESENT, OPERATE THE ADVANCE WARNING ARROW PANEL IN THE DOUBLE ARROW MODE WHEN TRAVEL LANES OPEN TO TRAFFIC ARE PRESENT ON EACH SIDE OF THE SHADOW VEHICLE.

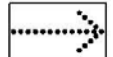

ALTERNATE DISPLAY

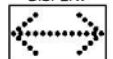

A TRUCK MOUNTED ATTENUATOR IS REQUIRED ON THE SHADOW VEHICLE.

OPERATE THE SHADOW VEHICLE IN THE SAME TRAVEL LANE AS THE PRIMARY WORK VEHICLE ON THE APPROACH TO THE INTERSECTION WITHOUT ENCRDACHING INTO THE INTERSECTION.

ADVANCE WARNING SIGN PLACEMENT INTERVALS			
SPEED LIMIT	*	*	*
URBAN / RURAL (LOW SPEED) ≤ 35 MPH	200 FT	200 FT	200 FT
URBAN / RURAL (INTERMEDIATE SPEED) 40 MPH - 50 MPH	350 FT	350 FT	350 FT
RURAL (HIGH SPEED) ≥ 50 MPH	500 FT	500 FT	500 FT

NOTE: THESE SIGN PLACEMENT INTERVALS ARE BASED UPON THE POSTED REGULATORY SPEED LIMIT OF THE ROADWAY PRIOR TO BEGINNING ANY WORK.

**TRAFFIC SIGNAL
WORK OPERATIONS
VEHICLE TRAIN
INTERIOR LANE CLOSURE
MULTILANE
PRIMARY & SECONDARY ROUTES
w/ 3 OR MORE THROUGH LANES
TRAFFIC SIGNAL WORK ACTIVITIES
COMPLETED IN 15 MINUTES OR LESS**

1. This traffic control setup is restricted to traffic signal work activities conducted within an interior travel lane of a multilane primary or secondary roadway that do not exceed 15 minutes.
2. Avoid conducting traffic signal work or similar work activities that interfere with or create disruptions to normal traffic operations during high traffic volume peak periods when possible.
3. The vehicle train shall include the work vehicle and a shadow vehicle.
4. A shadow vehicle is required in the vehicle train.
A truck mounted advance warning arrow panel is optional on the shadow vehicle. Operate the truck mounted advance warning arrow panel in the double arrow mode when travel lanes, including right and/or left turn lanes, open to traffic are present on each side of the shadow vehicle.
A truck mounted attenuator is optional on the shadow vehicle.
Operate a shadow vehicle in the same travel lane as the work vehicle on the approach to the intersection without encroaching into the intersection.
5. Traffic signal work activities conducted under this traffic control setup are restricted to a duration not to exceed 15 minutes. Vacate the intersection in its entirety of all work vehicles, traffic control devices, material and/or personnel immediately upon completion of the traffic signal work activities. The intersection, including up to within 500 feet on each approach to the intersection, shall remain clear of all work vehicles, traffic control devices, material and/or personnel for no less than 15 minutes prior to beginning a subsequent traffic signal work activity within the specified limits of the intersection.
6. Conduct all equipment and material preparations prior to entering the roadway.
7. Supplement the work vehicle and the shadow vehicle with amber colored auxiliary warning lights. The auxiliary warning lights shall be high intensity rotating, flashing, oscillating or strobe lights. Standard vehicle hazard warning lights are only permitted as a supplement to the auxiliary warning lights.

GENERAL NOTES:

1. THIS TRAFFIC CONTROL SETUP IS RESTRICTED TO THOSE TRAFFIC SIGNAL WORK ACTIVITIES CONDUCTED IN THE RIGHT TRAVEL LANE OF A MULTILANE ROADWAY THAT DO NOT EXCEED 15 MINUTES. CONDUCT ALL EQUIPMENT AND MATERIAL PREPARATIONS PRIOR TO ENTERING THE ROADWAY.
2. ON MULTILANE ROADWAYS, THE VEHICLE TRAIN SHALL INCLUDE THE WORK VEHICLE AND A SHADOW VEHICLE.
3. FOR THE TRAFFIC CONTROL SETUP FOR A SIDE STREET WITH DUAL LEFT TURN LANES, SEE DRAWING 605-05-A(2).

VEHICLE TRAIN

WORK VEHICLE

AMBER COLORED HIGH INTENSITY ROTATING, FLASHING, OSCILLATING OR STROBE LIGHTS ARE REQUIRED ON THE WORK VEHICLE. VEHICLE HAZARD WARNING LIGHTS ARE ONLY PERMITTED AS A SUPPLEMENT TO THESE DEVICES.

SHADOW VEHICLE

AMBER COLORED HIGH INTENSITY ROTATING, FLASHING, OSCILLATING OR STROBE LIGHTS ARE REQUIRED ON THE SHADOW VEHICLE. VEHICLE HAZARD WARNING LIGHTS ARE ONLY PERMITTED AS A SUPPLEMENT TO THESE DEVICES.

A TRUCK MOUNTED ADVANCE WARNING ARROW PANEL DISPLAYING A FLASHING ARROW IS OPTIONAL ON THE SHADOW VEHICLE.

OPERATE THE ADVANCE WARNING ARROW PANEL IN THE DOUBLE ARROW MODE WHEN TRAVEL LANES, INCLUDING RIGHT AND/OR LEFT TURN LANES, OPEN TO TRAFFIC ARE PRESENT ON EACH SIDE OF THE SHADOW VEHICLE.

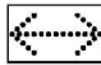

A TRUCK MOUNTED ATTENUATOR IS OPTIONAL ON THE SHADOW VEHICLE.

OPERATE THE SHADOW VEHICLE IN THE SAME TRAVEL LANE AS THE WORK VEHICLE ON THE APPROACH TO THE INTERSECTION WITHOUT ENCRDACHING INTO THE INTERSECTION.

DRAWING 605-04-A
TRAFFIC SIGNAL
WORK OPERATIONS
VEHICLE TRAIN
INTERIOR LANE CLOSURE
MULTILANE
PRIMARY & SECONDARY
ROUTES w/
3 OR MORE THROUGH LANES
TRAFFIC SIGNAL WORK ACTIVITIES
COMPLETED IN
15 MINUTES OR LESS

REQUIREMENTS FOR MINIMIZATION OF TRAFFIC IMPACTS

TRAFFIC SIGNAL WORK ACTIVITIES CONDUCTED UNDER THIS TRAFFIC CONTROL SETUP ARE RESTRICTED TO A TIME DURATION NOT TO EXCEED 15 MINUTES. VACATE THE INTERSECTION IN ITS ENTIRETY OF ALL WORK VEHICLES, TRAFFIC CONTROL DEVICES, MATERIAL AND/OR PERSONNEL IMMEDIATELY UPON COMPLETION OF THE TRAFFIC SIGNAL WORK ACTIVITIES. THE INTERSECTION, INCLUDING UP TO WITHIN 500 FEET ON EACH APPROACH TO THE INTERSECTION, SHALL REMAIN CLEAR OF ALL WORK VEHICLES, TRAFFIC CONTROL DEVICES, MATERIAL AND PERSONNEL FOR NO LESS THAN 15 MINUTES PRIOR TO BEGINNING A SUBSEQUENT TRAFFIC SIGNAL WORK ACTIVITY WITHIN THE SPECIFIED LIMITS OF THE INTERSECTION.

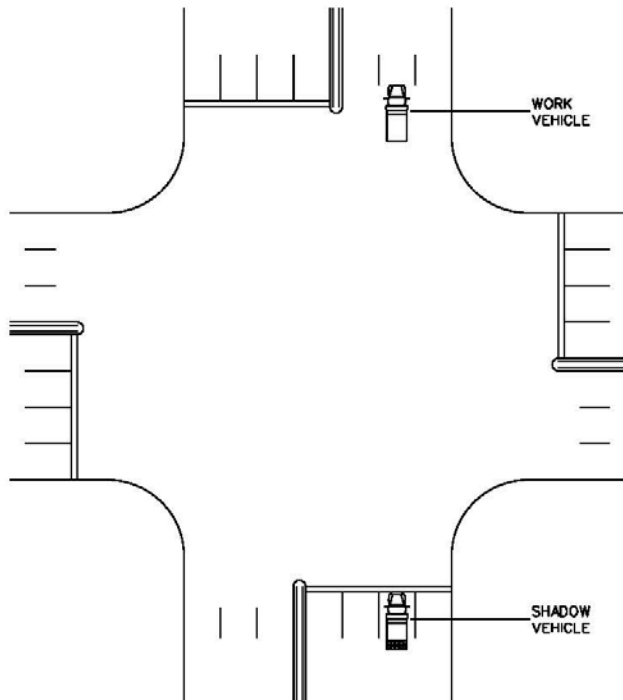

**TRAFFIC SIGNAL
WORK OPERATIONS
VEHICLE TRAIN
INTERIOR LANE CLOSURE
MULTILANE
PRIMARY & SECONDARY ROUTES
w/ 3 OR MORE THROUGH LANES
TRAFFIC SIGNAL WORK ACTIVITIES
THAT EXCEED A TIME DURATION OF 15 MINUTES
BUT NOT MORE THAN 60 MINUTES**

1. This traffic control setup is restricted to traffic signal work activities conducted within an interior travel lane of a multilane primary or secondary roadway that exceed a time duration of 15 minutes but not more than 60 minutes.
2. Install a standard lane closure for those traffic signal work activities that require the vehicle train to encroach upon or operate within the limits of a travel lane for a duration greater than 60 minutes.
3. Avoid conducting traffic signal work or similar work activities that interfere with or create disruptions to normal traffic operations during high traffic volume peak periods when possible.
4. The vehicle train shall include the primary work vehicle and a shadow vehicle. A secondary work vehicle is optional.
5. A secondary work vehicle is optional in the vehicle train.
A truck mounted advance warning arrow panel is optional on the secondary work vehicle. Operate the arrow panel in the double arrow mode when travel lanes, including right and/or left turn lanes, open to traffic are present on each side of the secondary work vehicle.
A truck mounted attenuator is optional on the secondary work vehicle.
Operate the secondary work vehicle in the same travel lane as the primary work vehicle on the approach to the intersection without encroaching into the intersection.
6. A shadow vehicle is required in the vehicle train.
A truck mounted advance warning arrow panel is required on the shadow vehicle. Operate the arrow panel in the double arrow mode when travel lanes, including right and/or left turn lanes, open to traffic are present on each side of the shadow vehicle.
A truck mounted attenuator is required on the shadow vehicle.
Operate the shadow vehicle in the same travel lane as the primary work vehicle on the approach to the intersection without encroaching into the intersection. When a secondary work vehicle is used, operate the shadow vehicle 25' to 100' in advance of the secondary work vehicle.
7. Install and maintain traffic control devices in advance of and adjacent to the primary work vehicle to channelize traffic turning from the side street.
8. Supplement the work vehicles and the shadow vehicles with amber colored auxiliary warning lights. The auxiliary warning lights shall be high intensity rotating, flashing, oscillating or strobe lights. Standard vehicle hazard warning lights are only permitted as a supplement to the auxiliary warning lights.

GENERAL NOTES:

1. THIS TRAFFIC CONTROL SETUP IS RESTRICTED TO THOSE TRAFFIC SIGNAL WORK ACTIVITIES CONDUCTED IN AN INTERIOR TRAVEL LANE OF A MULTILANE ROADWAY THAT EXCEED A TIME DURATION OF 15 MINUTES BUT NOT MORE THAN 60 MINUTES.
2. INSTALL A STANDARD LANE CLOSURE FOR THOSE TRAFFIC SIGNAL WORK ACTIVITIES THAT REQUIRE THE VEHICLE TRAIN TO REMAIN IN THE ROADWAY FOR LONGER THAN 60 MINUTES.
3. THE VEHICLE TRAIN SHALL INCLUDE THE PRIMARY WORK VEHICLE AND A SHADOW VEHICLE. A SECONDARY WORK VEHICLE IS OPTIONAL.
4. FOR THE TRAFFIC CONTROL SETUP FOR A SIDE STREET WITH DUAL LEFT TURN LANES, SEE DRAWING 605-05-B(2).

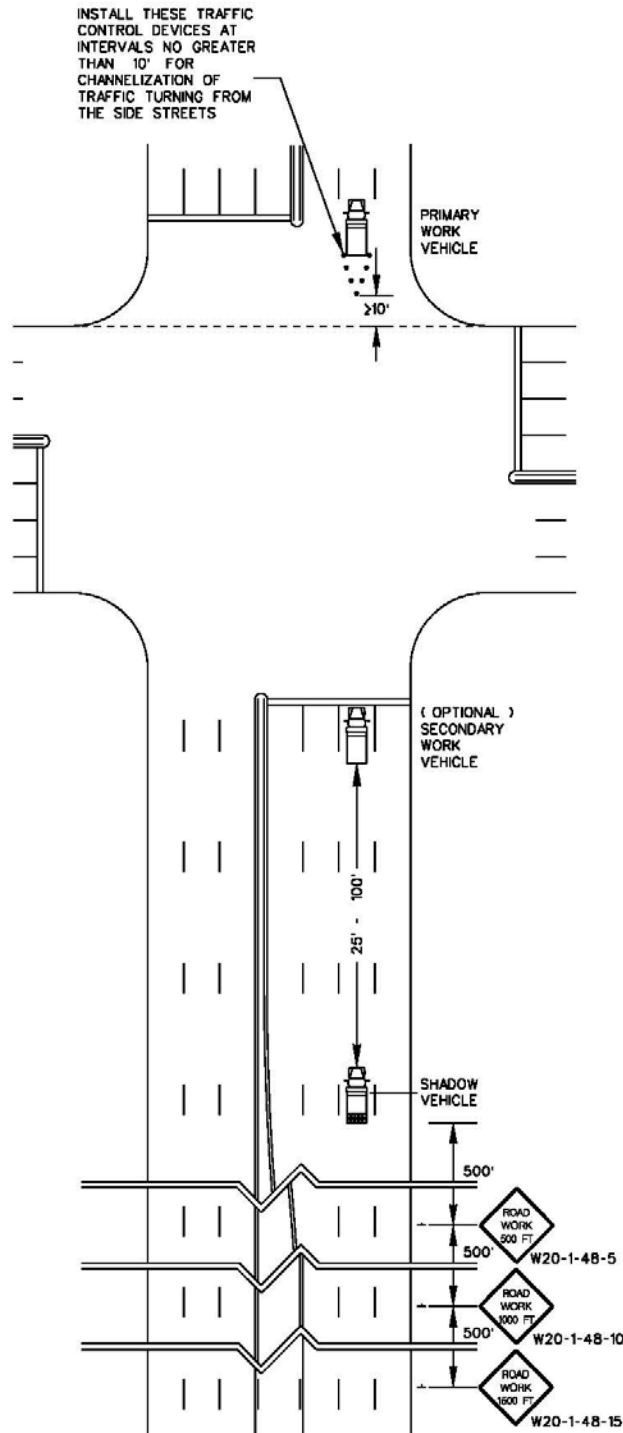

DRAWING 605-04-B
 TRAFFIC SIGNAL
 WORK OPERATIONS
 VEHICLE TRAIN
 INTERIOR LANE CLOSURE
 MULTILANE
 PRIMARY & SECONDARY
 ROUTES w/
 3 OR MORE THROUGH LANES
 TRAFFIC SIGNAL WORK ACTIVITIES
 THAT EXCEED A TIME DURATION
 OF 15 MINUTES
 BUT NOT MORE THAN 60 MINUTES

VEHICLE TRAIN

PRIMARY WORK VEHICLE

AMBER COLORED HIGH INTENSITY ROTATING, FLASHING, OSCILLATING OR STROBE LIGHTS ARE REQUIRED ON THE WORK VEHICLE. VEHICLE HAZARD WARNING LIGHTS ARE ONLY PERMITTED AS A SUPPLEMENT TO THESE DEVICES.

SECONDARY WORK VEHICLE (OPTIONAL)

AMBER COLORED HIGH INTENSITY ROTATING, FLASHING, OSCILLATING OR STROBE LIGHTS ARE REQUIRED ON THE SECONDARY WORK VEHICLE. VEHICLE HAZARD WARNING LIGHTS ARE ONLY PERMITTED AS A SUPPLEMENT TO THESE DEVICES.

A TRUCK MOUNTED ADVANCE WARNING ARROW PANEL DISPLAYING A FLASHING ARROW IS OPTIONAL ON THE SECONDARY WORK VEHICLE.

OPERATE THE ADVANCE WARNING ARROW PANEL IN THE DOUBLE ARROW MODE WHEN TRAVEL LANES, INCLUDING RIGHT AND/OR LEFT TURN LANES, OPEN TO TRAFFIC ARE PRESENT ON EACH SIDE OF THE SECONDARY WORK VEHICLE.



A TRUCK MOUNTED ATTENUATOR IS OPTIONAL ON A SECONDARY WORK VEHICLE.

OPERATE THE SECONDARY WORK VEHICLE IN THE SAME TRAVEL LANE AS THE PRIMARY WORK VEHICLE ON THE APPROACH TO THE INTERSECTION WITHOUT ENCRUCHING INTO THE INTERSECTION

SHADOW VEHICLE

AMBER COLORED HIGH INTENSITY ROTATING, FLASHING, OSCILLATING OR STROBE LIGHTS ARE REQUIRED ON THE SHADOW VEHICLE. VEHICLE HAZARD WARNING LIGHTS ARE ONLY PERMITTED AS A SUPPLEMENT TO THESE DEVICES.

A TRUCK MOUNTED ADVANCE WARNING ARROW PANEL DISPLAYING A FLASHING ARROW IS REQUIRED ON THE SHADOW VEHICLE.

OPERATE THE ADVANCE WARNING ARROW PANEL IN THE DOUBLE ARROW MODE WHEN TRAVEL LANES, INCLUDING RIGHT AND/OR LEFT TURN LANES, OPEN TO TRAFFIC ARE PRESENT ON EACH SIDE OF THE SHADOW VEHICLE.

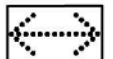

A TRUCK MOUNTED ATTENUATOR IS REQUIRED ON THE SHADOW VEHICLE.

OPERATE THE SHADOW VEHICLE IN THE SAME TRAVEL LANE AS THE PRIMARY WORK VEHICLE ON THE APPROACH TO THE INTERSECTION WITHOUT ENCRUCHING INTO THE INTERSECTION.

**TRAFFIC SIGNAL
WORK OPERATIONS
SIDE STREET TREATMENT
DUAL LEFT TURN LANES
WORK VEHICLE - RIGHT LANE
MULTILANE
PRIMARY & SECONDARY ROUTES
TRAFFIC SIGNAL WORK ACTIVITIES
COMPLETED IN 15 MINUTES OR LESS**

1. This traffic control setup addresses the traffic control for the side street with dual left turn lanes when traffic signal work activities are conducted within the right travel lane of a multilane primary or secondary roadway that do not exceed 15 minutes.
2. Avoid conducting traffic signal work or similar work activities that interfere with or create disruptions to normal traffic operations during high traffic volume peak periods when possible.
3. The vehicle train operating on the side street shall include the side street shadow vehicle.
A truck mounted advance warning arrow panel displaying a flashing arrow is required on the side street shadow vehicle.
A truck mounted attenuator is optional on the side street shadow vehicle.
4. Operate the side street shadow vehicle in the left lane of the dual left turn lanes on the approach to the intersection without encroaching into the intersection. Do not operate the side street shadow vehicle in the right lane of the dual left turn lanes.
5. Traffic signal work activities conducted under this traffic control setup are restricted to a duration not to exceed 15 minutes. Vacate the intersection in its entirety of all work vehicles, traffic control devices, material and/or personnel immediately upon reaching the end of the 15 minute time period. The intersection, including up to within 500 feet on each approach to the intersection, shall remain clear of all work vehicles, traffic control devices, material and/or personnel for no less than 15 minutes prior to beginning a subsequent traffic signal work activity within the specified limits of the intersection.
6. Conduct all equipment and material preparations prior to entering the roadway.
7. Supplement the side street shadow vehicle with amber colored auxiliary warning lights. The auxiliary warning lights shall be high intensity rotating, flashing, oscillating or strobe lights. Standard vehicle hazard warning lights are only permitted as a supplement to the auxiliary warning lights.

GENERAL NOTES:

1. THIS TRAFFIC CONTROL SETUP IS RESTRICTED TO THOSE TRAFFIC SIGNAL WORK ACTIVITIES CONDUCTED IN THE RIGHT TRAVEL LANE OF A MULTILANE ROADWAY THAT DO NOT EXCEED 15 MINUTES. CONDUCT ALL EQUIPMENT AND MATERIAL PREPARATIONS PRIOR TO ENTERING THE ROADWAY.
2. OPERATE THE SIDE STREET SHADOW VEHICLE IN THE LEFT LANE OF THE DUAL LEFT TURN LANES. DO NOT OPERATE THE SIDE STREET SHADOW VEHICLE IN THE RIGHT LANE OF THE DUAL LEFT TURN LANES.

DRAWING 605-05-A(1)
 TRAFFIC SIGNAL
 WORK OPERATIONS
 SIDE STREET TREATMENT
 DUAL LEFT TURN LANES
 WORK VEHICLE - RIGHT LANE
 MULTILANE
 PRIMARY & SECONDARY
 ROUTES
 TRAFFIC SIGNAL WORK ACTIVITIES
 COMPLETED IN
 15 MINUTES OR LESS

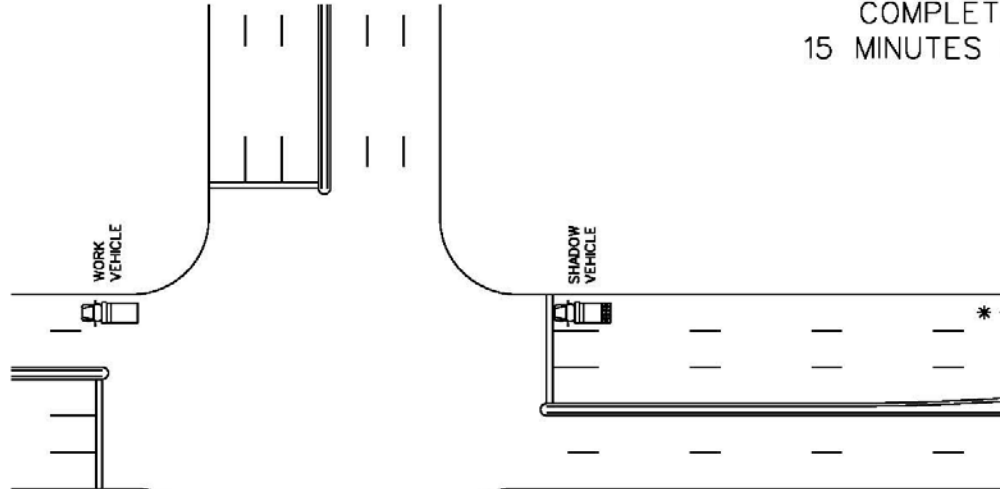

* - SEE DRAWING 605-02-A FOR THIS APPROACH

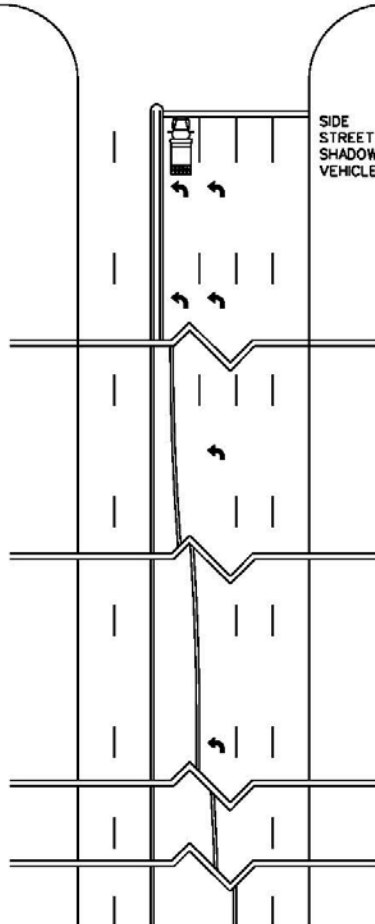

VEHICLE TRAIN

WORK VEHICLE

AMBER COLORED HIGH INTENSITY ROTATING, FLASHING, OSCILLATING OR STROBE LIGHTS ARE REQUIRED ON THE WORK VEHICLE. VEHICLE HAZARD WARNING LIGHTS ARE ONLY PERMITTED AS A SUPPLEMENT TO THESE DEVICES.

SHADOW VEHICLE

AMBER COLORED HIGH INTENSITY ROTATING, FLASHING, OSCILLATING OR STROBE LIGHTS ARE REQUIRED ON THE SHADOW VEHICLE. VEHICLE HAZARD WARNING LIGHTS ARE ONLY PERMITTED AS A SUPPLEMENT TO THESE DEVICES.

A TRUCK MOUNTED ADVANCE WARNING ARROW PANEL DISPLAYING A FLASHING ARROW IS OPTIONAL ON THE SHADOW VEHICLE.

WHEN A RIGHT TURN LANE IS PRESENT, OPERATE THE ADVANCE WARNING ARROW PANEL IN THE DOUBLE ARROW MODE WHEN TRAVEL LANES OPEN TO TRAFFIC ARE PRESENT ON EACH SIDE OF THE SHADOW VEHICLE.

A TRUCK MOUNTED ATTENUATOR IS OPTIONAL ON THE SHADOW VEHICLE.

OPERATE THE SHADOW VEHICLE IN THE SAME TRAVEL LANE AS THE WORK VEHICLE ON THE APPROACH TO THE INTERSECTION WITHOUT ENCROACHING INTO THE INTERSECTION.

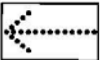

ALTERNATE DISPLAY

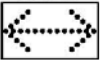

SIDE STREET SHADOW VEHICLE

AMBER COLORED HIGH INTENSITY ROTATING, FLASHING, OSCILLATING OR STROBE LIGHTS ARE REQUIRED ON THE SIDE STREET SHADOW VEHICLE. VEHICLE HAZARD WARNING LIGHTS ARE ONLY PERMITTED AS A SUPPLEMENT TO THESE DEVICES.

A TRUCK MOUNTED ADVANCE WARNING ARROW PANEL DISPLAYING A FLASHING ARROW IS REQUIRED ON THE SIDE STREET SHADOW VEHICLE.

A TRUCK MOUNTED ATTENUATOR IS OPTIONAL ON THE SIDE STREET SHADOW VEHICLE.

OPERATE THE SIDE STREET SHADOW VEHICLE IN THE LEFT LANE OF THE DUAL LEFT TURN LANES. DO NOT OPERATE THE SIDE STREET SHADOW VEHICLE IN THE RIGHT LANE OF THE DUAL LEFT TURN LANES.



**TRAFFIC SIGNAL
WORK OPERATIONS
SIDE STREET TREATMENT
DUAL LEFT TURN LANES
WORK VEHICLE - LEFT LANE
MULTILANE
PRIMARY & SECONDARY ROUTES
TRAFFIC SIGNAL WORK ACTIVITIES
COMPLETED IN 15 MINUTES OR LESS**

1. This traffic control setup addresses the traffic control for the side street with dual left turn lanes when traffic signal work activities are conducted within the left travel lane of a multilane primary or secondary roadway that do not exceed 15 minutes.
2. Avoid conducting traffic signal work or similar work activities that interfere with or create disruptions to normal traffic operations during high traffic volume peak periods when possible.
3. The vehicle train operating on the side street shall include the side street shadow vehicle.
A truck mounted advance warning arrow panel displaying a flashing arrow is required on the side street shadow vehicle.
A truck mounted attenuator is optional on the side street shadow vehicle.
4. Operate the side street shadow vehicle in the left lane of the dual left turn lanes on the approach to the intersection without encroaching into the intersection. . Do not operate the side street shadow vehicle in the right lane of the dual left turn lanes.
5. Traffic signal work activities conducted under this traffic control setup are restricted to a duration not to exceed 15 minutes. Vacate the intersection in its entirety of all work vehicles, traffic control devices, material and/or personnel immediately upon reaching the end of the 15 minute time period. The intersection, including up to within 500 feet on each approach to the intersection, shall remain clear of all work vehicles, traffic control devices, material and/or personnel for no less than 15 minutes prior to beginning a subsequent traffic signal work activity within the specified limits of the intersection.
6. Conduct all equipment and material preparations prior to entering the roadway.
7. Supplement the side street shadow vehicle with amber colored auxiliary warning lights. The auxiliary warning lights shall be high intensity rotating, flashing, oscillating or strobe lights. Standard vehicle hazard warning lights are only permitted as a supplement to the auxiliary warning lights.

GENERAL NOTES:

1. THIS TRAFFIC CONTROL SETUP IS RESTRICTED TO THOSE TRAFFIC SIGNAL WORK ACTIVITIES CONDUCTED IN THE LEFT TRAVEL LANE OF A MULTILANE ROADWAY THAT DO NOT EXCEED 15 MINUTES. CONDUCT ALL EQUIPMENT AND MATERIAL PREPARATIONS PRIOR TO ENTERING THE ROADWAY.
2. OPERATE THE SIDE STREET SHADOW VEHICLE IN THE LEFT LANE OF THE DUAL LEFT TURN LANES. DO NOT OPERATE THE SIDE STREET SHADOW VEHICLE IN THE RIGHT LANE OF THE DUAL LEFT TURN LANES.

DRAWING 605-05-A(2)
 TRAFFIC SIGNAL
 WORK OPERATIONS
 SIDE STREET TREATMENT
 DUAL LEFT TURN LANES
 WORK VEHICLE - LEFT LANE
 MULTILANE
 PRIMARY & SECONDARY
 ROUTES
 TRAFFIC SIGNAL WORK ACTIVITIES
 COMPLETED IN
 15 MINUTES OR LESS

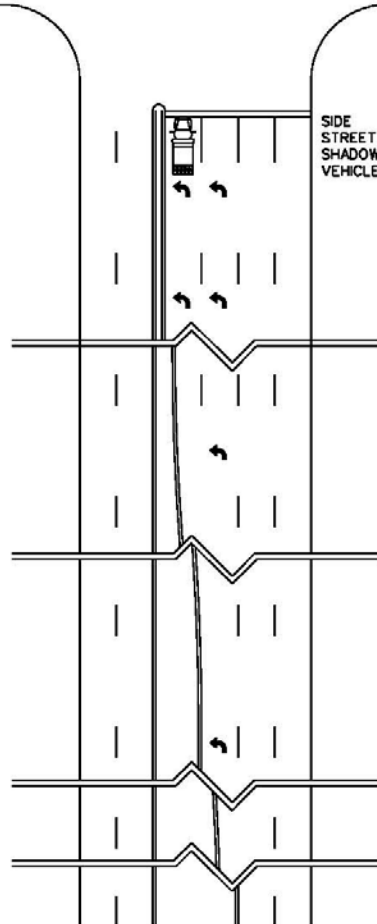
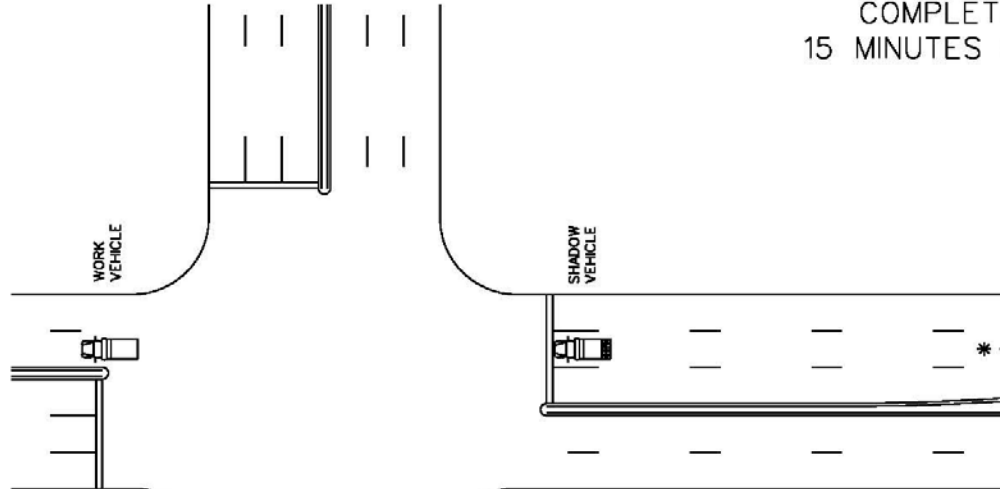

VEHICLE TRAIN

WORK VEHICLE

AMBER COLORED HIGH INTENSITY ROTATING, FLASHING, OSCILLATING OR STROBE LIGHTS ARE REQUIRED ON THE WORK VEHICLE. VEHICLE HAZARD WARNING LIGHTS ARE ONLY PERMITTED AS A SUPPLEMENT TO THESE DEVICES.

SHADOW VEHICLE

AMBER COLORED HIGH INTENSITY ROTATING, FLASHING, OSCILLATING OR STROBE LIGHTS ARE REQUIRED ON THE SHADOW VEHICLE. VEHICLE HAZARD WARNING LIGHTS ARE ONLY PERMITTED AS A SUPPLEMENT TO THESE DEVICES.

A TRUCK MOUNTED ADVANCE WARNING ARROW PANEL DISPLAYING A FLASHING ARROW IS OPTIONAL ON THE SHADOW VEHICLE.

WHEN A LEFT TURN LANE IS PRESENT, OPERATE THE ADVANCE WARNING ARROW PANEL IN THE DOUBLE ARROW MODE WHEN TRAVEL LANES OPEN TO TRAFFIC ARE PRESENT ON EACH SIDE OF THE SHADOW VEHICLE.

A TRUCK MOUNTED ATTENUATOR IS OPTIONAL ON THE SHADOW VEHICLE.

OPERATE THE SHADOW VEHICLE IN THE SAME TRAVEL LANE AS THE WORK VEHICLE ON THE APPROACH TO THE INTERSECTION WITHOUT ENCRDACHING INTO THE INTERSECTION.

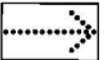

ALTERNATE DISPLAY



SIDE STREET SHADOW VEHICLE

AMBER COLORED HIGH INTENSITY ROTATING, FLASHING, OSCILLATING OR STROBE LIGHTS ARE REQUIRED ON THE SIDE STREET SHADOW VEHICLE. VEHICLE HAZARD WARNING LIGHTS ARE ONLY PERMITTED AS A SUPPLEMENT TO THESE DEVICES.

A TRUCK MOUNTED ADVANCE WARNING ARROW PANEL DISPLAYING A FLASHING ARROW IS REQUIRED ON THE SIDE STREET SHADOW VEHICLE.

A TRUCK MOUNTED ATTENUATOR IS OPTIONAL ON THE SIDE STREET SHADOW VEHICLE.

OPERATE THE SIDE STREET SHADOW VEHICLE IN THE LEFT LANE OF THE DUAL LEFT TURN LANES. DO NOT OPERATE THE SIDE STREET SHADOW VEHICLE IN THE RIGHT LANE OF THE DUAL LEFT TURN LANES.



Drawing No. 605-05-B(1)

**TRAFFIC SIGNAL
WORK OPERATIONS
SIDE STREET TREATMENT
DUAL LEFT TURN LANES
WORK VEHICLE - RIGHT LANE
MULTILANE
PRIMARY & SECONDARY ROUTES
TRAFFIC SIGNAL WORK ACTIVITIES
THAT EXCEED A TIME DURATION
OF 15 MINUTES
BUT NOT MORE THAN 60 MINUTES**

1. This traffic control setup addresses the traffic control for the side street with dual left turn lanes when traffic signal work activities are conducted within the right travel lane of a multilane primary or secondary roadway that exceed a time duration of 15 minutes but not more than 60 minutes. However, this traffic control setup for the side street with dual left turn lanes shall also apply when a standard lane closure is installed to conduct the traffic signal work activities.
2. Avoid conducting traffic signal work or similar work activities that interfere with or create disruptions to normal traffic operations during high traffic volume peak periods when possible.
3. Close the left lane of the dual left turn lanes through installation of traffic control devices. Install the traffic control devices to prevent development of the left lane of the dual left turn lanes. Install the traffic control devices at 25' intervals to delineate the closed left turn lane.
4. No vehicles are required to operate within the closed left turn lane of the side street.

GENERAL NOTES:

1. THIS TRAFFIC CONTROL SETUP ADDRESSES THE TREATMENT OF THE SIDE STREETS DURING TRAFFIC SIGNAL WORK ACTIVITIES THAT EXCEED 15 MINUTES WHEN THE VEHICLE TRAIN OPERATES IN THE RIGHT LANE. THE SIDE STREET TREATMENT ILLUSTRATED HERE SHALL ALSO APPLY WHEN STANDARD LANE CLOSURES ARE REQUIRED AND INSTALLED TO CONDUCT THE TRAFFIC SIGNAL WORK ACTIVITIES.
2. CLOSE THE LEFT LANE OF THE DUAL LEFT TURN LANES. DO NOT CLOSE THE RIGHT LANE OF THE DUAL LEFT TURN LANES. INSTALL THE TRAFFIC CONTROL DEVICES AT 25' INTERVALS TO DELINEATE THE CLOSED LEFT TURN LANE.

DRAWING 605-05-B(1)
TRAFFIC SIGNAL
WORK OPERATIONS
SIDE STREET TREATMENT
DUAL LEFT TURN LANES
WORK VEHICLE - RIGHT LANE
MULTILANE
PRIMARY & SECONDARY
ROUTES
TRAFFIC SIGNAL WORK ACTIVITIES
THAT EXCEED A TIME DURATION
OF 15 MINUTES
BUT NOT MORE THAN 60 MINUTES

INSTALL THESE TRAFFIC CONTROL DEVICES AT INTERVALS NO GREATER THAN 10' FOR CHANNELIZATION OF TRAFFIC TURNING FROM THE SIDE STREETS

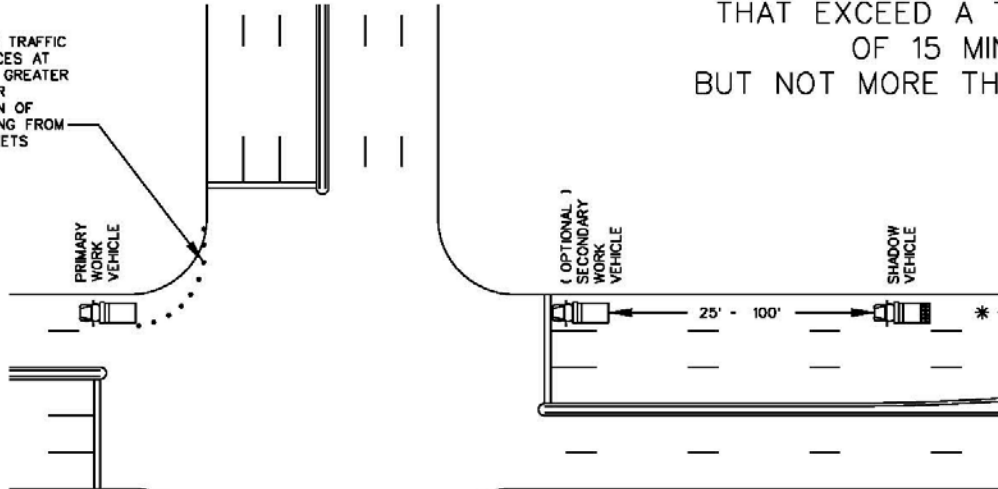

INSTALL TRAFFIC CONTROL DEVICES @ 25' INTERVALS TO CLOSE THE LEFT LANE OF THE DUAL LEFT TURN LANES

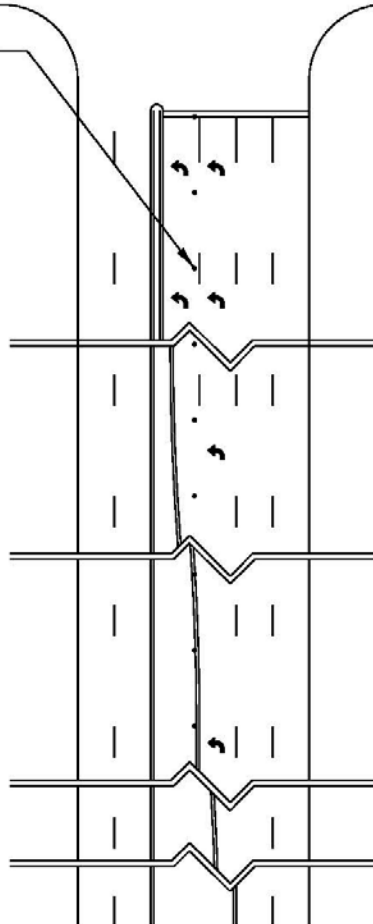

**TRAFFIC SIGNAL
WORK OPERATIONS
SIDE STREET TREATMENT
DUAL LEFT TURN LANES
WORK VEHICLE - LEFT LANE
MULTILANE
PRIMARY & SECONDARY ROUTES
TRAFFIC SIGNAL WORK ACTIVITIES
THAT EXCEED A TIME DURATION
OF 15 MINUTES
BUT NOT MORE THAN 60 MINUTES**

1. This traffic control setup addresses the traffic control for the side street with dual left turn lanes when traffic signal work activities are conducted within the left travel lane of a multilane primary or secondary roadway that exceed a time duration of 15 minutes but not more than 60 minutes. However, this traffic control setup for the side street with dual left turn lanes shall also apply when a standard lane closure is installed to conduct the traffic signal work activities.
2. Avoid conducting traffic signal work or similar work activities that interfere with or create disruptions to normal traffic operations during high traffic volume peak periods when possible.
3. Close the left lane of the dual left turn lanes through installation of traffic control devices. Install the traffic control devices to prevent development of the left lane of the dual left turn lanes. Install the traffic control devices at 25' intervals to delineate the closed left turn lane.
4. Install traffic control devices in advance of the primary work vehicle to channelize traffic turning from the side streets. When sufficient space is available, do not install these traffic control devices within 10' of the near edge of the near right travel lane of the side street crossing the intersection to minimize impacts to the side street through traffic.
5. No vehicles are required to operate within the closed left turn lane of the side street.

DRAWING 605-05-B(2)
 TRAFFIC SIGNAL
 WORK OPERATIONS
 SIDE STREET TREATMENT
 DUAL LEFT TURN LANES
 WORK VEHICLE - LEFT LANE
 MULTILANE
 PRIMARY & SECONDARY
 ROUTES
 TRAFFIC SIGNAL WORK ACTIVITIES
 THAT EXCEED A TIME DURATION
 OF 15 MINUTES
 BUT NOT MORE THAN 60 MINUTES

GENERAL NOTES:

1. THIS TRAFFIC CONTROL SETUP ADDRESSES THE TREATMENT OF THE SIDE STREETS DURING TRAFFIC SIGNAL WORK ACTIVITIES THAT EXCEED 15 MINUTES WHEN THE VEHICLE TRAIN OPERATES IN THE LEFT LANE. THE SIDE STREET TREATMENT ILLUSTRATED HERE SHALL ALSO APPLY WHEN STANDARD LANE CLOSURES ARE REQUIRED AND INSTALLED TO CONDUCT THE TRAFFIC SIGNAL WORK ACTIVITIES.
2. CLOSE THE LEFT LANE OF THE DUAL LEFT TURN LANES. DO NOT CLOSE THE RIGHT LANE OF THE DUAL LEFT TURN LANES. INSTALL THE TRAFFIC CONTROL DEVICES AT 25' INTERVALS TO DELINEATE THE CLOSED LEFT TURN LANE.

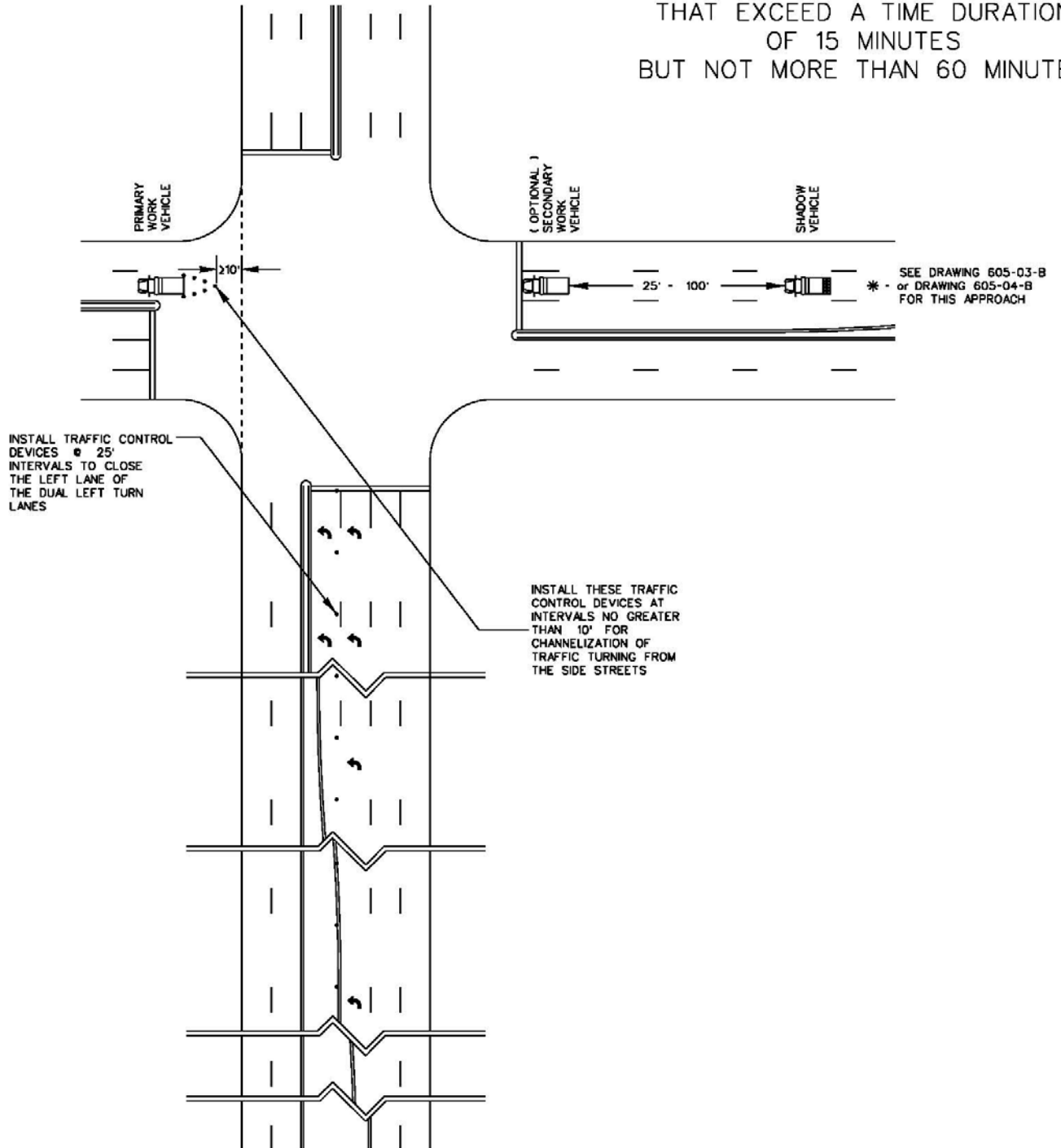

TRAFFIC SIGNAL WORK OPERATIONS

LOOPS

STANDARD DRAWING NO. 606-01

Through

STANDARD DRAWING NO. 606-07

**TRAFFIC SIGNAL
WORK OPERATIONS
VEHICLE TRAIN
TWO-LANE TWO-WAY ROADWAY
PRIMARY & SECONDARY ROUTES
TRAFFIC SIGNAL DETECTION LOOP INSTALLATION
STOP BAR LOOPS**

1. This traffic control setup specifies the traffic control requirements for conducting traffic signal detection loop installation operations, specifically stop bar loops, on two-lane two-way roadways.
This traffic control setup requires installation of multiple flagger flagging operations on all approaches or uniformed law enforcement(s) to control the traffic.
When flaggers are present to control the traffic, place the traffic signal on "normal flashing operations".
When a uniformed law enforcement officer is present to control the traffic, the traffic signal may or may not be placed on "normal flashing operations".
2. Avoid conducting traffic signal detection loop installation operations or similar work activities that interfere with or create disruptions to normal traffic operations during high traffic volume peak periods when possible.
3. Install a multiple flagger flagging operation, including all traffic control devices necessary for a flagging operation, in the roadway where the vehicle train is operating. Only the "Flagger" (W20-7-48) symbol sign is required on the side road approaches intersecting the roadway the vehicle train is operating in. Traffic control devices are not required on the intersecting roadway approaches.
4. The vehicle train shall include the work vehicle and a shadow vehicle.
5. Operate the work vehicle no more than 20' in advance of the work activity site.
6. A shadow vehicle is required in the vehicle train.
A truck mounted advance warning arrow panel operating in the "Four Corner" Caution Mode with one lamp in each corner is optional on the shadow vehicle.
A truck mounted attenuator is optional on the shadow vehicle.
Operate the shadow vehicle in the same travel lane as the work vehicle. Operate the shadow vehicle 25' to 100' in advance of the work vehicle.
7. Supplement all vehicles, including the primary work vehicle and the shadow vehicle, operating in the vehicle train with amber colored high intensity rotating, flashing, oscillating or strobe lights. Standard vehicle hazard warning lights are only permitted as a supplement to the auxiliary warning lights.
8. Maintain two-way radio communications between all flaggers.

DRAWING 606-01
 TRAFFIC SIGNAL
 WORK OPERATIONS
 VEHICLE TRAIN
 TWO-LANE TWO-WAY ROADWAY
 PRIMARY & SECONDARY
 ROUTES
 TRAFFIC SIGNAL DETECTION LOOP
 INSTALLATION
 STOP BAR LOOPS

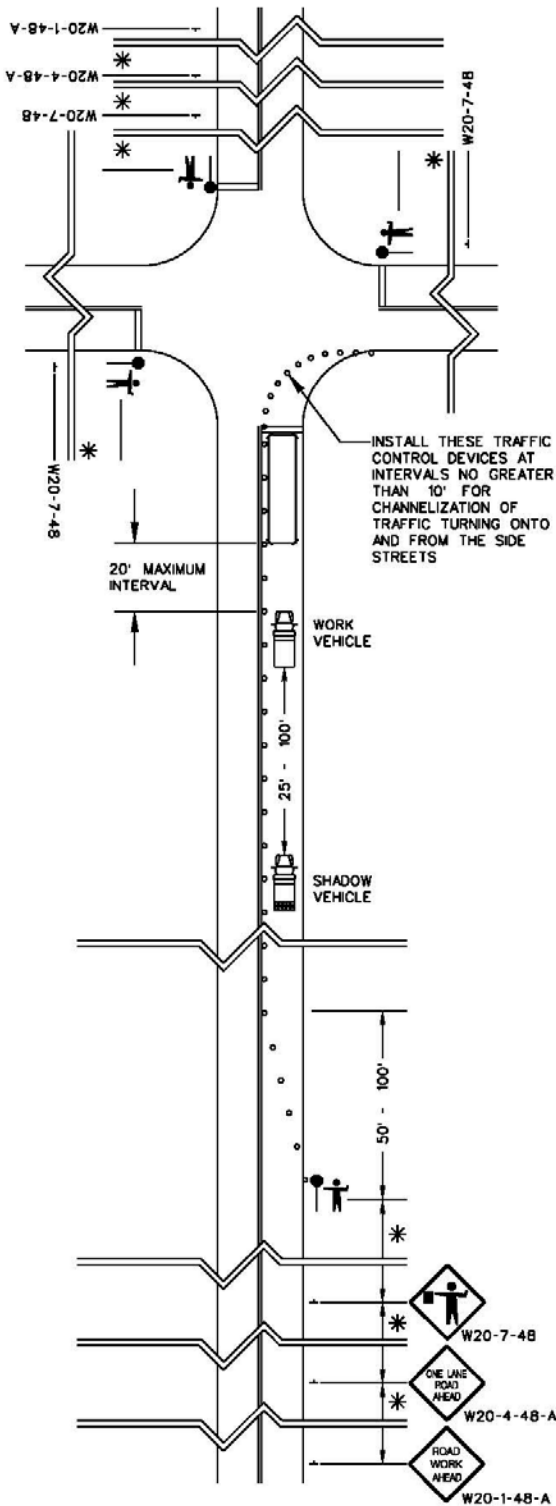

GENERAL NOTES:

1. THIS TRAFFIC CONTROL SETUP ILLUSTRATES AND SPECIFIES THE TRAFFIC CONTROL REQUIREMENTS FOR CONDUCTING TRAFFIC SIGNAL DETECTION LOOP INSTALLATION OPERATIONS ON TWO-LANE TWO-WAY ROADWAYS THAT REQUIRE THE PRESENCE OF PEDESTRIAN WORKERS AND EQUIPMENT WITHIN THE BOUNDARIES OF A TRAVEL LANE.
2. WHEN FLAGGERS OR UNIFORMED LAW ENFORCEMENT OFFICERS ARE REQUIRED TO CONTROL THE TRAFFIC, ONLY THE "FLAGGER" (W20-7-48) SYMBOL SIGN IS REQUIRED ON THE SIDE ROAD APPROACHES TO THE INTERSECTION.
3. WHEN FLAGGERS ARE PRESENT TO CONTROL THE TRAFFIC, PLACE THE TRAFFIC SIGNAL ON "NORMAL FLASHING OPERATIONS".
4. WHEN A UNIFORMED LAW ENFORCEMENT OFFICER(S) IS PRESENT TO CONTROL THE TRAFFIC, THE TRAFFIC SIGNAL MAY OR MAY NOT BE PLACED ON "NORMAL FLASHING OPERATIONS".
5. WHEN FLAGGERS ARE PRESENT TO CONTROL THE TRAFFIC, MAINTAIN TWO-WAY RADIO COMMUNICATIONS BETWEEN ALL FLAGGERS.

VEHICLE TRAIN

WORK VEHICLE

AMBER COLORED HIGH INTENSITY ROTATING, FLASHING, OSCILLATING OR STROBE LIGHTS ARE REQUIRED ON THE WORK VEHICLE. VEHICLE HAZARD WARNING LIGHTS ARE ONLY PERMITTED AS A SUPPLEMENT TO THESE DEVICES.

OPERATE THE WORK VEHICLE NO MORE THAN 20' IN ADVANCE OF THE WORK ACTIVITY SITE.

SHADOW VEHICLE

AMBER COLORED HIGH INTENSITY ROTATING, FLASHING, OSCILLATING OR STROBE LIGHTS ARE REQUIRED ON THE SHADOW VEHICLE. VEHICLE HAZARD WARNING LIGHTS ARE ONLY PERMITTED AS A SUPPLEMENT TO THESE DEVICES.

A TRUCK MOUNTED ADVANCE WARNING ARROW PANEL OPERATING IN THE "FOUR CORNER" CAUTION MODE DISPLAYING FOUR LAMPS WITH ONE IN EACH CORNER IS OPTIONAL ON THE SHADOW VEHICLE.



A TRUCK MOUNTED ATTENUATOR IS OPTIONAL ON THE SHADOW VEHICLE. OPERATE THE SHADOW VEHICLE IN THE SAME TRAVEL LANE AS THE WORK VEHICLE. OPERATE THE SHADOW VEHICLE 25' TO 100' IN ADVANCE OF THE WORK VEHICLE.

TRAFFIC CONTROL DEVICE SPACING INTERVALS WORK ACTIVITY AREA	
SPEED LIMIT	SPACING INTERVALS
≤ 35 MPH	25 FEET
40 - 55 MPH	50 FEET

ADVANCE WARNING SIGN PLACEMENT INTERVALS			
SPEED LIMIT	*	*	*
URBAN / RURAL (LOW SPEED) ≤ 35 MPH	200 FT	200 FT	200 FT
URBAN / RURAL (INTERMEDIATE SPEED) 40 MPH - 50 MPH	350 FT	350 FT	350 FT
RURAL (HIGH SPEED) ≥ 50 MPH	500 FT	500 FT	500 FT

NOTE: THESE SIGN PLACEMENT INTERVALS ARE BASED UPON THE POSTED REGULATORY SPEED LIMIT OF THE ROADWAY PRIOR TO BEGINNING ANY WORK.

**TRAFFIC SIGNAL
WORK OPERATIONS
VEHICLE TRAIN
TWO-LANE TWO-WAY ROADWAY
PRIMARY & SECONDARY ROUTES
TRAFFIC SIGNAL DETECTION LOOP INSTALLATION
SET BACK LOOPS**

1. This traffic control setup specifies the traffic control requirements for conducting traffic signal detection loop installation operations, specifically set back loops, on two-lane two-way roadways.
This traffic control setup requires installation of multiple flagger flagging operations on all approaches or uniformed law enforcement(s) to control the traffic.
When flaggers are present to control the traffic, place the traffic signal on "normal flashing operations".
When a uniformed law enforcement officer is present to control the traffic, the traffic signal may or may not be placed on "normal flashing operations".
2. Avoid conducting traffic signal detection loop installation operations or similar work activities that interfere with or create disruptions to normal traffic operations during high traffic volume peak periods when possible.
3. Install a multiple flagger flagging operation, including all traffic control devices necessary for a flagging operation, in the roadway where the vehicle train is operating. Only the "Flagger" (W20-7-48) symbol sign is required on the side road approaches intersecting the roadway the vehicle train is operating in. Traffic control devices are not required on the intersecting roadway approaches.
4. The vehicle train shall include the work vehicle and a shadow vehicle.
5. Operate the work vehicle no more than 20' beyond the work activity site.
6. A shadow vehicle is required in the vehicle train.
A truck mounted advance warning arrow panel operating in the "Four Corner" Caution Mode with one lamp in each corner is optional on the shadow vehicle.
A truck mounted attenuator is optional on the shadow vehicle.
Operate the shadow vehicle in the same travel lane as the work vehicle. Operate the shadow vehicle 25' to 100' in advance of the work activity site.
7. Supplement all vehicles, including the primary work vehicle, the secondary work vehicle and the shadow vehicle, operating in the vehicle train with amber colored high intensity rotating, flashing, oscillating or strobe lights. Standard vehicle hazard warning lights are only permitted as a supplement to the auxiliary warning lights.
8. Maintain two-way radio communications between all flaggers.

DRAWING 606-02
 TRAFFIC SIGNAL
 WORK OPERATIONS
 VEHICLE TRAIN
 TWO-LANE TWO-WAY ROADWAY
 PRIMARY & SECONDARY
 ROUTES
 TRAFFIC SIGNAL DETECTION LOOP
 INSTALLATION
 SET BACK LOOPS

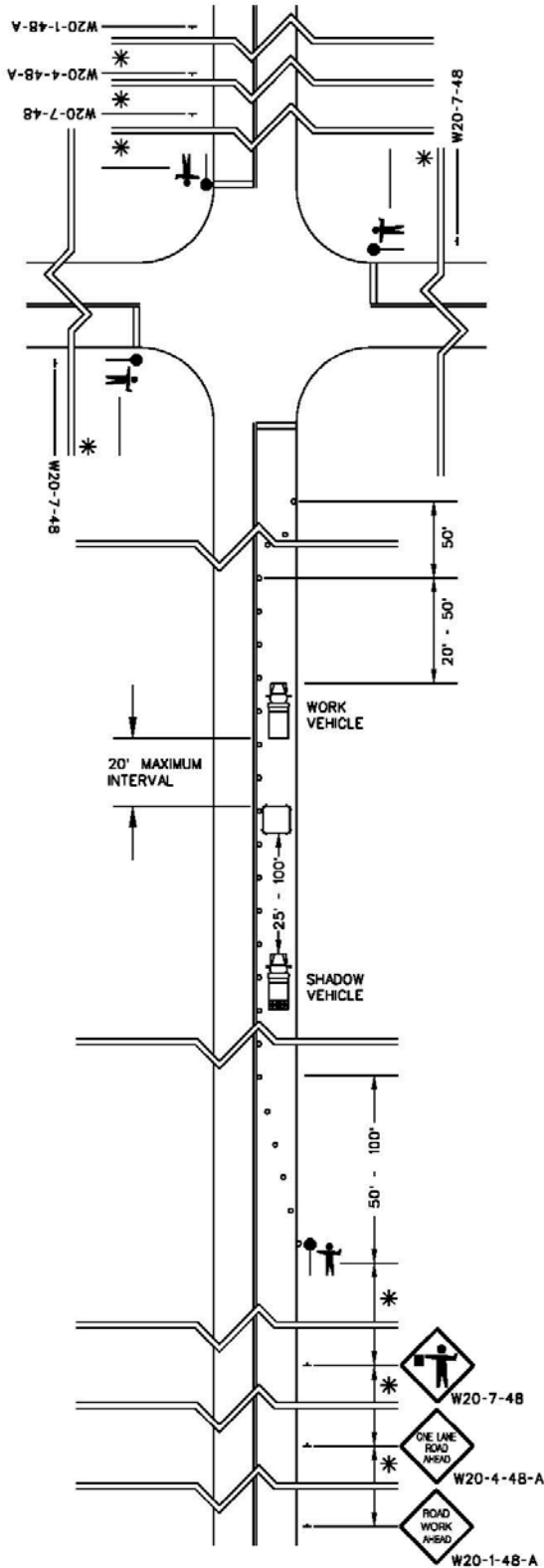

TRAFFIC CONTROL DEVICE SPACING INTERVALS WORK ACTIVITY AREA	
SPEED LIMIT	SPACING INTERVALS
≤ 35 MPH	25 FEET
40 - 55 MPH	50 FEET

GENERAL NOTES:

1. THIS TRAFFIC CONTROL SETUP ILLUSTRATES AND SPECIFIES THE TRAFFIC CONTROL REQUIREMENTS FOR CONDUCTING TRAFFIC SIGNAL DETECTION LOOP INSTALLATION OPERATIONS ON TWO-LANE TWO-WAY ROADWAYS THAT REQUIRE THE PRESENCE OF PEDESTRIAN WORKERS AND EQUIPMENT WITHIN THE BOUNDARIES OF A TRAVEL LANE.
2. WHEN FLAGGERS OR UNIFORMED LAW ENFORCEMENT OFFICERS ARE REQUIRED TO CONTROL THE TRAFFIC, ONLY THE "FLAGGER" (W20-7-48) SYMBOL SIGN IS REQUIRED ON THE SIDE ROAD APPROACHES TO THE INTERSECTION.
3. WHEN FLAGGERS ARE PRESENT TO CONTROL THE TRAFFIC, PLACE THE TRAFFIC SIGNAL ON "NORMAL FLASHING OPERATIONS".
4. WHEN A UNIFORMED LAW ENFORCEMENT OFFICER(S) IS PRESENT TO CONTROL THE TRAFFIC, THE TRAFFIC SIGNAL MAY OR MAY NOT BE PLACED ON "NORMAL FLASHING OPERATIONS".
5. WHEN FLAGGERS ARE PRESENT TO CONTROL THE TRAFFIC, MAINTAIN TWO-WAY RADIO COMMUNICATIONS BETWEEN ALL FLAGGERS.

VEHICLE TRAIN

WORK VEHICLE

AMBER COLORED HIGH INTENSITY ROTATING, FLASHING, OSCILLATING OR STROBE LIGHTS ARE REQUIRED ON THE WORK VEHICLE. VEHICLE HAZARD WARNING LIGHTS ARE ONLY PERMITTED AS A SUPPLEMENT TO THESE DEVICES.
 OPERATE THE WORK VEHICLE NO MORE THAN 20' BEYOND THE WORK ACTIVITY SITE.

SHADOW VEHICLE

AMBER COLORED HIGH INTENSITY ROTATING, FLASHING, OSCILLATING OR STROBE LIGHTS ARE REQUIRED ON THE SHADOW VEHICLE. VEHICLE HAZARD WARNING LIGHTS ARE ONLY PERMITTED AS A SUPPLEMENT TO THESE DEVICES.
 A TRUCK MOUNTED ADVANCE WARNING ARROW PANEL OPERATING IN THE "FOUR CORNER" CAUTION MODE DISPLAYING FOUR LAMPS WITH ONE IN EACH CORNER IS OPTIONAL ON THE SHADOW VEHICLE.
 A TRUCK MOUNTED ATTENUATOR IS OPTIONAL ON THE SHADOW VEHICLE.
 OPERATE THE SHADOW VEHICLE IN THE SAME TRAVEL LANE AS THE WORK VEHICLE. OPERATE THE SHADOW VEHICLE 25' TO 100' IN ADVANCE OF THE WORK ACTIVITY SITE.

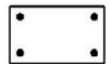

ADVANCE WARNING SIGN PLACEMENT INTERVALS			
SPEED LIMIT	*	*	*
URBAN / RURAL (LOW SPEED) ≤ 35 MPH	200 FT	200 FT	200 FT
URBAN / RURAL (INTERMEDIATE SPEED) 40 MPH - 50 MPH	350 FT	350 FT	350 FT
RURAL (HIGH SPEED) ≥ 50 MPH	500 FT	500 FT	500 FT

NOTE: THESE SIGN PLACEMENT INTERVALS ARE BASED UPON THE POSTED REGULATORY SPEED LIMIT OF THE ROADWAY PRIOR TO BEGINNING ANY WORK.

**TRAFFIC SIGNAL
WORK OPERATIONS
VEHICLE TRAIN
RIGHT LANE CLOSURE
MULTILANE
PRIMARY & SECONDARY ROUTES
TRAFFIC SIGNAL DETECTION LOOP INSTALLATION
STOP BAR LOOPS**

1. This traffic control setup specifies the traffic control requirements for conducting traffic signal detection loop installation operations, specifically stop bar loops, within the right travel lane of a multilane primary or secondary roadway.
2. Avoid conducting traffic signal detection loop installation operations or similar work activities that interfere with or create disruptions to normal traffic operations during high traffic volume peak periods when possible.
3. Prior to the vehicle train entering the roadway, install the advance warning signs as illustrated. Traffic control devices such as standard traffic cones, 42" oversized traffic cones or portable plastic drums may be used for delineation of the work area. Consider installation of these traffic control devices, however, installation of these traffic control devices is not required.
4. The vehicle train shall include the work vehicle and a shadow vehicle.
5. Operate the work vehicle no more than 20' in advance of the work activity site.
6. A shadow vehicle is required in the vehicle train.
A truck mounted advance warning arrow panel displaying a flashing arrow is required on the shadow vehicle. When a right turn lane is present, operate the truck mounted advance warning arrow panel in the double arrow mode when travel lanes open to traffic are present on each side of the shadow vehicle.
A truck mounted attenuator is required on the shadow vehicle.
Operate the shadow vehicle in the same travel lane as the work vehicle. Operate the shadow vehicle 25' to 100' in advance of the work vehicle.
7. Supplement the work vehicle and the shadow vehicle with amber colored auxiliary warning lights. The auxiliary warning lights shall be high intensity rotating, flashing, oscillating or strobe lights. Standard vehicle hazard warning lights are only permitted as a supplement to the auxiliary warning lights.

DRAWING 606-03
 TRAFFIC SIGNAL
 WORK OPERATIONS
 VEHICLE TRAIN
 RIGHT LANE CLOSURE
 MULTILANE
 PRIMARY & SECONDARY
 ROUTES
 TRAFFIC SIGNAL DETECTION LOOP
 INSTALLATION
 STOP BAR LOOPS

INSTALL THESE TRAFFIC CONTROL DEVICES WITHIN THE TURN RADIUS AT INTERVALS NO GREATER THAN 10' FOR CHANNELIZATION OF TRAFFIC TURNING ONTO THE SIDE STREET

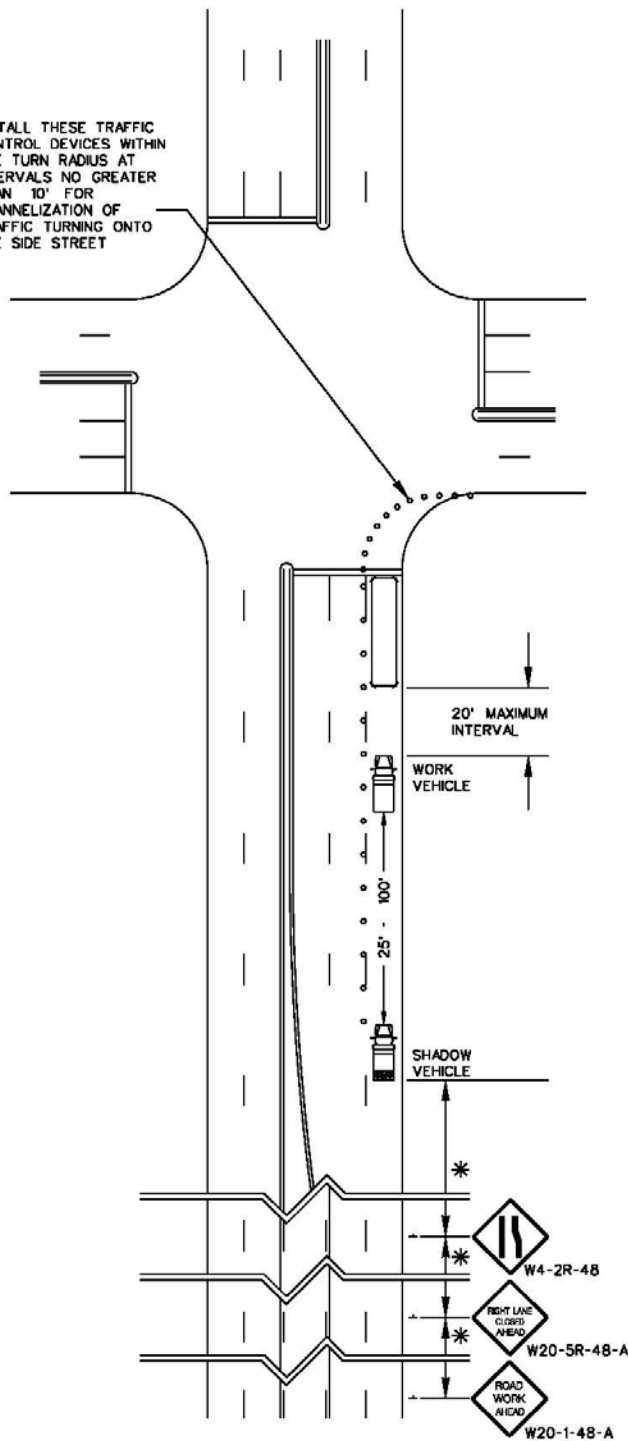

GENERAL NOTES:

1. THIS TRAFFIC CONTROL SETUP ILLUSTRATES AND SPECIFIES THE TRAFFIC CONTROL REQUIREMENTS FOR CONDUCTING TRAFFIC SIGNAL DETECTION LOOP INSTALLATION OPERATIONS, SPECIFICALLY STOP BAR LOOPS, WITHIN THE RIGHT TRAVEL LANE OF A MULTILANE PRIMARY OR SECONDARY ROADWAY THAT REQUIRE THE PRESENCE OF PEDESTRIAN WORKERS AND EQUIPMENT WITHIN THE BOUNDARIES OF A TRAVEL LANE.
2. ON MULTILANE ROADWAYS, THE VEHICLE TRAIN SHALL INCLUDE THE WORK VEHICLE AND A SHADOW VEHICLE.
3. TRAFFIC CONTROL DEVICES SUCH AS STANDARD TRAFFIC CONES, 42" OVERSIZED TRAFFIC CONES OR PORTABLE PLASTIC DRUMS MAY BE USED FOR DELINEATION OF THE WORK AREA. WHEN UTILIZING THESE TRAFFIC CONTROL DEVICES, INSTALL AND MAINTAIN THESE TRAFFIC CONTROL DEVICES AS ILLUSTRATED.

VEHICLE TRAIN

WORK VEHICLE

AMBER COLORED HIGH INTENSITY ROTATING, FLASHING, OSCILLATING OR STROBE LIGHTS ARE REQUIRED ON THE WORK VEHICLE. VEHICLE HAZARD WARNING LIGHTS ARE ONLY PERMITTED AS A SUPPLEMENT TO THESE DEVICES.

OPERATE THE WORK VEHICLE NO MORE THAN 20' IN ADVANCE OF THE WORK ACTIVITY SITE.

SHADOW VEHICLE

AMBER COLORED HIGH INTENSITY ROTATING, FLASHING, OSCILLATING OR STROBE LIGHTS ARE REQUIRED ON THE SHADOW VEHICLE. VEHICLE HAZARD WARNING LIGHTS ARE ONLY PERMITTED AS A SUPPLEMENT TO THESE DEVICES.

A TRUCK MOUNTED ADVANCE WARNING ARROW PANEL DISPLAYING A FLASHING ARROW IS REQUIRED ON THE SHADOW VEHICLE.

WHEN A RIGHT TURN LANE IS PRESENT, OPERATE THE ADVANCE WARNING ARROW PANEL IN THE DOUBLE ARROW MODE WHEN TRAVEL LANES OPEN TO TRAFFIC ARE PRESENT ON EACH SIDE OF THE SHADOW VEHICLE.

A TRUCK MOUNTED ATTENUATOR IS REQUIRED ON THE SHADOW VEHICLE.

OPERATE THE SHADOW VEHICLE IN THE SAME TRAVEL LANE AS THE WORK VEHICLE. OPERATE THE SHADOW VEHICLE 25' TO 100' IN ADVANCE OF THE WORK VEHICLE.

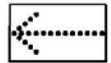

ALTERNATE DISPLAY

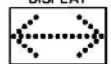

TRAFFIC CONTROL DEVICE SPACING INTERVALS WORK ACTIVITY AREA	
SPEED LIMIT	SPACING INTERVALS
≤ 35 MPH	25 FEET
40 - 55 MPH	50 FEET

ADVANCE WARNING SIGN PLACEMENT INTERVALS			
SPEED LIMIT	*	*	*
URBAN / RURAL (LOW SPEED) ≤ 35 MPH	200 FT	200 FT	200 FT
URBAN / RURAL (INTERMEDIATE SPEED) 40 MPH - 50 MPH	350 FT	350 FT	350 FT
RURAL (HIGH SPEED) ≥ 50 MPH	500 FT	500 FT	500 FT

NOTE: THESE SIGN PLACEMENT INTERVALS ARE BASED UPON THE POSTED REGULATORY SPEED LIMIT OF THE ROADWAY PRIOR TO BEGINNING ANY WORK.

**TRAFFIC SIGNAL
WORK OPERATIONS
VEHICLE TRAIN
INTERIOR LANE CLOSURE
MULTILANE
PRIMARY & SECONDARY ROUTES
w/ 2 THROUGH LANES
TRAFFIC SIGNAL DETECTION LOOP INSTALLATION
STOP BAR LOOPS**

1. This traffic control setup specifies the traffic control requirements for conducting traffic signal detection loop installation operations, specifically stop bar loops, within an interior travel lane of a multilane primary or secondary roadway with two through lanes.
2. Avoid conducting traffic signal detection loop installation operations or similar work activities that interfere with or create disruptions to normal traffic operations during high traffic volume peak periods when possible.
3. Prior to the vehicle train entering the roadway, install the advance warning signs as illustrated. Traffic control devices such as standard traffic cones, 42" oversized traffic cones or portable plastic drums may be used for delineation of the work area. Consider installation of these traffic control devices, however, installation of these traffic control devices is not required.
4. The vehicle train shall include the work vehicle and a shadow vehicle.
5. Operate the work vehicle no more than 20' in advance of the work activity site.
6. A shadow vehicle is required in the vehicle train.
A truck mounted advance warning arrow panel displaying a flashing arrow is required on the shadow vehicle. When a left turn lane is present, operate the truck mounted advance warning arrow panel in the double arrow mode when travel lanes open to traffic are present on each side of the shadow vehicle.
A truck mounted attenuator is required on the shadow vehicle.
Operate the shadow vehicle in the same travel lane as the work vehicle. Operate the shadow vehicle 25' to 100' in advance of the work vehicle.
7. Supplement the work vehicle and the shadow vehicle with amber colored auxiliary warning lights. The auxiliary warning lights shall be high intensity rotating, flashing, oscillating or strobe lights. Standard vehicle hazard warning lights are only permitted as a supplement to the auxiliary warning lights.
8. For the traffic control setup requirements for connecting the stop bar loop within an interior travel lane to the pull box in the adjacent shoulder, see Drawing 606-04-B.

DRAWING 606-04-A
 TRAFFIC SIGNAL
 WORK OPERATIONS
 VEHICLE TRAIN
 INTERIOR LANE CLOSURE
 MULTILANE
 PRIMARY & SECONDARY
 ROUTES w/
 2 THROUGH LANES
 TRAFFIC SIGNAL DETECTION LOOP
 INSTALLATION
 STOP BAR LOOPS

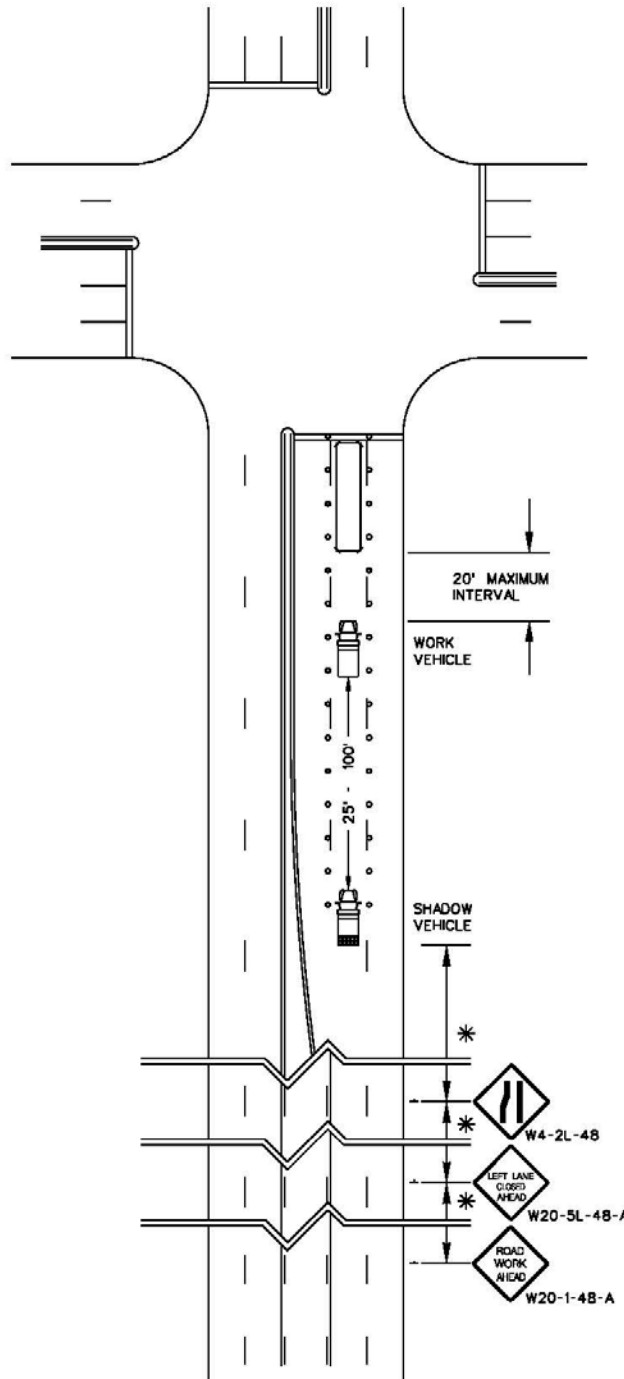

GENERAL NOTES:

1. THIS TRAFFIC CONTROL SETUP ILLUSTRATES AND SPECIFIES THE TRAFFIC CONTROL REQUIREMENTS FOR CONDUCTING TRAFFIC SIGNAL DETECTION LOOP INSTALLATION OPERATIONS, SPECIFICALLY STOP BAR LOOPS, WITHIN AN INTERIOR TRAVEL LANE OF A MULTILANE PRIMARY OR SECONDARY ROADWAY THAT REQUIRES THE PRESENCE OF PEDESTRIAN WORKERS AND EQUIPMENT WITHIN THE BOUNDARIES OF A TRAVEL LANE.
2. THE VEHICLE TRAIN SHALL INCLUDE THE WORK VEHICLE AND A SHADOW VEHICLE.
3. TRAFFIC CONTROL DEVICES SUCH AS STANDARD TRAFFIC CONES, 42" OVERSIZED TRAFFIC CONES OR PORTABLE PLASTIC DRUMS MAY BE USED FOR DELINEATION OF THE WORK AREA. WHEN UTILIZING THESE TRAFFIC CONTROL DEVICES, INSTALL AND MAINTAIN THESE TRAFFIC CONTROL DEVICES AS ILLUSTRATED.

VEHICLE TRAIN

WORK VEHICLE

AMBER COLORED HIGH INTENSITY ROTATING, FLASHING, OSCILLATING OR STROBE LIGHTS ARE REQUIRED ON THE WORK VEHICLE. VEHICLE HAZARD WARNING LIGHTS ARE ONLY PERMITTED AS A SUPPLEMENT TO THESE DEVICES.
 OPERATE THE WORK VEHICLE NO MORE THAN 20' IN ADVANCE OF THE WORK ACTIVITY SITE.

SHADOW VEHICLE

AMBER COLORED HIGH INTENSITY ROTATING, FLASHING, OSCILLATING OR STROBE LIGHTS ARE REQUIRED ON THE SHADOW VEHICLE. VEHICLE HAZARD WARNING LIGHTS ARE ONLY PERMITTED AS A SUPPLEMENT TO THESE DEVICES.
 A TRUCK MOUNTED ADVANCE WARNING ARROW PANEL DISPLAYING A FLASHING ARROW IS REQUIRED ON THE SHADOW VEHICLE.
 WHEN A LEFT TURN LANE IS PRESENT, OPERATE THE ADVANCE WARNING ARROW PANEL IN THE DOUBLE ARROW MODE WHEN TRAVEL LANES OPEN TO TRAFFIC ARE PRESENT ON EACH SIDE OF THE SHADOW VEHICLE.
 A TRUCK MOUNTED ATTENUATOR IS REQUIRED ON THE SHADOW VEHICLE.
 OPERATE THE SHADOW VEHICLE IN THE SAME TRAVEL LANE AS THE WORK VEHICLE. OPERATE THE SHADOW VEHICLE 25' TO 100' IN ADVANCE OF THE WORK VEHICLE.

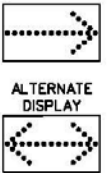

TRAFFIC CONTROL DEVICE SPACING INTERVALS WORK ACTIVITY AREA	
SPEED LIMIT	SPACING INTERVALS
≤ 35 MPH	25 FEET
40 - 55 MPH	50 FEET

ADVANCE WARNING SIGN PLACEMENT INTERVALS			
SPEED LIMIT	*	*	*
URBAN / RURAL (LOW SPEED) ≤ 35 MPH	200 FT	200 FT	200 FT
URBAN / RURAL (INTERMEDIATE SPEED) 40 MPH - 50 MPH	350 FT	350 FT	350 FT
RURAL (HIGH SPEED) ≥ 50 MPH	500 FT	500 FT	500 FT

NOTE: THESE SIGN PLACEMENT INTERVALS ARE BASED UPON THE POSTED REGULATORY SPEED LIMIT OF THE ROADWAY PRIOR TO BEGINNING ANY WORK.

**TRAFFIC SIGNAL
WORK OPERATIONS
VEHICLE TRAIN
INTERIOR LANE CLOSURE
MULTILANE
PRIMARY & SECONDARY ROUTES
w/ 2 THROUGH LANES
CONNECTING THE STOP BAR LOOP
TO THE PULL BOX**

1. This traffic control setup specifies the traffic control requirements for connecting the stop bar loop within an interior travel lane of a multilane primary or secondary roadway to the pull box in the adjacent shoulder. The saw cut and wire installation operations require the presence of pedestrian workers and equipment within the boundaries of a travel lane.
2. Avoid conducting these work activities during high traffic volume peak periods when possible.
3. The vehicle train that operated in the travel lanes during the stop bar loop installation operations is not required during the saw cut and wire installation operations, however, the vehicle train may remain in place during the saw cut and wire installation operations to provide a secure area for the pedestrian workers to retreat to in the event of an errant vehicle. Maintain the advance warning signs relative to the vehicle train if the vehicle train is maintained in place.
4. If traffic control devices are used to supplement the vehicle train and delineate the work area during installation of the stop bar loop, maintain these devices in place when the vehicle train remains during the saw cut and wire installation operations. If the vehicle train is discontinued and removed during the saw cut and wire installation operations, also remove the traffic control devices.
5. Prior to beginning the saw cut and wire installation operations, stop traffic in all travel lanes approaching the work area.
6. Requirements for a temporary cessation of traffic flow are as follows:

A temporary cessation of traffic flow is permissible during non-peak traffic periods, as directed by the District Traffic Engineer, to conduct saw cut and wire installation operations to connect a stop bar loop within an interior travel lane of a multilane primary or secondary roadway to the pull box in the adjacent shoulder. The temporary cessation of traffic flow shall not exceed 3 minutes. The temporary cessation of traffic flow shall apply to all travel lanes in the same direction. Utilize flaggers, properly equipped with stop/slow paddles, to stop the traffic flow. No less than one (1) flagger is required for each travel lane occupied by traffic intended to be stopped. The flaggers should enter the roadway during a gap in the traffic flow to permit motorists sufficient space to come to a safe stop. Immediately prior to completion of the 3 minute time interval, all workers shall remove equipment relative to the saw cut and wire installation operations and vacate the travel lanes to permit the flaggers to release the stopped traffic. When the vehicle train is maintained, the vehicle train may remain in place when the stopped traffic in the adjacent travel lanes is released. Allow all stopped traffic to clear the work site prior to stopping traffic again.

Daytime Operations –

Utilize and install “Be Prepared To Stop” signs (W3-4-48), one on each shoulder, in advance of the location of the flaggers. Utilize the table, “Advance Warning Sign Placement Intervals” as a guide for a minimum distance for placement of the “Be Prepared To Stop” signs. Depending upon the traffic volumes, greater distances may be required to ensure the “Be Prepared To Stop” signs are in advance of any traffic queues that may develop.

Nighttime Operations –

Illuminate the flagger locations. All flaggers shall wear Class 3 High Visibility safety apparel that meet the ANSI/ISEA 107 requirements and a fluorescent hardhat. Utilize a changeable message sign displaying the message, “Prepare To Stop”, at a minimum character height of 18 inches. Place the changeable message sign at a location in advance of the anticipated traffic queues.

DRAWING 606-04-B
 TRAFFIC SIGNAL
 WORK OPERATIONS
 TEMPORARY CESSATION
 OF TRAFFIC FLOW
 MULTILANE
 PRIMARY & SECONDARY
 ROUTES w/
 2 THROUGH LANES
 CONNECTING THE STOP BAR LOOP
 TO THE PULL BOX

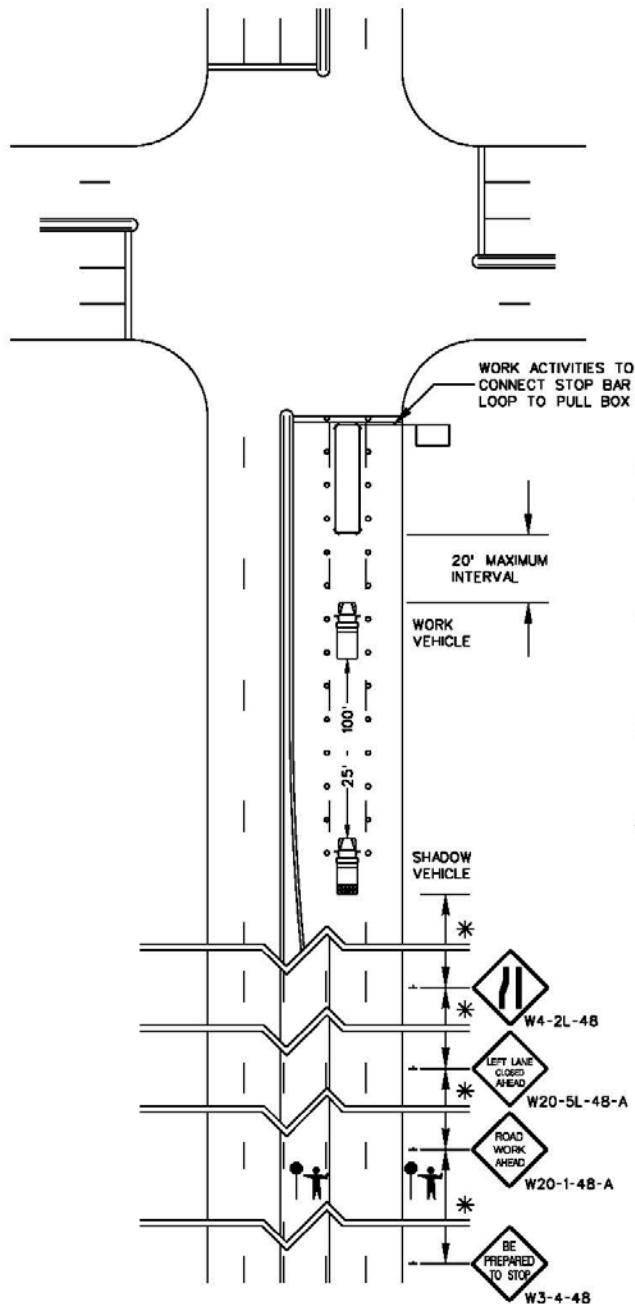

GENERAL NOTES:

1. THIS TRAFFIC CONTROL SETUP ILLUSTRATES AND SPECIFIES THE TRAFFIC CONTROL REQUIREMENTS FOR CONNECTING THE STOP BAR LOOP WITHIN AN INTERIOR TRAVEL LANE OF A MULTILANE PRIMARY OR SECONDARY ROADWAY TO THE PULL BOX IN THE ADJACENT SHOULDER. THE SAW CUT AND WIRE INSTALLATION OPERATIONS REQUIRE THE PRESENCE OF PEDESTRIAN WORKERS AND EQUIPMENT WITHIN THE BOUNDARIES OF A TRAVEL LANE.
2. THE VEHICLE TRAIN THAT OPERATED IN THE TRAVEL LANES DURING THE STOP BAR LOOP INSTALLATION OPERATIONS IS NOT REQUIRED DURING THE SAW CUT AND WIRE INSTALLATION OPERATIONS, HOWEVER, THE VEHICLE TRAIN MAY REMAIN IN PLACE TO PROVIDE A SECURE AREA FOR THE PEDESTRIAN WORKERS TO RETREAT TO IN THE EVENT OF AN ERRANT VEHICLE. MAINTAIN THE ADVANCE WARNING SIGNS RELATIVE TO THE VEHICLE TRAIN IF THE VEHICLE TRAIN IS MAINTAINED IN PLACE.
3. IF TRAFFIC CONTROL DEVICES ARE USED TO SUPPLEMENT THE VEHICLE TRAIN AND DELINEATE THE ORIGINAL WORK AREA, MAINTAIN THESE DEVICES IN PLACE WHEN THE VEHICLE TRAIN REMAINS DURING THE SAW CUT AND WIRE INSTALLATION OPERATIONS. IF THE VEHICLE TRAIN IS DISCONTINUED AND REMOVED DURING THE SAW CUT AND WIRE INSTALLATION OPERATIONS, ALSO REMOVE THE TRAFFIC CONTROL DEVICES.
4. PRIOR TO BEGINNING THE SAW CUT AND WIRE INSTALLATION OPERATIONS, STOP TRAFFIC IN ALL TRAVEL LANES APPROACHING THE WORK AREA AS DIRECTED BY THE "REQUIREMENTS FOR A TEMPORARY CESSATION OF TRAFFIC FLOW".

ADVANCE WARNING SIGN PLACEMENT INTERVALS			
SPEED LIMIT	*	*	*
URBAN / RURAL (LOW SPEED) ≤ 35 MPH	200 FT	200 FT	200 FT
URBAN / RURAL (INTERMEDIATE SPEED) 40 MPH - 50 MPH	350 FT	350 FT	350 FT
RURAL (HIGH SPEED) ≥ 50 MPH	500 FT	500 FT	500 FT

NOTE: THESE SIGN PLACEMENT INTERVALS ARE BASED UPON THE POSTED REGULATORY SPEED LIMIT OF THE ROADWAY PRIOR TO BEGINNING ANY WORK.

REQUIREMENTS FOR A TEMPORARY CESSATION OF TRAFFIC FLOW

A TEMPORARY CESSATION OF TRAFFIC FLOW IS PERMISSIBLE DURING NON-PEAK TRAFFIC PERIODS, AS DIRECTED BY THE DISTRICT TRAFFIC ENGINEER, TO CONDUCT SAW CUT AND WIRE INSTALLATION OPERATIONS TO CONNECT A STOP BAR LOOP WITHIN AN INTERIOR TRAVEL LANE OF A MULTILANE PRIMARY OR SECONDARY ROADWAY TO THE PULL BOX IN THE ADJACENT SHOULDER. THE TEMPORARY CESSATION OF TRAFFIC FLOW SHALL NOT EXCEED A DURATION OF 3 MINUTES. THE TEMPORARY CESSATION OF TRAFFIC FLOW SHALL APPLY TO ALL TRAVEL LANES IN THE SAME DIRECTION. UTILIZE FLAGGERS, PROPERLY EQUIPPED WITH STOP/SLOW PADDLES, TO STOP THE TRAFFIC FLOW. NO LESS THAN ONE (1) FLAGGER IS REQUIRED FOR EACH TRAVEL LANE OCCUPIED BY TRAFFIC INTENDED TO BE STOPPED. THE FLAGGERS SHOULD ENTER THE ROADWAY DURING A GAP IN THE TRAFFIC FLOW TO PERMIT MOTORISTS SUFFICIENT SPACE TO COME TO A SAFE STOP. IMMEDIATELY PRIOR TO COMPLETION OF THE 3 MINUTE TIME INTERVAL, ALL WORKERS SHALL REMOVE EQUIPMENT RELATIVE TO THE SAW CUT AND WIRE INSTALLATION OPERATIONS AND VACATE THE TRAVEL LANES TO PERMIT THE FLAGGERS TO RELEASE THE STOPPED TRAFFIC. WHEN THE VEHICLE TRAIN IS MAINTAINED, THE VEHICLE TRAIN MAY REMAIN IN PLACE WHEN THE STOPPED TRAFFIC IN THE ADJACENT TRAVEL LANES IS RELEASED. ALLOW ALL STOPPED TRAFFIC TO CLEAR THE WORK SITE PRIOR TO STOPPING TRAFFIC AGAIN.

DAYTIME OPERATIONS -

UTILIZE AND INSTALL "BE PREPARED TO STOP" SIGNS (W3-4-4B), ONE ON EACH SHOULDER, IN ADVANCE OF THE LOCATION OF THE FLAGGERS. UTILIZE THE TABLE, "ADVANCE WARNING SIGN PLACEMENT INTERVALS" AS A GUIDE FOR A MINIMUM DISTANCE FOR PLACEMENT OF THE "BE PREPARED TO STOP" SIGNS. DEPENDING UPON TRAFFIC VOLUMES, GREATER DISTANCES MAY BE REQUIRED TO ENSURE THE "BE PREPARED TO STOP" SIGNS ARE IN ADVANCE OF THE TRAFFIC QUEUES.

NIGHTTIME OPERATIONS -

ILLUMINATE THE FLAGGER LOCATIONS. ALL FLAGGERS SHALL WEAR CLASS 3 HIGH VISIBILITY SAFETY APPAREL THAT MEET THE ANSI/ISEA 107 REQUIREMENTS AND A FLUORESCENT HARDHAT. UTILIZE A CHANGEABLE MESSAGE SIGN DISPLAYING THE MESSAGE, "PREPARE TO STOP", AT A MINIMUM CHARACTER HEIGHT OF 18 INCHES. PLACE THE CHANGEABLE MESSAGE SIGN AT A LOCATION IN ADVANCE OF THE ANTICIPATED TRAFFIC QUEUES.

**TRAFFIC SIGNAL
WORK OPERATIONS
VEHICLE TRAIN
INTERIOR LANE CLOSURE
MULTILANE
PRIMARY & SECONDARY ROUTES
w/ 3 OR MORE THROUGH LANES
TRAFFIC SIGNAL DETECTION LOOP INSTALLATION
STOP BAR LOOPS**

1. This traffic control setup specifies the traffic control requirements for conducting traffic signal detection loop installation operations, specifically stop bar loops, within an interior travel lane of a multilane primary or secondary roadway with three through lanes.
2. Avoid conducting traffic signal detection loop installation operations or similar work activities that interfere with or create disruptions to normal traffic operations during high traffic volume peak periods when possible.
3. Prior to the vehicle train entering the roadway, install the advance warning signs as illustrated. Traffic control devices such as standard traffic cones, 42" oversized traffic cones or portable plastic drums may be used for delineation of the work area. Consider installation of these traffic control devices, however, installation of these traffic control devices is not required.
4. The vehicle train shall include the work vehicle and a shadow vehicle.
5. Operate the work vehicle no more than 20' in advance of the work activity site.
6. A shadow vehicle is required in the vehicle train.
A truck mounted advance warning arrow panel displaying a flashing arrow is required on the shadow vehicle. When a left turn lane is present, operate the truck mounted advance warning arrow panel in the double arrow mode when travel lanes open to traffic are present on each side of the shadow vehicle.
A truck mounted attenuator is required on the shadow vehicle.
Operate the shadow vehicle in the same travel lane as the work vehicle. Operate the shadow vehicle 25' to 100' in advance of the work vehicle.
7. Supplement the work vehicle and the shadow vehicle with amber colored auxiliary warning lights. The auxiliary warning lights shall be high intensity rotating, flashing, oscillating or strobe lights. Standard vehicle hazard warning lights are only permitted as a supplement to the auxiliary warning lights.
8. For the traffic control setup requirements for connecting the stop bar loop within an interior travel lane to the pull box in the adjacent shoulder, see Drawing 606-05-B.

DRAWING 606-05-A
 TRAFFIC SIGNAL
 WORK OPERATIONS
 VEHICLE TRAIN
 INTERIOR LANE CLOSURE
 MULTILANE
 PRIMARY & SECONDARY
 ROUTES w/
 3 OR MORE THROUGH LANES
 TRAFFIC SIGNAL DETECTION LOOP
 INSTALLATION
 STOP BAR LOOPS

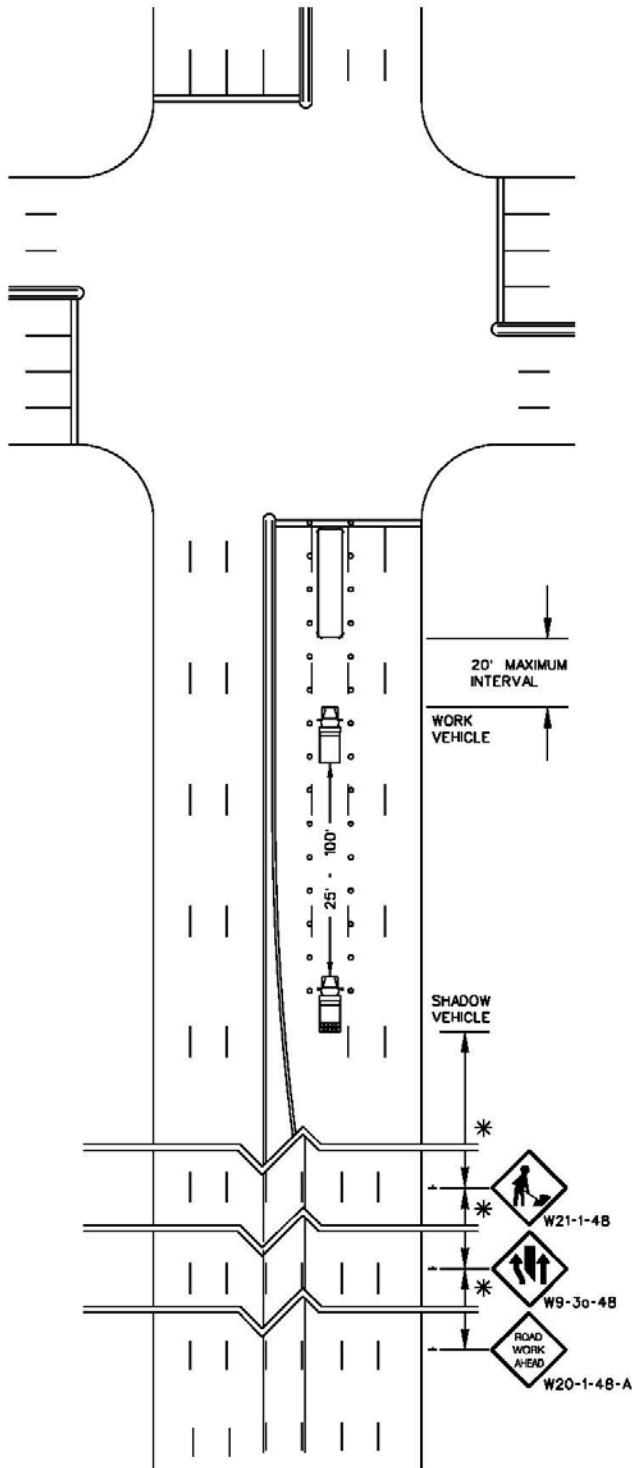

GENERAL NOTES:

1. THIS TRAFFIC CONTROL SETUP ILLUSTRATES AND SPECIFIES THE TRAFFIC CONTROL REQUIREMENTS FOR CONDUCTING TRAFFIC SIGNAL DETECTION LOOP INSTALLATION OPERATIONS, SPECIFICALLY STOP BAR LOOPS, WITHIN AN INTERIOR TRAVEL LANE OF A MULTILANE PRIMARY OR SECONDARY ROADWAY THAT REQUIRES THE PRESENCE OF PEDESTRIAN WORKERS AND EQUIPMENT WITHIN THE BOUNDARIES OF A TRAVEL LANE.
2. THE VEHICLE TRAIN SHALL INCLUDE THE WORK VEHICLE AND A SHADOW VEHICLE.
3. TRAFFIC CONTROL DEVICES SUCH AS STANDARD TRAFFIC CONES, 42" OVERSIZED TRAFFIC CONES OR PORTABLE PLASTIC DRUMS MAY BE USED FOR DELINEATION OF THE WORK AREA. WHEN UTILIZING THESE TRAFFIC CONTROL DEVICES, INSTALL AND MAINTAIN THESE TRAFFIC CONTROL DEVICES AS ILLUSTRATED.

VEHICLE TRAIN

WORK VEHICLE

AMBER COLORED HIGH INTENSITY ROTATING, FLASHING, OSCILLATING OR STROBE LIGHTS ARE REQUIRED ON THE WORK VEHICLE. VEHICLE HAZARD WARNING LIGHTS ARE ONLY PERMITTED AS A SUPPLEMENT TO THESE DEVICES.

OPERATE THE WORK VEHICLE NO MORE THAN 20' IN ADVANCE OF THE WORK ACTIVITY SITE.

SHADOW VEHICLE

AMBER COLORED HIGH INTENSITY ROTATING, FLASHING, OSCILLATING OR STROBE LIGHTS ARE REQUIRED ON THE SHADOW VEHICLE. VEHICLE HAZARD WARNING LIGHTS ARE ONLY PERMITTED AS A SUPPLEMENT TO THESE DEVICES.

A TRUCK MOUNTED ADVANCE WARNING ARROW PANEL IS REQUIRED ON THE SHADOW VEHICLE. OPERATE THE ADVANCE WARNING ARROW PANEL IN THE DOUBLE ARROW MODE WHEN TRAVEL LANES OPEN TO TRAFFIC ARE PRESENT ON EACH SIDE OF THE SHADOW VEHICLE.

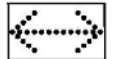

A TRUCK MOUNTED ATTENUATOR IS REQUIRED ON THE SHADOW VEHICLE. OPERATE THE SHADOW VEHICLE IN THE SAME TRAVEL LANE AS THE WORK VEHICLE. OPERATE THE SHADOW VEHICLE 25' TO 100' IN ADVANCE OF THE WORK VEHICLE.

TRAFFIC CONTROL DEVICE SPACING INTERVALS WORK ACTIVITY AREA	
SPEED LIMIT	SPACING INTERVALS
≤ 35 MPH	25 FEET
40 - 55 MPH	50 FEET

ADVANCE WARNING SIGN PLACEMENT INTERVALS			
SPEED LIMIT	*	*	*
URBAN / RURAL (LOW SPEED) ≤ 35 MPH	200 FT	200 FT	200 FT
URBAN / RURAL (INTERMEDIATE SPEED) 40 MPH - 50 MPH	350 FT	350 FT	350 FT
RURAL (HIGH SPEED) ≥ 50 MPH	500 FT	500 FT	500 FT

NOTE: THESE SIGN PLACEMENT INTERVALS ARE BASED UPON THE POSTED REGULATORY SPEED LIMIT OF THE ROADWAY PRIOR TO BEGINNING ANY WORK.

**TRAFFIC SIGNAL
WORK OPERATIONS
VEHICLE TRAIN
INTERIOR LANE CLOSURE
MULTILANE
PRIMARY & SECONDARY ROUTES
w/ 3 or MORE THROUGH LANES
CONNECTING THE STOP BAR LOOP
TO THE PULL BOX**

1. This traffic control setup specifies the traffic control requirements for connecting the stop bar loop within an interior travel lane of a multilane primary or secondary roadway to the pull box in the adjacent shoulder. The saw cut and wire installation operations require the presence of pedestrian workers and equipment within the boundaries of a travel lane.
2. Avoid conducting these work activities during high traffic volume peak periods when possible.
3. The vehicle train that operated in the travel lanes during the stop bar loop installation operations is not required during the saw cut and wire installation operations, however, the vehicle train may remain in place during the saw cut and wire installation operations to provide a secure area for the pedestrian workers to retreat to in the event of an errant vehicle. Maintain the advance warning signs relative to the vehicle train if the vehicle train is maintained in place.
4. If traffic control devices are used to supplement the vehicle train and delineate the work area during installation of the stop bar loop, maintain these devices in place when the vehicle train remains during the saw cut and wire installation operations. If the vehicle train is discontinued and removed during the saw cut and wire installation operations, also remove the traffic control devices.
5. Prior to beginning the saw cut and wire installation operations, stop traffic in all travel lanes approaching the work area.
6. Requirements for a temporary cessation of traffic flow are as follows:

A temporary cessation of traffic flow is permissible during non-peak traffic periods, as directed by the District Traffic Engineer, to conduct saw cut and wire installation operations to connect a stop bar loop within an interior travel lane of a multilane primary or secondary roadway to the pull box in the adjacent shoulder. The temporary cessation of traffic flow shall not exceed 3 minutes. The temporary cessation of traffic flow shall apply to all travel lanes in the same direction. Utilize flaggers, properly equipped with stop/slow paddles, to stop the traffic flow. No less than one (1) flagger is required for each travel lane occupied by traffic intended to be stopped. The flaggers should enter the roadway during a gap in the traffic flow to permit motorists sufficient space to come to a safe stop. Immediately prior to completion of the 3 minute time interval, all workers shall remove equipment relative to the saw cut and wire installation operations and vacate the travel lanes to permit the flaggers to release the stopped traffic. When the vehicle train is maintained, the vehicle train may remain in place when the stopped traffic in the adjacent travel lanes is released. Allow all stopped traffic to clear the work site prior to stopping traffic again.

Daytime Operations –

Utilize and install “Be Prepared To Stop” signs (W3-4-48), one on each shoulder, in advance of the location of the flaggers. Utilize the table, “Advance Warning Sign Placement Intervals” as a guide for a minimum distance for placement of the “Be Prepared To Stop” signs. Depending upon the traffic volumes, greater distances may be required to ensure the “Be Prepared To Stop” signs are in advance of any traffic queues that may develop.

Nighttime Operations –

Illuminate the flagger locations. All flaggers shall wear Class 3 High Visibility safety apparel that meet the ANSI/ISEA 107 requirements and a fluorescent hardhat. Utilize a changeable message sign displaying the message, “Prepare To Stop”, at a minimum character height of 18 inches. Place the changeable message sign at a location in advance of the anticipated traffic queues.

DRAWING 606-05-B
 TRAFFIC SIGNAL
 WORK OPERATIONS
 VEHICLE TRAIN
 INTERIOR LANE CLOSURE
 MULTILANE
 PRIMARY & SECONDARY
 ROUTES w/
 3 OR MORE THROUGH LANES
 CONNECTING THE STOP BAR LOOP
 TO THE PULL BOX

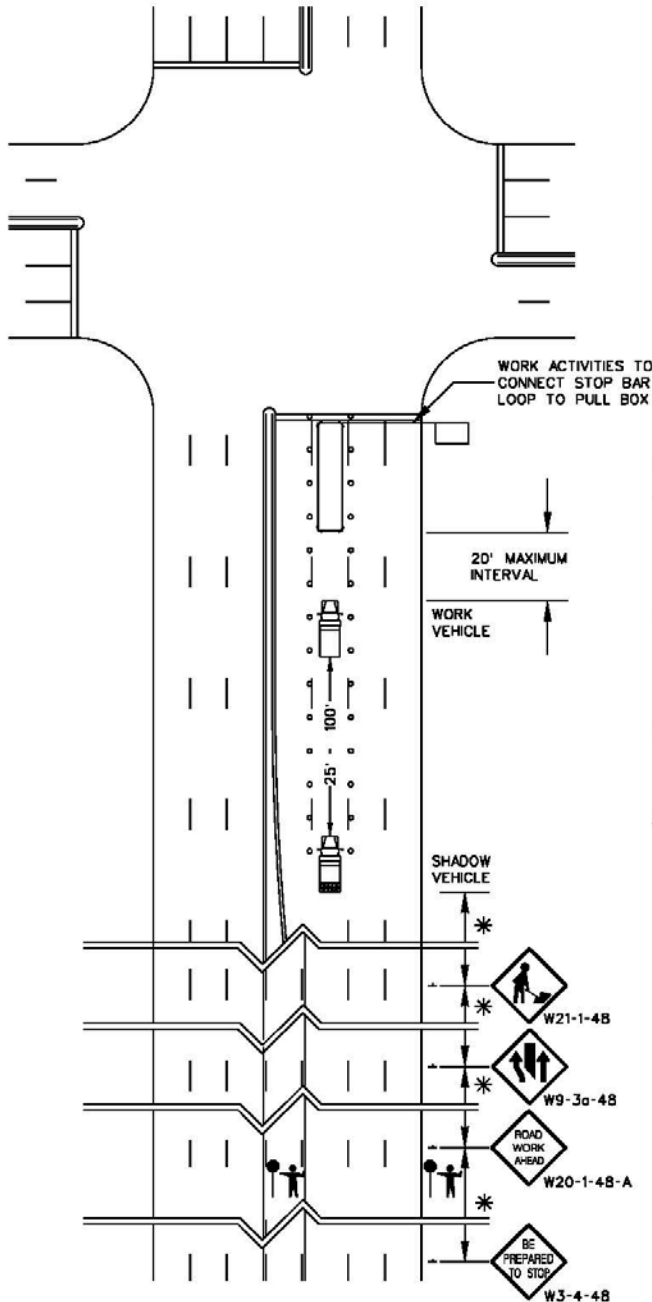

GENERAL NOTES:

1. THIS TRAFFIC CONTROL SETUP ILLUSTRATES AND SPECIFIES THE TRAFFIC CONTROL REQUIREMENTS FOR CONNECTING THE STOP BAR LOOP WITHIN AN INTERIOR TRAVEL LANE OF A MULTILANE PRIMARY OR SECONDARY ROADWAY TO THE PULL BOX IN THE ADJACENT SHOULDER. THE SAW CUT AND WIRE INSTALLATION OPERATIONS REQUIRE THE PRESENCE OF PEDESTRIAN WORKERS AND EQUIPMENT WITHIN THE BOUNDARIES OF A TRAVEL LANE.
2. THE VEHICLE TRAIN THAT OPERATED IN THE TRAVEL LANES DURING THE STOP BAR LOOP INSTALLATION OPERATIONS IS NOT REQUIRED DURING THE SAW CUT AND WIRE INSTALLATION OPERATIONS, HOWEVER, THE VEHICLE TRAIN MAY REMAIN IN PLACE TO PROVIDE A SECURE AREA FOR THE PEDESTRIAN WORKERS TO RETREAT TO IN THE EVENT OF AN ERRANT VEHICLE. MAINTAIN THE ADVANCE WARNING SIGNS RELATIVE TO THE VEHICLE TRAIN IF THE VEHICLE TRAIN IS MAINTAINED IN PLACE.
3. IF TRAFFIC CONTROL DEVICES ARE USED TO SUPPLEMENT THE VEHICLE TRAIN AND DELINEATE THE ORIGINAL WORK AREA, MAINTAIN THESE DEVICES IN PLACE WHEN THE VEHICLE TRAIN REMAINS DURING THE SAW CUT AND WIRE INSTALLATION OPERATIONS. IF THE VEHICLE TRAIN IS DISCONTINUED AND REMOVED DURING THE SAW CUT AND WIRE INSTALLATION OPERATIONS, ALSO REMOVE THE TRAFFIC CONTROL DEVICES.
4. PRIOR TO BEGINNING THE SAW CUT AND WIRE INSTALLATION OPERATIONS, STOP TRAFFIC IN ALL TRAVEL LANES APPROACHING THE WORK AREA AS DIRECTED BY THE "REQUIREMENTS FOR A TEMPORARY CESSATION OF TRAFFIC FLOW".

ADVANCE WARNING SIGN PLACEMENT INTERVALS			
SPEED LIMIT	*	*	*
URBAN / RURAL (LOW SPEED) ≤ 35 MPH	200 FT	200 FT	200 FT
URBAN / RURAL (INTERMEDIATE SPEED) 40 MPH - 50 MPH	350 FT	350 FT	350 FT
RURAL (HIGH SPEED) ≥ 50 MPH	500 FT	500 FT	500 FT

NOTE: THESE SIGN PLACEMENT INTERVALS ARE BASED UPON THE POSTED REGULATORY SPEED LIMIT OF THE ROADWAY PRIOR TO BEGINNING ANY WORK.

REQUIREMENTS FOR A TEMPORARY CESSATION OF TRAFFIC FLOW

A TEMPORARY CESSATION OF TRAFFIC FLOW IS PERMISSIBLE DURING NON-PEAK TRAFFIC PERIODS, AS DIRECTED BY THE DISTRICT TRAFFIC ENGINEER, TO CONDUCT SAW CUT AND WIRE INSTALLATION OPERATIONS TO CONNECT A STOP BAR LOOP WITHIN AN INTERIOR TRAVEL LANE OF A MULTILANE PRIMARY OR SECONDARY ROADWAY TO THE PULL BOX IN THE ADJACENT SHOULDER. THE TEMPORARY CESSATION OF TRAFFIC FLOW SHALL NOT EXCEED A DURATION OF 3 MINUTES. THE TEMPORARY CESSATION OF TRAFFIC FLOW SHALL APPLY TO ALL TRAVEL LANES IN THE SAME DIRECTION. UTILIZE FLAGGERS, PROPERLY EQUIPPED WITH STOP/SLOW PADDLES, TO STOP THE TRAFFIC FLOW. NO LESS THAN ONE (1) FLAGGER IS REQUIRED FOR EACH TRAVEL LANE OCCUPIED BY TRAFFIC INTENDED TO BE STOPPED. THE FLAGGERS SHOULD ENTER THE ROADWAY DURING A GAP IN THE TRAFFIC FLOW TO PERMIT MOTORISTS SUFFICIENT SPACE TO COME TO A SAFE STOP. IMMEDIATELY PRIOR TO COMPLETION OF THE 3 MINUTE TIME INTERVAL, ALL WORKERS SHALL REMOVE EQUIPMENT RELATIVE TO THE SAW CUT AND WIRE INSTALLATION OPERATIONS AND VACATE THE TRAVEL LANES TO PERMIT THE FLAGGERS TO RELEASE THE STOPPED TRAFFIC. WHEN THE VEHICLE TRAIN IS MAINTAINED, THE VEHICLE TRAIN MAY REMAIN IN PLACE WHEN THE STOPPED TRAFFIC IN THE ADJACENT TRAVEL LANES IS RELEASED. ALLOW ALL STOPPED TRAFFIC TO CLEAR THE WORK SITE PRIOR TO STOPPING TRAFFIC AGAIN.

DAYTIME OPERATIONS -

UTILIZE AND INSTALL "BE PREPARED TO STOP" SIGNS (W3-4-4B), ONE ON EACH SHOULDER, IN ADVANCE OF THE LOCATION OF THE FLAGGERS. UTILIZE THE TABLE, "ADVANCE WARNING SIGN PLACEMENT INTERVALS" AS A GUIDE FOR A MINIMUM DISTANCE FOR PLACEMENT OF THE "BE PREPARED TO STOP" SIGNS. DEPENDING UPON TRAFFIC VOLUMES, GREATER DISTANCES MAY BE REQUIRED TO ENSURE THE "BE PREPARED TO STOP" SIGNS ARE IN ADVANCE OF THE TRAFFIC QUEUES.

NIGHTTIME OPERATIONS -

ILLUMINATE THE FLAGGER LOCATIONS. ALL FLAGGERS SHALL WEAR CLASS 3 HIGH VISIBILITY SAFETY APPAREL THAT MEET THE ANSI/ISEA 107 REQUIREMENTS AND A FLUORESCENT HARDHAT. UTILIZE A CHANGEABLE MESSAGE SIGN DISPLAYING THE MESSAGE, "PREPARE TO STOP", AT A MINIMUM CHARACTER HEIGHT OF 18 INCHES. PLACE THE CHANGEABLE MESSAGE SIGN AT A LOCATION IN ADVANCE OF THE ANTICIPATED TRAFFIC QUEUES.

**TRAFFIC SIGNAL
WORK OPERATIONS
VEHICLE TRAIN
RIGHT LANE CLOSURE
MULTILANE
PRIMARY & SECONDARY ROUTES
w/ 2 THROUGH LANES
TRAFFIC SIGNAL DETECTION LOOP INSTALLATION
SET BACK LOOPS**

1. This traffic control setup specifies the traffic control requirements for conducting traffic signal detection loop installation operations, specifically set back loops, from the right travel lane of a multilane primary or secondary roadway with two through lanes. This traffic control setup requires a work vehicle and a shadow vehicle.
2. Avoid conducting traffic signal detection loop installation operations or similar work activities that interfere with or create disruptions to normal traffic operations during high traffic volume peak periods when possible.
3. A vehicle train shall operate in the right travel lane. Conduct the traffic signal set back detection loop installation operations from the right travel lane.
4. Operate the work vehicle no more than 20' beyond the work activity site.
5. A shadow vehicle is required in the vehicle train.
A truck mounted advance warning arrow panel displaying a flashing arrow is required on the shadow vehicle.
A truck mounted attenuator is required on the shadow vehicle.
Operate the shadow vehicle in the same travel lane as the work vehicle. Operate the shadow vehicle 25' to 100' in advance of the work vehicle.
6. Supplement the work vehicle and the shadow vehicle with amber colored auxiliary warning lights. The auxiliary warning lights shall be high intensity rotating, flashing, oscillating or strobe lights. Standard vehicle hazard warning lights are only permitted as a supplement to the auxiliary warning lights.
7. Requirements for a temporary cessation of traffic flow are as follows:

A temporary cessation of traffic flow is permissible during non-peak traffic periods, as directed by the District Traffic Engineer, to conduct saw cut and wire installation operations to connect a stop bar loop within an interior travel lane of a multilane primary or secondary roadway to the pull box in the adjacent shoulder. The temporary cessation of traffic flow shall not exceed 3 minutes. The temporary cessation of traffic flow shall apply to all travel lanes in the same direction. Utilize flaggers, properly equipped with stop/slow paddles, to stop the traffic flow. No less than one (1) flagger is required for each travel lane occupied by traffic intended to be stopped. The flaggers should enter the roadway during a gap in the traffic flow to permit motorists sufficient space to come to a safe stop. Immediately prior to completion of the 3 minute time interval, all workers shall remove equipment relative to the saw cut and wire installation operations and vacate the travel lanes to permit the flaggers to release the stopped traffic. When the vehicle train is maintained, the vehicle train may remain in place when the stopped traffic in the adjacent travel lanes is released. Allow all stopped traffic to clear the work site prior to stopping traffic again.

Daytime Operations –

Utilize and install “Be Prepared To Stop” signs (W3-4-48), one on each shoulder, in advance of the location of the flaggers. Utilize the table, “Advance Warning Sign Placement Intervals” as a guide for a minimum distance for placement of the “Be Prepared To Stop” signs. Depending upon the traffic volumes, greater distances may be required to ensure the “Be Prepared To Stop” signs are in advance of any traffic queues that may develop.

Nighttime Operations –

Illuminate the flagger locations. All flaggers shall wear Class 3 High Visibility safety apparel that meet the ANSI/ISEA 107 requirements and a fluorescent hardhat. Utilize a changeable message sign displaying the message, “Prepare To Stop”, at a minimum character height of 18 inches. Place the changeable message sign at a location in advance of the anticipated traffic queues.

ADVANCE WARNING SIGN PLACEMENT INTERVALS			
SPEED LIMIT	*	*	*
URBAN / RURAL (LOW SPEED) ≤ 35 MPH	200 FT	200 FT	200 FT
URBAN / RURAL (INTERMEDIATE SPEED) 40 MPH - 50 MPH	350 FT	350 FT	350 FT
RURAL (HIGH SPEED) ≥ 50 MPH	500 FT	500 FT	500 FT

NOTE: THESE SIGN PLACEMENT INTERVALS ARE BASED UPON THE POSTED REGULATORY SPEED LIMIT OF THE ROADWAY PRIOR TO BEGINNING ANY WORK.

TRAFFIC CONTROL DEVICE SPACING INTERVALS WORK ACTIVITY AREA	
SPEED LIMIT	SPACING INTERVALS
≤ 35 MPH	25 FEET
40 - 55 MPH	50 FEET

DRAWING 606-06
 TRAFFIC SIGNAL
 WORK OPERATIONS
 VEHICLE TRAIN
 RIGHT LANE CLOSURE
 MULTILANE
 PRIMARY & SECONDARY
 ROUTES w/
 2 THROUGH LANES
 TRAFFIC SIGNAL DETECTION LOOP
 INSTALLATION
 SET BACK LOOPS

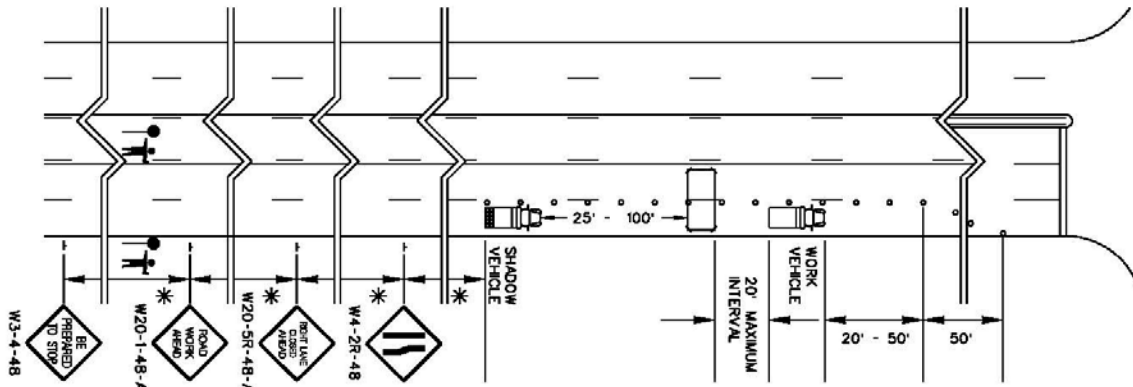

VEHICLE TRAIN

GENERAL NOTES:

1. THIS TRAFFIC CONTROL SETUP ILLUSTRATES AND SPECIFIES THE TRAFFIC CONTROL REQUIREMENTS FOR CONDUCTING TRAFFIC SIGNAL DETECTION LOOP INSTALLATION OPERATIONS, SPECIFICALLY SET BACK LOOPS, FROM THE RIGHT TRAVEL LANE OF A MULTILANE PRIMARY OR SECONDARY ROADWAY THAT REQUIRES THE PRESENCE OF PEDESTRIAN WORKERS AND EQUIPMENT WITHIN THE BOUNDARIES OF A TRAVEL LANE.
2. THE VEHICLE TRAIN SHALL INCLUDE THE WORK VEHICLE AND A SHADOW VEHICLE. UTILIZE THE VEHICLE TRAIN TO PROVIDE A SECURE AREA FOR THE PEDESTRIAN WORKERS TO RETREAT TO BETWEEN MULTIPLE TRAFFIC CESSATIONS OR IN THE EVENT OF AN ERRANT VEHICLE.
3. TRAFFIC CONTROL DEVICES SUCH AS STANDARD TRAFFIC CONES, 42" OVERSIZED TRAFFIC CONES OR PORTABLE PLASTIC DRUMS MAY BE USED FOR DELINEATION OF THE WORK AREA. WHEN UTILIZING THESE TRAFFIC CONTROL DEVICES, INSTALL AND MAINTAIN THESE TRAFFIC CONTROL DEVICES AS ILLUSTRATED.
4. PRIOR TO BEGINNING THE SAW CUT AND WIRE INSTALLATION OPERATIONS, STOP TRAFFIC IN ALL TRAVEL LANES APPROACHING THE WORK AREA AS DIRECTED BY THE "REQUIREMENTS FOR A TEMPORARY CESSATION OF TRAFFIC FLOW".

WORK VEHICLE

AMBER COLORED HIGH INTENSITY ROTATING, FLASHING, OSCILLATING OR STROBE LIGHTS ARE REQUIRED ON THE WORK VEHICLE. VEHICLE HAZARD WARNING LIGHTS ARE ONLY PERMITTED AS A SUPPLEMENT TO THESE DEVICES.
 OPERATE THE WORK VEHICLE NO MORE THAN 20' IN ADVANCE OF THE WORK ACTIVITY SITE.

SHADOW VEHICLE

AMBER COLORED HIGH INTENSITY ROTATING, FLASHING, OSCILLATING OR STROBE LIGHTS ARE REQUIRED ON THE SHADOW VEHICLE. VEHICLE HAZARD WARNING LIGHTS ARE ONLY PERMITTED AS A SUPPLEMENT TO THESE DEVICES.

A TRUCK MOUNTED ADVANCE WARNING ARROW PANEL DISPLAYING A FLASHING ARROW IS REQUIRED ON THE SHADOW VEHICLE.

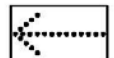

A TRUCK MOUNTED ATTENUATOR IS REQUIRED ON THE SHADOW VEHICLE.

OPERATE THE SHADOW VEHICLE IN THE SAME TRAVEL LANE AS THE WORK VEHICLE. OPERATE THE SHADOW VEHICLE 25' TO 100' IN ADVANCE OF THE WORK VEHICLE.

REQUIREMENTS FOR A TEMPORARY CESSATION OF TRAFFIC FLOW

A TEMPORARY CESSATION OF TRAFFIC FLOW IS PERMISSIBLE DURING NON-PEAK TRAFFIC PERIODS, AS DIRECTED BY THE DISTRICT TRAFFIC ENGINEER, TO CONDUCT SAW CUT AND WIRE INSTALLATION OPERATIONS TO CONNECT A STOP BAR LOOP WITHIN AN INTERIOR TRAVEL LANE OF A MULTILANE PRIMARY OR SECONDARY ROADWAY TO THE PULL BOX IN THE ADJACENT SHOULDER. THE TEMPORARY CESSATION OF TRAFFIC FLOW SHALL NOT EXCEED A DURATION OF 3 MINUTES. THE TEMPORARY CESSATION OF TRAFFIC FLOW SHALL APPLY TO ALL TRAVEL LANES IN THE SAME DIRECTION. UTILIZE FLAGGERS, PROPERLY EQUIPPED WITH STOP/SLOW PADDLES, TO STOP THE TRAFFIC FLOW. NO LESS THAN ONE (1) FLAGGER IS REQUIRED FOR EACH TRAVEL LANE OCCUPIED BY TRAFFIC INTENDED TO BE STOPPED. THE FLAGGERS SHOULD ENTER THE ROADWAY DURING A GAP IN THE TRAFFIC FLOW TO PERMIT MOTORISTS SUFFICIENT SPACE TO COME TO A SAFE STOP. IMMEDIATELY PRIOR TO COMPLETION OF THE 3 MINUTE TIME INTERVAL, ALL WORKERS SHALL REMOVE EQUIPMENT RELATIVE TO THE SAW CUT AND WIRE INSTALLATION OPERATIONS AND VACATE THE TRAVEL LANES TO PERMIT THE FLAGGERS TO RELEASE THE STOPPED TRAFFIC. WHEN THE VEHICLE TRAIN IS MAINTAINED, THE VEHICLE TRAIN MAY REMAIN IN PLACE WHEN THE STOPPED TRAFFIC IN THE ADJACENT TRAVEL LANES IS RELEASED. ALLOW ALL STOPPED TRAFFIC TO CLEAR THE WORK SITE PRIOR TO STOPPING TRAFFIC AGAIN.

DAYTIME OPERATIONS -

UTILIZE AND INSTALL "BE PREPARED TO STOP" SIGNS (W3-4-4B), ONE ON EACH SHOULDER, IN ADVANCE OF THE LOCATION OF THE FLAGGERS. UTILIZE THE TABLE, "ADVANCE WARNING SIGN PLACEMENT INTERVALS" AS A GUIDE FOR A MINIMUM DISTANCE FOR PLACEMENT OF THE "BE PREPARED TO STOP" SIGNS. DEPENDING UPON TRAFFIC VOLUMES, GREATER DISTANCES MAY BE REQUIRED TO ENSURE THE "BE PREPARED TO STOP" SIGNS ARE IN ADVANCE OF THE TRAFFIC QUEUES.

NIGHTTIME OPERATIONS -

ILLUMINATE THE FLAGGER LOCATIONS. ALL FLAGGERS SHALL WEAR CLASS 3 HIGH VISIBILITY SAFETY APPAREL THAT MEET THE ANSI/ISEA 107 REQUIREMENTS AND A FLUORESCENT HARDHAT. UTILIZE A CHANGEABLE MESSAGE SIGN DISPLAYING THE MESSAGE, "PREPARE TO STOP", AT A MINIMUM CHARACTER HEIGHT OF 18 INCHES. PLACE THE CHANGEABLE MESSAGE SIGN AT A LOCATION IN ADVANCE OF THE ANTICIPATED TRAFFIC QUEUES.

**TRAFFIC SIGNAL
WORK OPERATIONS
VEHICLE TRAIN
RIGHT LANE CLOSURE
MULTILANE
PRIMARY & SECONDARY ROUTES
w/ 3 OR MORE THROUGH LANES
TRAFFIC SIGNAL DETECTION LOOP INSTALLATION
SET BACK LOOPS**

1. This traffic control setup specifies the traffic control requirements for conducting traffic signal detection loop installation operations, specifically set back loops, from the right travel lane of a multilane primary or secondary roadway with three or more through lanes. This traffic control setup requires a work vehicle and a shadow vehicle.
2. Avoid conducting traffic signal detection loop installation operations or similar work activities that interfere with or create disruptions to normal traffic operations during high traffic volume peak periods when possible.
3. A vehicle train shall operate in the right travel lane. Conduct the traffic signal set back detection loop installation operations from the right travel lane.
4. Operate the work vehicle no more than 20' beyond the work activity site.
5. A shadow vehicle is required in the vehicle train.
A truck mounted advance warning arrow panel displaying a flashing arrow is required on the shadow vehicle.
A truck mounted attenuator is required on the shadow vehicle.
Operate the shadow vehicle in the same travel lane as the work vehicle. Operate the shadow vehicle 25' to 100' in advance of the work vehicle.
6. Supplement the work vehicle and the shadow vehicle with amber colored auxiliary warning lights. The auxiliary warning lights shall be high intensity rotating, flashing, oscillating or strobe lights. Standard vehicle hazard warning lights are only permitted as a supplement to the auxiliary warning lights.
7. Requirements for a temporary cessation of traffic flow are as follows:

A temporary cessation of traffic flow is permissible during non-peak traffic periods, as directed by the District Traffic Engineer, to conduct saw cut and wire installation operations to connect a stop bar loop within an interior travel lane of a multilane primary or secondary roadway to the pull box in the adjacent shoulder. The temporary cessation of traffic flow shall not exceed 3 minutes. The temporary cessation of traffic flow shall apply to all travel lanes in the same direction. Utilize flaggers, properly equipped with stop/slow paddles, to stop the traffic flow. No less than one (1) flagger is required for each travel lane occupied by traffic intended to be stopped. The flaggers should enter the roadway during a gap in the traffic flow to permit motorists sufficient space to come to a safe stop. Immediately prior to completion of the 3 minute time interval, all workers shall remove equipment relative to the saw cut and wire installation operations and vacate the travel lanes to permit the flaggers to release the stopped traffic. When the vehicle train is maintained, the vehicle train may remain in place when the stopped traffic in the adjacent travel lanes is released. Allow all stopped traffic to clear the work site prior to stopping traffic again.

Daytime Operations –

Utilize and install “Be Prepared To Stop” signs (W3-4-48), one on each shoulder, in advance of the location of the flaggers. Utilize the table, “Advance Warning Sign Placement Intervals” as a guide for a minimum distance for placement of the “Be Prepared To Stop” signs. Depending upon the traffic volumes, greater distances may be required to ensure the “Be Prepared To Stop” signs are in advance of any traffic queues that may develop.

Nighttime Operations –

Illuminate the flagger locations. All flaggers shall wear Class 3 High Visibility safety apparel that meet the ANSI/ISEA 107 requirements and a fluorescent hardhat. Utilize a changeable message sign displaying the message, “Prepare To Stop”, at a minimum character height of 18 inches. Place the changeable message sign at a location in advance of the anticipated traffic queues.

ADVANCE WARNING SIGN PLACEMENT INTERVALS			
SPEED LIMIT	*	*	*
URBAN / RURAL (LOW SPEED) ≤ 35 MPH	200 FT	200 FT	200 FT
URBAN / RURAL (INTERMEDIATE SPEED) 40 MPH - 50 MPH	350 FT	350 FT	350 FT
RURAL (HIGH SPEED) ≥ 50 MPH	500 FT	500 FT	500 FT

TRAFFIC CONTROL DEVICE SPACING INTERVALS WORK ACTIVITY AREA	
SPEED LIMIT	SPACING INTERVALS
≤ 35 MPH	25 FEET
40 - 55 MPH	50 FEET

NOTE: THESE SIGN PLACEMENT INTERVALS ARE BASED UPON THE POSTED REGULATORY SPEED LIMIT OF THE ROADWAY PRIOR TO BEGINNING ANY WORK.

DRAWING 606-07
 TRAFFIC SIGNAL
 WORK OPERATIONS
 VEHICLE TRAIN
 RIGHT LANE CLOSURE
 MULTILANE
 PRIMARY & SECONDARY
 ROUTES w/
 3 OR MORE THROUGH LANES
 TRAFFIC SIGNAL DETECTION LOOP
 INSTALLATION
 SET BACK LOOPS

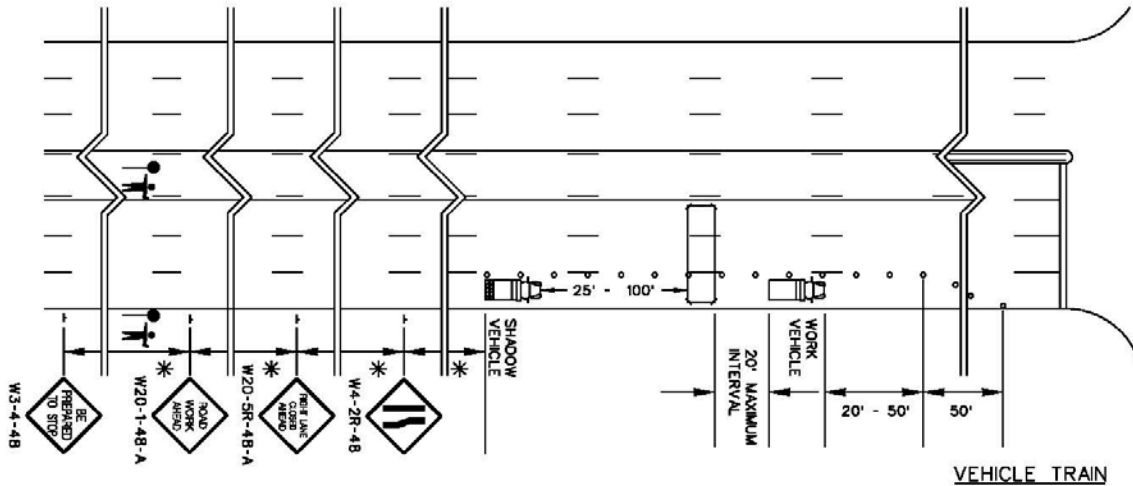

GENERAL NOTES:

1. THIS TRAFFIC CONTROL SETUP ILLUSTRATES AND SPECIFIES THE TRAFFIC CONTROL REQUIREMENTS FOR CONDUCTING TRAFFIC SIGNAL DETECTION LOOP INSTALLATION OPERATIONS, SPECIFICALLY SET BACK LOOPS, FROM THE RIGHT TRAVEL LANE OF A MULTILANE PRIMARY OR SECONDARY ROADWAY THAT REQUIRES THE PRESENCE OF PEDESTRIAN WORKERS AND EQUIPMENT WITHIN THE BOUNDARIES OF A TRAVEL LANE.
2. THE VEHICLE TRAIN SHALL INCLUDE THE WORK VEHICLE AND A SHADOW VEHICLE. UTILIZE THE VEHICLE TRAIN TO PROVIDE A SECURE AREA FOR THE PEDESTRIAN WORKERS TO RETREAT TO BETWEEN MULTIPLE TRAFFIC CESSATIONS OR IN THE EVENT OF AN ERRANT VEHICLE.
3. TRAFFIC CONTROL DEVICES SUCH AS STANDARD TRAFFIC CONES, 42" OVERSIZED TRAFFIC CONES OR PORTABLE PLASTIC DRUMS MAY BE USED FOR DELINEATION OF THE WORK AREA. WHEN UTILIZING THESE TRAFFIC CONTROL DEVICES, INSTALL AND MAINTAIN THESE TRAFFIC CONTROL DEVICES AS ILLUSTRATED.
4. PRIOR TO BEGINNING THE SAW CUT AND WIRE INSTALLATION OPERATIONS, STOP TRAFFIC IN ALL TRAVEL LANES APPROACHING THE WORK AREA AS DIRECTED BY THE "REQUIREMENTS FOR A TEMPORARY CESSATION OF TRAFFIC FLOW".

WORK VEHICLE

AMBER COLORED HIGH INTENSITY ROTATING, FLASHING, OSCILLATING OR STROBE LIGHTS ARE REQUIRED ON THE WORK VEHICLE. VEHICLE HAZARD WARNING LIGHTS ARE ONLY PERMITTED AS A SUPPLEMENT TO THESE DEVICES.
 OPERATE THE WORK VEHICLE NO MORE THAN 20' IN ADVANCE OF THE WORK ACTIVITY SITE.

SHADOW VEHICLE

AMBER COLORED HIGH INTENSITY ROTATING, FLASHING, OSCILLATING OR STROBE LIGHTS ARE REQUIRED ON THE SHADOW VEHICLE. VEHICLE HAZARD WARNING LIGHTS ARE ONLY PERMITTED AS A SUPPLEMENT TO THESE DEVICES.

A TRUCK MOUNTED ADVANCE WARNING ARROW PANEL DISPLAYING A FLASHING ARROW IS REQUIRED ON THE SHADOW VEHICLE.

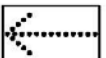

A TRUCK MOUNTED ATTENUATOR IS REQUIRED ON THE SHADOW VEHICLE.

OPERATE THE SHADOW VEHICLE IN THE SAME TRAVEL LANE AS THE WORK VEHICLE. OPERATE THE SHADOW VEHICLE 25' TO 100' IN ADVANCE OF THE WORK VEHICLE.

REQUIREMENTS FOR A TEMPORARY CESSATION OF TRAFFIC FLOW

A TEMPORARY CESSATION OF TRAFFIC FLOW IS PERMISSIBLE DURING NON-PEAK TRAFFIC PERIODS, AS DIRECTED BY THE DISTRICT TRAFFIC ENGINEER, TO CONDUCT SAW CUT AND WIRE INSTALLATION OPERATIONS TO CONNECT A STOP BAR LOOP WITHIN AN INTERIOR TRAVEL LANE OF A MULTILANE PRIMARY OR SECONDARY ROADWAY TO THE PULL BOX IN THE ADJACENT SHOULDER. THE TEMPORARY CESSATION OF TRAFFIC FLOW SHALL NOT EXCEED A DURATION OF 3 MINUTES. THE TEMPORARY CESSATION OF TRAFFIC FLOW SHALL APPLY TO ALL TRAVEL LANES IN THE SAME DIRECTION. UTILIZE FLAGGERS, PROPERLY EQUIPPED WITH STOP/SLOW PADDLES, TO STOP THE TRAFFIC FLOW. NO LESS THAN ONE (1) FLAGGER IS REQUIRED FOR EACH TRAVEL LANE OCCUPIED BY TRAFFIC INTENDED TO BE STOPPED. THE FLAGGERS SHOULD ENTER THE ROADWAY DURING A GAP IN THE TRAFFIC FLOW TO PERMIT MOTORISTS SUFFICIENT SPACE TO COME TO A SAFE STOP. IMMEDIATELY PRIOR TO COMPLETION OF THE 3 MINUTE TIME INTERVAL, ALL WORKERS SHALL REMOVE EQUIPMENT RELATIVE TO THE SAW CUT AND WIRE INSTALLATION OPERATIONS AND VACATE THE TRAVEL LANES TO PERMIT THE FLAGGERS TO RELEASE THE STOPPED TRAFFIC. WHEN THE VEHICLE TRAIN IS MAINTAINED, THE VEHICLE TRAIN MAY REMAIN IN PLACE WHEN THE STOPPED TRAFFIC IN THE ADJACENT TRAVEL LANES IS RELEASED. ALLOW ALL STOPPED TRAFFIC TO CLEAR THE WORK SITE PRIOR TO STOPPING TRAFFIC AGAIN.

DAYTIME OPERATIONS -

UTILIZE AND INSTALL "BE PREPARED TO STOP" SIGNS (W3-4-4B), ONE ON EACH SHOULDER, IN ADVANCE OF THE LOCATION OF THE FLAGGERS. UTILIZE THE TABLE, "ADVANCE WARNING SIGN PLACEMENT INTERVALS" AS A GUIDE FOR A MINIMUM DISTANCE FOR PLACEMENT OF THE "BE PREPARED TO STOP" SIGNS. DEPENDING UPON TRAFFIC VOLUMES, GREATER DISTANCES MAY BE REQUIRED TO ENSURE THE "BE PREPARED TO STOP" SIGNS ARE IN ADVANCE OF THE TRAFFIC QUEUES.

NIGHTTIME OPERATIONS -

ILLUMINATE THE FLAGGER LOCATIONS. ALL FLAGGERS SHALL WEAR CLASS 3 HIGH VISIBILITY SAFETY APPAREL THAT MEET THE ANSI/ISEA 107 REQUIREMENTS AND A FLUORESCENT HARDHAT. UTILIZE A CHANGEABLE MESSAGE SIGN DISPLAYING THE MESSAGE, "PREPARE TO STOP", AT A MINIMUM CHARACTER HEIGHT OF 18 INCHES. PLACE THE CHANGEABLE MESSAGE SIGN AT A LOCATION IN ADVANCE OF THE ANTICIPATED TRAFFIC QUEUES.

***PAVEMENT MARKING APPLICATION
OPERATIONS***

STANDARD DRAWING NO. 610-01

Through

STANDARD DRAWING NO. 610-04

**PAVEMENT MARKING APPLICATION
INTERSECTIONS
VEHICLE TRAIN
TWO-LANE TWO-WAY ROADWAY
PRIMARY & SECONDARY ROUTES**

1. This traffic control setup specifies the traffic control requirements for applying pavement markings within the approach to an intersection on a two-lane two-way roadway. This traffic control setup requires a work vehicle, a shadow vehicle and multiple flagger flagging operations on all approaches to the intersection. A secondary work vehicle is optional.
2. Avoid conducting pavement marking application operations or similar work activities that interfere with or create disruptions to normal traffic operations during high traffic volume peak periods when possible.
3. Install multiple flagger flagging operations on all approaches to the intersection. Install a multiple flagger flagging operation, including all traffic control devices necessary to a flagging operation, in the roadway where the vehicle train is operating. Only flaggers and advance warning signs are required on the approaches intersecting the roadway the vehicle train is operating in. Traffic control devices are not required on the intersecting roadway approaches.
4. The vehicle train shall include the primary work vehicle and a shadow vehicle. Supplement the shadow vehicle with a truck mounted advance warning arrow panel operating in the "Four Corner" Caution Mode with one lamp in each corner. A truck mounted attenuator is optional on the shadow vehicle. A secondary work vehicle is an optional addition to the vehicle train. When a secondary work vehicle is used, supplement the secondary work vehicle with a truck mounted advance warning arrow panel operating in the "Four Corner" Caution Mode with one lamp in each corner. A truck mounted attenuator is optional on a secondary work vehicle.
 - Operate the work vehicle no more than 20' in advance of the work activity site.
 - Operate the secondary work vehicle no more than 50' in advance of the primary work vehicle.
 - Operate the shadow vehicle 25' to 100' in advance of the primary work vehicle when no secondary work vehicle is utilized. When a secondary vehicle is used, operate the shadow vehicle 25' to 100' in advance of the secondary work vehicle.
5. Maintain two-way radio communications between all flaggers.
6. Supplement the work vehicles and the shadow vehicles with amber colored auxiliary warning lights. The auxiliary warning lights shall be high intensity rotating, flashing, oscillating or strobe lights. Standard vehicle hazard warning lights are only permitted as a supplement to the auxiliary warning lights.

DRAWING 610-01 PAVEMENT MARKING APPLICATION INTERSECTIONS VEHICLE TRAIN TWO-LANE TWO-WAY ROADWAY PRIMARY & SECONDARY ROUTES

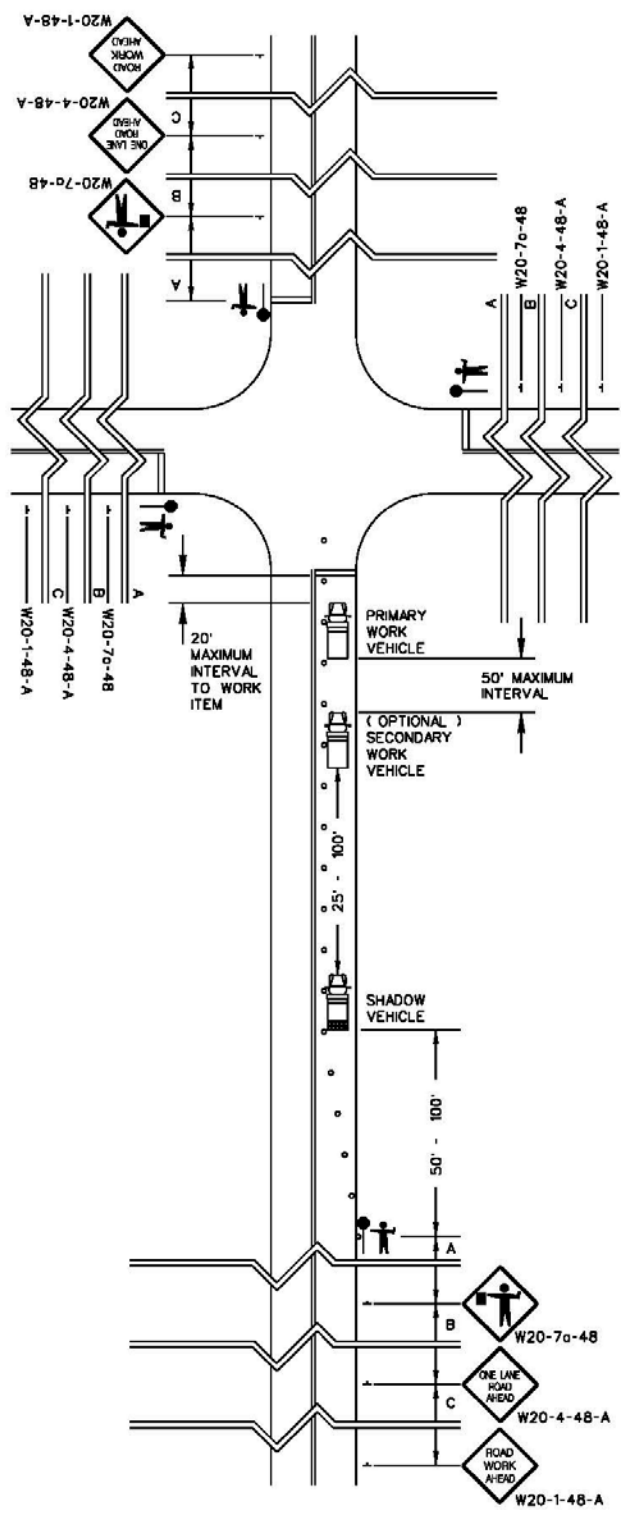

GENERAL NOTES:

1. THIS TRAFFIC CONTROL SETUP ILLUSTRATES AND SPECIFIES THE TRAFFIC CONTROL REQUIREMENTS FOR CONDUCTING PAVEMENT MARKING APPLICATIONS WITHIN THE APPROACH TO AN INTERSECTION ON A TWO-LANE TWO-WAY PRIMARY OR SECONDARY ROADWAY THAT REQUIRES THE PRESENCE OF PEDESTRIAN WORKERS AND EQUIPMENT WITHIN THE BOUNDARIES OF A TRAVEL LANE.
2. INSTALL AND CONDUCT FLAGGING OPERATIONS ON ALL APPROACHES TO THE INTERSECTION. ONLY FLAGGERS AND ADVANCE WARNING SIGNS ARE REQUIRED ON THE APPROACHES INTERSECTING THE TRAVEL LANE THE VEHICLE TRAIN IS OPERATING IN. TRAFFIC CONTROL DEVICES ARE NOT REQUIRED ON THE INTERSECTING ROADWAY APPROACHES.
3. MAINTAIN TWO-WAY RADIO COMMUNICATIONS BETWEEN ALL FLAGGERS.

VEHICLE TRAIN

PRIMARY WORK VEHICLE

AMBER COLORED HIGH INTENSITY ROTATING, FLASHING, OSCILLATING OR STROBE LIGHTS ARE REQUIRED ON THE WORK VEHICLE. VEHICLE HAZARD WARNING LIGHTS ARE ONLY PERMITTED AS A SUPPLEMENT TO THESE DEVICES.

SECONDARY WORK VEHICLE

A TRUCK MOUNTED ADVANCE WARNING ARROW PANEL OPERATING IN THE "FOUR CORNER" CAUTION MODE DISPLAYING ONE LAMP IN EACH CORNER IS REQUIRED ON A SECONDARY WORK VEHICLE.

A TRUCK MOUNTED ATTENUATOR IS OPTIONAL ON A SECONDARY WORK VEHICLE.

OPERATE THE SECONDARY WORK VEHICLE NO MORE THAN 50' IN ADVANCE OF THE PRIMARY WORK VEHICLE.

SHADOW VEHICLE

A TRUCK MOUNTED ADVANCE WARNING ARROW PANEL OPERATING IN THE "FOUR CORNER" CAUTION MODE DISPLAYING ONE LAMP IN EACH CORNER IS REQUIRED ON THE SHADOW VEHICLE.

A TRUCK MOUNTED ATTENUATOR IS OPTIONAL ON A SHADOW VEHICLE IN THIS MULTIPLE FLAGGER FLAGGING OPERATION.

OPERATE THE SHADOW VEHICLE IN THE SAME TRAVEL LANE AS THE PRIMARY WORK VEHICLE. OPERATE THE SHADOW VEHICLE 25' TO 100' IN ADVANCE OF THE PRIMARY WORK VEHICLE WHEN NO SECONDARY WORK VEHICLE IS UTILIZED. WHEN A SECONDARY WORK VEHICLE IS UTILIZED, OPERATE THE SHADOW VEHICLE 25' TO 100' IN ADVANCE OF THE SECONDARY WORK VEHICLE.

ADVANCE WARNING SIGN PLACEMENT INTERVALS	A	B	C
URBAN / RURAL (LOW SPEED) ≤ 35 MPH	200 FT	200 FT	200 FT
URBAN / RURAL (INTERMEDIATE SPEED) 40 MPH - 50 MPH	350 FT	350 FT	350 FT
RURAL (HIGH SPEED) ≥ 55 MPH	500 FT	500 FT	500 FT

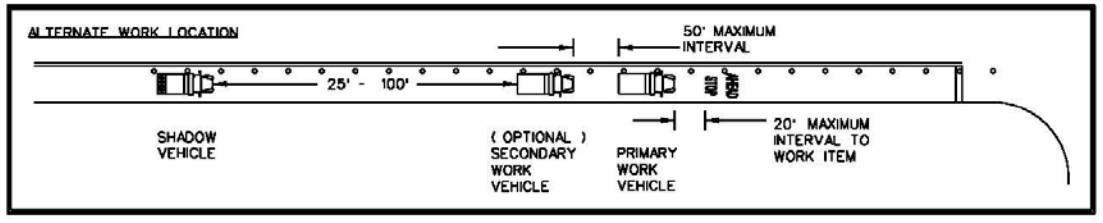

**PAVEMENT MARKING APPLICATION
INTERSECTIONS
VEHICLE TRAIN
RIGHT LANE CLOSURE
MULTILANE**

1. This traffic control setup specifies the traffic control requirements for applying pavement markings within the right travel lane approach to an intersection on a multilane primary or secondary roadway. This traffic control setup requires a work vehicle and a shadow vehicle. A secondary work vehicle is optional.
2. Install a standard lane closure for those pavement marking application activities that require the presence of pedestrian workers or equipment within the boundaries of a travel lane for a duration greater than 60 minutes.
3. Avoid conducting pavement marking application operations or similar work activities that interfere with or create disruptions to normal traffic operations during high traffic volume peak periods when possible.
4. The vehicle train shall include the primary work vehicle and a shadow vehicle. Supplement the shadow vehicle with a truck mounted advance warning arrow panel displaying a flashing arrow and a truck mounted attenuator. A secondary work vehicle is an optional addition to the vehicle train. When a secondary work vehicle is used, supplement the secondary work vehicle with a truck mounted advance warning arrow panel displaying a flashing arrow. A truck mounted attenuator is optional on a secondary work vehicle.
 - Operate the work vehicle no more than 20' in advance of the work activity site.
 - Operate the secondary work vehicle no more than 50' in advance of the primary work vehicle.
 - Operate the shadow vehicle 25' to 100' in advance of the primary work vehicle when no secondary work vehicle is utilized. When a secondary vehicle is utilized, operate the shadow vehicle 25' to 100' in advance of the secondary work vehicle.
5. Supplement the work vehicles and the shadow vehicles with amber colored auxiliary warning lights. The auxiliary warning lights shall be high intensity rotating, flashing, oscillating or strobe lights. Standard vehicle hazard warning lights are only permitted as a supplement to the auxiliary warning lights.

GENERAL NOTES:

1. THIS TRAFFIC CONTROL SETUP ILLUSTRATES AND SPECIFIES THE TRAFFIC CONTROL REQUIREMENTS FOR CONDUCTING PAVEMENT MARKING APPLICATIONS WITHIN THE RIGHT TRAVEL LANE APPROACH TO AN INTERSECTION ON A MULTILANE PRIMARY OR SECONDARY ROADWAY THAT REQUIRES THE PRESENCE OF PEDESTRIAN WORKERS AND EQUIPMENT WITHIN THE BOUNDARIES OF A TRAVEL LANE FOR A TIME DURATION NOT MORE THAN 60 MINUTES.
2. INSTALL A STANDARD LANE CLOSURE FOR THOSE PAVEMENT MARKING APPLICATION OPERATIONS THAT REQUIRE THE PRESENCE OF PEDESTRIAN WORKERS AND EQUIPMENT WITHIN THE BOUNDARIES OF A TRAVEL LANE FOR A TIME DURATION GREATER THAN 60 MINUTES.

**DRAWING 610-02
PAVEMENT MARKING
APPLICATION
INTERSECTIONS
VEHICLE TRAIN
RIGHT LANE CLOSURE
MULTILANE**

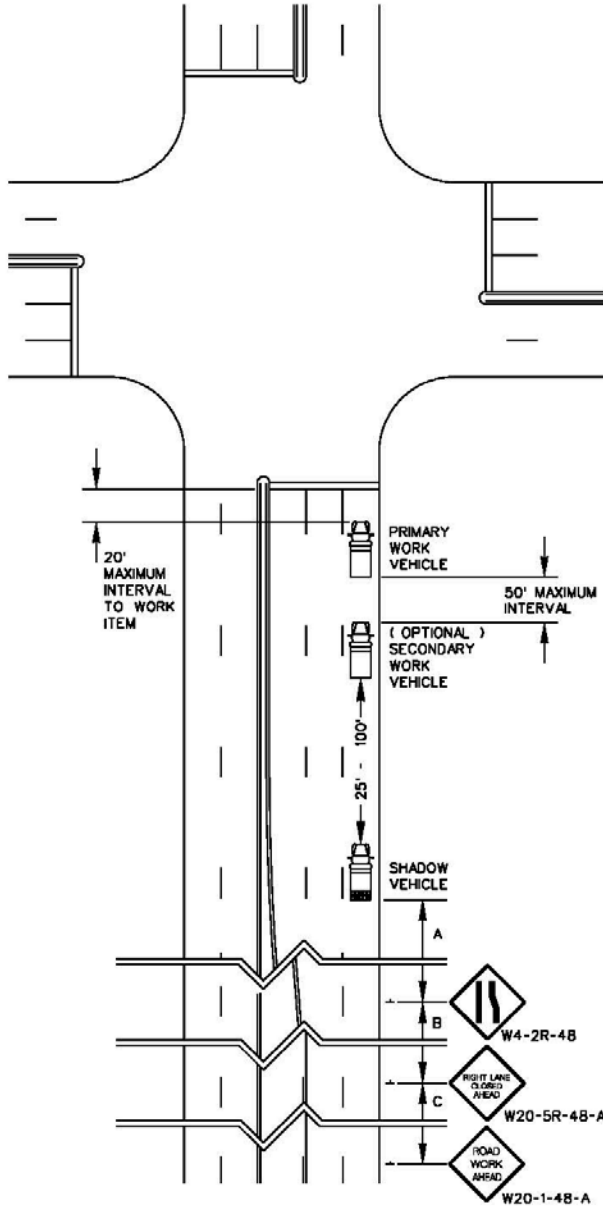

VEHICLE TRAIN

PRIMARY WORK VEHICLE

AMBER COLORED HIGH INTENSITY ROTATING, FLASHING, OSCILLATING OR STROBE LIGHTS ARE REQUIRED ON THE WORK VEHICLE. VEHICLE HAZARD WARNING LIGHTS ARE ONLY PERMITTED AS A SUPPLEMENT TO THESE DEVICES.

SECONDARY WORK VEHICLE

A TRUCK MOUNTED ADVANCE WARNING ARROW PANEL DISPLAYING A FLASHING ARROW IS REQUIRED ON A SECONDARY WORK VEHICLE.

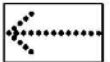

A TRUCK MOUNTED ATTENUATOR IS OPTIONAL ON A SECONDARY WORK VEHICLE.

OPERATE THE SECONDARY WORK VEHICLE NO MORE THAN 50' IN ADVANCE OF THE PRIMARY WORK VEHICLE.

SHADOW VEHICLE

A TRUCK MOUNTED ADVANCE WARNING ARROW PANEL DISPLAYING A FLASHING ARROW AND A TRUCK MOUNTED ATTENUATOR ARE REQUIRED ON THE SHADOW VEHICLE.

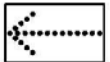

OPERATE THE SHADOW VEHICLE IN THE SAME TRAVEL LANE AS THE PRIMARY WORK VEHICLE. OPERATE THE SHADOW VEHICLE 25' TO 100' IN ADVANCE OF THE PRIMARY WORK VEHICLE WHEN NO SECONDARY WORK VEHICLE IS UTILIZED. WHEN A SECONDARY WORK VEHICLE IS UTILIZED, OPERATE THE SHADOW VEHICLE 25' TO 100' IN ADVANCE OF THE SECONDARY WORK VEHICLE.

ADVANCE WARNING SIGN PLACEMENT INTERVALS			
	A	B	C
URBAN / RURAL (LOW SPEED) ≤ 35 MPH	200 FT	200 FT	200 FT
URBAN / RURAL (INTERMEDIATE SPEED) 40 MPH - 50 MPH	350 FT	350 FT	350 FT
RURAL (HIGH SPEED) ≥ 55 MPH	500 FT	500 FT	500 FT

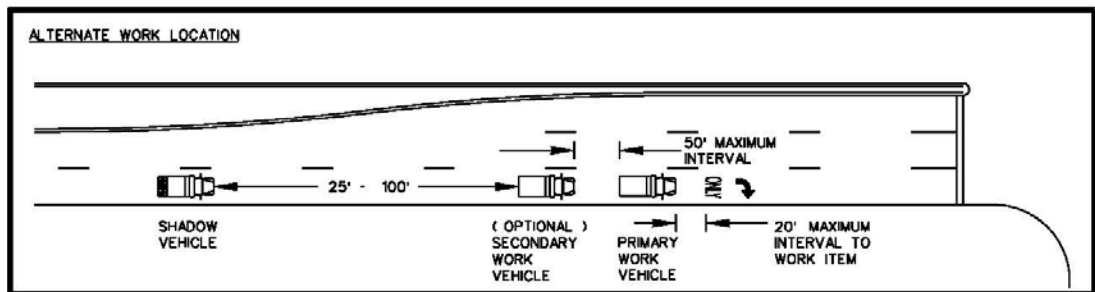

**PAVEMENT MARKING APPLICATION
INTERSECTIONS
VEHICLE TRAIN
INTERIOR LANE CLOSURE
MULTILANE
2 THROUGH LANES**

1. This traffic control setup specifies the traffic control requirements for applying pavement markings within an interior travel lane approach to an intersection on a multilane primary or secondary roadway. This traffic control setup requires a work vehicle and a shadow vehicle. A secondary work vehicle is optional.
2. Install a standard lane closure for those pavement marking application activities that require the presence of pedestrian workers or equipment within the boundaries of a travel lane for a duration greater than 60 minutes.
3. Avoid conducting pavement marking application operations or similar work activities that interfere with or create disruptions to normal traffic operations during high traffic volume peak periods when possible.
4. The vehicle train shall include the primary work vehicle and a shadow vehicle. Supplement the shadow vehicle with a truck mounted advance warning arrow panel displaying a flashing arrow and a truck mounted attenuator. A secondary work vehicle is an optional addition to the vehicle train. When a secondary work vehicle is used, supplement the secondary work vehicle with a truck mounted advance warning arrow panel displaying a flashing arrow. A truck mounted attenuator is optional on a secondary work vehicle.
 - Operate the work vehicle no more than 20' in advance of the work activity site.
 - Operate the secondary work vehicle no more than 50' in advance of the primary work vehicle.
 - Operate the shadow vehicle 25' to 100' in advance of the primary work vehicle when no secondary work vehicle is utilized. When a secondary vehicle is utilized, operate the shadow vehicle 25' to 100' in advance of the secondary work vehicle.
5. Supplement the work vehicles and the shadow vehicles with amber colored auxiliary warning lights. The auxiliary warning lights shall be high intensity rotating, flashing, oscillating or strobe lights. Standard vehicle hazard warning lights are only permitted as a supplement to the auxiliary warning lights.

GENERAL NOTES:

1. THIS TRAFFIC CONTROL SETUP ILLUSTRATES AND SPECIFIES THE TRAFFIC CONTROL REQUIREMENTS FOR CONDUCTING PAVEMENT MARKING APPLICATIONS WITHIN AN INTERIOR TRAVEL LANE APPROACH TO AN INTERSECTION ON A MULTILANE PRIMARY OR SECONDARY ROADWAY THAT REQUIRES THE PRESENCE OF PEDESTRIAN WORKERS AND EQUIPMENT WITHIN THE BOUNDARIES OF A TRAVEL LANE FOR A TIME DURATION NOT MORE THAN 60 MINUTES.
2. INSTALL A STANDARD LANE CLOSURE FOR THOSE PAVEMENT MARKING APPLICATION OPERATIONS THAT REQUIRE THE PRESENCE OF PEDESTRIAN WORKERS AND EQUIPMENT WITHIN THE BOUNDARIES OF A TRAVEL LANE FOR A TIME DURATION GREATER THAN 60 MINUTES.

**DRAWING 610-03
PAVEMENT MARKING
APPLICATION
INTERSECTIONS
VEHICLE TRAIN
INTERIOR LANE CLOSURE
MULTILANE
2 THROUGH LANES**

VEHICLE TRAIN

PRIMARY WORK VEHICLE

AMBER COLORED HIGH INTENSITY ROTATING, FLASHING, OSCILLATING OR STROBE LIGHTS ARE REQUIRED ON THE WORK VEHICLE. VEHICLE HAZARD WARNING LIGHTS ARE ONLY PERMITTED AS A SUPPLEMENT TO THESE DEVICES.

SECONDARY WORK VEHICLE

A TRUCK MOUNTED ADVANCE WARNING ARROW PANEL DISPLAYING A FLASHING ARROW IS REQUIRED ON A SECONDARY WORK VEHICLE.

A TRUCK MOUNTED ATTENUATOR IS OPTIONAL ON A SECONDARY WORK VEHICLE.

OPERATE THE SECONDARY WORK VEHICLE NO MORE THAN 50' IN ADVANCE OF THE PRIMARY WORK VEHICLE.

OPERATE THE ADVANCE WARNING ARROW PANEL IN THE DOUBLE ARROW MODE WHEN TRAVEL LANES OPEN TO TRAFFIC ARE PRESENT ON EACH SIDE OF THE SECONDARY WORK VEHICLE.

SHADOW VEHICLE

A TRUCK MOUNTED ADVANCE WARNING ARROW PANEL DISPLAYING A FLASHING ARROW AND A TRUCK MOUNTED ATTENUATOR ARE REQUIRED ON THE SHADOW VEHICLE.

OPERATE THE SHADOW VEHICLE IN THE SAME TRAVEL LANE AS THE PRIMARY WORK VEHICLE. OPERATE THE SHADOW VEHICLE 25' TO 100' IN ADVANCE OF THE PRIMARY WORK VEHICLE WHEN NO SECONDARY WORK VEHICLE IS UTILIZED. WHEN A SECONDARY WORK VEHICLE IS UTILIZED, OPERATE THE SHADOW VEHICLE 25' TO 100' IN ADVANCE OF THE SECONDARY WORK VEHICLE.

OPERATE THE ADVANCE WARNING ARROW PANEL IN THE DOUBLE ARROW MODE WHEN TRAVEL LANES OPEN TO TRAFFIC ARE PRESENT ON EACH SIDE OF THE SHADOW VEHICLE.

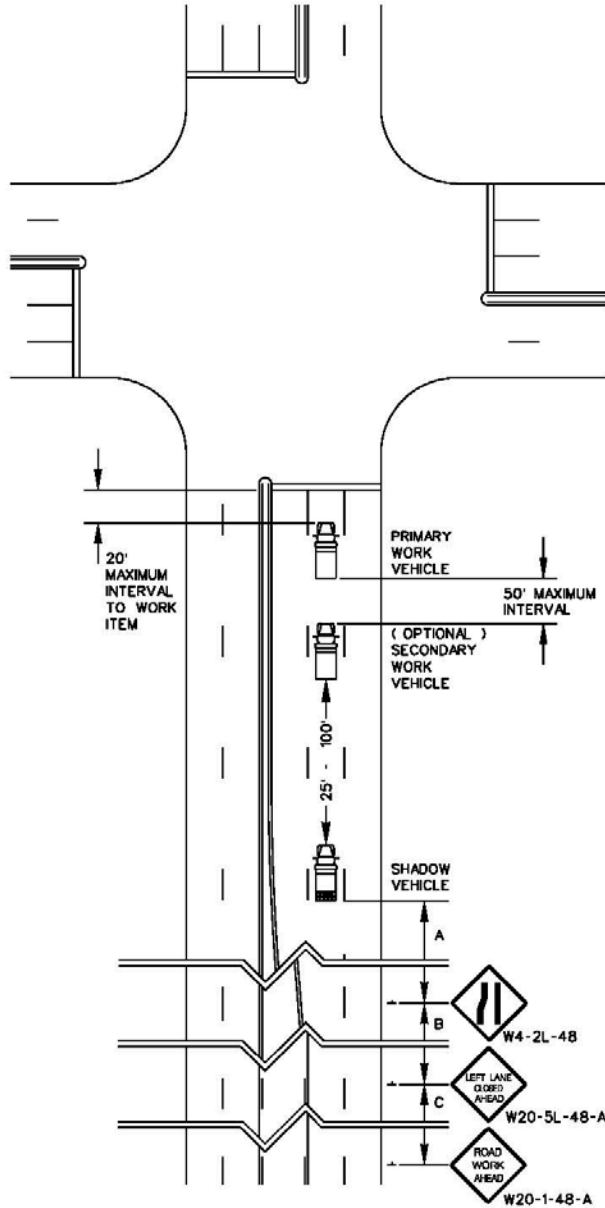

ALTERNATE DISPLAY

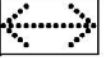

ALTERNATE DISPLAY

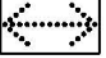

ADVANCE WARNING SIGN PLACEMENT INTERVALS			
	A	B	C
URBAN / RURAL (LOW SPEED) ≤ 35 MPH	200 FT	200 FT	200 FT
URBAN / RURAL (INTERMEDIATE SPEED) 40 MPH - 50 MPH	350 FT	350 FT	350 FT
RURAL (HIGH SPEED) ≥ 55 MPH	500 FT	500 FT	500 FT

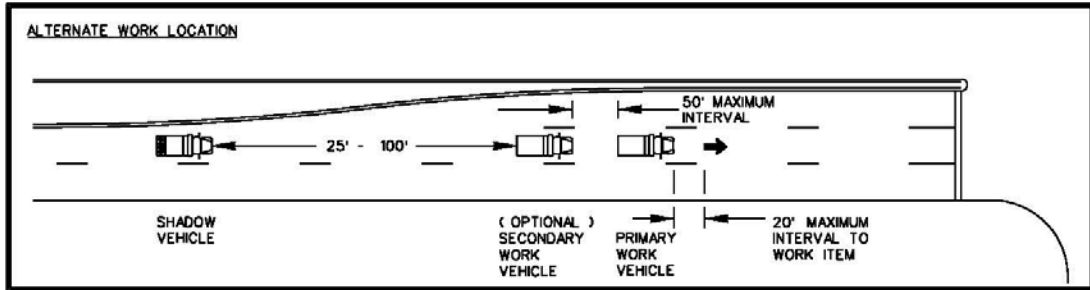

**PAVEMENT MARKING APPLICATION
INTERSECTIONS
VEHICLE TRAIN
INTERIOR LANE CLOSURE
MULTILANE
3 OR MORE THROUGH LANES**

1. This traffic control setup specifies the traffic control requirements for applying pavement markings within an interior travel lane approach to an intersection on a multilane primary or secondary roadway. This traffic control setup requires a work vehicle and a shadow vehicle. A secondary work vehicle is optional.
2. Install a standard lane closure for those pavement marking application activities that require the presence of pedestrian workers or equipment within the boundaries of a travel lane for a duration greater than 60 minutes.
3. Avoid conducting pavement marking application operations or similar work activities that interfere with or create disruptions to normal traffic operations during high traffic volume peak periods when possible.
4. The vehicle train shall include the primary work vehicle and a shadow vehicle. Supplement the shadow vehicle with a truck mounted advance warning arrow panel displaying a double arrow and a truck mounted attenuator. A secondary work vehicle is an optional addition to the vehicle train. When a secondary work vehicle is used, supplement the secondary work vehicle with a truck mounted advance warning arrow panel displaying a double arrow. A truck mounted attenuator is optional on a secondary work vehicle.
 - Operate the work vehicle no more than 20' in advance of the work activity site.
 - Operate the secondary work vehicle no more than 50' in advance of the primary work vehicle.
 - Operate the shadow vehicle 25' to 100' in advance of the primary work vehicle when no secondary work vehicle is utilized. When a secondary vehicle is utilized, operate the shadow vehicle 25' to 100' in advance of the secondary work vehicle.
5. Supplement the work vehicles and the shadow vehicles with amber colored auxiliary warning lights. The auxiliary warning lights shall be high intensity rotating, flashing, oscillating or strobe lights. Standard vehicle hazard warning lights are only permitted as a supplement to the auxiliary warning lights.

GENERAL NOTES:

1. THIS TRAFFIC CONTROL SETUP ILLUSTRATES AND SPECIFIES THE TRAFFIC CONTROL REQUIREMENTS FOR CONDUCTING PAVEMENT MARKING APPLICATIONS WITHIN AN INTERIOR TRAVEL LANE APPROACH TO AN INTERSECTION ON A MULTILANE PRIMARY OR SECONDARY ROADWAY THAT REQUIRES THE PRESENCE OF PEDESTRIAN WORKERS AND EQUIPMENT WITHIN THE BOUNDARIES OF A TRAVEL LANE FOR A TIME DURATION NOT MORE THAN 60 MINUTES.
2. INSTALL A STANDARD LANE CLOSURE FOR THOSE PAVEMENT MARKING APPLICATION OPERATIONS THAT REQUIRE THE PRESENCE OF PEDESTRIAN WORKERS AND EQUIPMENT WITHIN THE BOUNDARIES OF A TRAVEL LANE FOR A TIME DURATION GREATER THAN 60 MINUTES.

**DRAWING 610-04
PAVEMENT MARKING
APPLICATION
INTERSECTIONS
VEHICLE TRAIN
INTERIOR LANE CLOSURE
MULTILANE
3 OR MORE THROUGH LANES**

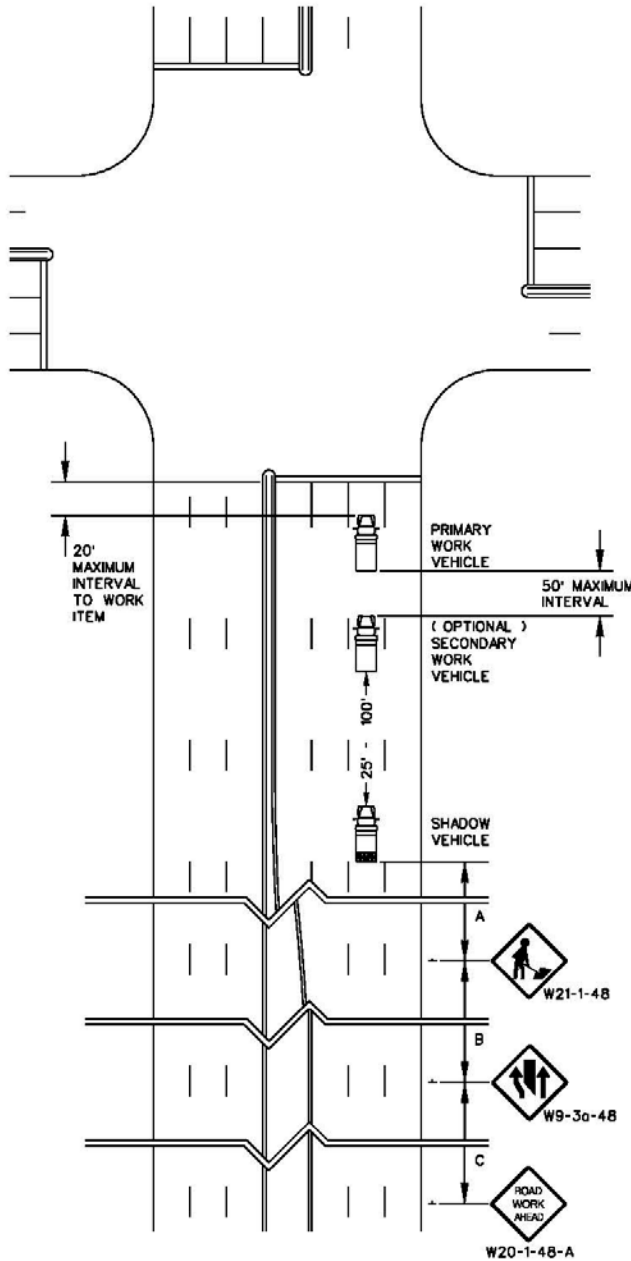

VEHICLE TRAIN

PRIMARY WORK VEHICLE

AMBER COLORED HIGH INTENSITY ROTATING, FLASHING, OSCILLATING OR STROBE LIGHTS ARE REQUIRED ON THE WORK VEHICLE. VEHICLE HAZARD WARNING LIGHTS ARE ONLY PERMITTED AS A SUPPLEMENT TO THESE DEVICES.

SECONDARY WORK VEHICLE

A TRUCK MOUNTED ADVANCE WARNING ARROW PANEL DISPLAYING A DOUBLE ARROW IS REQUIRED ON A SECONDARY WORK VEHICLE.

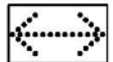

A TRUCK MOUNTED ATTENUATOR IS OPTIONAL ON A SECONDARY WORK VEHICLE.

OPERATE THE SECONDARY WORK VEHICLE NO MORE THAN 50' IN ADVANCE OF THE PRIMARY WORK VEHICLE.

OPERATE THE ADVANCE WARNING ARROW PANEL IN THE DOUBLE ARROW MODE WHEN TRAVEL LANES OPEN TO TRAFFIC ARE PRESENT ON EACH SIDE OF THE SECONDARY WORK VEHICLE.

SHADOW VEHICLE

A TRUCK MOUNTED ADVANCE WARNING ARROW PANEL DISPLAYING A DOUBLE ARROW AND A TRUCK MOUNTED ATTENUATOR ARE REQUIRED ON THE SHADOW VEHICLE.

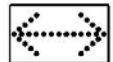

OPERATE THE SHADOW VEHICLE IN THE SAME TRAVEL LANE AS THE PRIMARY WORK VEHICLE. OPERATE THE SHADOW VEHICLE 25' TO 100' IN ADVANCE OF THE PRIMARY WORK VEHICLE WHEN NO SECONDARY WORK VEHICLE IS UTILIZED. WHEN A SECONDARY WORK VEHICLE IS UTILIZED, OPERATE THE SHADOW VEHICLE 25' TO 100' IN ADVANCE OF THE SECONDARY WORK VEHICLE.

OPERATE THE ADVANCE WARNING ARROW PANEL IN THE DOUBLE ARROW MODE WHEN TRAVEL LANES OPEN TO TRAFFIC ARE PRESENT ON EACH SIDE OF THE SHADOW VEHICLE.

ADVANCE WARNING SIGN PLACEMENT INTERVALS			
	A	B	C
URBAN / RURAL (LOW SPEED) ≤ 35 MPH	200 FT	200 FT	200 FT
URBAN / RURAL (INTERMEDIATE SPEED) 40 MPH - 50 MPH	350 FT	350 FT	350 FT
RURAL (HIGH SPEED) ≥ 55 MPH	500 FT	500 FT	500 FT

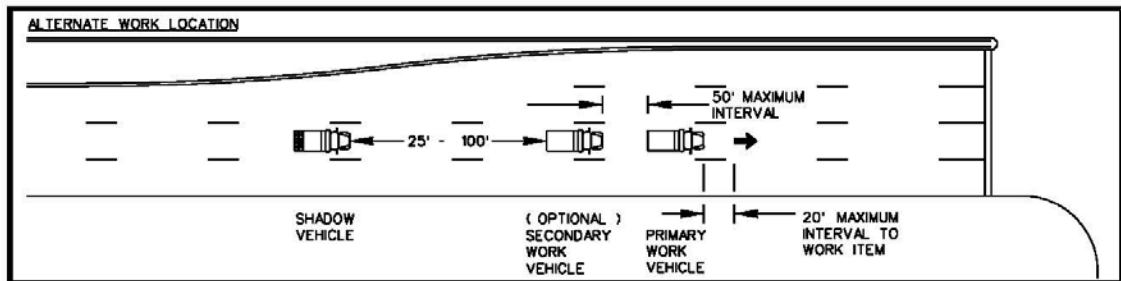

***EXTENDED
ROAD CLOSURES***

STANDARD DRAWING NO. 705-01

Through

STANDARD DRAWING NO. 705-02

**EXTENDED ROAD CLOSURE
OF
ROADWAY**

1. Measure all advance warning sign locations from the limits of the work area.
2. Install advance warning signs mounted on portable sign supports no less than 4 feet from the near edge of the sign to the near edge of an adjacent travel lane on roadways with grass shoulders and no less than 6 feet from the near edge of the sign to the near edge of an adjacent travel lane on roadways with paved shoulders. When curb & gutter is present, install the sign no less than 2 feet from the near edge of the sign to the face of the curb.
3. The advance warning sign placement intervals indicated on the illustration are for normal conditions. Adjustments to the distance intervals between the signs may be necessary due to sight distance restrictions such as curves and hills.
4. The minimum mounting height of signs mounted on portable supports during a traffic control set up for a road closure is 5 feet from the ground to the bottom edge of the sign. The mounting height of signs mounted on ground mounted posts during a traffic control set up for a road closure is 7 feet to 8 feet from the bottom edge of the sign to the grade elevation of the near edge of the adjacent travel lane.
5. When utilizing u-channel posts, the ground support (stub) is always between oncoming traffic and the sign support. Attach the sign support to the ground support (stub) on the side of the ground support (stub) opposite of oncoming traffic. Install the breakaway system to function in accordance with the direction of traffic in the adjacent travel lane.
6. All supplemental signs attached to Type III barricades shall be constructed of an approved retroreflective roll-up material or an approved aluminum laminate composite rigid sign substrate material such as "Alpolic", "Dibond", or "Reynolite". Other rigid sign substrates such as 0.08 and 0.10 aluminum sign blanks are PROHIBITED for attachment to a Type III barricade.
7. The traffic control set up illustrated applies to only one approach to the work area. Each approach shall require duplication of this traffic control set up as illustrated.
8. For the traffic control quantities for each approach. See *Table 16, Traffic Control Devices Quantities for Extended Road Closure of Roadway (Single Approach) (Drawing No. 705-01)*.

Table 16 **Traffic Control Devices Quantities for Extended Road Closure
of Roadway
(Single Approach)
(Drawing No. 705-01)**

TRAFFIC CONTROL DEVICES	QUANTITY
TYPE III BARRICADES	42 LF
PERMANENT CONSTRUCTION SIGNS (Ground Mounted)	64 SF
PERMANENT CONSTRUCTION SIGNS (Barricade Mounted)	35 SF
TYPE "B" HIGH INTENSITY FLASHING WARNING LIGHTS	8 EA
16" x 16" ORANGE FLAGS	8 EA

GENERAL NOTES:

1. THIS TRAFFIC CONTROL SETUP ILLUSTRATES AND SPECIFIES THE TRAFFIC CONTROL REQUIREMENTS FOR INSTALLING AND MAINTAINING AN EXTENDED ROAD CLOSURE OF A PRIMARY OR SECONDARY ROADWAY.
2. THE TRAFFIC CONTROL SETUP ILLUSTRATED APPLIES TO ONLY ONE APPROACH TO THE WORK AREA.

DRAWING 705-01
EXTENDED
ROAD CLOSURE
OF
ROADWAY

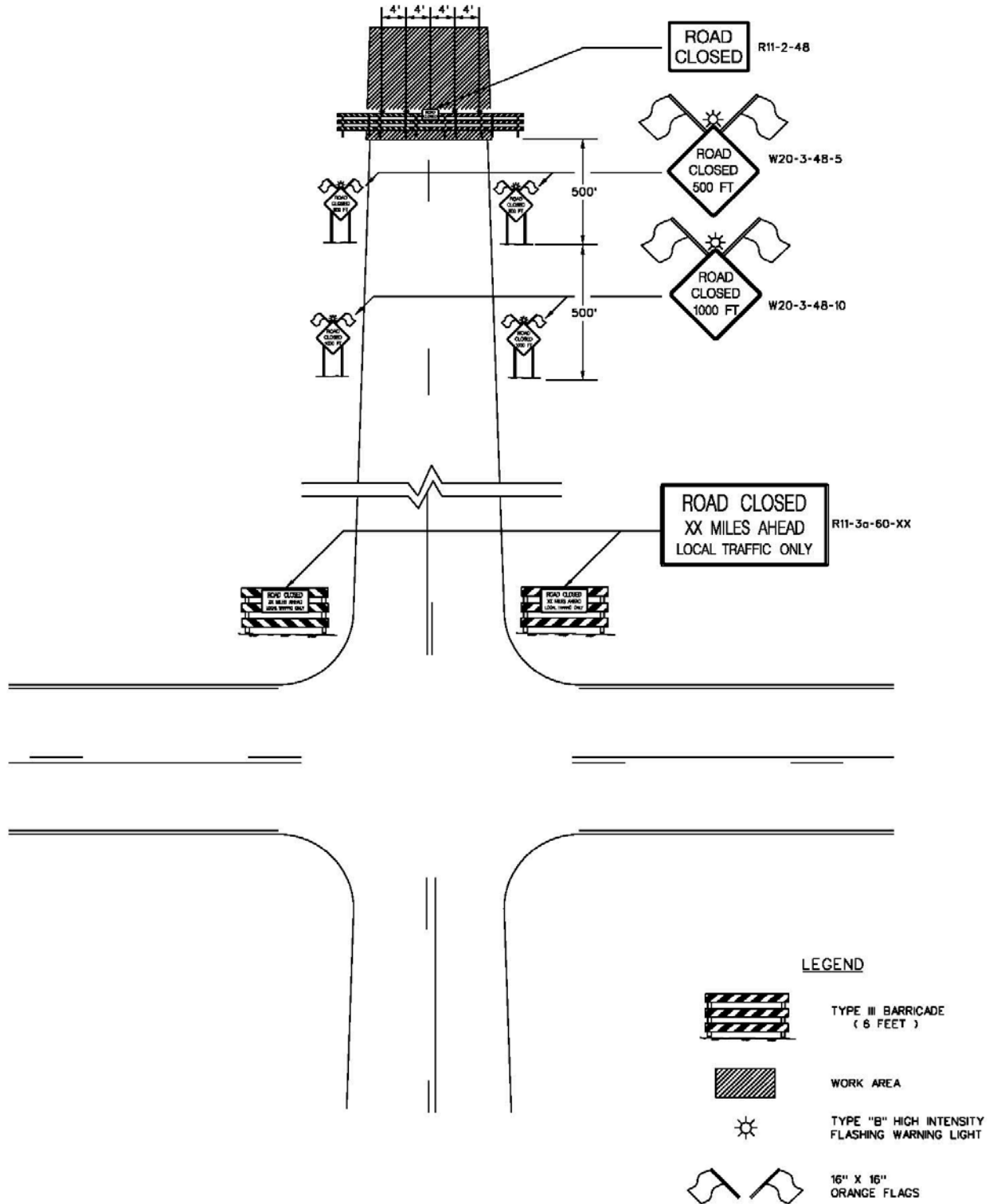

**EXTENDED ROAD CLOSURE
FOR
BRIDGE WORK**

1. Measure all advance warning sign locations from the limits of the work area.
2. Install advance warning signs mounted on portable sign supports no less than 4 feet from the near edge of the sign to the near edge of an adjacent travel lane on roadways with grass shoulders and no less than 6 feet from the near edge of the sign to the near edge of an adjacent travel lane on roadways with paved shoulders. When curb & gutter is present, install the sign no less than 2 feet from the near edge of the sign to the face of the curb.
3. The advance warning sign placement intervals indicated on the illustration are for normal conditions. Adjustments to the distance intervals between the signs may be necessary due to sight distance restrictions such as curves and hills.
4. The minimum mounting height of signs mounted on portable supports during a traffic control set up for a road closure is 5 feet from the ground to the bottom edge of the sign. The mounting height of signs mounted on ground mounted posts during a traffic control set up for a road closure is 7 feet to 8 feet from the bottom edge of the sign to the grade elevation of the near edge of the adjacent travel lane.
5. When utilizing u-channel posts, the ground support (stub) is always between oncoming traffic and the sign support. Attach the sign support to the ground support (stub) on the side of the ground support (stub) opposite of oncoming traffic. Install the breakaway system to function in accordance with the direction of traffic in the adjacent travel lane.
6. All supplemental signs attached to Type III barricades shall be constructed of an approved retroreflective roll-up material or an approved aluminum laminate composite rigid sign substrate material such as "Alpolic", "Dibond", or "Reynolite". Other rigid sign substrates such as 0.08 and 0.10 aluminum sign blanks are PROHIBITED for attachment to a Type III barricade.
7. The traffic control set up illustrated applies to only one approach to the work area. Each approach shall require duplication of this traffic control set up as illustrated.
8. For the traffic control quantities for each approach. See *Table 17, Traffic Control Devices Quantities for Extended Road Closure - Bridge Work (Single Approach) (Drawing No. 705-02)*.

Table 17 **Traffic Control Devices Quantities for Extended Road Closure - Bridge Work (Single Approach) (Drawing No. 705-02)**

TRAFFIC CONTROL DEVICES	QUANTITY
TYPE III BARRICADES	42 LF
PERMANENT CONSTRUCTION SIGNS (Ground Mounted)	64 SF
PERMANENT CONSTRUCTION SIGNS (Barricade Mounted)	35 SF
TYPE "B" HIGH INTENSITY FLASHING WARNING LIGHTS	8 EA
16" x 16" ORANGE FLAGS	8 EA

GENERAL NOTES:

1. THIS TRAFFIC CONTROL SETUP ILLUSTRATES AND SPECIFIES THE TRAFFIC CONTROL REQUIREMENTS FOR INSTALLING AND MAINTAINING AN EXTENDED ROAD CLOSURE OF A PRIMARY OR SECONDARY ROADWAY AT A BRIDGE LOCATION.
2. THE TRAFFIC CONTROL SETUP ILLUSTRATED APPLIES TO ONLY ONE APPROACH TO THE WORK AREA.

**DRAWING 705-02
EXTENDED
ROAD CLOSURE
FOR
BRIDGE WORK**

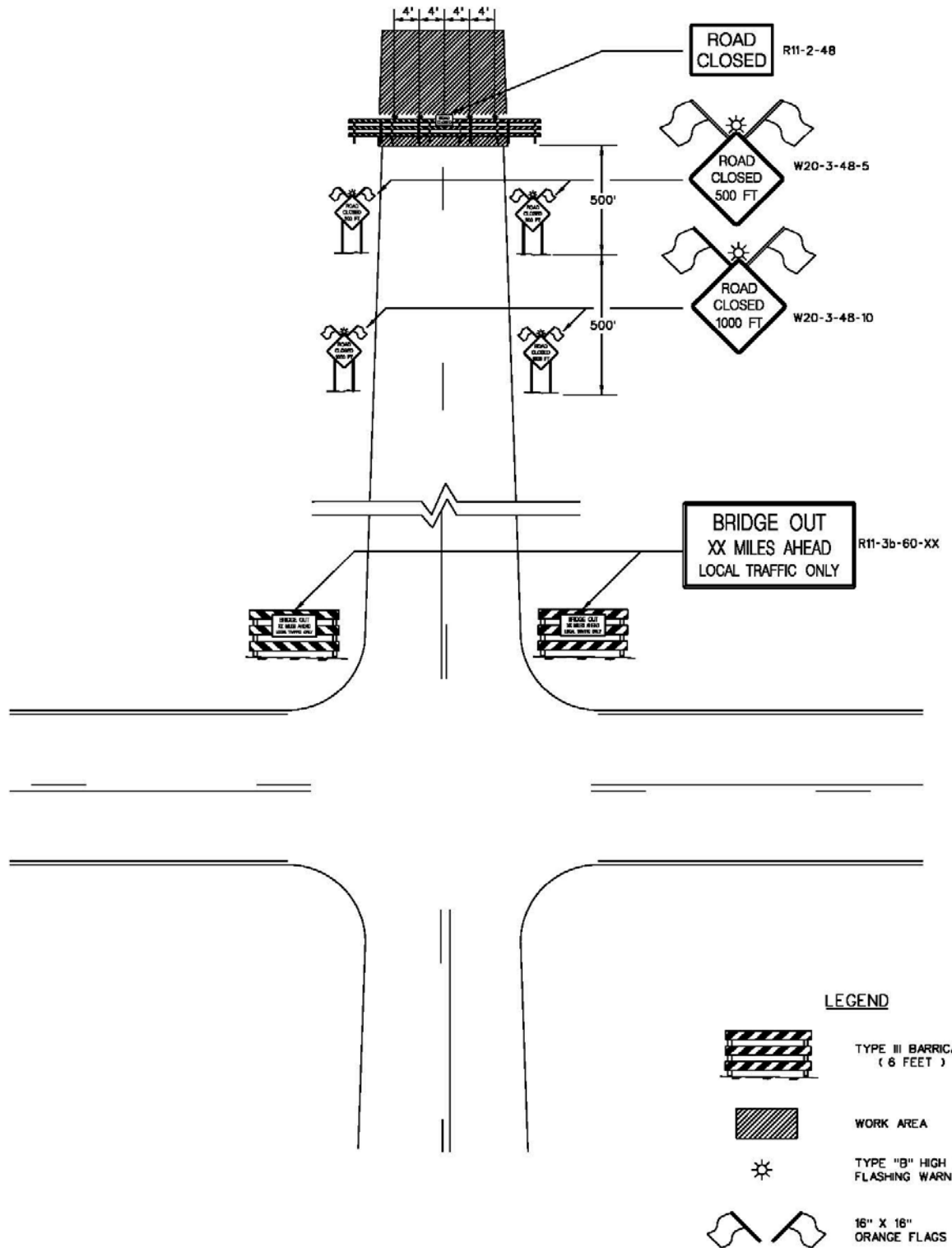

DETOUR SIGNING

STANDARD DRAWING NO. 805-01

Through

STANDARD DRAWING NO. 805-02

**DETOUR SIGNING
FOR
PRIMARY AND INTERSTATE ROUTES**

1. Measure all sign locations as indicated.
2. The minimum mounting height for a detour sign assembly with multiple sign panels mounted on a ground mounted post is no less than 5 feet from the grade elevation of the near edge of the adjacent travel lane to the bottom of the route sign or the detour sign panel (M4-9) unless otherwise directed by the Department.
The mounting height for regulatory and advance warning sign assemblies mounted on a ground mounted post is 7 feet to 8 feet from the grade elevation of the near edge of the adjacent travel lane to the bottom of the primary sign panel.
3. Determine the lateral location of a detour sign assembly adjacent to the roadway by measuring from the nearest edge of the detour sign assembly to the critical point. See *Table 18, Detour Sign Assembly Guidelines for Lateral Location (Primary and Interstate Routes) (Drawing No. 805-01)*. Reduction of these distances is acceptable in locations where the necessary shoulder widths are unavailable.

Table 18 *Detour Sign Assembly Guidelines for Lateral Location
(Primary and Interstate Routes)
(Drawing No. 805-01)*

TYPE of ROADWAY EDGE	DISTANCE	CRITICAL POINT
Grass Shoulders	6 to 12 Feet	Near Edge of Adjacent Travel Lane
Paved Shoulders	2 Feet	Edge of Pavement
Curb & Gutter	2 Feet	Face of Curb

4. The sign placement intervals indicated on the illustration are for normal conditions. Adjustments to the distance intervals between the signs may be necessary due to sight distance restrictions such as curves and hills.
5. All supplemental signs attached to Type III barricades shall be constructed of an approved retroreflective roll-up material or an approved aluminum laminate composite rigid sign substrate material such as "Alpolic", "Dibond", or "Reynolite". Other rigid sign substrates such as 0.08 and 0.10 aluminum sign blanks are PROHIBITED for attachment to a Type III barricade.

DRAWING 805-01
 DETOUR SIGNING
 FOR
 PRIMARY & INTERSTATE
 ROUTES

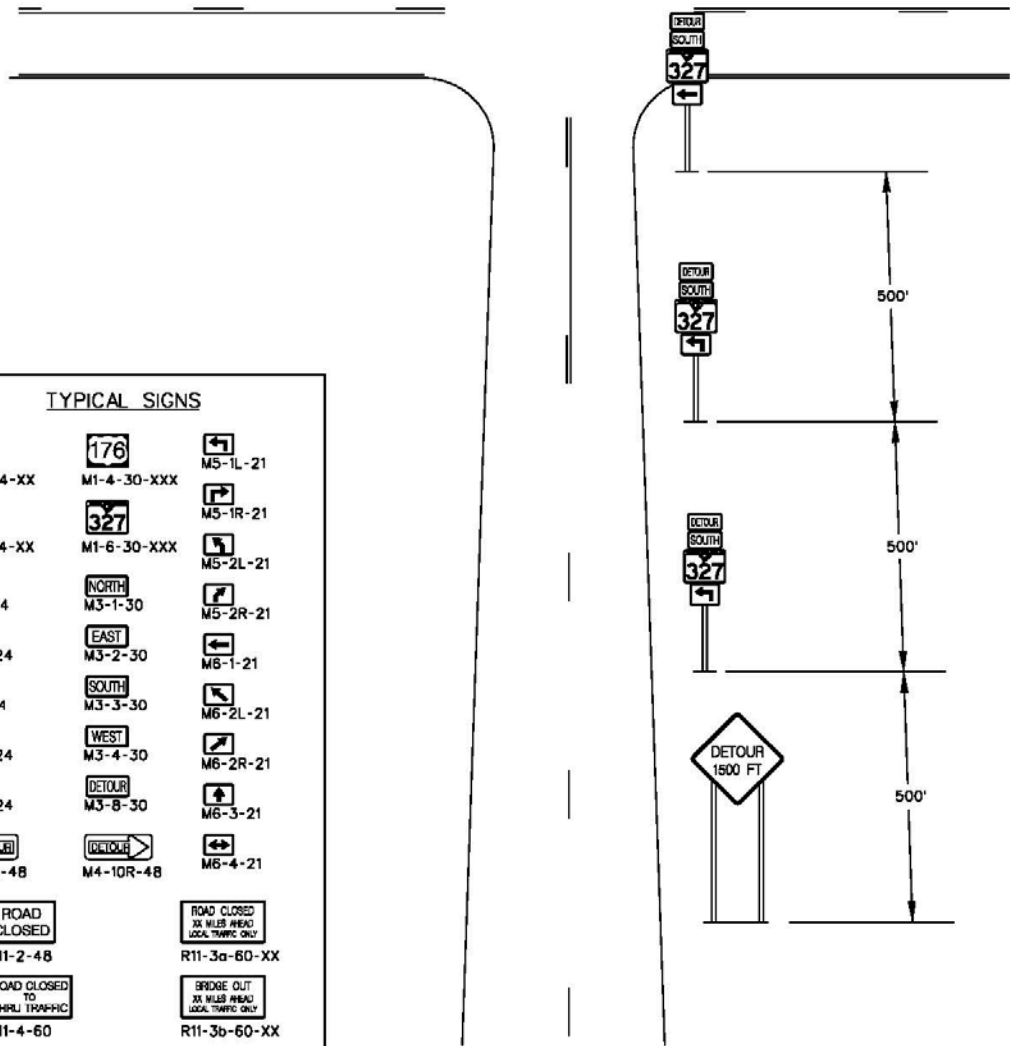
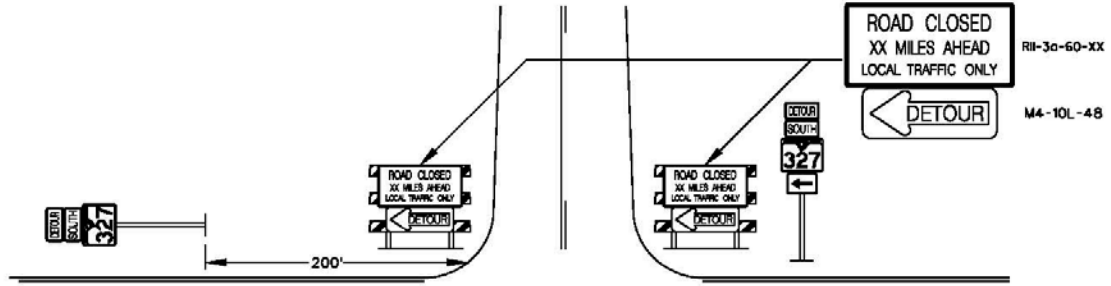

TYPICAL SIGNS

M1-4-24-XX	M1-4-30-XXX	M5-1L-21
M1-6-24-XX	M1-6-30-XXX	M5-1R-21
M3-1-24	M3-1-30	M5-2L-21
M3-2-24	M3-2-30	M6-1-21
M3-3-24	M3-3-30	M6-2L-21
M3-3-24	M3-4-30	M6-2R-21
M4-8-24	M3-8-30	M6-3-21
M4-10L-48	M4-10R-48	M6-4-21
R11-2-48	R11-3a-60-XX	
R11-4-60	R11-3b-60-XX	

NOTE: ALWAYS INSTALL 24" SIGNS WITH 24" SIGNS AND 30" SIGNS WITH 30" SIGNS. SIGNING IS NOT LIMITED TO THOSE SIGNS ILLUSTRATED.

**DETOUR SIGNING
FOR
SECONDARY ROUTES**

1. Measure all sign locations as indicated.
2. The minimum mounting height for a detour sign assembly with multiple sign panels mounted on a ground mounted post is no less than 5 feet from the grade elevation of the near edge of the adjacent travel lane to the bottom of the route sign or the detour sign panel (M4-9) unless otherwise directed by the Department.
The mounting height for regulatory and advance warning sign assemblies mounted on a ground mounted post is 7 feet to 8 feet from the grade elevation of the near edge of the adjacent travel lane to the bottom of the primary sign panel.
3. Determine the lateral location of a detour sign assembly adjacent to the roadway by measuring from the nearest edge of the detour sign assembly to the critical point. See *Table 19, Detour Sign Assembly Guidelines for Lateral Location (Secondary Routes) (Drawing No. 805-02)*. Reduction of these distances is acceptable in locations where the necessary shoulder widths are unavailable.

Table 19 *Detour Sign Assembly Guidelines for Lateral Location (Secondary Routes) (Drawing No. 805-02)*

TYPE of ROADWAY EDGE	DISTANCE	CRITICAL POINT
Grass Shoulders	6 to 12 Feet	Near Edge of Adjacent Travel Lane
Paved Shoulders	2 Feet	Edge of Pavement
Curb & Gutter	2 Feet	Face of Curb

4. The sign placement intervals indicated on the illustration are for normal conditions. Adjustments to the distance intervals between the signs may be necessary due to sight distance restrictions such as curves and hills.
5. All supplemental signs attached to Type III barricades shall be constructed of an approved retroreflective roll-up material or an approved aluminum laminate composite rigid sign substrate material such as "Alpolic", "Dibond", or "Reynolite". Other rigid sign substrates such as 0.08 and 0.10 aluminum sign blanks are PROHIBITED for attachment to a Type III barricade.

DRAWING 805-02
DETOUR SIGNING
FOR
SECONDARY
ROUTES

SIGN PLACEMENT AND SPACING INTERVALS				
SPEED LIMIT	a	b	c	d
35 MPH or LESS	50'	100'	200'	200'
40 MPH to 50 MPH	75'	150'	350'	350'
55 MPH or GREATER	100'	200'	500'	500'

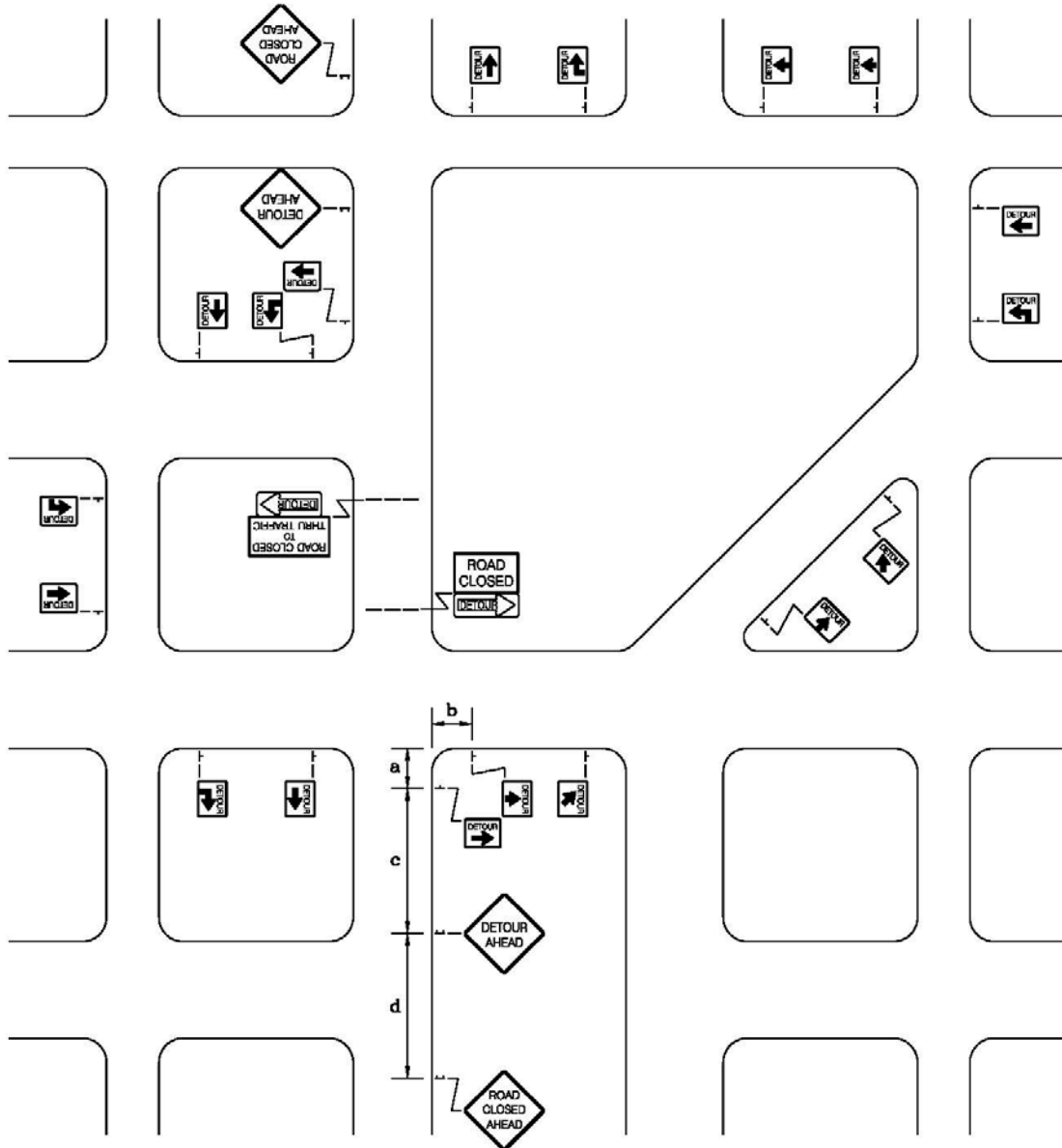

TYPICAL SIGNS									
W20-2-48-A	W20-3-48-A	M4-9-30	M4-9L-30	M4-9.1L-30	M4-9.2L-30	M4-10L-48	R11-2-48	R11-3a-60-XX	R11-3b-60-XX
			M4-9R-30	M4-9.1R-30	M4-9.2R-30	M4-10R-48	R11-4-60	R11-3a-60-XX	R11-3b-60-XX

TRAFFIC CONTROL REQUIREMENTS FOR SPECIFIC MAINTENANCE PERFORMANCE ACTIVITIES

This section provides recommended typical work zone traffic control installations and applications for specific maintenance performance activities. Dependent upon specific site conditions, typical work zone traffic control installations other than those specified for each specific maintenance performance activity may be considered. However, obtain approval from the District Engineering Administrator or designee prior to utilizing typical work zone traffic control installations other than those recommended for a specific maintenance performance activity.

The designs and applications of the typical work zone traffic control installations provided in this manual are based upon the roadway characteristics and traffic conditions such as roadway types, speed classifications, traffic volume classifications and work durations.

The typical work zone traffic control installations and applications provided for each maintenance performance activity is based upon the roadway characteristics. Each maintenance performance activity is divided into the three roadway types where the activities may occur; two-lane two-way primary and secondary roadways, multilane primary and secondary roadways and interstate roadways. These three groups may be further broken down based upon speed and volume classifications and work durations.

MULTIPLE TYPICAL WORK ZONE TRAFFIC CONTROL INSTALLATIONS AND APPLICATIONS ARE USUALLY PROVIDED FOR EACH ROADWAY TYPE WITHIN EACH MAINTENANCE PERFORMANCE ACTIVITY. THE RESIDENT ENGINEER SHOULD EVALUATE THE WORK OPERATIONS AND THE WORK SITE LOCATIONS TO DETERMINE WHICH OF THE TYPICAL WORK ZONE TRAFFIC CONTROL INSTALLATIONS ARE BEST SUITED FOR THE ROADWAY WHERE THE INTENDED MAINTENANCE PERFORMANCE ACTIVITIES ARE TO OCCUR.

PERFORMANCE ACTIVITY 102

SURFACE REPAIRS

**WORK DESCRIPTION 1
WORK DESCRIPTION 2
WORK DESCRIPTION 3**

**Patching / Minor Leveling
Major Leveling / Strengthening
Resurface**

102 SURFACE REPAIRS

ACTIVITY DESCRIPTION

Repair pavements, paved shoulders and approaches.

WORK DESCRIPTION 1 Patching / Minor Leveling

Patching of potholes, restoration of the pavement edge and the leveling of small depressions and irregularities by hand using asphalt and/or with pothole patching machine using stone and emulsion.

TRAFFIC CONTROL

TWO-LANE TWO-WAY ROADWAYS

Utilize intermittent mobile operations for these work activities under the following conditions:

Condition 1 - The maximum time duration of a stop is 15 minutes if the work vehicle and/or the shadow vehicle encroach upon a travel lane more than 2 feet.

Condition 2 - The maximum time duration of a stop is 30 minutes if the work vehicle and/or the shadow vehicle encroach upon a travel lane 2 feet or less.

During intermittent mobile operations, utilize a shadow vehicle when the stopping sight distance interval between the work vehicle or road machinery and an approaching motorist is unavailable based upon the posted regulatory speed limit of the work location.

Flagging operations are required for work activities that cannot be conducted under the conditions required for intermittent mobile operations.

TYPICAL DRAWING APPLICATIONS

FLAGGING OPERATIONS

DRAWING 405-01-A	-	FLAGGING OPERATIONS MULTIPLE FLAGGERS TWO-LANE TWO-WAY ROADWAYS PRIMARY & SECONDARY ROUTES
DRAWING 405-01-B(1)	-	FLAGGING OPERATIONS MULTIPLE FLAGGERS TWO-LANE TWO-WAY ROADWAYS PRIMARY & SECONDARY ROUTES STOP SIGN CONTROLLED SIDE ROADS
DRAWING 405-01-B(2)	-	FLAGGING OPERATIONS MULTIPLE FLAGGERS TWO-LANE TWO-WAY ROADWAYS PRIMARY & SECONDARY ROUTES 4-WAY STOP CONTROLLED INTERSECTION
DRAWING 405-01-C(1)	-	FLAGGING OPERATIONS MULTIPLE FLAGGERS TWO-LANE TWO-WAY ROADWAYS PRIMARY & SECONDARY ROUTES TRAFFIC SIGNAL CONTROLLED INTERSECTION LAW ENFORCEMENT OFFICER(S)
DRAWING 405-01-C(2)	-	FLAGGING OPERATIONS MULTIPLE FLAGGERS TWO-LANE TWO-WAY ROADWAYS PRIMARY & SECONDARY ROUTES TRAFFIC SIGNAL CONTROLLED INTERSECTION FLAGGERS

- DRAWING 405-01-D(1)** - FLAGGING OPERATIONS
 MULTIPLE FLAGGERS
 TWO-LANE TWO-WAY ROADWAYS
 PRIMARY & SECONDARY ROUTES
 WORK ACTIVITY AREA
 BEGINNING at an
 INTERSECTION with a
 TWO-LANE TWO-WAY ROADWAY
 DEPARTURE LANE
- DRAWING 405-01-D(2)** - FLAGGING OPERATIONS
 MULTIPLE FLAGGERS
 TWO-LANE TWO-WAY ROADWAYS
 PRIMARY & SECONDARY ROUTES
 WORK ACTIVITY AREA
 TERMINATING at an
 INTERSECTION with a
 TWO-LANE TWO-WAY ROADWAY
 APPROACH LANE
- DRAWING 405-01-E(1)**
DRAWING 405-01-E(2) - FLAGGING OPERATIONS
 MULTIPLE FLAGGERS
 TWO-LANE TWO-WAY ROADWAYS
 PRIMARY & SECONDARY ROUTES
 WORK ACTIVITY AREA
 INTERSECTIONS with
 LOW SPEED
 < / = 35 MPH
 MULTILANE ROADWAYS
- DRAWING 405-01-F(1)**
DRAWING 405-01-F(2) - FLAGGING OPERATIONS
 MULTIPLE FLAGGERS
 TWO-LANE TWO-WAY ROADWAYS
 PRIMARY & SECONDARY ROUTES
 WORK ACTIVITY AREA
 INTERSECTIONS with
 INTERMEDIATE SPEED to HIGH SPEED
 40 MPH - 60 MPH
 MULTILANE ROADWAYS
- DRAWING 405-02** - FLAGGING OPERATIONS
 SINGLE FLAGGER OPERATION
 LOW VOLUME
 LOW SPEED TO INTERMEDIATE SPEED
 TWO-LANE TWO-WAY ROADWAYS
 PRIMARY & SECONDARY ROUTES

MOBILE OPERATIONS – INTERMITTENT

- DRAWING 535-01-A** - MOBILE OPERATIONS – INTERMITTENT
 STOPPING SIGHT DISTANCE
 VEHICLE TRAIN REQUIREMENTS
 VERTICAL CURVE (HILL)
- DRAWING 535-01-B** - MOBILE OPERATIONS – INTERMITTENT
 STOPPING SIGHT DISTANCE
 VEHICLE TRAIN REQUIREMENTS
 HORIZONTAL CURVE (CURVE)
- DRAWING 535-02-A** - MOBILE OPERATIONS – INTERMITTENT
 LOW VOLUME
 LOW SPEED
 PRIMARY & SECONDARY ROUTES

- DRAWING 535-02-B** - MOBILE OPERATIONS – INTERMITTENT
LOW VOLUME
INTERMEDIATE SPEED TO HIGH SPEED
PRIMARY & SECONDARY ROUTES
- DRAWING 535-03-A** - MOBILE OPERATIONS – INTERMITTENT
INTERMEDIATE VOLUME
LOW SPEED
PRIMARY & SECONDARY ROUTES
- DRAWING 535-03-B** - MOBILE OPERATIONS – INTERMITTENT
INTERMEDIATE VOLUME
INTERMEDIATE SPEED TO HIGH SPEED
PRIMARY & SECONDARY ROUTES
- DRAWING 535-04-A** - MOBILE OPERATIONS – INTERMITTENT
HIGH VOLUME
LOW SPEED
PRIMARY & SECONDARY ROUTES
- DRAWING 535-04-C** - MOBILE OPERATIONS – INTERMITTENT
HIGH VOLUME
INTERMEDIATE SPEED TO HIGH SPEED
PRIMARY & SECONDARY ROUTES

MULTILANE SECONDARY AND PRIMARY ROADWAYS

Utilize intermittent mobile operations for these work activities under the following conditions:

Condition 1 - The maximum time duration of a stop is 15 minutes if the work vehicle and/or the shadow vehicle encroach upon a travel lane more than 2 feet or if the work vehicle and shadow vehicle operate within an interior travel lane.

Condition 2 - The maximum time duration of a stop is 30 minutes if the work vehicle and/or the shadow vehicle encroach upon a travel lane 2 feet or less.

During intermittent mobile operations, utilize a shadow vehicle when the stopping sight distance interval between the work vehicle or road machinery and an approaching motorist is unavailable based upon the posted regulatory speed limit of the work location.

Lane closures are required for work activities that cannot be conducted under the conditions required for intermittent mobile operations.

TYPICAL DRAWING APPLICATIONS

LANE CLOSURES

- DRAWING 505-01** - LANE CLOSURE
LOW SPEED MULTILANE
< / = 35 MPH
PRIMARY & SECONDARY ROUTES
- DRAWING 505-02** - DUAL LANE CLOSURE
LOW SPEED MULTILANE
< / = 35 MPH
PRIMARY & SECONDARY ROUTES
- DRAWING 505-03-A** - LANE CLOSURE
INTERMEDIATE SPEED TO HIGH SPEED
40 MPH - 60 MPH
MULTILANE
PRIMARY & SECONDARY ROUTES

- DRAWING 505-04-A** - DUAL LANE CLOSURE
TRANSITION / ACTIVITY AREAS
INTERMEDIATE SPEED TO HIGH SPEED
40 MPH - 60 MPH
MULTILANE
PRIMARY & SECONDARY ROUTES
- DRAWING 505-04-B** - DUAL LANE CLOSURE
ADVANCE WARNING AREA
INTERMEDIATE SPEED TO HIGH SPEED
40 MPH - 60 MPH
MULTILANE
PRIMARY & SECONDARY ROUTES

MOBILE OPERATIONS – INTERMITTENT

- DRAWING 535-01-A** - MOBILE OPERATIONS – INTERMITTENT
STOPPING SIGHT DISTANCE
VEHICLE TRAIN REQUIREMENTS
VERTICAL CURVE (HILL)
- DRAWING 535-01-B** - MOBILE OPERATIONS – INTERMITTENT
STOPPING SIGHT DISTANCE
VEHICLE TRAIN REQUIREMENTS
HORIZONTAL CURVE (CURVE)
- DRAWING 535-03-A** - MOBILE OPERATIONS – INTERMITTENT
INTERMEDIATE VOLUME
LOW SPEED
PRIMARY & SECONDARY ROUTES
- DRAWING 535-03-B** - MOBILE OPERATIONS – INTERMITTENT
INTERMEDIATE VOLUME
INTERMEDIATE SPEED TO HIGH SPEED
PRIMARY & SECONDARY ROUTES
- DRAWING 535-04-A** - MOBILE OPERATIONS – INTERMITTENT
HIGH VOLUME
LOW SPEED
PRIMARY & SECONDARY ROUTES
- DRAWING 535-04-B** - MOBILE OPERATIONS – INTERMITTENT
HIGH VOLUME
LOW SPEED
INTERIOR TRAVEL LANE OPERATIONS
PRIMARY & SECONDARY ROUTES
- DRAWING 535-04-C** - MOBILE OPERATIONS – INTERMITTENT
HIGH VOLUME
INTERMEDIATE SPEED TO HIGH SPEED
PRIMARY & SECONDARY ROUTES

INTERSTATE ROADWAYS

Intermittent mobile operations may be utilized for these work activities under the following conditions:

Condition 1 - The maximum time duration of a stop is 5 minutes if the work vehicle and/or the shadow vehicle encroach upon an adjacent travel lane due to a shoulder area inadequate to accommodate a vehicle in its entirety due to the presence of a concrete median barrier wall or a bridge parapet wall.

Condition 2 - The maximum time duration of a stop is 30 minutes if the vehicles remain in the shoulder areas in their entirety with no encroachment upon an adjacent travel lane.

During intermittent Condition 1 and Condition 2 mobile operations, utilize a shadow vehicle when the stopping sight distance interval between the work vehicle or road machinery and an approaching motorist is unavailable based upon the posted regulatory speed limit of the work location.

UTILIZE DRAWING 535-04-D(2) WHEN PEDESTRIAN WORKERS MUST ENCROACH UPON A TRAVEL LANE AND THE WORK ACTIVITIES CAN BE COMPLETED IN 15 MINUTES OR LESS.

Lane closures are required for work activities that cannot be conducted under the conditions required for intermittent mobile operations. Dual lane closures are required for work activities in the center or interior travel lanes.

TYPICAL DRAWING APPLICATIONS

LANE CLOSURES

DRAWING 510-01-A	-	LANE CLOSURE INTERSTATE ROUTES
DRAWING 510-01-B	-	LANE CLOSURE EXIT / ENTRANCE RAMPS INTERSTATE ROUTES
DRAWING 510-02-A	-	DUAL LANE CLOSURE TRANSITION / ACTIVITY AREAS INTERSTATE ROUTES
DRAWING 510-02-B	-	DUAL LANE CLOSURE ADVANCE WARNING AREA INTERSTATE ROUTES
DRAWING 510-02-C	-	DUAL LANE CLOSURE EXIT / ENTRANCE RAMPS INTERSTATE ROUTES

MOBILIZED SHOULDER OPERATIONS

DRAWING 530-03	-	MOBILIZED SHOULDER OPERATIONS PEDESTRIAN WORKERS – MAJOR ENCROACHMENT UPON PAVED SHOULDER ROAD MACHINERY – MAJOR ENCROACHMENT UPON TRAVEL LANE INTERSTATE ROUTES
-----------------------	---	---

MOBILE OPERATIONS – INTERMITTENT

DRAWING 535-01-A	-	MOBILE OPERATIONS – INTERMITTENT STOPPING SIGHT DISTANCE VEHICLE TRAIN REQUIREMENTS VERTICAL CURVE (HILL)
-------------------------	---	--

- DRAWING 535-01-B** - MOBILE OPERATIONS – INTERMITTENT
STOPPING SIGHT DISTANCE
VEHICLE TRAIN REQUIREMENTS
HORIZONTAL CURVE (CURVE)
- DRAWING 535-04-D(2)** - MOBILE OPERATIONS – INTERMITTENT
PEDESTRIAN WORKERS
INTERSTATE ROUTES
(MAJOR ENCROACHMENT)
- DRAWING 535-04-E** - MOBILE OPERATIONS – INTERMITTENT
HIGH VOLUME
HIGH SPEED
INTERIOR TRAVEL LANE OPERATIONS
INTERSTATE ROUTES

WORK DESCRIPTION 2 Major Leveling / Strengthening

Repair severe depressions and pavement failures through utilization of a paving machine, asphalt spreader, backhoe, or motor grader.

TRAFFIC CONTROL

TWO-LANE TWO-WAY ROADWAYS

Flagging operations are required for these work activities.

TYPICAL DRAWING APPLICATIONS

FLAGGING OPERATIONS

- DRAWING 405-01-A** - FLAGGING OPERATIONS
MULTIPLE FLAGGERS
TWO-LANE TWO-WAY ROADWAYS
PRIMARY & SECONDARY ROUTES
- DRAWING 405-01-B(1)** - FLAGGING OPERATIONS
MULTIPLE FLAGGERS
TWO-LANE TWO-WAY ROADWAYS
PRIMARY & SECONDARY ROUTES
STOP SIGN CONTROLLED SIDE ROADS
- DRAWING 405-01-B(2)** - FLAGGING OPERATIONS
MULTIPLE FLAGGERS
TWO-LANE TWO-WAY ROADWAYS
PRIMARY & SECONDARY ROUTES
4-WAY STOP CONTROLLED INTERSECTION
- DRAWING 405-01-C(1)** - FLAGGING OPERATIONS
MULTIPLE FLAGGERS
TWO-LANE TWO-WAY ROADWAYS
PRIMARY & SECONDARY ROUTES
TRAFFIC SIGNAL CONTROLLED INTERSECTION
LAW ENFORCEMENT OFFICER(S)
- DRAWING 405-01-C(2)** - FLAGGING OPERATIONS
MULTIPLE FLAGGERS
TWO-LANE TWO-WAY ROADWAYS
PRIMARY & SECONDARY ROUTES
TRAFFIC SIGNAL CONTROLLED INTERSECTION
FLAGGERS

- DRAWING 405-01-D(1)** - FLAGGING OPERATIONS
 MULTIPLE FLAGGERS
 TWO-LANE TWO-WAY ROADWAYS
 PRIMARY & SECONDARY ROUTES
 WORK ACTIVITY AREA
 BEGINNING at an
 INTERSECTION with a
 TWO-LANE TWO-WAY ROADWAY
 DEPARTURE LANE
- DRAWING 405-01-D(2)** - FLAGGING OPERATIONS
 MULTIPLE FLAGGERS
 TWO-LANE TWO-WAY ROADWAYS
 PRIMARY & SECONDARY ROUTES
 WORK ACTIVITY AREA
 TERMINATING at an
 INTERSECTION with a
 TWO-LANE TWO-WAY ROADWAY
 APPROACH LANE
- DRAWING 405-01-E(1)**
DRAWING 405-01-E(2) - FLAGGING OPERATIONS
 MULTIPLE FLAGGERS
 TWO-LANE TWO-WAY ROADWAYS
 PRIMARY & SECONDARY ROUTES
 WORK ACTIVITY AREA
 INTERSECTIONS with
 LOW SPEED
 < / = 35 MPH
 MULTILANE ROADWAYS
- DRAWING 405-01-F(1)**
DRAWING 405-01-F(2) - FLAGGING OPERATIONS
 MULTIPLE FLAGGERS
 TWO-LANE TWO-WAY ROADWAYS
 PRIMARY & SECONDARY ROUTES
 WORK ACTIVITY AREA
 INTERSECTIONS with
 INTERMEDIATE SPEED to HIGH SPEED
 40 MPH - 60 MPH
 MULTILANE ROADWAYS
- DRAWING 405-02** - FLAGGING OPERATIONS
 SINGLE FLAGGER OPERATION
 LOW VOLUME
 LOW SPEED TO INTERMEDIATE SPEED
 TWO-LANE TWO-WAY ROADWAYS
 PRIMARY & SECONDARY ROUTES

MULTILANE SECONDARY AND PRIMARY ROADWAYS

Lane closures are required for these work activities.

TYPICAL DRAWING APPLICATIONS

LANE CLOSURES

- DRAWING 505-01** - LANE CLOSURE
 LOW SPEED MULTILANE
 < / = 35 MPH
 PRIMARY & SECONDARY ROUTES
- DRAWING 505-02** - DUAL LANE CLOSURE
 LOW SPEED MULTILANE
 < / = 35 MPH
 PRIMARY & SECONDARY ROUTES

- DRAWING 505-03-A** - LANE CLOSURE
INTERMEDIATE SPEED TO HIGH SPEED
40 MPH - 60 MPH
MULTILANE
PRIMARY & SECONDARY ROUTES
- DRAWING 505-04-A** - DUAL LANE CLOSURE
TRANSITION / ACTIVITY AREAS
INTERMEDIATE SPEED TO HIGH SPEED
40 MPH - 60 MPH
MULTILANE
PRIMARY & SECONDARY ROUTES
- DRAWING 505-04-B** - DUAL LANE CLOSURE
ADVANCE WARNING AREA
INTERMEDIATE SPEED TO HIGH SPEED
40 MPH - 60 MPH
MULTILANE
PRIMARY & SECONDARY ROUTES

INTERSTATE ROADWAYS

Lane closures are required for these work activities.

TYPICAL DRAWING APPLICATIONS

LANE CLOSURES

- DRAWING 510-01-A** - LANE CLOSURE
INTERSTATE ROUTES
- DRAWING 510-01-B** - LANE CLOSURE
EXIT / ENTRANCE RAMPS
INTERSTATE ROUTES
- DRAWING 510-02-A** - DUAL LANE CLOSURE
TRANSITION / ACTIVITY AREAS
INTERSTATE ROUTES
- DRAWING 510-02-B** - DUAL LANE CLOSURE
ADVANCE WARNING AREA
INTERSTATE ROUTES
- DRAWING 510-02-C** - DUAL LANE CLOSURE
EXIT / ENTRANCE RAMPS
INTERSTATE ROUTES

WORK DESCRIPTION 3 Resurface

TRAFFIC CONTROL

TWO-LANE TWO-WAY ROADWAYS

Flagging operations are required for these work activities.

TYPICAL DRAWING APPLICATIONS

FLAGGING OPERATIONS

- DRAWING 405-01-A** - FLAGGING OPERATIONS
MULTIPLE FLAGGERS
TWO-LANE TWO-WAY ROADWAYS
PRIMARY & SECONDARY ROUTES

MULTILANE SECONDARY AND PRIMARY ROADWAYS

Lane closures are required for these work activities.

TYPICAL DRAWING APPLICATIONS

LANE CLOSURES

- | | | |
|-------------------------|---|--|
| DRAWING 505-01 | - | LANE CLOSURE
LOW SPEED MULTILANE
< / = 35 MPH
PRIMARY & SECONDARY ROUTES |
| DRAWING 505-02 | - | DUAL LANE CLOSURE
LOW SPEED MULTILANE
< / = 35 MPH
PRIMARY & SECONDARY ROUTES |
| DRAWING 505-03-A | - | LANE CLOSURE
INTERMEDIATE SPEED TO HIGH SPEED
40 MPH - 60 MPH
MULTILANE
PRIMARY & SECONDARY ROUTES |
| DRAWING 505-04-A | - | DUAL LANE CLOSURE
TRANSITION / ACTIVITY AREAS
INTERMEDIATE SPEED TO HIGH SPEED
40 MPH - 60 MPH
MULTILANE
PRIMARY & SECONDARY ROUTES |
| DRAWING 505-04-B | - | DUAL LANE CLOSURE
ADVANCE WARNING AREA
INTERMEDIATE SPEED TO HIGH SPEED
40 MPH - 60 MPH
MULTILANE
PRIMARY & SECONDARY ROUTES |

INTERSTATE ROADWAYS

Lane closures are required for these work activities.

TYPICAL DRAWING APPLICATIONS

LANE CLOSURES

- | | | |
|-------------------------|---|---|
| DRAWING 510-01-A | - | LANE CLOSURE
INTERSTATE ROUTES |
| DRAWING 510-01-B | - | LANE CLOSURE
EXIT / ENTRANCE RAMPS
INTERSTATE ROUTES |
| DRAWING 510-02-A | - | DUAL LANE CLOSURE
TRANSITION / ACTIVITY AREAS
INTERSTATE ROUTES |
| DRAWING 510-02-B | - | DUAL LANE CLOSURE
ADVANCE WARNING AREA
INTERSTATE ROUTES |
| DRAWING 510-02-C | - | DUAL LANE CLOSURE
EXIT / ENTRANCE RAMPS
INTERSTATE ROUTES |

PERFORMANCE ACTIVITY 107

CHIP SEAL

WORK DESCRIPTION 1	Single
WORK DESCRIPTION 2	Double
WORK DESCRIPTION 3	Triple

107 CHIP SEAL

ACTIVITY DESCRIPTION

Maintain the roadway wearing surface through application of one or more layers of a polymer modified cationic emulsion (CRS-2P) followed by a layer of aggregate.

- WORK DESCRIPTION 1 Single**
- WORK DESCRIPTION 2 Double**
- WORK DESCRIPTION 3 Triple**

TRAFFIC CONTROL

TWO-LANE TWO-WAY ROADWAYS

Flagging operations are required for these work activities.

TYPICAL DRAWING APPLICATIONS

FLAGGING OPERATIONS

- DRAWING 405-01-A** - FLAGGING OPERATIONS
MULTIPLE FLAGGERS
TWO-LANE TWO-WAY ROADWAYS
PRIMARY & SECONDARY ROUTES
- DRAWING 405-01-B(1)** - FLAGGING OPERATIONS
MULTIPLE FLAGGERS
TWO-LANE TWO-WAY ROADWAYS
PRIMARY & SECONDARY ROUTES
STOP SIGN CONTROLLED SIDE ROADS
- DRAWING 405-01-B(2)** - FLAGGING OPERATIONS
MULTIPLE FLAGGERS
TWO-LANE TWO-WAY ROADWAYS
PRIMARY & SECONDARY ROUTES
4-WAY STOP CONTROLLED INTERSECTION
- DRAWING 405-01-C(1)** - FLAGGING OPERATIONS
MULTIPLE FLAGGERS
TWO-LANE TWO-WAY ROADWAYS
PRIMARY & SECONDARY ROUTES
TRAFFIC SIGNAL CONTROLLED INTERSECTION
LAW ENFORCEMENT OFFICER(S)
- DRAWING 405-01-C(2)** - FLAGGING OPERATIONS
MULTIPLE FLAGGERS
TWO-LANE TWO-WAY ROADWAYS
PRIMARY & SECONDARY ROUTES
TRAFFIC SIGNAL CONTROLLED INTERSECTION
FLAGGERS
- DRAWING 405-01-D(1)** - FLAGGING OPERATIONS
MULTIPLE FLAGGERS
TWO-LANE TWO-WAY ROADWAYS
PRIMARY & SECONDARY ROUTES
WORK ACTIVITY AREA
BEGINNING at an
INTERSECTION with a
TWO-LANE TWO-WAY ROADWAY
DEPARTURE LANE

- DRAWING 405-01-D(2)** - FLAGGING OPERATIONS
MULTIPLE FLAGGERS
TWO-LANE TWO-WAY ROADWAYS
PRIMARY & SECONDARY ROUTES
WORK ACTIVITY AREA
TERMINATING at an
INTERSECTION with a
TWO-LANE TWO-WAY ROADWAY
APPROACH LANE

- DRAWING 405-01-E(1)**
DRAWING 405-01-E(2) - FLAGGING OPERATIONS
MULTIPLE FLAGGERS
TWO-LANE TWO-WAY ROADWAYS
PRIMARY & SECONDARY ROUTES
WORK ACTIVITY AREA
INTERSECTIONS with
LOW SPEED
< / = 35 MPH
MULTILANE ROADWAYS

- DRAWING 405-01-F(1)**
DRAWING 405-01-F(2) - FLAGGING OPERATIONS
MULTIPLE FLAGGERS
TWO-LANE TWO-WAY ROADWAYS
PRIMARY & SECONDARY ROUTES
WORK ACTIVITY AREA
INTERSECTIONS with
INTERMEDIATE SPEED to HIGH SPEED
40 MPH - 60 MPH
MULTILANE ROADWAYS

- DRAWING 405-02** - FLAGGING OPERATIONS
SINGLE FLAGGER OPERATION
LOW VOLUME
LOW SPEED TO INTERMEDIATE SPEED
TWO-LANE TWO-WAY ROADWAYS
PRIMARY & SECONDARY ROUTES

MULTILANE SECONDARY AND PRIMARY ROADWAYS

Lane closures are required for these work activities.

TYPICAL DRAWING APPLICATIONS

LANE CLOSURES

- DRAWING 505-01** - LANE CLOSURE
LOW SPEED MULTILANE
< / = 35 MPH
PRIMARY & SECONDARY ROUTES

- DRAWING 505-02** - DUAL LANE CLOSURE
LOW SPEED MULTILANE
< / = 35 MPH
PRIMARY & SECONDARY ROUTES

- DRAWING 505-03-A** - LANE CLOSURE
INTERMEDIATE SPEED TO HIGH SPEED
40 MPH - 60 MPH
MULTILANE
PRIMARY & SECONDARY ROUTES

- DRAWING 505-04-A** - DUAL LANE CLOSURE
TRANSITION / ACTIVITY AREAS
INTERMEDIATE SPEED TO HIGH SPEED
40 MPH - 60 MPH
MULTILANE
PRIMARY & SECONDARY ROUTES
- DRAWING 505-04-B** - DUAL LANE CLOSURE
ADVANCE WARNING AREA
INTERMEDIATE SPEED TO HIGH SPEED
40 MPH - 60 MPH
MULTILANE
PRIMARY & SECONDARY ROUTES

INTERSTATE ROADWAYS

Lane closures are required for these work activities.

TYPICAL DRAWING APPLICATIONS

LANE CLOSURES

- DRAWING 510-01-A** - LANE CLOSURE
INTERSTATE ROUTES
- DRAWING 510-01-B** - LANE CLOSURE
EXIT / ENTRANCE RAMPS
INTERSTATE ROUTES
- DRAWING 510-02-A** - DUAL LANE CLOSURE
TRANSITION / ACTIVITY AREAS
INTERSTATE ROUTES
- DRAWING 510-02-B** - DUAL LANE CLOSURE
ADVANCE WARNING AREA
INTERSTATE ROUTES
- DRAWING 510-02-C** - DUAL LANE CLOSURE
EXIT / ENTRANCE RAMPS
INTERSTATE ROUTES

PERFORMANCE ACTIVITY 108

MILLING

ACTIVITY DESCRIPTION

Remove pavement irregularities and restore a smooth riding surface through utilization of a milling machine.

TRAFFIC CONTROL

TWO-LANE TWO-WAY ROADWAYS

Flagging operations are required for these work activities.

TYPICAL DRAWING APPLICATIONS

FLAGGING OPERATIONS

- DRAWING 405-01-A** - FLAGGING OPERATIONS
MULTIPLE FLAGGERS
TWO-LANE TWO-WAY ROADWAYS
PRIMARY & SECONDARY ROUTES
- DRAWING 405-01-B(1)** - FLAGGING OPERATIONS
MULTIPLE FLAGGERS
TWO-LANE TWO-WAY ROADWAYS
PRIMARY & SECONDARY ROUTES
STOP SIGN CONTROLLED SIDE ROADS
- DRAWING 405-01-B(2)** - FLAGGING OPERATIONS
MULTIPLE FLAGGERS
TWO-LANE TWO-WAY ROADWAYS
PRIMARY & SECONDARY ROUTES
4-WAY STOP CONTROLLED INTERSECTION
- DRAWING 405-01-C(1)** - FLAGGING OPERATIONS
MULTIPLE FLAGGERS
TWO-LANE TWO-WAY ROADWAYS
PRIMARY & SECONDARY ROUTES
TRAFFIC SIGNAL CONTROLLED INTERSECTION
LAW ENFORCEMENT OFFICER(S)
- DRAWING 405-01-C(2)** - FLAGGING OPERATIONS
MULTIPLE FLAGGERS
TWO-LANE TWO-WAY ROADWAYS
PRIMARY & SECONDARY ROUTES
TRAFFIC SIGNAL CONTROLLED INTERSECTION
FLAGGERS
- DRAWING 405-01-D(1)** - FLAGGING OPERATIONS
MULTIPLE FLAGGERS
TWO-LANE TWO-WAY ROADWAYS
PRIMARY & SECONDARY ROUTES
WORK ACTIVITY AREA
BEGINNING at an
INTERSECTION with a
TWO-LANE TWO-WAY ROADWAY
DEPARTURE LANE
- DRAWING 405-01-D(2)** - FLAGGING OPERATIONS
MULTIPLE FLAGGERS
TWO-LANE TWO-WAY ROADWAYS
PRIMARY & SECONDARY ROUTES
WORK ACTIVITY AREA
TERMINATING at an
INTERSECTION with a
TWO-LANE TWO-WAY ROADWAY
APPROACH LANE

- DRAWING 405-01-E(1)**
- DRAWING 405-01-E(2)** - FLAGGING OPERATIONS
MULTIPLE FLAGGERS
TWO-LANE TWO-WAY ROADWAYS
PRIMARY & SECONDARY ROUTES
WORK ACTIVITY AREA
INTERSECTIONS with
LOW SPEED
< / = 35 MPH
MULTILANE ROADWAYS

- DRAWING 405-01-F(1)**
- DRAWING 405-01-F(2)** - FLAGGING OPERATIONS
MULTIPLE FLAGGERS
TWO-LANE TWO-WAY ROADWAYS
PRIMARY & SECONDARY ROUTES
WORK ACTIVITY AREA
INTERSECTIONS with
INTERMEDIATE SPEED to HIGH SPEED
40 MPH - 60 MPH
MULTILANE ROADWAYS

- DRAWING 405-02** - FLAGGING OPERATIONS
SINGLE FLAGGER OPERATION
LOW VOLUME
LOW SPEED TO INTERMEDIATE SPEED
TWO-LANE TWO-WAY ROADWAYS
PRIMARY & SECONDARY ROUTES

MULTILANE SECONDARY AND PRIMARY ROADWAYS

Lane closures are required for these work activities.

TYPICAL DRAWING APPLICATIONS

LANE CLOSURES

- DRAWING 505-01** - LANE CLOSURE
LOW SPEED MULTILANE
< / = 35 MPH
PRIMARY & SECONDARY ROUTES

- DRAWING 505-02** - DUAL LANE CLOSURE
LOW SPEED MULTILANE
< / = 35 MPH
PRIMARY & SECONDARY ROUTES

- DRAWING 505-03-A** - LANE CLOSURE
INTERMEDIATE SPEED TO HIGH SPEED
40 MPH - 60 MPH
MULTILANE
PRIMARY & SECONDARY ROUTES

- DRAWING 505-04-A** - DUAL LANE CLOSURE
TRANSITION / ACTIVITY AREAS
INTERMEDIATE SPEED TO HIGH SPEED
40 MPH - 60 MPH
MULTILANE
PRIMARY & SECONDARY ROUTES

- DRAWING 505-04-B** - DUAL LANE CLOSURE
ADVANCE WARNING AREA
INTERMEDIATE SPEED TO HIGH SPEED
40 MPH - 60 MPH
MULTILANE
PRIMARY & SECONDARY ROUTES

INTERSTATE ROADWAYS

Lane closures are required for these work activities.

TYPICAL DRAWING APPLICATIONS

LANE CLOSURES

DRAWING 510-01-A	-	LANE CLOSURE INTERSTATE ROUTES
DRAWING 510-01-B	-	LANE CLOSURE EXIT / ENTRANCE RAMPS INTERSTATE ROUTES
DRAWING 510-02-A	-	DUAL LANE CLOSURE TRANSITION / ACTIVITY AREAS INTERSTATE ROUTES
DRAWING 510-02-B	-	DUAL LANE CLOSURE ADVANCE WARNING AREA INTERSTATE ROUTES
DRAWING 510-02-C	-	DUAL LANE CLOSURE EXIT / ENTRANCE RAMPS INTERSTATE ROUTES

PERFORMANCE ACTIVITY 110

BASE REPAIR

WORK DESCRIPTION 1	Full Depth Asphalt
WORK DESCRIPTION 2	Full Depth Concrete
WORK DESCRIPTION 3	Reclamation

110 BASE REPAIR

ACTIVITY DESCRIPTION

Repair the base or sub-grade failures with suitable material to include the paved surface.

WORK DESCRIPTION 1 Full Depth Asphalt
WORK DESCRIPTION 2 Full Depth Concrete

TRAFFIC CONTROL

TWO-LANE TWO-WAY ROADWAYS

Flagging operations are required for these work activities.

TYPICAL DRAWING APPLICATIONS

FLAGGING OPERATIONS

DRAWING 405-01-A	-	FLAGGING OPERATIONS MULTIPLE FLAGGERS TWO-LANE TWO-WAY ROADWAYS PRIMARY & SECONDARY ROUTES
DRAWING 405-01-B(1)	-	FLAGGING OPERATIONS MULTIPLE FLAGGERS TWO-LANE TWO-WAY ROADWAYS PRIMARY & SECONDARY ROUTES STOP SIGN CONTROLLED SIDE ROADS
DRAWING 405-01-B(2)	-	FLAGGING OPERATIONS MULTIPLE FLAGGERS TWO-LANE TWO-WAY ROADWAYS PRIMARY & SECONDARY ROUTES 4-WAY STOP CONTROLLED INTERSECTION
DRAWING 405-01-C(1)	-	FLAGGING OPERATIONS MULTIPLE FLAGGERS TWO-LANE TWO-WAY ROADWAYS PRIMARY & SECONDARY ROUTES TRAFFIC SIGNAL CONTROLLED INTERSECTION LAW ENFORCEMENT OFFICER(S)
DRAWING 405-01-C(2)	-	FLAGGING OPERATIONS MULTIPLE FLAGGERS TWO-LANE TWO-WAY ROADWAYS PRIMARY & SECONDARY ROUTES TRAFFIC SIGNAL CONTROLLED INTERSECTION FLAGGERS
DRAWING 405-01-D(1)	-	FLAGGING OPERATIONS MULTIPLE FLAGGERS TWO-LANE TWO-WAY ROADWAYS PRIMARY & SECONDARY ROUTES WORK ACTIVITY AREA BEGINNING at an INTERSECTION with a TWO-LANE TWO-WAY ROADWAY DEPARTURE LANE

- DRAWING 405-01-D(2)** - FLAGGING OPERATIONS
MULTIPLE FLAGGERS
TWO-LANE TWO-WAY ROADWAYS
PRIMARY & SECONDARY ROUTES
WORK ACTIVITY AREA
TERMINATING at an
INTERSECTION with a
TWO-LANE TWO-WAY ROADWAY
APPROACH LANE

- DRAWING 405-01-E(1)**
DRAWING 405-01-E(2) - FLAGGING OPERATIONS
MULTIPLE FLAGGERS
TWO-LANE TWO-WAY ROADWAYS
PRIMARY & SECONDARY ROUTES
WORK ACTIVITY AREA
INTERSECTIONS with
LOW SPEED
< / = 35 MPH
MULTILANE ROADWAYS

- DRAWING 405-01-F(1)**
DRAWING 405-01-F(2) - FLAGGING OPERATIONS
MULTIPLE FLAGGERS
TWO-LANE TWO-WAY ROADWAYS
PRIMARY & SECONDARY ROUTES
WORK ACTIVITY AREA
INTERSECTIONS with
INTERMEDIATE SPEED to HIGH SPEED
40 MPH - 60 MPH
MULTILANE ROADWAYS

- DRAWING 405-02** - FLAGGING OPERATIONS
SINGLE FLAGGER OPERATION
LOW VOLUME
LOW SPEED TO INTERMEDIATE SPEED
TWO-LANE TWO-WAY ROADWAYS
PRIMARY & SECONDARY ROUTES

MULTILANE SECONDARY AND PRIMARY ROADWAYS

Lane closures are required for these work activities.

TYPICAL DRAWING APPLICATIONS

LANE CLOSURES

- DRAWING 505-01** - LANE CLOSURE
LOW SPEED MULTILANE
< / = 35 MPH
PRIMARY & SECONDARY ROUTES

- DRAWING 505-02** - DUAL LANE CLOSURE
LOW SPEED MULTILANE
< / = 35 MPH
PRIMARY & SECONDARY ROUTES

- DRAWING 505-03-A** - LANE CLOSURE
INTERMEDIATE SPEED TO HIGH SPEED
40 MPH - 60 MPH
MULTILANE
PRIMARY & SECONDARY ROUTES

- | | | |
|-------------------------|---|--|
| DRAWING 505-04-A | - | DUAL LANE CLOSURE
TRANSITION / ACTIVITY AREAS
INTERMEDIATE SPEED TO HIGH SPEED
40 MPH - 60 MPH
MULTILANE
PRIMARY & SECONDARY ROUTES |
| DRAWING 505-04-B | - | DUAL LANE CLOSURE
ADVANCE WARNING AREA
INTERMEDIATE SPEED TO HIGH SPEED
40 MPH - 60 MPH
MULTILANE
PRIMARY & SECONDARY ROUTES |

INTERSTATE ROADWAYS

Lane closures are required for these work activities.

TYPICAL DRAWING APPLICATIONS

LANE CLOSURES

- | | | |
|-------------------------|---|---|
| DRAWING 510-01-A | - | LANE CLOSURE
INTERSTATE ROUTES |
| DRAWING 510-01-B | - | LANE CLOSURE
EXIT / ENTRANCE RAMPS
INTERSTATE ROUTES |
| DRAWING 510-02-A | - | DUAL LANE CLOSURE
TRANSITION / ACTIVITY AREAS
INTERSTATE ROUTES |
| DRAWING 510-02-B | - | DUAL LANE CLOSURE
ADVANCE WARNING AREA
INTERSTATE ROUTES |
| DRAWING 510-02-C | - | DUAL LANE CLOSURE
EXIT / ENTRANCE RAMPS
INTERSTATE ROUTES |

WORK DESCRIPTION 3 Reclamation

TRAFFIC CONTROL

TWO-LANE TWO-WAY ROADWAYS

Flagging operations are required for work activities that require equipment, personnel, materials, or any vehicles to encroach upon a travel lane or a shoulder area of a bridge or a bridge approach.

When determined necessary, install and maintain road closures and traffic detours for these work activities.

TYPICAL DRAWING APPLICATIONS

FLAGGING OPERATIONS

- DRAWING 405-01-A** - FLAGGING OPERATIONS
MULTIPLE FLAGGERS
TWO-LANE TWO-WAY ROADWAYS
PRIMARY & SECONDARY ROUTES

- DRAWING 405-01-B(1)** - FLAGGING OPERATIONS
MULTIPLE FLAGGERS
TWO-LANE TWO-WAY ROADWAYS
PRIMARY & SECONDARY ROUTES
STOP SIGN CONTROLLED SIDE ROADS

- DRAWING 405-01-B(2)** - FLAGGING OPERATIONS
MULTIPLE FLAGGERS
TWO-LANE TWO-WAY ROADWAYS
PRIMARY & SECONDARY ROUTES
4-WAY STOP CONTROLLED INTERSECTION

- DRAWING 405-01-C(1)** - FLAGGING OPERATIONS
MULTIPLE FLAGGERS
TWO-LANE TWO-WAY ROADWAYS
PRIMARY & SECONDARY ROUTES
TRAFFIC SIGNAL CONTROLLED INTERSECTION
LAW ENFORCEMENT OFFICER(S)

- DRAWING 405-01-C(2)** - FLAGGING OPERATIONS
MULTIPLE FLAGGERS
TWO-LANE TWO-WAY ROADWAYS
PRIMARY & SECONDARY ROUTES
TRAFFIC SIGNAL CONTROLLED INTERSECTION
FLAGGERS

- DRAWING 405-01-D(1)** - FLAGGING OPERATIONS
MULTIPLE FLAGGERS
TWO-LANE TWO-WAY ROADWAYS
PRIMARY & SECONDARY ROUTES
WORK ACTIVITY AREA
BEGINNING at an
INTERSECTION with a
TWO-LANE TWO-WAY ROADWAY
DEPARTURE LANE

- DRAWING 405-01-D(2)** - FLAGGING OPERATIONS
MULTIPLE FLAGGERS
TWO-LANE TWO-WAY ROADWAYS
PRIMARY & SECONDARY ROUTES
WORK ACTIVITY AREA
TERMINATING at an
INTERSECTION with a
TWO-LANE TWO-WAY ROADWAY
APPROACH LANE

- DRAWING 405-01-E(1)
- DRAWING 405-01-E(2) - FLAGGING OPERATIONS
MULTIPLE FLAGGERS
TWO-LANE TWO-WAY ROADWAYS
PRIMARY & SECONDARY ROUTES
WORK ACTIVITY AREA
INTERSECTIONS with
LOW SPEED
< / = 35 MPH
MULTILANE ROADWAYS
- DRAWING 405-01-F(1)
- DRAWING 405-01-F(2) - FLAGGING OPERATIONS
MULTIPLE FLAGGERS
TWO-LANE TWO-WAY ROADWAYS
PRIMARY & SECONDARY ROUTES
WORK ACTIVITY AREA
INTERSECTIONS with
INTERMEDIATE SPEED to HIGH SPEED
40 MPH - 60 MPH
MULTILANE ROADWAYS

ROAD CLOSURE

- DRAWING 705-02 - EXTENDED ROAD CLOSURE
FOR
BRIDGE WORK

DETOUR SIGNING

- DRAWING 805-01 - DETOUR SIGNING
FOR
PRIMARY & INTERSTATE ROUTES
- DRAWING 805-02 - DETOUR SIGNING
FOR
SECONDARY ROUTES

MULTILANE SECONDARY AND PRIMARY ROADWAYS

Lane closures are required for work activities that require equipment, personnel, materials, or any vehicles to encroach upon a travel lane or a shoulder area of a bridge or a bridge approach.

When determined necessary, install and maintain road closures and traffic detours for these work activities.

TYPICAL DRAWING APPLICATIONS

LANE CLOSURES

- DRAWING 505-01 - LANE CLOSURE
LOW SPEED MULTILANE
< / = 35 MPH
PRIMARY & SECONDARY ROUTES
- DRAWING 505-03-A - LANE CLOSURE
INTERMEDIATE SPEED TO HIGH SPEED
40 MPH - 60 MPH
MULTILANE
PRIMARY & SECONDARY ROUTES

ROAD CLOSURE

- DRAWING 705-02 - EXTENDED ROAD CLOSURE
FOR
BRIDGE WORK

DETOUR SIGNING

- DRAWING 805-01** - DETOUR SIGNING
FOR
PRIMARY & INTERSTATE ROUTES
- DRAWING 805-02** - DETOUR SIGNING
FOR
SECONDARY ROUTES

INTERSTATE ROADWAYS

Lane closures are required for these work activities.

TYPICAL DRAWING APPLICATIONS

LANE CLOSURES

- DRAWING 510-01-A** - LANE CLOSURE
INTERSTATE ROUTES
- DRAWING 510-01-B** - LANE CLOSURE
EXIT / ENTRANCE RAMPS
INTERSTATE ROUTES
- DRAWING 510-02-A** - DUAL LANE CLOSURE
TRANSITION / ACTIVITY AREAS
INTERSTATE ROUTES
- DRAWING 510-02-B** - DUAL LANE CLOSURE
ADVANCE WARNING AREA
INTERSTATE ROUTES
- DRAWING 510-02-C** - DUAL LANE CLOSURE
EXIT / ENTRANCE RAMPS
INTERSTATE ROUTES

PERFORMANCE ACTIVITY 120

CRACK SEAL PAVEMENT

WORK DESCRIPTION 1
WORK DESCRIPTION 2

Asphalt
Concrete

120 CRACK SEAL PAVEMENT

ACTIVITY DESCRIPTION

Clean and seal cracks in pavement.

WORK DESCRIPTION 1 Asphalt
WORK DESCRIPTION 2 Concrete

TRAFFIC CONTROL

TWO-LANE TWO-WAY ROADWAYS

Flagging operations are required for these work activities.

TYPICAL DRAWING APPLICATIONS

FLAGGING OPERATIONS

DRAWING 405-01-A	-	FLAGGING OPERATIONS MULTIPLE FLAGGERS TWO-LANE TWO-WAY ROADWAYS PRIMARY & SECONDARY ROUTES
DRAWING 405-01-B(1)	-	FLAGGING OPERATIONS MULTIPLE FLAGGERS TWO-LANE TWO-WAY ROADWAYS PRIMARY & SECONDARY ROUTES STOP SIGN CONTROLLED SIDE ROADS
DRAWING 405-01-B(2)	-	FLAGGING OPERATIONS MULTIPLE FLAGGERS TWO-LANE TWO-WAY ROADWAYS PRIMARY & SECONDARY ROUTES 4-WAY STOP CONTROLLED INTERSECTION
DRAWING 405-01-C(1)	-	FLAGGING OPERATIONS MULTIPLE FLAGGERS TWO-LANE TWO-WAY ROADWAYS PRIMARY & SECONDARY ROUTES TRAFFIC SIGNAL CONTROLLED INTERSECTION LAW ENFORCEMENT OFFICER(S)
DRAWING 405-01-C(2)	-	FLAGGING OPERATIONS MULTIPLE FLAGGERS TWO-LANE TWO-WAY ROADWAYS PRIMARY & SECONDARY ROUTES TRAFFIC SIGNAL CONTROLLED INTERSECTION FLAGGERS
DRAWING 405-01-D(1)	-	FLAGGING OPERATIONS MULTIPLE FLAGGERS TWO-LANE TWO-WAY ROADWAYS PRIMARY & SECONDARY ROUTES WORK ACTIVITY AREA BEGINNING at an INTERSECTION with a TWO-LANE TWO-WAY ROADWAY DEPARTURE LANE

- DRAWING 405-01-D(2)** - FLAGGING OPERATIONS
MULTIPLE FLAGGERS
TWO-LANE TWO-WAY ROADWAYS
PRIMARY & SECONDARY ROUTES
WORK ACTIVITY AREA
TERMINATING at an
INTERSECTION with a
TWO-LANE TWO-WAY ROADWAY
APPROACH LANE

- DRAWING 405-01-E(1)**
DRAWING 405-01-E(2) - FLAGGING OPERATIONS
MULTIPLE FLAGGERS
TWO-LANE TWO-WAY ROADWAYS
PRIMARY & SECONDARY ROUTES
WORK ACTIVITY AREA
INTERSECTIONS with
LOW SPEED
< / = 35 MPH
MULTILANE ROADWAYS

- DRAWING 405-01-F(1)**
DRAWING 405-01-F(2) - FLAGGING OPERATIONS
MULTIPLE FLAGGERS
TWO-LANE TWO-WAY ROADWAYS
PRIMARY & SECONDARY ROUTES
WORK ACTIVITY AREA
INTERSECTIONS with
INTERMEDIATE SPEED to HIGH SPEED
40 MPH - 60 MPH
MULTILANE ROADWAYS

- DRAWING 405-02** - FLAGGING OPERATIONS
SINGLE FLAGGER OPERATION
LOW VOLUME
LOW SPEED TO INTERMEDIATE SPEED
TWO-LANE TWO-WAY ROADWAYS
PRIMARY & SECONDARY ROUTES

MULTILANE SECONDARY AND PRIMARY ROADWAYS

Lane closures are required for these work activities.

TYPICAL DRAWING APPLICATIONS

LANE CLOSURES

- DRAWING 505-01** - LANE CLOSURE
LOW SPEED MULTILANE
< / = 35 MPH
PRIMARY & SECONDARY ROUTES

- DRAWING 505-02** - DUAL LANE CLOSURE
LOW SPEED MULTILANE
< / = 35 MPH
PRIMARY & SECONDARY ROUTES

- DRAWING 505-03-A** - LANE CLOSURE
INTERMEDIATE SPEED TO HIGH SPEED
40 MPH - 60 MPH
MULTILANE
PRIMARY & SECONDARY ROUTES

- DRAWING 505-04-A** - DUAL LANE CLOSURE
TRANSITION / ACTIVITY AREAS
INTERMEDIATE SPEED TO HIGH SPEED
40 MPH - 60 MPH
MULTILANE
PRIMARY & SECONDARY ROUTES
- DRAWING 505-04-B** - DUAL LANE CLOSURE
ADVANCE WARNING AREA
INTERMEDIATE SPEED TO HIGH SPEED
40 MPH - 60 MPH
MULTILANE
PRIMARY & SECONDARY ROUTES

INTERSTATE ROADWAYS

Lane closures are required for these work activities.

TYPICAL DRAWING APPLICATIONS

LANE CLOSURES

- DRAWING 510-01-A** - LANE CLOSURE
INTERSTATE ROUTES
- DRAWING 510-01-B** - LANE CLOSURE
EXIT / ENTRANCE RAMPS
INTERSTATE ROUTES
- DRAWING 510-02-A** - DUAL LANE CLOSURE
TRANSITION / ACTIVITY AREAS
INTERSTATE ROUTES
- DRAWING 510-02-B** - DUAL LANE CLOSURE
ADVANCE WARNING AREA
INTERSTATE ROUTES
- DRAWING 510-02-C** - DUAL LANE CLOSURE
EXIT / ENTRANCE RAMPS
INTERSTATE ROUTES

MOBILIZED SHOULDER OPERATIONS

- DRAWING 530-03** - MOBILIZED SHOULDER OPERATIONS
PEDESTRIAN WORKERS – MAJOR ENCROACHMENT
UPON PAVED SHOULDER
ROAD MACHINERY – MAJOR ENCROACHMENT
UPON TRAVEL LANE
INTERSTATE ROUTES

PERFORMANCE ACTIVITY 130

EARTH ROADS

WORK DESCRIPTION 1
WORK DESCRIPTION 2

Machining Earth Roads
Dust Control

130 EARTH ROADS

ACTIVITY DESCRIPTION

Maintain earth roads.

WORK DESCRIPTION 1 Machining Earth Roads

WORK DESCRIPTION 2 Dust Control

TRAFFIC CONTROL

TWO-LANE TWO-WAY EARTH ROADWAYS

Install the advance warning sign "Road Work Ahead" (WC20-1-48-A) at each end of the road or road segment.

Utilize intermittent mobile operations for these work activities.

Use a shadow should when the work vehicle or road machinery must make frequent "backing" movements to conduct the work.

Flagging operations are required for work activities that cannot be conducted under the conditions specified above for intermittent mobile operations.

TYPICAL DRAWING APPLICATIONS

FLAGGING OPERATIONS

- | | | |
|----------------------------|---|--|
| DRAWING 405-01-A | - | FLAGGING OPERATIONS
MULTIPLE FLAGGERS
TWO-LANE TWO-WAY ROADWAYS
PRIMARY & SECONDARY ROUTES |
| DRAWING 405-01-B(1) | - | FLAGGING OPERATIONS
MULTIPLE FLAGGERS
TWO-LANE TWO-WAY ROADWAYS
PRIMARY & SECONDARY ROUTES
STOP SIGN CONTROLLED SIDE ROADS |
| DRAWING 405-01-B(2) | - | FLAGGING OPERATIONS
MULTIPLE FLAGGERS
TWO-LANE TWO-WAY ROADWAYS
PRIMARY & SECONDARY ROUTES
4-WAY STOP CONTROLLED INTERSECTION |
| DRAWING 405-01-D(1) | - | FLAGGING OPERATIONS
MULTIPLE FLAGGERS
TWO-LANE TWO-WAY ROADWAYS
PRIMARY & SECONDARY ROUTES
WORK ACTIVITY AREA
BEGINNING at an
INTERSECTION with a
TWO-LANE TWO-WAY ROADWAY
DEPARTURE LANE |
| DRAWING 405-01-D(2) | - | FLAGGING OPERATIONS
MULTIPLE FLAGGERS
TWO-LANE TWO-WAY ROADWAYS
PRIMARY & SECONDARY ROUTES
WORK ACTIVITY AREA
TERMINATING at an
INTERSECTION with a
TWO-LANE TWO-WAY ROADWAY
APPROACH LANE |

MOBILE OPERATIONS – INTERMITTENT

- DRAWING 535-01-A** - MOBILE OPERATIONS – INTERMITTENT
STOPPING SIGHT DISTANCE
VEHICLE TRAIN REQUIREMENTS
VERTICAL CURVE (HILL)

- DRAWING 535-01-B** - MOBILE OPERATIONS – INTERMITTENT
STOPPING SIGHT DISTANCE
VEHICLE TRAIN REQUIREMENTS
HORIZONTAL CURVE (CURVE)

- DRAWING 535-02-A** - MOBILE OPERATIONS – INTERMITTENT
LOW VOLUME
LOW SPEED
PRIMARY & SECONDARY ROUTES

PERFORMANCE ACTIVITY 202

SLOPES

WORK DESCRIPTION 1
WORK DESCRIPTION 2

Repair
Install / Maintain

ACTIVITY DESCRIPTION

Repair washouts and slides on slopes and shoulders. Haul necessary materials and place silt fence, ditch checks, erosion control measures and grass seed to prevent erosion.

WORK DESCRIPTION 1 Repair

WORK DESCRIPTION 2 Install / Maintain

TRAFFIC CONTROL

TWO-LANE TWO-WAY ROADWAYS

Mobilized shoulder operations may be used for work activities that progress along the roadway at a slow pace and require road machinery operating on the shoulder to encroach upon the roadway.

On low speed roadways with speeds of 35 mph or less, shoulder closures designed for minor encroachment are acceptable for work activities conducted within 30 feet of the near edge of an adjacent travel lane that may require encroachment upon the roadway by personnel, tools, equipment, materials, vehicles, etc. to the extent that may require a reduction of the lane width of an adjacent travel lane to no less than 10 feet.

On low speed roadways with speeds of 35 mph or less, standard shoulder closures are required for work activities that require the presence of personnel, tools, equipment, materials, vehicles, etc. beyond 1 foot but within 30 feet of the near edge of an adjacent travel lane.

On intermediate to high speed roadways, standard shoulder closures are required for work activities that require the presence of personnel, tools, equipment, materials, vehicles, etc. beyond 1 foot but within 30 feet of the near edge of an adjacent travel lane.

On intermediate to high speed roadways, flagging operations are required when the work activities require the presence of personnel, tools, equipment, materials, vehicles, etc. to encroach upon the roadway or to within 1 foot of the near edge of an adjacent travel lane.

Flagging operations are required for work activities that cannot be conducted under the conditions required for standard shoulder closures, shoulder closures with minor encroachment or mobilized shoulder operations.

TYPICAL DRAWING APPLICATIONS

FLAGGING OPERATIONS

- DRAWING 405-01-A** - FLAGGING OPERATIONS
MULTIPLE FLAGGERS
TWO-LANE TWO-WAY ROADWAYS
PRIMARY & SECONDARY ROUTES
- DRAWING 405-01-B(1)** - FLAGGING OPERATIONS
MULTIPLE FLAGGERS
TWO-LANE TWO-WAY ROADWAYS
PRIMARY & SECONDARY ROUTES
STOP SIGN CONTROLLED SIDE ROADS
- DRAWING 405-01-B(2)** - FLAGGING OPERATIONS
MULTIPLE FLAGGERS
TWO-LANE TWO-WAY ROADWAYS
PRIMARY & SECONDARY ROUTES
4-WAY STOP CONTROLLED INTERSECTION
- DRAWING 405-01-C(1)** - FLAGGING OPERATIONS
MULTIPLE FLAGGERS
TWO-LANE TWO-WAY ROADWAYS
PRIMARY & SECONDARY ROUTES
TRAFFIC SIGNAL CONTROLLED INTERSECTION
LAW ENFORCEMENT OFFICER(S)

DRAWING 405-01-C(2) - FLAGGING OPERATIONS
MULTIPLE FLAGGERS
TWO-LANE TWO-WAY ROADWAYS
PRIMARY & SECONDARY ROUTES
TRAFFIC SIGNAL CONTROLLED INTERSECTION
FLAGGERS

DRAWING 405-01-D(1) - FLAGGING OPERATIONS
MULTIPLE FLAGGERS
TWO-LANE TWO-WAY ROADWAYS
PRIMARY & SECONDARY ROUTES
WORK ACTIVITY AREA
BEGINNING at an
INTERSECTION with a
TWO-LANE TWO-WAY ROADWAY
DEPARTURE LANE

DRAWING 405-01-D(2) - FLAGGING OPERATIONS
MULTIPLE FLAGGERS
TWO-LANE TWO-WAY ROADWAYS
PRIMARY & SECONDARY ROUTES
WORK ACTIVITY AREA
TERMINATING at an
INTERSECTION with a
TWO-LANE TWO-WAY ROADWAY
APPROACH LANE

DRAWING 405-01-E(1)
DRAWING 405-01-E(2) - FLAGGING OPERATIONS
MULTIPLE FLAGGERS
TWO-LANE TWO-WAY ROADWAYS
PRIMARY & SECONDARY ROUTES
WORK ACTIVITY AREA
INTERSECTIONS with
LOW SPEED
< / = 35 MPH
MULTILANE ROADWAYS

DRAWING 405-01-F(1)
DRAWING 405-01-F(2) - FLAGGING OPERATIONS
MULTIPLE FLAGGERS
TWO-LANE TWO-WAY ROADWAYS
PRIMARY & SECONDARY ROUTES
WORK ACTIVITY AREA
INTERSECTIONS with
INTERMEDIATE SPEED to HIGH SPEED
40 MPH - 60 MPH
MULTILANE ROADWAYS

DRAWING 405-02 - FLAGGING OPERATIONS
SINGLE FLAGGER OPERATION
LOW VOLUME
LOW SPEED TO INTERMEDIATE SPEED
TWO-LANE TWO-WAY ROADWAYS
PRIMARY & SECONDARY ROUTES

SHOULDER CLOSURES

DRAWING 515-01-A - RIGHT SHOULDER CLOSURE
CASE I / CASE II
TWO-LANE TWO-WAY ROADWAYS
PRIMARY & SECONDARY ROUTES

- DRAWING 515-01-C** - RIGHT SHOULDER CLOSURE
LOW SPEED
< / = 35 MPH
PRIMARY & SECONDARY ROUTES
(MINOR ENCROACHMENT)

MOBILIZED SHOULDER OPERATIONS

- DRAWING 525-01** - MOBILIZED SHOULDER OPERATIONS
ROAD MACHINERY – MINOR ENCROACHMENT
PRIMARY & SECONDARY ROUTES
- DRAWING 525-02** - MOBILIZED SHOULDER OPERATIONS
PEDESTRIAN WORKERS – NO ENCROACHMENT
ROAD MACHINERY – MINOR ENCROACHMENT
PRIMARY & SECONDARY ROUTES
- DRAWING 525-03** - MOBILIZED SHOULDER OPERATIONS
ROAD MACHINERY – MAJOR ENCROACHMENT
PRIMARY & SECONDARY ROUTES

MULTILANE SECONDARY AND PRIMARY ROADWAYS

Mobilized shoulder operations may be used for work activities that progress along the roadway at a slow pace and require road machinery operating on the shoulder to encroach upon the roadway.

On low speed roadways with speeds of 35 mph or less, shoulder closures designed for minor encroachment are acceptable for work activities conducted within 30 feet of the near edge of an adjacent travel lane that may require encroachment upon the roadway by personnel, tools, equipment, materials, vehicles, etc. to the extent that may require a reduction of the lane width of an adjacent travel lane to no less than 10 feet.

On low speed roadways with speeds of 35 mph or less, standard shoulder closures are required for work activities that require the presence of personnel, tools, equipment, materials, vehicles, etc. beyond 1 foot but within 30 feet of the near edge of an adjacent travel lane.

On low speed roadways, lane closures are required when encroachment of the work activities onto the roadway will reduce the lane width of the adjacent travel lane to less than 10 feet.

On intermediate to high speed roadways, standard shoulder closures are required for work activities that require the presence of personnel, tools, equipment, materials, vehicles, etc. beyond 1 foot but within 30 feet of the near edge of an adjacent travel lane.

On intermediate to high speed roadways, lane closures are required when the work activities require the presence of personnel, tools, equipment, materials, vehicles, etc. to encroach upon the roadway or to within 1 foot of the near edge of an adjacent travel lane.

Lane closures are required for work activities that cannot be conducted under the conditions required for standard shoulder closures, standard shoulder closures with minor encroachment or mobilized shoulder operations.

TYPICAL DRAWING APPLICATIONS

LANE CLOSURES

- DRAWING 505-01** - LANE CLOSURE
LOW SPEED MULTILANE
< / = 35 MPH
PRIMARY & SECONDARY ROUTES
- DRAWING 505-02** - DUAL LANE CLOSURE
LOW SPEED MULTILANE
< / = 35 MPH
PRIMARY & SECONDARY ROUTES

- DRAWING 505-03-A** - LANE CLOSURE
INTERMEDIATE SPEED TO HIGH SPEED
40 MPH - 60 MPH
MULTILANE
PRIMARY & SECONDARY ROUTES
- DRAWING 505-04-A** - DUAL LANE CLOSURE
TRANSITION / ACTIVITY AREAS
INTERMEDIATE SPEED TO HIGH SPEED
40 MPH - 60 MPH
MULTILANE
PRIMARY & SECONDARY ROUTES
- DRAWING 505-04-B** - DUAL LANE CLOSURE
ADVANCE WARNING AREA
INTERMEDIATE SPEED TO HIGH SPEED
40 MPH - 60 MPH
MULTILANE
PRIMARY & SECONDARY ROUTES

SHOULDER CLOSURES

- DRAWING 515-01-B** - RIGHT SHOULDER CLOSURE
CASE I / CASE II
MULTILANE
PRIMARY & SECONDARY ROUTES
- DRAWING 515-01-C** - RIGHT SHOULDER CLOSURE
LOW SPEED
< / = 35 MPH
PRIMARY & SECONDARY ROUTES
(MINOR ENCROACHMENT)
- DRAWING 515-01-D** - LEFT SHOULDER CLOSURE
LOW SPEED
< / = 35 MPH
MULTILANE DIVIDED HIGHWAY
w/ GRASSED EARTH MEDIAN
PRIMARY & SECONDARY ROUTES
(MINOR ENCROACHMENT)
- DRAWING 515-02** - LEFT SHOULDER CLOSURE
CASE I / CASE I
MULTILANE
PRIMARY & SECONDARY ROUTES
- DRAWING 515-03** - LEFT SHOULDER CLOSURE
CASE I / CASE II
MULTILANE
PRIMARY & SECONDARY ROUTES

MOBILIZED SHOULDER OPERATIONS

- DRAWING 525-01** - MOBILIZED SHOULDER OPERATIONS
ROAD MACHINERY – MINOR ENCROACHMENT
PRIMARY & SECONDARY ROUTES
- DRAWING 525-02** - MOBILIZED SHOULDER OPERATIONS
PEDESTRIAN WORKERS – NO ENCROACHMENT
ROAD MACHINERY – MINOR ENCROACHMENT
PRIMARY & SECONDARY ROUTES
- DRAWING 525-03** - MOBILIZED SHOULDER OPERATIONS
ROAD MACHINERY – MAJOR ENCROACHMENT
PRIMARY & SECONDARY ROUTES

INTERSTATE ROADWAYS

Mobilized shoulder operations may be used for work activities that progress along the roadway at a slow pace and require equipment, personnel, materials, or any vehicles to encroach upon the adjacent paved shoulder within the limits specified by the typical drawing applications for interstate mobilized shoulder operations.

Standard shoulder closures are required for stationary work activities that require the presence of personnel, tools, equipment, materials, vehicles, etc. beyond 10 feet but within 30 feet of the near edge of an adjacent travel lane.

Lane closures are required for work activities that cannot be conducted under the conditions required for mobilized shoulder operations or standard shoulder closures.

(Brief periodic encroachments upon the adjacent travel lane for the equipment to relocate or bypass structures such as guardrail locations or bridge structures are acceptable.)

TYPICAL DRAWING APPLICATIONS

LANE CLOSURES

- DRAWING 510-01-A - LANE CLOSURE
INTERSTATE ROUTES
- DRAWING 510-01-B - LANE CLOSURE
EXIT / ENTRANCE RAMPS
INTERSTATE ROUTES

SHOULDER CLOSURES

- DRAWING 520-01 - RIGHT SHOULDER CLOSURE
CASE I / CASE II
INTERSTATE ROUTES
- DRAWING 520-02 - LEFT SHOULDER CLOSURE
CASE I / CASE I
NARROW MEDIAN
INTERSTATE ROUTES
- DRAWING 520-03 - LEFT SHOULDER CLOSURE
CASE I / CASE I
WIDE MEDIAN
INTERSTATE ROUTES
- DRAWING 520-04 - LEFT SHOULDER CLOSURE
CASE I / CASE II
WIDE MEDIAN
INTERSTATE ROUTES
- DRAWING 520-05 - LEFT SHOULDER CLOSURE
CASE II / CASE II
WIDE MEDIAN
INTERSTATE ROUTES

MOBILIZED SHOULDER OPERATIONS

- DRAWING 530-01** - MOBILIZED SHOULDER OPERATIONS
ROAD MACHINERY – MAJOR ENCROACHMENT
INTERSTATE ROUTES

- DRAWING 530-02** - MOBILIZED SHOULDER OPERATIONS
PEDESTRIAN WORKERS – MINOR ENCROACHMENT
UPON PAVED SHOULDER
INTERSTATE ROUTES

- DRAWING 530-03** - MOBILIZED SHOULDER OPERATIONS
PEDESTRIAN WORKERS – MAJOR ENCROACHMENT
UPON PAVED SHOULDER
ROAD MACHINERY – MAJOR ENCROACHMENT
UPON TRAVEL LANE
INTERSTATE ROUTES

PERFORMANCE ACTIVITY 203

SHOULDERS / DITCHES

WORK DESCRIPTION 1	Clean Outfall
WORK DESCRIPTION 2	Construct Outfall
WORK DESCRIPTION 3	Regrade Roadside Ditch
WORK DESCRIPTION 4	Regrade / Repair Shoulder
WORK DESCRIPTION 5	Regrade Shoulder and Ditch
WORK DESCRIPTION 6	Widen Shoulder

203 SHOULDERS / DITCHES

ACTIVITY DESCRIPTION

Maintain earth shoulders, roadside ditches, and outfall ditches to ensure proper drainage of the roadway surface.

WORK DESCRIPTION 1 Clean Outfall

WORK DESCRIPTION 2 Construct Outfall

TRAFFIC CONTROL

TWO-LANE TWO-WAY ROADWAYS

On low speed roadways with speeds of 35 mph or less, shoulder closures designed for minor encroachment are acceptable for work activities conducted within 30 feet of the near edge of an adjacent travel lane that may require encroachment upon the roadway by personnel, tools, equipment, materials, vehicles, etc. to the extent that may require a reduction of the lane width of an adjacent travel lane to no less than 10 feet.

On low speed roadways with speeds of 35 mph or less, standard shoulder closures are required for work activities that require the presence of personnel, tools, equipment, materials, vehicles, etc. beyond 1 foot but within 30 feet of the near edge of an adjacent travel lane.

On intermediate to high speed roadways, flagging operations are required when the work activities require the presence of personnel, tools, equipment, materials, vehicles, etc. to encroach upon the roadway or to within 1 foot of the near edge of an adjacent travel lane.

On intermediate to high speed roadways, standard shoulder closures are required for work activities that require the presence of personnel, tools, equipment, materials, vehicles, etc. beyond 1 foot but within 30 feet of the near edge of an adjacent travel lane.

Flagging operations are required for work activities that cannot be conducted under the conditions required for standard shoulder closures or shoulder closures with minor encroachment.

TYPICAL DRAWING APPLICATIONS

FLAGGING OPERATIONS

DRAWING 405-01-A	-	FLAGGING OPERATIONS MULTIPLE FLAGGERS TWO-LANE TWO-WAY ROADWAYS PRIMARY & SECONDARY ROUTES
DRAWING 405-01-B(1)	-	FLAGGING OPERATIONS MULTIPLE FLAGGERS TWO-LANE TWO-WAY ROADWAYS PRIMARY & SECONDARY ROUTES STOP SIGN CONTROLLED SIDE ROADS
DRAWING 405-01-B(2)	-	FLAGGING OPERATIONS MULTIPLE FLAGGERS TWO-LANE TWO-WAY ROADWAYS PRIMARY & SECONDARY ROUTES 4-WAY STOP CONTROLLED INTERSECTION
DRAWING 405-01-C(1)	-	FLAGGING OPERATIONS MULTIPLE FLAGGERS TWO-LANE TWO-WAY ROADWAYS PRIMARY & SECONDARY ROUTES TRAFFIC SIGNAL CONTROLLED INTERSECTION LAW ENFORCEMENT OFFICER(S)

DRAWING 405-01-C(2) - FLAGGING OPERATIONS
MULTIPLE FLAGGERS
TWO-LANE TWO-WAY ROADWAYS
PRIMARY & SECONDARY ROUTES
TRAFFIC SIGNAL CONTROLLED INTERSECTION
FLAGGERS

DRAWING 405-01-D(1) - FLAGGING OPERATIONS
MULTIPLE FLAGGERS
TWO-LANE TWO-WAY ROADWAYS
PRIMARY & SECONDARY ROUTES
WORK ACTIVITY AREA
BEGINNING at an
INTERSECTION with a
TWO-LANE TWO-WAY ROADWAY
DEPARTURE LANE

DRAWING 405-01-D(2) - FLAGGING OPERATIONS
MULTIPLE FLAGGERS
TWO-LANE TWO-WAY ROADWAYS
PRIMARY & SECONDARY ROUTES
WORK ACTIVITY AREA
TERMINATING at an
INTERSECTION with a
TWO-LANE TWO-WAY ROADWAY
APPROACH LANE

DRAWING 405-01-E(1)
DRAWING 405-01-E(2) - FLAGGING OPERATIONS
MULTIPLE FLAGGERS
TWO-LANE TWO-WAY ROADWAYS
PRIMARY & SECONDARY ROUTES
WORK ACTIVITY AREA
INTERSECTIONS with
LOW SPEED
< / = 35 MPH
MULTILANE ROADWAYS

DRAWING 405-01-F(1)
DRAWING 405-01-F(2) - FLAGGING OPERATIONS
MULTIPLE FLAGGERS
TWO-LANE TWO-WAY ROADWAYS
PRIMARY & SECONDARY ROUTES
WORK ACTIVITY AREA
INTERSECTIONS with
INTERMEDIATE SPEED to HIGH SPEED
40 MPH - 60 MPH
MULTILANE ROADWAYS

DRAWING 405-02 - FLAGGING OPERATIONS
SINGLE FLAGGER OPERATION
LOW VOLUME
LOW SPEED TO INTERMEDIATE SPEED
TWO-LANE TWO-WAY ROADWAYS
PRIMARY & SECONDARY ROUTES

SHOULDER CLOSURES

DRAWING 515-01-A - RIGHT SHOULDER CLOSURE
CASE I / CASE II
TWO-LANE TWO-WAY ROADWAYS
PRIMARY & SECONDARY ROUTES

DRAWING 515-01-C - RIGHT SHOULDER CLOSURE
 LOW SPEED
 < / = 35 MPH
 PRIMARY & SECONDARY ROUTES
 (MINOR ENCROACHMENT)

MULTILANE SECONDARY AND PRIMARY ROADWAYS

On low speed roadways with speeds of 35 mph or less, shoulder closures designed for minor encroachment are acceptable for work activities conducted within 30 feet of the near edge of an adjacent travel lane that may require encroachment upon the roadway by personnel, tools, equipment, materials, vehicles, etc. to the extent that may require a reduction of the lane width of an adjacent travel lane to no less than 10 feet.

On low speed roadways with speeds of 35 mph or less, standard shoulder closures are required for work activities that require the presence of personnel, tools, equipment, materials, vehicles, etc. beyond 1 foot but within 30 feet of the near edge of an adjacent travel lane.

On intermediate to high speed roadways, standard shoulder closures are required for work activities that require the presence of personnel, tools, equipment, materials, vehicles, etc. beyond 1 foot but within 30 feet of the near edge of an adjacent travel lane.

On intermediate to high speed roadways, lane closures are required when the work activities require the presence of personnel, tools, equipment, materials, vehicles, etc. to encroach upon the roadway or to within 1 foot of the near edge of an adjacent travel lane.

Lane closures are required for work activities that cannot be conducted under the conditions required for standard shoulder closures or standard shoulder closures with minor encroachment.

TYPICAL DRAWING APPLICATIONS

LANE CLOSURES

DRAWING 505-01 - LANE CLOSURE
 LOW SPEED MULTILANE
 < / = 35 MPH
 PRIMARY & SECONDARY ROUTES

DRAWING 505-02 - DUAL LANE CLOSURE
 LOW SPEED MULTILANE
 < / = 35 MPH
 PRIMARY & SECONDARY ROUTES

DRAWING 505-03-A - LANE CLOSURE
 INTERMEDIATE SPEED TO HIGH SPEED
 40 MPH - 60 MPH
 MULTILANE
 PRIMARY & SECONDARY ROUTES

DRAWING 505-04-A - DUAL LANE CLOSURE
 TRANSITION / ACTIVITY AREAS
 INTERMEDIATE SPEED TO HIGH SPEED
 40 MPH - 60 MPH
 MULTILANE
 PRIMARY & SECONDARY ROUTES

DRAWING 505-04-B - DUAL LANE CLOSURE
 ADVANCE WARNING AREA
 INTERMEDIATE SPEED TO HIGH SPEED
 40 MPH - 60 MPH
 MULTILANE
 PRIMARY & SECONDARY ROUTES

SHOULDER CLOSURES

- DRAWING 515-01-B** - RIGHT SHOULDER CLOSURE
CASE I / CASE II
MULTILANE
PRIMARY & SECONDARY ROUTES
- DRAWING 515-01-C** - RIGHT SHOULDER CLOSURE
LOW SPEED
< / = 35 MPH
PRIMARY & SECONDARY ROUTES
(MINOR ENCROACHMENT)
- DRAWING 515-01-D** - LEFT SHOULDER CLOSURE
LOW SPEED
< / = 35 MPH
MULTILANE DIVIDED HIGHWAY
w/ GRASSED EARTH MEDIAN
PRIMARY & SECONDARY ROUTES
(MINOR ENCROACHMENT)
- DRAWING 515-02** - LEFT SHOULDER CLOSURE
CASE I / CASE I
MULTILANE
PRIMARY & SECONDARY ROUTES
- DRAWING 515-03** - LEFT SHOULDER CLOSURE
CASE I / CASE II
MULTILANE
PRIMARY & SECONDARY ROUTES

INTERSTATE ROADWAYS

Lane closures are required for work activities that require equipment, personnel, materials, or any vehicles to encroach upon a travel lane or within 10 feet of a travel lane. When the work may be performed without the necessity for equipment, personnel, materials, or vehicles to encroach within 10 feet of the adjacent travel, utilize shoulder closures.

TYPICAL DRAWING APPLICATIONS

LANE CLOSURES

- DRAWING 510-01-A** - LANE CLOSURE
INTERSTATE ROUTES
- DRAWING 510-01-B** - LANE CLOSURE
EXIT / ENTRANCE RAMPS
INTERSTATE ROUTES

SHOULDER CLOSURES

- DRAWING 520-01** - RIGHT SHOULDER CLOSURE
CASE I / CASE II
INTERSTATE ROUTES
- DRAWING 520-02** - LEFT SHOULDER CLOSURE
CASE I / CASE I
NARROW MEDIAN
INTERSTATE ROUTES
- DRAWING 520-03** - LEFT SHOULDER CLOSURE
CASE I / CASE I
WIDE MEDIAN
INTERSTATE ROUTES

- DRAWING 520-04** - LEFT SHOULDER CLOSURE
CASE I / CASE II
WIDE MEDIAN
INTERSTATE ROUTES
- DRAWING 520-05** - LEFT SHOULDER CLOSURE
CASE II / CASE II
WIDE MEDIAN
INTERSTATE ROUTES

- WORK DESCRIPTION 3** Regrade Roadside Ditch
- WORK DESCRIPTION 4** Regrade / Repair Shoulder
- WORK DESCRIPTION 5** Regrade Shoulder and Ditch
- WORK DESCRIPTION 6** Widen Shoulder

TRAFFIC CONTROL

TWO-LANE TWO-WAY ROADWAYS

Mobilized shoulder operations may be used for work activities requiring only one (1) single equipment unit that progress along the roadway at a slow pace and require road machinery operating on the shoulder to encroach upon the roadway.

On low speed roadways with speeds of 35 mph or less, shoulder closures designed for minor encroachment are acceptable for work activities conducted within 30 feet of the near edge of an adjacent travel lane that may require encroachment upon the roadway by personnel, tools, equipment, materials, vehicles, etc. to the extent that may require a reduction of the lane width of an adjacent travel lane to no less than 10 feet.

On low speed roadways with speeds of 35 mph or less, standard shoulder closures are required for work activities that require the presence of personnel, tools, equipment, materials, vehicles, etc. beyond 1 foot but within 30 feet of the near edge of an adjacent travel lane.

On intermediate to high speed roadways, standard shoulder closures are required for work activities that require the presence of personnel, tools, equipment, materials, vehicles, etc. beyond 1 foot but within 30 feet of the near edge of an adjacent travel lane.

On intermediate to high speed roadways, flagging operations are required when the work activities require the presence of personnel, tools, equipment, materials, vehicles, etc. to encroach upon the roadway or to within 1 foot of the near edge of an adjacent travel lane.

Flagging operations are required for work activities that cannot be conducted under the conditions required for standard shoulder closures, shoulder closures with minor encroachment or mobilized shoulder operations.

TYPICAL DRAWING APPLICATIONS

FLAGGING OPERATIONS

- DRAWING 405-01-A** - FLAGGING OPERATIONS
MULTIPLE FLAGGERS
TWO-LANE TWO-WAY ROADWAYS
PRIMARY & SECONDARY ROUTES
- DRAWING 405-01-B(1)** - FLAGGING OPERATIONS
MULTIPLE FLAGGERS
TWO-LANE TWO-WAY ROADWAYS
PRIMARY & SECONDARY ROUTES
STOP SIGN CONTROLLED SIDE ROADS
- DRAWING 405-01-B(2)** - FLAGGING OPERATIONS
MULTIPLE FLAGGERS
TWO-LANE TWO-WAY ROADWAYS
PRIMARY & SECONDARY ROUTES
4-WAY STOP CONTROLLED INTERSECTION

- DRAWING 405-01-C(1)** - FLAGGING OPERATIONS
MULTIPLE FLAGGERS
TWO-LANE TWO-WAY ROADWAYS
PRIMARY & SECONDARY ROUTES
TRAFFIC SIGNAL CONTROLLED INTERSECTION
LAW ENFORCEMENT OFFICER(S)
- DRAWING 405-01-C(2)** - FLAGGING OPERATIONS
MULTIPLE FLAGGERS
TWO-LANE TWO-WAY ROADWAYS
PRIMARY & SECONDARY ROUTES
TRAFFIC SIGNAL CONTROLLED INTERSECTION
FLAGGERS
- DRAWING 405-01-D(1)** - FLAGGING OPERATIONS
MULTIPLE FLAGGERS
TWO-LANE TWO-WAY ROADWAYS
PRIMARY & SECONDARY ROUTES
WORK ACTIVITY AREA
BEGINNING at an
INTERSECTION with a
TWO-LANE TWO-WAY ROADWAY
DEPARTURE LANE
- DRAWING 405-01-D(2)** - FLAGGING OPERATIONS
MULTIPLE FLAGGERS
TWO-LANE TWO-WAY ROADWAYS
PRIMARY & SECONDARY ROUTES
WORK ACTIVITY AREA
TERMINATING at an
INTERSECTION with a
TWO-LANE TWO-WAY ROADWAY
APPROACH LANE
- DRAWING 405-01-E(1)**
DRAWING 405-01-E(2) - FLAGGING OPERATIONS
MULTIPLE FLAGGERS
TWO-LANE TWO-WAY ROADWAYS
PRIMARY & SECONDARY ROUTES
WORK ACTIVITY AREA
INTERSECTIONS with
LOW SPEED
< / = 35 MPH
MULTILANE ROADWAYS
- DRAWING 405-01-F(1)**
DRAWING 405-01-F(2) - FLAGGING OPERATIONS
MULTIPLE FLAGGERS
TWO-LANE TWO-WAY ROADWAYS
PRIMARY & SECONDARY ROUTES
WORK ACTIVITY AREA
INTERSECTIONS with
INTERMEDIATE SPEED to HIGH SPEED
40 MPH - 60 MPH
MULTILANE ROADWAYS
- DRAWING 405-02** - FLAGGING OPERATIONS
SINGLE FLAGGER OPERATION
LOW VOLUME
LOW SPEED TO INTERMEDIATE SPEED
TWO-LANE TWO-WAY ROADWAYS
PRIMARY & SECONDARY ROUTES

SHOULDER CLOSURES

- DRAWING 515-01-A** - RIGHT SHOULDER CLOSURE
CASE I / CASE II
TWO-LANE TWO-WAY ROADWAYS
PRIMARY & SECONDARY ROUTES
- DRAWING 515-01-C** - RIGHT SHOULDER CLOSURE
LOW SPEED
< / = 35 MPH
PRIMARY & SECONDARY ROUTES
(MINOR ENCROACHMENT)

MOBILIZED SHOULDER OPERATIONS

- DRAWING 525-01** - MOBILIZED SHOULDER OPERATIONS
ROAD MACHINERY – MINOR ENCROACHMENT
PRIMARY & SECONDARY ROUTES
- DRAWING 525-02** - MOBILIZED SHOULDER OPERATIONS
PEDESTRIAN WORKERS – NO ENCROACHMENT
ROAD MACHINERY – MINOR ENCROACHMENT
PRIMARY & SECONDARY ROUTES
- DRAWING 525-03** - MOBILIZED SHOULDER OPERATIONS
ROAD MACHINERY – MAJOR ENCROACHMENT
PRIMARY & SECONDARY ROUTES

MULTILANE SECONDARY AND PRIMARY ROADWAYS

Mobilized shoulder operations may be used for work activities requiring only one (1) single equipment unit that progress along the roadway at a slow pace and require road machinery operating on the shoulder to encroach upon the roadway.

On low speed roadways with speeds of 35 mph or less, shoulder closures designed for minor encroachment are acceptable for work activities conducted within 30 feet of the near edge of an adjacent travel lane that may require encroachment upon the roadway by personnel, tools, equipment, materials, vehicles, etc. to the extent that may require a reduction of the lane width of an adjacent travel lane to no less than 10 feet.

On low speed roadways with speeds of 35 mph or less, standard shoulder closures are required for work activities that require the presence of personnel, tools, equipment, materials, vehicles, etc. beyond 1 foot but within 30 feet of the near edge of an adjacent travel lane.

On intermediate to high speed roadways, standard shoulder closures are required for work activities that require the presence of personnel, tools, equipment, materials, vehicles, etc. beyond 1 foot but within 30 feet of the near edge of an adjacent travel lane.

On intermediate to high speed roadways, lane closures are required when the work activities require the presence of personnel, tools, equipment, materials, vehicles, etc. to encroach upon the roadway or to within 1 foot of the near edge of an adjacent travel lane.

Lane closures are required for work activities that cannot be conducted under the conditions required for standard shoulder closures, standard shoulder closures with minor encroachment or mobilized shoulder operations.

TYPICAL DRAWING APPLICATIONS

LANE CLOSURES

- DRAWING 505-01** - LANE CLOSURE
LOW SPEED MULTILANE
< / = 35 MPH
PRIMARY & SECONDARY ROUTES

- DRAWING 505-02** - DUAL LANE CLOSURE
LOW SPEED MULTILANE
< / = 35 MPH
PRIMARY & SECONDARY ROUTES
- DRAWING 505-03-A** - LANE CLOSURE
INTERMEDIATE SPEED TO HIGH SPEED
40 MPH - 60 MPH
MULTILANE
PRIMARY & SECONDARY ROUTES
- DRAWING 505-04-A** - DUAL LANE CLOSURE
TRANSITION / ACTIVITY AREAS
INTERMEDIATE SPEED TO HIGH SPEED
40 MPH - 60 MPH
MULTILANE
PRIMARY & SECONDARY ROUTES
- DRAWING 505-04-B** - DUAL LANE CLOSURE
ADVANCE WARNING AREA
INTERMEDIATE SPEED TO HIGH SPEED
40 MPH - 60 MPH
MULTILANE
PRIMARY & SECONDARY ROUTES

SHOULDER CLOSURES

- DRAWING 515-01-B** - RIGHT SHOULDER CLOSURE
CASE I / CASE II
MULTILANE
PRIMARY & SECONDARY ROUTES
- DRAWING 515-01-C** - RIGHT SHOULDER CLOSURE
LOW SPEED
< / = 35 MPH
PRIMARY & SECONDARY ROUTES
(MINOR ENCROACHMENT)
- DRAWING 515-01-D** - LEFT SHOULDER CLOSURE
LOW SPEED
< / = 35 MPH
MULTILANE DIVIDED HIGHWAY
w/ GRASSED EARTH MEDIAN
PRIMARY & SECONDARY ROUTES
(MINOR ENCROACHMENT)
- DRAWING 515-02** - LEFT SHOULDER CLOSURE
CASE I / CASE I
MULTILANE
PRIMARY & SECONDARY ROUTES
- DRAWING 515-03** - LEFT SHOULDER CLOSURE
CASE I / CASE II
MULTILANE
PRIMARY & SECONDARY ROUTES

MOBILIZED SHOULDER OPERATIONS

- | | | |
|-----------------------|---|--|
| DRAWING 525-01 | - | MOBILIZED SHOULDER OPERATIONS
ROAD MACHINERY – MINOR ENCROACHMENT
PRIMARY & SECONDARY ROUTES |
| DRAWING 525-02 | - | MOBILIZED SHOULDER OPERATIONS
PEDESTRIAN WORKERS – NO ENCROACHMENT
ROAD MACHINERY – MINOR ENCROACHMENT
PRIMARY & SECONDARY ROUTES |
| DRAWING 525-03 | - | MOBILIZED SHOULDER OPERATIONS
ROAD MACHINERY – MAJOR ENCROACHMENT
PRIMARY & SECONDARY ROUTES |

INTERSTATE ROADWAYS

Mobilized shoulder operations may be used for work activities that progress along the roadway at a slow pace and require equipment, personnel, materials, or any vehicles to encroach upon the adjacent paved shoulder within the limits specified by the typical drawing applications for interstate mobilized shoulder operations.

Standard shoulder closures are required for stationary work activities that require the presence of personnel, tools, equipment, materials, vehicles, etc. beyond 10 feet but within 30 feet of the near edge of an adjacent travel lane.

Lane closures are required for work activities that cannot be conducted under the conditions required for mobilized shoulder operations or standard shoulder closures.

(Brief periodic encroachments upon the adjacent travel lane for the equipment to relocate or bypass structures such as guardrail locations or bridge structures are acceptable.)

TYPICAL DRAWING APPLICATIONS

LANE CLOSURES

- | | | |
|-------------------------|---|--|
| DRAWING 510-01-A | - | LANE CLOSURE
INTERSTATE ROUTES |
| DRAWING 510-01-B | - | LANE CLOSURE
EXIT / ENTRANCE RAMPS
INTERSTATE ROUTES |

SHOULDER CLOSURES

- | | | |
|-----------------------|---|--|
| DRAWING 520-01 | - | RIGHT SHOULDER CLOSURE
CASE I / CASE II
INTERSTATE ROUTES |
| DRAWING 520-02 | - | LEFT SHOULDER CLOSURE
CASE I / CASE I
NARROW MEDIAN
INTERSTATE ROUTES |
| DRAWING 520-03 | - | LEFT SHOULDER CLOSURE
CASE I / CASE I
WIDE MEDIAN
INTERSTATE ROUTES |
| DRAWING 520-04 | - | LEFT SHOULDER CLOSURE
CASE I / CASE II
WIDE MEDIAN
INTERSTATE ROUTES |

DRAWING 520-05 - LEFT SHOULDER CLOSURE
CASE II / CASE II
WIDE MEDIAN
INTERSTATE ROUTES

MOBILIZED SHOULDER OPERATIONS

DRAWING 530-01 - MOBILIZED SHOULDER OPERATIONS
ROAD MACHINERY – MAJOR ENCROACHMENT
INTERSTATE ROUTES

DRAWING 530-02 - MOBILIZED SHOULDER OPERATIONS
PEDESTRIAN WORKERS – MINOR ENCROACHMENT
UPON PAVED SHOULDER
INTERSTATE ROUTES

PERFORMANCE ACTIVITY 204

CONSTRUCTION / PAVING

WORK DESCRIPTION 1
WORK DESCRIPTION 2
WORK DESCRIPTION 3

Pavement Widening / Turn Lanes
Shoulder Paving
Median Paving (Crossover)

ACTIVITY DESCRIPTION

Construct 2 to 4 foot roadway widening or shoulder paving to improve narrow travel lanes and / or to provide paved shoulders Also, widen roadways to accommodate turn lanes or crossovers.

WORK DESCRIPTION 1 Pavement Widening / Turn Lanes

WORK DESCRIPTION 2 Shoulder Paving

WORK DESCRIPTION 3 Median Paving (Crossover)

TRAFFIC CONTROL

TWO-LANE TWO-WAY ROADWAYS

On low speed roadways with speeds of 35 mph or less, shoulder closures designed for minor encroachment are acceptable for work activities conducted within 30 feet of the near edge of an adjacent travel lane that may require encroachment upon the roadway by personnel, tools, equipment, materials, vehicles, etc. to the extent that may require a reduction of the lane width of an adjacent travel lane to no less than 10 feet.

On low speed roadways with speeds of 35 mph or less, standard shoulder closures are required for work activities that require the presence of personnel, tools, equipment, materials, vehicles, etc. beyond 1 foot but within 30 feet of the near edge of an adjacent travel lane.

On intermediate to high speed roadways, standard shoulder closures are required for work activities that require the presence of personnel, tools, equipment, materials, vehicles, etc. beyond 1 foot but within 30 feet of the near edge of an adjacent travel lane.

On intermediate to high speed roadways, flagging operations are required when the work activities require the presence of personnel, tools, equipment, materials, vehicles, etc. to encroach upon the roadway or to within 1 foot of the near edge of an adjacent travel lane.

Flagging operations are required for work activities that cannot be conducted under the conditions required for standard shoulder closures or shoulder closures with minor encroachment.

TYPICAL DRAWING APPLICATIONS

FLAGGING OPERATIONS

- DRAWING 405-01-A** - FLAGGING OPERATIONS
MULTIPLE FLAGGERS
TWO-LANE TWO-WAY ROADWAYS
PRIMARY & SECONDARY ROUTES
- DRAWING 405-01-B(1)** - FLAGGING OPERATIONS
MULTIPLE FLAGGERS
TWO-LANE TWO-WAY ROADWAYS
PRIMARY & SECONDARY ROUTES
STOP SIGN CONTROLLED SIDE ROADS
- DRAWING 405-01-B(2)** - FLAGGING OPERATIONS
MULTIPLE FLAGGERS
TWO-LANE TWO-WAY ROADWAYS
PRIMARY & SECONDARY ROUTES
4-WAY STOP CONTROLLED INTERSECTION
- DRAWING 405-01-C(1)** - FLAGGING OPERATIONS
MULTIPLE FLAGGERS
TWO-LANE TWO-WAY ROADWAYS
PRIMARY & SECONDARY ROUTES
TRAFFIC SIGNAL CONTROLLED INTERSECTION
LAW ENFORCEMENT OFFICER(S)

- DRAWING 405-01-C(2)** - FLAGGING OPERATIONS
MULTIPLE FLAGGERS
TWO-LANE TWO-WAY ROADWAYS
PRIMARY & SECONDARY ROUTES
TRAFFIC SIGNAL CONTROLLED INTERSECTION
FLAGGERS
- DRAWING 405-01-D(1)** - FLAGGING OPERATIONS
MULTIPLE FLAGGERS
TWO-LANE TWO-WAY ROADWAYS
PRIMARY & SECONDARY ROUTES
WORK ACTIVITY AREA
BEGINNING at an
INTERSECTION with a
TWO-LANE TWO-WAY ROADWAY
DEPARTURE LANE
- DRAWING 405-01-D(2)** - FLAGGING OPERATIONS
MULTIPLE FLAGGERS
TWO-LANE TWO-WAY ROADWAYS
PRIMARY & SECONDARY ROUTES
WORK ACTIVITY AREA
TERMINATING at an
INTERSECTION with a
TWO-LANE TWO-WAY ROADWAY
APPROACH LANE
- DRAWING 405-01-E(1)**
DRAWING 405-01-E(2) - FLAGGING OPERATIONS
MULTIPLE FLAGGERS
TWO-LANE TWO-WAY ROADWAYS
PRIMARY & SECONDARY ROUTES
WORK ACTIVITY AREA
INTERSECTIONS with
LOW SPEED
< / = 35 MPH
MULTILANE ROADWAYS
- DRAWING 405-01-F(1)**
DRAWING 405-01-F(2) - FLAGGING OPERATIONS
MULTIPLE FLAGGERS
TWO-LANE TWO-WAY ROADWAYS
PRIMARY & SECONDARY ROUTES
WORK ACTIVITY AREA
INTERSECTIONS with
INTERMEDIATE SPEED to HIGH SPEED
40 MPH - 60 MPH
MULTILANE ROADWAYS
- DRAWING 405-02** - FLAGGING OPERATIONS
SINGLE FLAGGER OPERATION
LOW VOLUME
LOW SPEED TO INTERMEDIATE SPEED
TWO-LANE TWO-WAY ROADWAYS
PRIMARY & SECONDARY ROUTES

SHOULDER CLOSURES

- DRAWING 515-01-A** - RIGHT SHOULDER CLOSURE
CASE I / CASE II
TWO-LANE TWO-WAY ROADWAYS
PRIMARY & SECONDARY ROUTES

- DRAWING 515-01-C** - RIGHT SHOULDER CLOSURE
LOW SPEED
< / = 35 MPH
PRIMARY & SECONDARY ROUTES
(MINOR ENCROACHMENT)

MULTILANE SECONDARY AND PRIMARY ROADWAYS

On low speed roadways with speeds of 35 mph or less, shoulder closures designed for minor encroachment are acceptable for work activities conducted within 30 feet of the near edge of an adjacent travel lane that may require encroachment upon the roadway by personnel, tools, equipment, materials, vehicles, etc. to the extent that may require a reduction of the lane width of an adjacent travel lane to no less than 10 feet.

On low speed roadways with speeds of 35 mph or less, standard shoulder closures are required for work activities that require the presence of personnel, tools, equipment, materials, vehicles, etc. beyond 1 foot but within 30 feet of the near edge of an adjacent travel lane.

On intermediate to high speed roadways, standard shoulder closures are required for work activities that require the presence of personnel, tools, equipment, materials, vehicles, etc. beyond 1 foot but within 30 feet of the near edge of an adjacent travel lane.

On intermediate to high speed roadways, lane closures are required when the work activities require the presence of personnel, tools, equipment, materials, vehicles, etc. to encroach upon the roadway or to within 1 foot of the near edge of an adjacent travel lane.

Lane closures are required for work activities that cannot be conducted under the conditions required for standard shoulder closures, shoulder closures with minor encroachment or mobilized shoulder operations.

TYPICAL DRAWING APPLICATIONS

LANE CLOSURES

- DRAWING 505-01** - LANE CLOSURE
LOW SPEED MULTILANE
< / = 35 MPH
PRIMARY & SECONDARY ROUTES

- DRAWING 505-03-A** - LANE CLOSURE
INTERMEDIATE SPEED TO HIGH SPEED
40 MPH - 60 MPH
MULTILANE
PRIMARY & SECONDARY ROUTES

SHOULDER CLOSURES

- DRAWING 515-01-A** - RIGHT SHOULDER CLOSURE
CASE I / CASE II
TWO-LANE TWO-WAY ROADWAYS
PRIMARY & SECONDARY ROUTES

- DRAWING 515-01-C** - RIGHT SHOULDER CLOSURE
LOW SPEED
< / = 35 MPH
PRIMARY & SECONDARY ROUTES
(MINOR ENCROACHMENT)

- DRAWING 515-01-D** - LEFT SHOULDER CLOSURE
LOW SPEED
< / = 35 MPH
MULTILANE DIVIDED HIGHWAY
w/ GRASSED EARTH MEDIAN
PRIMARY & SECONDARY ROUTES
(MINOR ENCROACHMENT)
- DRAWING 515-02** - LEFT SHOULDER CLOSURE
CASE I / CASE I
MULTILANE
PRIMARY & SECONDARY ROUTES
- DRAWING 515-03** - LEFT SHOULDER CLOSURE
CASE I / CASE II
MULTILANE
PRIMARY & SECONDARY ROUTES

INTERSTATE ROADWAYS

Lane closures are required for work activities that require equipment, personnel, materials, or any vehicles to encroach upon a travel lane or within 10 feet of a travel lane. When the work may be performed without the necessity for equipment, personnel, materials, or vehicles to encroach within 10 feet of the adjacent travel, utilize shoulder closures.

Lane closures are required for work activities that cannot be conducted under the conditions required for standard shoulder closures.

TYPICAL DRAWING APPLICATIONS

LANE CLOSURES

- DRAWING 510-01-A** - LANE CLOSURE
INTERSTATE ROUTES
- DRAWING 510-01-B** - LANE CLOSURE
EXIT / ENTRANCE RAMPS
INTERSTATE ROUTES

SHOULDER CLOSURES

- DRAWING 520-01** - RIGHT SHOULDER CLOSURE
CASE I / CASE II
INTERSTATE ROUTES
- DRAWING 520-02** - LEFT SHOULDER CLOSURE
CASE I / CASE I
NARROW MEDIAN
INTERSTATE ROUTES
- DRAWING 520-03** - LEFT SHOULDER CLOSURE
CASE I / CASE I
WIDE MEDIAN
INTERSTATE ROUTES
- DRAWING 520-04** - LEFT SHOULDER CLOSURE
CASE I / CASE II
WIDE MEDIAN
INTERSTATE ROUTES
- DRAWING 520-05** - LEFT SHOULDER CLOSURE
CASE II / CASE II
WIDE MEDIAN
INTERSTATE ROUTES

PERFORMANCE ACTIVITY 305

DRAINAGE STRUCTURES

WORK DESCRIPTION 1	Repair
WORK DESCRIPTION 2	Install
WORK DESCRIPTION 3	Upgrade
WORK DESCRIPTION 4	Clean

305 DRAINAGE STRUCTURES

ACTIVITY DESCRIPTION

Repair, install, upgrade and clean manholes, catch basins, drop inlets and box culverts.

WORK DESCRIPTION 1 Repair
WORK DESCRIPTION 2 Install
WORK DESCRIPTION 3 Upgrade
WORK DESCRIPTION 4 Clean

TRAFFIC CONTROL

TWO-LANE TWO-WAY ROADWAYS

On low speed roadways with speeds of 35 mph or less, shoulder closures designed for minor encroachment are acceptable for work activities conducted within 30 feet of the near edge of an adjacent travel lane that may require encroachment upon the roadway by personnel, tools, equipment, materials, vehicles, etc. to the extent that may require a reduction of the lane width of an adjacent travel lane to no less than 10 feet.

On low speed roadways with speeds of 35 mph or less, standard shoulder closures are required for work activities that require the presence of personnel, tools, equipment, materials, vehicles, etc. beyond 1 foot but within 30 feet of the near edge of an adjacent travel lane.

On intermediate to high speed roadways, standard shoulder closures are required for work activities that require the presence of personnel, tools, equipment, materials, vehicles, etc. beyond 1 foot but within 30 feet of the near edge of an adjacent travel lane.

On intermediate to high speed roadways, flagging operations are required when the work activities require the presence of personnel, tools, equipment, materials, vehicles, etc. to encroach upon the roadway or to within 1 foot of the near edge of an adjacent travel lane.

For operations conducted by machine, implementation of intermittent mobile operations to conduct the work are acceptable under the following conditions:

Condition 1 - The maximum time duration of a stop is 15 minutes if the work vehicle and/or the shadow vehicle encroach upon a travel lane more than 2 feet.

Condition 2 - The maximum time duration of a stop is 30 minutes if the work vehicle and/or the shadow vehicle encroach upon a travel lane 2 feet or less.

During intermittent mobile operations, utilize a shadow vehicle when the stopping sight distance interval between the work vehicle or road machinery and an approaching motorist is unavailable based upon the posted regulatory speed limit of the work location.

Flagging operations are required for work activities that cannot be conducted under the conditions required for standard shoulder closures, shoulder closures with minor encroachment or intermittent mobile operations.

TYPICAL DRAWING APPLICATIONS

FLAGGING OPERATIONS

DRAWING 405-01-A	-	FLAGGING OPERATIONS MULTIPLE FLAGGERS TWO-LANE TWO-WAY ROADWAYS PRIMARY & SECONDARY ROUTES
DRAWING 405-01-B(1)	-	FLAGGING OPERATIONS MULTIPLE FLAGGERS TWO-LANE TWO-WAY ROADWAYS PRIMARY & SECONDARY ROUTES STOP SIGN CONTROLLED SIDE ROADS

- DRAWING 405-01-B(2)** - FLAGGING OPERATIONS
MULTIPLE FLAGGERS
TWO-LANE TWO-WAY ROADWAYS
PRIMARY & SECONDARY ROUTES
4-WAY STOP CONTROLLED INTERSECTION
- DRAWING 405-01-C(1)** - FLAGGING OPERATIONS
MULTIPLE FLAGGERS
TWO-LANE TWO-WAY ROADWAYS
PRIMARY & SECONDARY ROUTES
TRAFFIC SIGNAL CONTROLLED INTERSECTION
LAW ENFORCEMENT OFFICER(S)
- DRAWING 405-01-C(2)** - FLAGGING OPERATIONS
MULTIPLE FLAGGERS
TWO-LANE TWO-WAY ROADWAYS
PRIMARY & SECONDARY ROUTES
TRAFFIC SIGNAL CONTROLLED INTERSECTION
FLAGGERS
- DRAWING 405-01-D(1)** - FLAGGING OPERATIONS
MULTIPLE FLAGGERS
TWO-LANE TWO-WAY ROADWAYS
PRIMARY & SECONDARY ROUTES
WORK ACTIVITY AREA
BEGINNING at an
INTERSECTION with a
TWO-LANE TWO-WAY ROADWAY
DEPARTURE LANE
- DRAWING 405-01-D(2)** - FLAGGING OPERATIONS
MULTIPLE FLAGGERS
TWO-LANE TWO-WAY ROADWAYS
PRIMARY & SECONDARY ROUTES
WORK ACTIVITY AREA
TERMINATING at an
INTERSECTION with a
TWO-LANE TWO-WAY ROADWAY
APPROACH LANE
- DRAWING 405-01-E(1)**
DRAWING 405-01-E(2) - FLAGGING OPERATIONS
MULTIPLE FLAGGERS
TWO-LANE TWO-WAY ROADWAYS
PRIMARY & SECONDARY ROUTES
WORK ACTIVITY AREA
INTERSECTIONS with
LOW SPEED
< / = 35 MPH
MULTILANE ROADWAYS
- DRAWING 405-01-F(1)**
DRAWING 405-01-F(2) - FLAGGING OPERATIONS
MULTIPLE FLAGGERS
TWO-LANE TWO-WAY ROADWAYS
PRIMARY & SECONDARY ROUTES
WORK ACTIVITY AREA
INTERSECTIONS with
INTERMEDIATE SPEED to HIGH SPEED
40 MPH - 60 MPH
MULTILANE ROADWAYS

- DRAWING 405-02** - FLAGGING OPERATIONS
SINGLE FLAGGER OPERATION
LOW VOLUME
LOW SPEED TO INTERMEDIATE SPEED
TWO-LANE TWO-WAY ROADWAYS
PRIMARY & SECONDARY ROUTES

SHOULDER CLOSURES

- DRAWING 515-01-A** - RIGHT SHOULDER CLOSURE
CASE I / CASE II
TWO-LANE TWO-WAY ROADWAYS
PRIMARY & SECONDARY ROUTES
- DRAWING 515-01-C** - RIGHT SHOULDER CLOSURE
LOW SPEED
< / = 35 MPH
PRIMARY & SECONDARY ROUTES
(MINOR ENCROACHMENT)

MOBILE OPERATIONS – INTERMITTENT

- DRAWING 535-01-A** - MOBILE OPERATIONS – INTERMITTENT
STOPPING SIGHT DISTANCE
VEHICLE TRAIN REQUIREMENTS
VERTICAL CURVE (HILL)
- DRAWING 535-01-B** - MOBILE OPERATIONS – INTERMITTENT
STOPPING SIGHT DISTANCE
VEHICLE TRAIN REQUIREMENTS
HORIZONTAL CURVE (CURVE)
- DRAWING 535-02-A** - MOBILE OPERATIONS – INTERMITTENT
LOW VOLUME
LOW SPEED
PRIMARY & SECONDARY ROUTES
- DRAWING 535-02-B** - MOBILE OPERATIONS – INTERMITTENT
LOW VOLUME
INTERMEDIATE SPEED TO HIGH SPEED
PRIMARY & SECONDARY ROUTES
- DRAWING 535-03-A** - MOBILE OPERATIONS – INTERMITTENT
INTERMEDIATE VOLUME
LOW SPEED
PRIMARY & SECONDARY ROUTES
- DRAWING 535-03-B** - MOBILE OPERATIONS – INTERMITTENT
INTERMEDIATE VOLUME
INTERMEDIATE SPEED TO HIGH SPEED
PRIMARY & SECONDARY ROUTES
- DRAWING 535-04-A** - MOBILE OPERATIONS – INTERMITTENT
HIGH VOLUME
LOW SPEED
PRIMARY & SECONDARY ROUTES
- DRAWING 535-04-C** - MOBILE OPERATIONS – INTERMITTENT
HIGH VOLUME
INTERMEDIATE SPEED TO HIGH SPEED
PRIMARY & SECONDARY ROUTES

MULTILANE SECONDARY AND PRIMARY ROADWAYS

On low speed roadways with speeds of 35 mph or less, shoulder closures designed for minor encroachment are acceptable for work activities conducted within 30 feet of the near edge of an adjacent travel lane that may require encroachment upon the roadway by personnel, tools, equipment, materials, vehicles, etc. to the extent that may require a reduction of the lane width of an adjacent travel lane to no less than 10 feet.

On low speed roadways with speeds of 35 mph or less, standard shoulder closures are required for work activities that require the presence of personnel, tools, equipment, materials, vehicles, etc. beyond 1 foot but within 30 feet of the near edge of an adjacent travel lane.

On intermediate to high speed roadways, standard shoulder closures are required for work activities that require the presence of personnel, tools, equipment, materials, vehicles, etc. beyond 1 foot but within 30 feet of the near edge of an adjacent travel lane.

On intermediate to high speed roadways, lane closures are required when the work activities require the presence of personnel, tools, equipment, materials, vehicles, etc. to encroach upon the roadway or to within 1 foot of the near edge of an adjacent travel lane.

For operations conducted by machine, implementation of intermittent mobile operations to conduct the work are acceptable under the following conditions:

Condition 1 - The maximum time duration of a stop is 15 minutes if the work vehicle and/or the shadow vehicle encroach upon a travel lane more than 2 feet.

Condition 2 - The maximum time duration of a stop is 30 minutes if the work vehicle and/or the shadow vehicle encroach upon a travel lane 2 feet or less.

During intermittent mobile operations, utilize a shadow vehicle when the stopping sight distance interval between the work vehicle or road machinery and an approaching motorist is unavailable based upon the posted regulatory speed limit of the work location.

Lane closures are required for work activities that cannot be conducted under the conditions required for standard shoulder closures, shoulder closures with minor encroachment or intermittent mobile operations.

TYPICAL DRAWING APPLICATIONS

LANE CLOSURES

DRAWING 505-01	-	LANE CLOSURE LOW SPEED MULTILANE < / = 35 MPH PRIMARY & SECONDARY ROUTES
DRAWING 505-02	-	DUAL LANE CLOSURE LOW SPEED MULTILANE < / = 35 MPH PRIMARY & SECONDARY ROUTES
DRAWING 505-03-A	-	LANE CLOSURE INTERMEDIATE SPEED TO HIGH SPEED 40 MPH - 60 MPH MULTILANE PRIMARY & SECONDARY ROUTES
DRAWING 505-04-A	-	DUAL LANE CLOSURE TRANSITION / ACTIVITY AREAS INTERMEDIATE SPEED TO HIGH SPEED 40 MPH - 60 MPH MULTILANE PRIMARY & SECONDARY ROUTES

DRAWING 505-04-B - DUAL LANE CLOSURE
ADVANCE WARNING AREA
INTERMEDIATE SPEED TO HIGH SPEED
40 MPH - 60 MPH
MULTILANE
PRIMARY & SECONDARY ROUTES

SHOULDER CLOSURES

DRAWING 515-01-B - RIGHT SHOULDER CLOSURE
CASE I / CASE II
MULTILANE
PRIMARY & SECONDARY ROUTES

DRAWING 515-01-C - RIGHT SHOULDER CLOSURE
LOW SPEED
< / = 35 MPH
PRIMARY & SECONDARY ROUTES
(MINOR ENCROACHMENT)

DRAWING 515-01-D - LEFT SHOULDER CLOSURE
LOW SPEED
< / = 35 MPH
MULTILANE DIVIDED HIGHWAY
w/ GRASSED EARTH MEDIAN
PRIMARY & SECONDARY ROUTES
(MINOR ENCROACHMENT)

DRAWING 515-02 - LEFT SHOULDER CLOSURE
CASE I / CASE I
MULTILANE
PRIMARY & SECONDARY ROUTES

DRAWING 515-03 - LEFT SHOULDER CLOSURE
CASE I / CASE II
MULTILANE
PRIMARY & SECONDARY ROUTES

MOBILE OPERATIONS – INTERMITTENT

DRAWING 535-01-A - MOBILE OPERATIONS – INTERMITTENT
STOPPING SIGHT DISTANCE
VEHICLE TRAIN REQUIREMENTS
VERTICAL CURVE (HILL)

DRAWING 535-01-B - MOBILE OPERATIONS – INTERMITTENT
STOPPING SIGHT DISTANCE
VEHICLE TRAIN REQUIREMENTS
HORIZONTAL CURVE (CURVE)

DRAWING 535-03-A - MOBILE OPERATIONS – INTERMITTENT
INTERMEDIATE VOLUME
LOW SPEED
PRIMARY & SECONDARY ROUTES

DRAWING 535-03-B - MOBILE OPERATIONS – INTERMITTENT
INTERMEDIATE VOLUME
INTERMEDIATE SPEED TO HIGH SPEED
PRIMARY & SECONDARY ROUTES

DRAWING 535-04-A - MOBILE OPERATIONS – INTERMITTENT
HIGH VOLUME
LOW SPEED
PRIMARY & SECONDARY ROUTES

- DRAWING 535-04-B** - MOBILE OPERATIONS – INTERMITTENT
HIGH VOLUME
LOW SPEED
INTERIOR TRAVEL LANE OPERATIONS
PRIMARY & SECONDARY ROUTES
- DRAWING 535-04-C** - MOBILE OPERATIONS – INTERMITTENT
HIGH VOLUME
INTERMEDIATE SPEED TO HIGH SPEED
PRIMARY & SECONDARY ROUTES

INTERSTATE ROADWAYS

Lane closures are required for work activities that require equipment, personnel, materials, or any vehicles to encroach upon a travel lane or within 10 feet of a travel lane. When the work may be performed without the necessity for equipment, personnel, materials, or vehicles to encroach within 10 feet of the adjacent travel, utilize shoulder closures.

TYPICAL DRAWING APPLICATIONS

LANE CLOSURES

- DRAWING 510-01-A** - LANE CLOSURE
INTERSTATE ROUTES
- DRAWING 510-01-B** - LANE CLOSURE
EXIT / ENTRANCE RAMPS
INTERSTATE ROUTES

SHOULDER CLOSURES

- DRAWING 520-01** - RIGHT SHOULDER CLOSURE
CASE I / CASE II
INTERSTATE ROUTES
- DRAWING 520-02** - LEFT SHOULDER CLOSURE
CASE I / CASE I
NARROW MEDIAN
INTERSTATE ROUTES
- DRAWING 520-03** - LEFT SHOULDER CLOSURE
CASE I / CASE I
WIDE MEDIAN
INTERSTATE ROUTES
- DRAWING 520-04** - LEFT SHOULDER CLOSURE
CASE I / CASE II
WIDE MEDIAN
INTERSTATE ROUTES
- DRAWING 520-05** - LEFT SHOULDER CLOSURE
CASE II / CASE II
WIDE MEDIAN
INTERSTATE ROUTES

MOBILIZED SHOULDER OPERATIONS

- DRAWING 530-03** - MOBILIZED SHOULDER OPERATIONS
PEDESTRIAN WORKERS – MAJOR ENCROACHMENT
UPON PAVED SHOULDER
ROAD MACHINERY – MAJOR ENCROACHMENT
UPON TRAVEL LANE
INTERSTATE ROUTES

PERFORMANCE ACTIVITY 306

DRAINAGE PIPE

WORK DESCRIPTION 1	Repair
WORK DESCRIPTION 2	Install
WORK DESCRIPTION 3	Remove
WORK DESCRIPTION 4	Clean

306 DRAINAGE PIPE

ACTIVITY DESCRIPTION

Install, repair, clean, and remove drainage pipe to correct or improve roadway drainage.

WORK DESCRIPTION 1 Repair
WORK DESCRIPTION 2 Install
WORK DESCRIPTION 3 Remove
WORK DESCRIPTION 4 Clean

TRAFFIC CONTROL

TWO-LANE TWO-WAY ROADWAYS

On low speed roadways with speeds of 35 mph or less, shoulder closures designed for minor encroachment are acceptable for work activities conducted within 30 feet of the near edge of an adjacent travel lane that may require encroachment upon the roadway by personnel, tools, equipment, materials, vehicles, etc. to the extent that may require a reduction of the lane width of an adjacent travel lane to no less than 10 feet.

On low speed roadways with speeds of 35 mph or less, standard shoulder closures are required for work activities that require the presence of personnel, tools, equipment, materials, vehicles, etc. beyond 1 foot but within 30 feet of the near edge of an adjacent travel lane.

On intermediate to high speed roadways, standard shoulder closures are required for work activities that require the presence of personnel, tools, equipment, materials, vehicles, etc. beyond 1 foot but within 30 feet of the near edge of an adjacent travel lane.

On intermediate to high speed roadways, flagging operations are required when the work activities require the presence of personnel, tools, equipment, materials, vehicles, etc. to encroach upon the roadway or to within 1 foot of the near edge of an adjacent travel lane.

For operations conducted by machine, implementation of intermittent mobile operations to conduct the work are acceptable under the following conditions:

Condition 1 - The maximum time duration of a stop is 15 minutes if the work vehicle and/or the shadow vehicle encroach upon a travel lane more than 2 feet.

Condition 2 - The maximum time duration of a stop is 30 minutes if the work vehicle and/or the shadow vehicle encroach upon a travel lane 2 feet or less.

During intermittent mobile operations, utilize a shadow vehicle when the stopping sight distance interval between the work vehicle or road machinery and an approaching motorist is unavailable based upon the posted regulatory speed limit of the work location.

Flagging operations are required for work activities that cannot be conducted under the conditions required for standard shoulder closures, shoulder closures with minor encroachment or intermittent mobile operations.

TYPICAL DRAWING APPLICATIONS

FLAGGING OPERATIONS

DRAWING 405-01-A	-	FLAGGING OPERATIONS MULTIPLE FLAGGERS TWO-LANE TWO-WAY ROADWAYS PRIMARY & SECONDARY ROUTES
DRAWING 405-01-B(1)	-	FLAGGING OPERATIONS MULTIPLE FLAGGERS TWO-LANE TWO-WAY ROADWAYS PRIMARY & SECONDARY ROUTES STOP SIGN CONTROLLED SIDE ROADS

- DRAWING 405-01-B(2)** - FLAGGING OPERATIONS
 MULTIPLE FLAGGERS
 TWO-LANE TWO-WAY ROADWAYS
 PRIMARY & SECONDARY ROUTES
 4-WAY STOP CONTROLLED INTERSECTION
- DRAWING 405-01-C(1)** - FLAGGING OPERATIONS
 MULTIPLE FLAGGERS
 TWO-LANE TWO-WAY ROADWAYS
 PRIMARY & SECONDARY ROUTES
 TRAFFIC SIGNAL CONTROLLED INTERSECTION
 LAW ENFORCEMENT OFFICER(S)
- DRAWING 405-01-C(2)** - FLAGGING OPERATIONS
 MULTIPLE FLAGGERS
 TWO-LANE TWO-WAY ROADWAYS
 PRIMARY & SECONDARY ROUTES
 TRAFFIC SIGNAL CONTROLLED INTERSECTION
 FLAGGERS
- DRAWING 405-01-D(1)** - FLAGGING OPERATIONS
 MULTIPLE FLAGGERS
 TWO-LANE TWO-WAY ROADWAYS
 PRIMARY & SECONDARY ROUTES
 WORK ACTIVITY AREA
 BEGINNING at an
 INTERSECTION with a
 TWO-LANE TWO-WAY ROADWAY
 DEPARTURE LANE
- DRAWING 405-01-D(2)** - FLAGGING OPERATIONS
 MULTIPLE FLAGGERS
 TWO-LANE TWO-WAY ROADWAYS
 PRIMARY & SECONDARY ROUTES
 WORK ACTIVITY AREA
 TERMINATING at an
 INTERSECTION with a
 TWO-LANE TWO-WAY ROADWAY
 APPROACH LANE
- DRAWING 405-01-E(1)**
DRAWING 405-01-E(2) - FLAGGING OPERATIONS
 MULTIPLE FLAGGERS
 TWO-LANE TWO-WAY ROADWAYS
 PRIMARY & SECONDARY ROUTES
 WORK ACTIVITY AREA
 INTERSECTIONS with
 LOW SPEED
 < / = 35 MPH
 MULTILANE ROADWAYS
- DRAWING 405-01-F(1)**
DRAWING 405-01-F(2) - FLAGGING OPERATIONS
 MULTIPLE FLAGGERS
 TWO-LANE TWO-WAY ROADWAYS
 PRIMARY & SECONDARY ROUTES
 WORK ACTIVITY AREA
 INTERSECTIONS with
 INTERMEDIATE SPEED to HIGH SPEED
 40 MPH - 60 MPH
 MULTILANE ROADWAYS

- DRAWING 405-02** - FLAGGING OPERATIONS
SINGLE FLAGGER OPERATION
LOW VOLUME
LOW SPEED TO INTERMEDIATE SPEED
TWO-LANE TWO-WAY ROADWAYS
PRIMARY & SECONDARY ROUTES

SHOULDER CLOSURES

- DRAWING 515-01-A** - RIGHT SHOULDER CLOSURE
CASE I / CASE II
TWO-LANE TWO-WAY ROADWAYS
PRIMARY & SECONDARY ROUTES
- DRAWING 515-01-C** - RIGHT SHOULDER CLOSURE
LOW SPEED
< / = 35 MPH
PRIMARY & SECONDARY ROUTES
(MINOR ENCROACHMENT)

MOBILE OPERATIONS – INTERMITTENT

- DRAWING 535-01-A** - MOBILE OPERATIONS – INTERMITTENT
STOPPING SIGHT DISTANCE
VEHICLE TRAIN REQUIREMENTS
VERTICAL CURVE (HILL)
- DRAWING 535-01-B** - MOBILE OPERATIONS – INTERMITTENT
STOPPING SIGHT DISTANCE
VEHICLE TRAIN REQUIREMENTS
HORIZONTAL CURVE (CURVE)
- DRAWING 535-02-A** - MOBILE OPERATIONS – INTERMITTENT
LOW VOLUME
LOW SPEED
PRIMARY & SECONDARY ROUTES
- DRAWING 535-02-B** - MOBILE OPERATIONS – INTERMITTENT
LOW VOLUME
INTERMEDIATE SPEED TO HIGH SPEED
PRIMARY & SECONDARY ROUTES
- DRAWING 535-03-A** - MOBILE OPERATIONS – INTERMITTENT
INTERMEDIATE VOLUME
LOW SPEED
PRIMARY & SECONDARY ROUTES
- DRAWING 535-03-B** - MOBILE OPERATIONS – INTERMITTENT
INTERMEDIATE VOLUME
INTERMEDIATE SPEED TO HIGH SPEED
PRIMARY & SECONDARY ROUTES
- DRAWING 535-04-A** - MOBILE OPERATIONS – INTERMITTENT
HIGH VOLUME
LOW SPEED
PRIMARY & SECONDARY ROUTES
- DRAWING 535-04-C** - MOBILE OPERATIONS – INTERMITTENT
HIGH VOLUME
INTERMEDIATE SPEED TO HIGH SPEED
PRIMARY & SECONDARY ROUTES

MULTILANE SECONDARY AND PRIMARY ROADWAYS

On low speed roadways with speeds of 35 mph or less, shoulder closures designed for minor encroachment are acceptable for work activities conducted within 30 feet of the near edge of an adjacent travel lane that may require encroachment upon the roadway by personnel, tools, equipment, materials, vehicles, etc. to the extent that may require a reduction of the lane width of an adjacent travel lane to no less than 10 feet.

On low speed roadways with speeds of 35 mph or less, standard shoulder closures are required for work activities that require the presence of personnel, tools, equipment, materials, vehicles, etc. beyond 1 foot but within 30 feet of the near edge of an adjacent travel lane.

On intermediate to high speed roadways, standard shoulder closures are required for work activities that require the presence of personnel, tools, equipment, materials, vehicles, etc. beyond 1 foot but within 30 feet of the near edge of an adjacent travel lane.

On intermediate to high speed roadways, lane closures are required when the work activities require the presence of personnel, tools, equipment, materials, vehicles, etc. to encroach upon the roadway or to within 1 foot of the near edge of an adjacent travel lane.

For operations conducted by machine, implementation of intermittent mobile operations to conduct the work are acceptable under the following conditions:

Condition 1 - The maximum time duration of a stop is 15 minutes if the work vehicle and/or the shadow vehicle encroach upon a travel lane more than 2 feet.

Condition 2 - The maximum time duration of a stop is 30 minutes if the work vehicle and/or the shadow vehicle encroach upon a travel lane 2 feet or less.

During intermittent mobile operations, utilize a shadow vehicle when the stopping sight distance interval between the work vehicle or road machinery and an approaching motorist is unavailable based upon the posted regulatory speed limit of the work location.

Lane closures are required for work activities that cannot be conducted under the conditions required for standard shoulder closures, shoulder closures with minor encroachment or intermittent mobile operations.

TYPICAL DRAWING APPLICATIONS

LANE CLOSURES

DRAWING 505-01	-	LANE CLOSURE LOW SPEED MULTILANE < / = 35 MPH PRIMARY & SECONDARY ROUTES
DRAWING 505-02	-	DUAL LANE CLOSURE LOW SPEED MULTILANE < / = 35 MPH PRIMARY & SECONDARY ROUTES
DRAWING 505-03-A	-	LANE CLOSURE INTERMEDIATE SPEED TO HIGH SPEED 40 MPH - 60 MPH MULTILANE PRIMARY & SECONDARY ROUTES
DRAWING 505-04-A	-	DUAL LANE CLOSURE TRANSITION / ACTIVITY AREAS INTERMEDIATE SPEED TO HIGH SPEED 40 MPH - 60 MPH MULTILANE PRIMARY & SECONDARY ROUTES

DRAWING 505-04-B - DUAL LANE CLOSURE
ADVANCE WARNING AREA
INTERMEDIATE SPEED TO HIGH SPEED
40 MPH - 60 MPH
MULTILANE
PRIMARY & SECONDARY ROUTES

SHOULDER CLOSURES

DRAWING 515-01-B - RIGHT SHOULDER CLOSURE
CASE I / CASE II
MULTILANE
PRIMARY & SECONDARY ROUTES

DRAWING 515-01-C - RIGHT SHOULDER CLOSURE
LOW SPEED
< / = 35 MPH
PRIMARY & SECONDARY ROUTES
(MINOR ENCROACHMENT)

DRAWING 515-01-D - LEFT SHOULDER CLOSURE
LOW SPEED
< / = 35 MPH
MULTILANE DIVIDED HIGHWAY
w/ GRASSED EARTH MEDIAN
PRIMARY & SECONDARY ROUTES
(MINOR ENCROACHMENT)

DRAWING 515-02 - LEFT SHOULDER CLOSURE
CASE I / CASE I
MULTILANE
PRIMARY & SECONDARY ROUTES

DRAWING 515-03 - LEFT SHOULDER CLOSURE
CASE I / CASE II
MULTILANE
PRIMARY & SECONDARY ROUTES

MOBILE OPERATIONS – INTERMITTENT

DRAWING 535-01-A - MOBILE OPERATIONS – INTERMITTENT
STOPPING SIGHT DISTANCE
VEHICLE TRAIN REQUIREMENTS
VERTICAL CURVE (HILL)

DRAWING 535-01-B - MOBILE OPERATIONS – INTERMITTENT
STOPPING SIGHT DISTANCE
VEHICLE TRAIN REQUIREMENTS
HORIZONTAL CURVE (CURVE)

DRAWING 535-03-A - MOBILE OPERATIONS – INTERMITTENT
INTERMEDIATE VOLUME
LOW SPEED
PRIMARY & SECONDARY ROUTES

DRAWING 535-03-B - MOBILE OPERATIONS – INTERMITTENT
INTERMEDIATE VOLUME
INTERMEDIATE SPEED TO HIGH SPEED
PRIMARY & SECONDARY ROUTES

DRAWING 535-04-A - MOBILE OPERATIONS – INTERMITTENT
HIGH VOLUME
LOW SPEED
PRIMARY & SECONDARY ROUTES

- DRAWING 535-04-B** - MOBILE OPERATIONS – INTERMITTENT
HIGH VOLUME
LOW SPEED
INTERIOR TRAVEL LANE OPERATIONS
PRIMARY & SECONDARY ROUTES
- DRAWING 535-04-C** - MOBILE OPERATIONS – INTERMITTENT
HIGH VOLUME
INTERMEDIATE SPEED TO HIGH SPEED
PRIMARY & SECONDARY ROUTES

INTERSTATE ROADWAYS

Lane closures are required for work activities that require equipment, personnel, materials, or any vehicles to encroach upon a travel lane or within 10 feet of a travel lane. When the work may be performed without the necessity for equipment, personnel, materials, or vehicles to encroach within 10 feet of the adjacent travel, utilize shoulder closures.

TYPICAL DRAWING APPLICATIONS

LANE CLOSURES

- DRAWING 510-01-A** - LANE CLOSURE
INTERSTATE ROUTES
- DRAWING 510-01-B** - LANE CLOSURE
EXIT / ENTRANCE RAMPS
INTERSTATE ROUTES

SHOULDER CLOSURES

- DRAWING 520-01** - RIGHT SHOULDER CLOSURE
CASE I / CASE II
INTERSTATE ROUTES
- DRAWING 520-02** - LEFT SHOULDER CLOSURE
CASE I / CASE I
NARROW MEDIAN
INTERSTATE ROUTES
- DRAWING 520-03** - LEFT SHOULDER CLOSURE
CASE I / CASE I
WIDE MEDIAN
INTERSTATE ROUTES
- DRAWING 520-04** - LEFT SHOULDER CLOSURE
CASE I / CASE II
WIDE MEDIAN
INTERSTATE ROUTES
- DRAWING 520-05** - LEFT SHOULDER CLOSURE
CASE II / CASE II
WIDE MEDIAN
INTERSTATE ROUTES

PERFORMANCE ACTIVITY 401

MOWING

WORK DESCRIPTION 1	Brush Management
WORK DESCRIPTION 2	Hand Trimming
WORK DESCRIPTION 3	Outdoor Advertising Window
WORK DESCRIPTION 4	Routine
WORK DESCRIPTION 5	Safety

401 MOWING

ACTIVITY DESCRIPTION

Mow vegetation by hand and machine as necessary.

WORK DESCRIPTION 1 Brush Management
WORK DESCRIPTION 2 Hand Trimming
WORK DESCRIPTION 3 Outdoor Advertising Window
WORK DESCRIPTION 5 Safety

TRAFFIC CONTROL

TWO-LANE TWO-WAY ROADWAYS

Mobilized shoulder operations may be implemented for work activities requiring only one (1) single equipment unit that progress along the roadway at a slow pace and may require equipment or vehicles to encroach upon a travel lane beyond 2 feet and at times may occupy the entire travel lane adjacent to the shoulder in which the work is being conducted.

Utilize a shadow vehicle when the stopping sight distance interval between the work vehicle or road machinery and an approaching motorist is unavailable based upon the posted regulatory speed limit of the work location.

Shoulder closures may be installed for work activities that require pedestrian workers to perform work activities beyond 1 foot but within 15 feet of a travel lane.

Flagging operations may be installed for work activities that require pedestrian workers to encroach upon the travel lane or perform work activities within 1 foot of the adjacent travel lane.

Flagging operations may be installed for work activities that require equipment or any vehicles to encroach upon a travel lane beyond 2 feet and at times may occupy the entire travel lane adjacent to the shoulder in which the work is being conducted.

(Brief periodic encroachments upon the adjacent travel lane for the equipment to relocate or bypass structures such as guardrail locations or bridge structures are acceptable.)

TYPICAL DRAWING APPLICATIONS

FLAGGING OPERATIONS

DRAWING 405-01-A	-	FLAGGING OPERATIONS MULTIPLE FLAGGERS TWO-LANE TWO-WAY ROADWAYS PRIMARY & SECONDARY ROUTES
DRAWING 405-01-B(1)	-	FLAGGING OPERATIONS MULTIPLE FLAGGERS TWO-LANE TWO-WAY ROADWAYS PRIMARY & SECONDARY ROUTES STOP SIGN CONTROLLED SIDE ROADS
DRAWING 405-01-B(2)	-	FLAGGING OPERATIONS MULTIPLE FLAGGERS TWO-LANE TWO-WAY ROADWAYS PRIMARY & SECONDARY ROUTES 4-WAY STOP CONTROLLED INTERSECTION
DRAWING 405-01-C(1)	-	FLAGGING OPERATIONS MULTIPLE FLAGGERS TWO-LANE TWO-WAY ROADWAYS PRIMARY & SECONDARY ROUTES TRAFFIC SIGNAL CONTROLLED INTERSECTION LAW ENFORCEMENT OFFICER(S)

DRAWING 405-01-C(2) - FLAGGING OPERATIONS
MULTIPLE FLAGGERS
TWO-LANE TWO-WAY ROADWAYS
PRIMARY & SECONDARY ROUTES
TRAFFIC SIGNAL CONTROLLED INTERSECTION
FLAGGERS

DRAWING 405-01-D(1) - FLAGGING OPERATIONS
MULTIPLE FLAGGERS
TWO-LANE TWO-WAY ROADWAYS
PRIMARY & SECONDARY ROUTES
WORK ACTIVITY AREA
BEGINNING at an
INTERSECTION with a
TWO-LANE TWO-WAY ROADWAY
DEPARTURE LANE

DRAWING 405-01-D(2) - FLAGGING OPERATIONS
MULTIPLE FLAGGERS
TWO-LANE TWO-WAY ROADWAYS
PRIMARY & SECONDARY ROUTES
WORK ACTIVITY AREA
TERMINATING at an
INTERSECTION with a
TWO-LANE TWO-WAY ROADWAY
APPROACH LANE

DRAWING 405-01-E(1)
DRAWING 405-01-E(2) - FLAGGING OPERATIONS
MULTIPLE FLAGGERS
TWO-LANE TWO-WAY ROADWAYS
PRIMARY & SECONDARY ROUTES
WORK ACTIVITY AREA
INTERSECTIONS with
LOW SPEED
< / = 35 MPH
MULTILANE ROADWAYS

DRAWING 405-01-F(1)
DRAWING 405-01-F(2) - FLAGGING OPERATIONS
MULTIPLE FLAGGERS
TWO-LANE TWO-WAY ROADWAYS
PRIMARY & SECONDARY ROUTES
WORK ACTIVITY AREA
INTERSECTIONS with
INTERMEDIATE SPEED to HIGH SPEED
40 MPH - 60 MPH
MULTILANE ROADWAYS

DRAWING 405-02 - FLAGGING OPERATIONS
SINGLE FLAGGER OPERATION
LOW VOLUME
LOW SPEED TO INTERMEDIATE SPEED
TWO-LANE TWO-WAY ROADWAYS
PRIMARY & SECONDARY ROUTES

SHOULDER CLOSURES

DRAWING 515-01-A - RIGHT SHOULDER CLOSURE
CASE I / CASE II
TWO-LANE TWO-WAY ROADWAYS
PRIMARY & SECONDARY ROUTES

MOBILIZED SHOULDER OPERATIONS

- | | | |
|-----------------------|---|--|
| DRAWING 525-01 | - | MOBILIZED SHOULDER OPERATIONS
ROAD MACHINERY – MINOR ENCROACHMENT
PRIMARY & SECONDARY ROUTES |
| DRAWING 525-02 | - | MOBILIZED SHOULDER OPERATIONS
PEDESTRIAN WORKERS – NO ENCROACHMENT
ROAD MACHINERY – MINOR ENCROACHMENT
PRIMARY & SECONDARY ROUTES |
| DRAWING 525-03 | - | MOBILIZED SHOULDER OPERATIONS
ROAD MACHINERY – MAJOR ENCROACHMENT
PRIMARY & SECONDARY ROUTES |

MULTILANE SECONDARY AND PRIMARY ROADWAYS

Mobilized shoulder operations may be implemented for work activities requiring only one (1) single equipment unit that progress along the roadway at a slow pace and may require equipment or vehicles to encroach upon a travel lane beyond 2 feet and at times may occupy the entire travel lane adjacent to the shoulder in which the work is being conducted.

Utilize a shadow vehicle when the stopping sight distance interval between the work vehicle or road machinery and an approaching motorist is unavailable based upon the posted regulatory speed limit of the work location.

Shoulder closures may be installed for work activities that require pedestrian workers to perform work activities beyond 1 foot but within 15 feet of a travel lane.

Lane closures may be installed for work activities that require pedestrian workers to encroach upon the travel lane or perform work activities within 1 foot of the adjacent travel lane.

Lane closures may be installed for work activities that require equipment or any vehicles to encroach upon a travel lane beyond 2 feet and at times may occupy the entire travel lane adjacent to the shoulder in which the work is being conducted.

(Brief periodic encroachments upon the adjacent travel lane for the equipment to relocate or bypass structures such as guardrail locations or bridge structures are acceptable.)

TYPICAL DRAWING APPLICATIONS

LANE CLOSURES

- | | | |
|-------------------------|---|--|
| DRAWING 505-01 | - | LANE CLOSURE
LOW SPEED MULTILANE
< / = 35 MPH
PRIMARY & SECONDARY ROUTES |
| DRAWING 505-03-A | - | LANE CLOSURE
INTERMEDIATE SPEED TO HIGH SPEED
40 MPH - 60 MPH
MULTILANE
PRIMARY & SECONDARY ROUTES |

SHOULDER CLOSURES

- DRAWING 515-01-B** - RIGHT SHOULDER CLOSURE
CASE I / CASE II
MULTILANE
PRIMARY & SECONDARY ROUTES
- DRAWING 515-02** - LEFT SHOULDER CLOSURE
CASE I / CASE I
MULTILANE
PRIMARY & SECONDARY ROUTES
- DRAWING 515-03** - LEFT SHOULDER CLOSURE
CASE I / CASE II
MULTILANE
PRIMARY & SECONDARY ROUTES

MOBILIZED SHOULDER OPERATIONS

- DRAWING 525-01** - MOBILIZED SHOULDER OPERATIONS
ROAD MACHINERY – MINOR ENCROACHMENT
PRIMARY & SECONDARY ROUTES
- DRAWING 525-02** - MOBILIZED SHOULDER OPERATIONS
PEDESTRIAN WORKERS – NO ENCROACHMENT
ROAD MACHINERY – MINOR ENCROACHMENT
PRIMARY & SECONDARY ROUTES
- DRAWING 525-03** - MOBILIZED SHOULDER OPERATIONS
ROAD MACHINERY – MAJOR ENCROACHMENT
PRIMARY & SECONDARY ROUTES

INTERSTATE ROADWAYS

Mobilized shoulder operations should be implemented for work activities that progress along the roadway at a slow pace and may require equipment or vehicles to encroach upon the adjacent paved shoulder within the limits specified by the typical drawing applications for interstate mobilized shoulder operations.

Standard shoulder closures are required for work activities that progress along the roadway at a slow pace and cannot be conducted under the conditions required for mobilized shoulder operations.

(Brief periodic encroachments upon the adjacent travel lane for the equipment to relocate or bypass structures such as guardrail locations or bridge structures are acceptable.)

TYPICAL DRAWING APPLICATIONS

SHOULDER CLOSURES

- | | | |
|-----------------------|---|--|
| DRAWING 520-01 | - | RIGHT SHOULDER CLOSURE
CASE I / CASE II
INTERSTATE ROUTES |
| DRAWING 520-02 | - | LEFT SHOULDER CLOSURE
CASE I / CASE I
NARROW MEDIAN
INTERSTATE ROUTES |
| DRAWING 520-03 | - | LEFT SHOULDER CLOSURE
CASE I / CASE I
WIDE MEDIAN
INTERSTATE ROUTES |
| DRAWING 520-04 | - | LEFT SHOULDER CLOSURE
CASE I / CASE II
WIDE MEDIAN
INTERSTATE ROUTES |
| DRAWING 520-05 | - | LEFT SHOULDER CLOSURE
CASE II / CASE II
WIDE MEDIAN
INTERSTATE ROUTES |

MOBILIZED SHOULDER OPERATIONS

- | | | |
|-----------------------|---|--|
| DRAWING 530-01 | - | MOBILIZED SHOULDER OPERATIONS
ROAD MACHINERY – MAJOR ENCROACHMENT
INTERSTATE ROUTES |
| DRAWING 530-02 | - | MOBILIZED SHOULDER OPERATIONS
PEDESTRIAN WORKERS – MINOR ENCROACHMENT
UPON PAVED SHOULDER
INTERSTATE ROUTES |

WORK DESCRIPTION 4 Routine

TRAFFIC CONTROL

TWO-LANE TWO-WAY ROADWAYS

Mobilized shoulder operations may be implemented for work activities requiring only one (1) single equipment unit conducted within the roadway shoulders that move continuously while performing the work. Equipment for these operations occupies the shoulder while continuously moving. The equipment may encroach upon the adjacent travel lane up to 2 feet and possibly more than 2 feet for short durations.

Utilize a shadow vehicle when the stopping sight distance interval between the work vehicle or road machinery and an approaching motorist is unavailable based upon the posted regulatory speed limit of the work location.

(Brief periodic encroachments upon the adjacent travel lane for the equipment to relocate or bypass structures such as guardrail locations or bridge structures are acceptable.)

TYPICAL DRAWING APPLICATIONS

MOBILIZED SHOULDER OPERATIONS

DRAWING 525-01	-	MOBILIZED SHOULDER OPERATIONS ROAD MACHINERY – MINOR ENCROACHMENT PRIMARY & SECONDARY ROUTES
DRAWING 525-02	-	MOBILIZED SHOULDER OPERATIONS PEDESTRIAN WORKERS – NO ENCROACHMENT ROAD MACHINERY – MINOR ENCROACHMENT PRIMARY & SECONDARY ROUTES
DRAWING 525-03	-	MOBILIZED SHOULDER OPERATIONS ROAD MACHINERY – MAJOR ENCROACHMENT PRIMARY & SECONDARY ROUTES

MULTILANE SECONDARY AND PRIMARY ROADWAYS

Mobilized shoulder operations may be implemented for work activities requiring only one (1) single equipment unit conducted within the roadway shoulders that move continuously while performing the work. Equipment for these operations occupies the shoulder while continuously moving. The equipment may encroach upon the adjacent travel lane up to 2 feet and possibly more than 2 feet for short durations.

Utilize a shadow vehicle when the stopping sight distance interval between the work vehicle or road machinery and an approaching motorist is unavailable based upon the posted regulatory speed limit of the work location.

(Brief periodic encroachments upon the adjacent travel lane for the equipment to relocate or bypass structures such as guardrail locations or bridge structures are acceptable.)

TYPICAL DRAWING APPLICATIONS

MOBILIZED SHOULDER OPERATIONS

DRAWING 525-01	-	MOBILIZED SHOULDER OPERATIONS ROAD MACHINERY – MINOR ENCROACHMENT PRIMARY & SECONDARY ROUTES
-----------------------	---	--

- DRAWING 525-02** - MOBILIZED SHOULDER OPERATIONS
PEDESTRIAN WORKERS – NO ENCROACHMENT
ROAD MACHINERY – MINOR ENCROACHMENT
PRIMARY & SECONDARY ROUTES
- DRAWING 525-03** - MOBILIZED SHOULDER OPERATIONS
ROAD MACHINERY – MAJOR ENCROACHMENT
PRIMARY & SECONDARY ROUTES

INTERSTATE ROADWAYS

Mobilized shoulder operations should be implemented for work activities that require equipment, personnel, materials, or any vehicles to encroach upon the adjacent paved shoulder within the limits specified by the typical drawing applications for interstate mobilized shoulder operations.

Standard shoulder closures are required for work activities that progress along the roadway at a slow pace and cannot be conducted under the conditions required for mobilized shoulder operations.

(Brief periodic encroachments upon the adjacent travel lane for the equipment to relocate or bypass structures such as guardrail locations or bridge structures are acceptable.)

TYPICAL DRAWING APPLICATIONS

SHOULDER CLOSURES

- DRAWING 520-01** - RIGHT SHOULDER CLOSURE
CASE I / CASE II
INTERSTATE ROUTES
- DRAWING 520-02** - LEFT SHOULDER CLOSURE
CASE I / CASE I
NARROW MEDIAN
INTERSTATE ROUTES
- DRAWING 520-03** - LEFT SHOULDER CLOSURE
CASE I / CASE I
WIDE MEDIAN
INTERSTATE ROUTES
- DRAWING 520-04** - LEFT SHOULDER CLOSURE
CASE I / CASE II
WIDE MEDIAN
INTERSTATE ROUTES
- DRAWING 520-05** - LEFT SHOULDER CLOSURE
CASE II / CASE II
WIDE MEDIAN
INTERSTATE ROUTES

MOBILIZED SHOULDER OPERATIONS

- DRAWING 530-01** - MOBILIZED SHOULDER OPERATIONS
ROAD MACHINERY – MAJOR ENCROACHMENT
INTERSTATE ROUTES
- DRAWING 530-02** - MOBILIZED SHOULDER OPERATIONS
PEDESTRIAN WORKERS – MINOR ENCROACHMENT
UPON PAVED SHOULDER
INTERSTATE ROUTES

PERFORMANCE ACTIVITY 402

HERBICIDE APPLICATION

WORK DESCRIPTION 1	Total Vegetation Control
WORK DESCRIPTION 2	Brush
WORK DESCRIPTION 3	Trees
WORK DESCRIPTION 4	Broadleaf Weeds
WORK DESCRIPTION 5	Grassy Weeds
WORK DESCRIPTION 6	Turf

402 HERBICIDE APPLICATION

ACTIVITY DESCRIPTION

Apply herbicides to control undesirable vegetation.

WORK DESCRIPTION 1 Total Vegetation Control
WORK DESCRIPTION 2 Brush
WORK DESCRIPTION 3 Trees
WORK DESCRIPTION 4 Broadleaf Weeds
WORK DESCRIPTION 5 Grassy Weeds
WORK DESCRIPTION 6 Turf

TRAFFIC CONTROL

TWO-LANE TWO-WAY ROADWAYS

Utilize intermittent mobile operations for these work activities under the following conditions:

Condition 1 - The maximum time duration of a stop is 15 minutes if the work vehicle and/or the shadow vehicle encroach upon a travel lane more than 2 feet.

Condition 2 - The maximum time duration of a stop is 30 minutes if the work vehicle and/or the shadow vehicle encroach upon a travel lane 2 feet or less.

During intermittent mobile operations, utilize a shadow vehicle when the stopping sight distance interval between the work vehicle or road machinery and an approaching motorist is unavailable based upon the posted regulatory speed limit of the work location.

Flagging operations are required for work activities that cannot be conducted under the conditions required for intermittent mobile operations.

TYPICAL DRAWING APPLICATIONS

FLAGGING OPERATIONS

- | | | |
|----------------------------|---|---|
| DRAWING 405-01-A | - | FLAGGING OPERATIONS
MULTIPLE FLAGGERS
TWO-LANE TWO-WAY ROADWAYS
PRIMARY & SECONDARY ROUTES |
| DRAWING 405-01-B(1) | - | FLAGGING OPERATIONS
MULTIPLE FLAGGERS
TWO-LANE TWO-WAY ROADWAYS
PRIMARY & SECONDARY ROUTES
STOP SIGN CONTROLLED SIDE ROADS |
| DRAWING 405-01-B(2) | - | FLAGGING OPERATIONS
MULTIPLE FLAGGERS
TWO-LANE TWO-WAY ROADWAYS
PRIMARY & SECONDARY ROUTES
4-WAY STOP CONTROLLED INTERSECTION |
| DRAWING 405-01-C(1) | - | FLAGGING OPERATIONS
MULTIPLE FLAGGERS
TWO-LANE TWO-WAY ROADWAYS
PRIMARY & SECONDARY ROUTES
TRAFFIC SIGNAL CONTROLLED INTERSECTION
LAW ENFORCEMENT OFFICER(S) |
| DRAWING 405-01-C(2) | - | FLAGGING OPERATIONS
MULTIPLE FLAGGERS
TWO-LANE TWO-WAY ROADWAYS
PRIMARY & SECONDARY ROUTES
TRAFFIC SIGNAL CONTROLLED INTERSECTION
FLAGGERS |

- DRAWING 405-01-D(1)** - FLAGGING OPERATIONS
 MULTIPLE FLAGGERS
 TWO-LANE TWO-WAY ROADWAYS
 PRIMARY & SECONDARY ROUTES
 WORK ACTIVITY AREA
 BEGINNING at an
 INTERSECTION with a
 TWO-LANE TWO-WAY ROADWAY
 DEPARTURE LANE
- DRAWING 405-01-D(2)** - FLAGGING OPERATIONS
 MULTIPLE FLAGGERS
 TWO-LANE TWO-WAY ROADWAYS
 PRIMARY & SECONDARY ROUTES
 WORK ACTIVITY AREA
 TERMINATING at an
 INTERSECTION with a
 TWO-LANE TWO-WAY ROADWAY
 APPROACH LANE
- DRAWING 405-01-E(1)**
DRAWING 405-01-E(2) - FLAGGING OPERATIONS
 MULTIPLE FLAGGERS
 TWO-LANE TWO-WAY ROADWAYS
 PRIMARY & SECONDARY ROUTES
 WORK ACTIVITY AREA
 INTERSECTIONS with
 LOW SPEED
 < / = 35 MPH
 MULTILANE ROADWAYS
- DRAWING 405-01-F(1)**
DRAWING 405-01-F(2) - FLAGGING OPERATIONS
 MULTIPLE FLAGGERS
 TWO-LANE TWO-WAY ROADWAYS
 PRIMARY & SECONDARY ROUTES
 WORK ACTIVITY AREA
 INTERSECTIONS with
 INTERMEDIATE SPEED to HIGH SPEED
 40 MPH - 60 MPH
 MULTILANE ROADWAYS
- DRAWING 405-02** - FLAGGING OPERATIONS
 SINGLE FLAGGER OPERATION
 LOW VOLUME
 LOW SPEED TO INTERMEDIATE SPEED
 TWO-LANE TWO-WAY ROADWAYS
 PRIMARY & SECONDARY ROUTES

MOBILE OPERATIONS – INTERMITTENT

- DRAWING 535-01-A** - MOBILE OPERATIONS – INTERMITTENT
 STOPPING SIGHT DISTANCE
 VEHICLE TRAIN REQUIREMENTS
 VERTICAL CURVE (HILL)
- DRAWING 535-01-B** - MOBILE OPERATIONS – INTERMITTENT
 STOPPING SIGHT DISTANCE
 VEHICLE TRAIN REQUIREMENTS
 HORIZONTAL CURVE (CURVE)
- DRAWING 535-02-A** - MOBILE OPERATIONS – INTERMITTENT
 LOW VOLUME
 LOW SPEED
 PRIMARY & SECONDARY ROUTES

- DRAWING 535-02-B** - MOBILE OPERATIONS – INTERMITTENT
LOW VOLUME
INTERMEDIATE SPEED TO HIGH SPEED
PRIMARY & SECONDARY ROUTES
- DRAWING 535-03-A** - MOBILE OPERATIONS – INTERMITTENT
INTERMEDIATE VOLUME
LOW SPEED
PRIMARY & SECONDARY ROUTES
- DRAWING 535-03-B** - MOBILE OPERATIONS – INTERMITTENT
INTERMEDIATE VOLUME
INTERMEDIATE SPEED TO HIGH SPEED
PRIMARY & SECONDARY ROUTES
- DRAWING 535-04-A** - MOBILE OPERATIONS – INTERMITTENT
HIGH VOLUME
LOW SPEED
PRIMARY & SECONDARY ROUTES
- DRAWING 535-04-B** - MOBILE OPERATIONS – INTERMITTENT
HIGH VOLUME
LOW SPEED
INTERIOR TRAVEL LANE OPERATIONS
PRIMARY & SECONDARY ROUTES
- DRAWING 535-04-C** - MOBILE OPERATIONS – INTERMITTENT
HIGH VOLUME
INTERMEDIATE SPEED TO HIGH SPEED
PRIMARY & SECONDARY ROUTES

MULTILANE SECONDARY AND PRIMARY ROADWAYS

Utilize intermittent mobile operations for these work activities under the following conditions:

Condition 1 - The maximum time duration of a stop is 15 minutes if the work vehicle and/or the shadow vehicle encroach upon a travel lane more than 2 feet.

Condition 2 - The maximum time duration of a stop is 30 minutes if the work vehicle and/or the shadow vehicle encroach upon a travel lane 2 feet or less.

During intermittent mobile operations, utilize a shadow vehicle when the stopping sight distance interval between the work vehicle or road machinery and an approaching motorist is unavailable based upon the posted regulatory speed limit of the work location.

TYPICAL DRAWING APPLICATIONS

MOBILE OPERATIONS – INTERMITTENT

- DRAWING 535-01-A** - MOBILE OPERATIONS – INTERMITTENT
STOPPING SIGHT DISTANCE
VEHICLE TRAIN REQUIREMENTS
VERTICAL CURVE (HILL)
- DRAWING 535-01-B** - MOBILE OPERATIONS – INTERMITTENT
STOPPING SIGHT DISTANCE
VEHICLE TRAIN REQUIREMENTS
HORIZONTAL CURVE (CURVE)
- DRAWING 535-03-A** - MOBILE OPERATIONS – INTERMITTENT
INTERMEDIATE VOLUME
LOW SPEED
PRIMARY & SECONDARY ROUTES

- DRAWING 535-03-B** - MOBILE OPERATIONS – INTERMITTENT
INTERMEDIATE VOLUME
INTERMEDIATE SPEED TO HIGH SPEED
PRIMARY & SECONDARY ROUTES
- DRAWING 535-04-A** - MOBILE OPERATIONS – INTERMITTENT
HIGH VOLUME
LOW SPEED
PRIMARY & SECONDARY ROUTES
- DRAWING 535-04-B** - MOBILE OPERATIONS – INTERMITTENT
HIGH VOLUME
LOW SPEED
INTERIOR TRAVEL LANE OPERATIONS
PRIMARY & SECONDARY ROUTES
- DRAWING 535-04-C** - MOBILE OPERATIONS – INTERMITTENT
HIGH VOLUME
INTERMEDIATE SPEED TO HIGH SPEED
PRIMARY & SECONDARY ROUTES

INTERSTATE ROADWAYS

Utilize intermittent mobile operations for these work activities under the following conditions:

Condition 1 - The maximum time duration of a stop is 5 minutes if the work vehicle and/or the shadow vehicle encroach upon an adjacent travel lane due to a shoulder area inadequate to accommodate a vehicle in its entirety due to the presence of a concrete median barrier wall or a bridge parapet wall.

Condition 2 - The maximum time duration of a stop is 30 minutes if the vehicles remain in the shoulder areas in their entirety with no encroachment upon an adjacent travel lane.

During intermittent mobile operations, utilize a shadow vehicle when the stopping sight distance interval between the work vehicle or road machinery and an approaching motorist is unavailable based upon the posted regulatory speed limit of the work location.

TYPICAL DRAWING APPLICATIONS

MOBILE OPERATIONS – INTERMITTENT

- DRAWING 535-01-A** - MOBILE OPERATIONS – INTERMITTENT
STOPPING SIGHT DISTANCE
VEHICLE TRAIN REQUIREMENTS
VERTICAL CURVE (HILL)
- DRAWING 535-01-B** - MOBILE OPERATIONS – INTERMITTENT
STOPPING SIGHT DISTANCE
VEHICLE TRAIN REQUIREMENTS
HORIZONTAL CURVE (CURVE)
- DRAWING 535-04-D(1)** - MOBILE OPERATIONS – INTERMITTENT
HIGH VOLUME
HIGH SPEED
INTERSTATE ROUTES
- DRAWING 535-04-E** - MOBILE OPERATIONS – INTERMITTENT
HIGH VOLUME
HIGH SPEED
INTERIOR TRAVEL LANE OPERATIONS
INTERSTATE ROUTES

PERFORMANCE ACTIVITY 403

GRASSING

403 GRASSING

ACTIVITY DESCRIPTION

Prepare seed beds and plant grass seed or place sod.

TRAFFIC CONTROL

TWO-LANE TWO-WAY ROADWAYS

Mobilized shoulder operations may be used for work activities requiring only one (1) single equipment unit that progress along the roadway at a slow pace and require road machinery operating on the shoulder to encroach upon the roadway.

On low speed roadways with speeds of 35 mph or less, shoulder closures designed for minor encroachment are acceptable for work activities conducted within 30 feet of the near edge of an adjacent travel lane that may require encroachment upon the roadway by personnel, tools, equipment, materials, vehicles, etc. to the extent that may require a reduction of the lane width of an adjacent travel lane to no less than 10 feet.

On low speed roadways with speeds of 35 mph or less, standard shoulder closures are required for work activities that require the presence of personnel, tools, equipment, materials, vehicles, etc. beyond 1 foot but within 30 feet of the near edge of an adjacent travel lane.

On intermediate to high speed roadways, standard shoulder closures are required for work activities that require the presence of personnel, tools, equipment, materials, vehicles, etc. beyond 1 foot but within 30 feet of the near edge of an adjacent travel lane.

On intermediate to high speed roadways, flagging operations are required when the work activities require the presence of personnel, tools, equipment, materials, vehicles, etc. to encroach upon the roadway or to within 1 foot of the near edge of an adjacent travel lane.

Flagging operations are required for work activities that cannot be conducted under the conditions required for mobilized shoulder operations, standard shoulder closures or shoulder closures with minor encroachment.

TYPICAL DRAWING APPLICATIONS

FLAGGING OPERATIONS

DRAWING 405-01-A	-	FLAGGING OPERATIONS MULTIPLE FLAGGERS TWO-LANE TWO-WAY ROADWAYS PRIMARY & SECONDARY ROUTES
DRAWING 405-01-B(1)	-	FLAGGING OPERATIONS MULTIPLE FLAGGERS TWO-LANE TWO-WAY ROADWAYS PRIMARY & SECONDARY ROUTES STOP SIGN CONTROLLED SIDE ROADS
DRAWING 405-01-B(2)	-	FLAGGING OPERATIONS MULTIPLE FLAGGERS TWO-LANE TWO-WAY ROADWAYS PRIMARY & SECONDARY ROUTES 4-WAY STOP CONTROLLED INTERSECTION
DRAWING 405-01-C(1)	-	FLAGGING OPERATIONS MULTIPLE FLAGGERS TWO-LANE TWO-WAY ROADWAYS PRIMARY & SECONDARY ROUTES TRAFFIC SIGNAL CONTROLLED INTERSECTION LAW ENFORCEMENT OFFICER(S)

- DRAWING 405-01-C(2)** - FLAGGING OPERATIONS
MULTIPLE FLAGGERS
TWO-LANE TWO-WAY ROADWAYS
PRIMARY & SECONDARY ROUTES
TRAFFIC SIGNAL CONTROLLED INTERSECTION
FLAGGERS
- DRAWING 405-01-D(1)** - FLAGGING OPERATIONS
MULTIPLE FLAGGERS
TWO-LANE TWO-WAY ROADWAYS
PRIMARY & SECONDARY ROUTES
WORK ACTIVITY AREA
BEGINNING at an
INTERSECTION with a
TWO-LANE TWO-WAY ROADWAY
DEPARTURE LANE
- DRAWING 405-01-D(2)** - FLAGGING OPERATIONS
MULTIPLE FLAGGERS
TWO-LANE TWO-WAY ROADWAYS
PRIMARY & SECONDARY ROUTES
WORK ACTIVITY AREA
TERMINATING at an
INTERSECTION with a
TWO-LANE TWO-WAY ROADWAY
APPROACH LANE
- DRAWING 405-01-E(1)**
DRAWING 405-01-E(2) - FLAGGING OPERATIONS
MULTIPLE FLAGGERS
TWO-LANE TWO-WAY ROADWAYS
PRIMARY & SECONDARY ROUTES
WORK ACTIVITY AREA
INTERSECTIONS with
LOW SPEED
< / = 35 MPH
MULTILANE ROADWAYS
- DRAWING 405-01-F(1)**
DRAWING 405-01-F(2) - FLAGGING OPERATIONS
MULTIPLE FLAGGERS
TWO-LANE TWO-WAY ROADWAYS
PRIMARY & SECONDARY ROUTES
WORK ACTIVITY AREA
INTERSECTIONS with
INTERMEDIATE SPEED to HIGH SPEED
40 MPH - 60 MPH
MULTILANE ROADWAYS
- DRAWING 405-02** - FLAGGING OPERATIONS
SINGLE FLAGGER OPERATION
LOW VOLUME
LOW SPEED TO INTERMEDIATE SPEED
TWO-LANE TWO-WAY ROADWAYS
PRIMARY & SECONDARY ROUTES

SHOULDER CLOSURES

- DRAWING 515-01-A** - RIGHT SHOULDER CLOSURE
CASE I / CASE II
TWO-LANE TWO-WAY ROADWAYS
PRIMARY & SECONDARY ROUTES
- DRAWING 515-01-C** - RIGHT SHOULDER CLOSURE
LOW SPEED
< / = 35 MPH
PRIMARY & SECONDARY ROUTES
(MINOR ENCROACHMENT)

MOBILIZED SHOULDER OPERATIONS

- DRAWING 525-01** - MOBILIZED SHOULDER OPERATIONS
ROAD MACHINERY – MINOR ENCROACHMENT
PRIMARY & SECONDARY ROUTES
- DRAWING 525-02** - MOBILIZED SHOULDER OPERATIONS
PEDESTRIAN WORKERS – NO ENCROACHMENT
ROAD MACHINERY – MINOR ENCROACHMENT
PRIMARY & SECONDARY ROUTES
- DRAWING 525-03** - MOBILIZED SHOULDER OPERATIONS
ROAD MACHINERY – MAJOR ENCROACHMENT
PRIMARY & SECONDARY ROUTES

MULTILANE SECONDARY AND PRIMARY ROADWAYS

Mobilized shoulder operations may be implemented for work activities requiring only one (1) single equipment unit that progress along the roadway at a slow pace and may require equipment or vehicles to encroach upon a travel lane beyond 2 feet and at times may occupy the entire travel lane adjacent to the shoulder in which the work is being conducted.

On low speed roadways with speeds of 35 mph or less, shoulder closures designed for minor encroachment are acceptable for work activities conducted within 30 feet of the near edge of an adjacent travel lane that may require encroachment upon the roadway by personnel, tools, equipment, materials, vehicles, etc. to the extent that may require a reduction of the lane width of an adjacent travel lane to no less than 10 feet.

On low speed roadways with speeds of 35 mph or less, standard shoulder closures are required for work activities that require the presence of personnel, tools, equipment, materials, vehicles, etc. beyond 1 foot but within 30 feet of the near edge of an adjacent travel lane.

On low speed roadways, lane closures are required when encroachment of the work activities onto the roadway will reduce the lane width of the adjacent travel lane to less than 10 feet.

On intermediate to high speed roadways, standard shoulder closures are required for work activities that require the presence of personnel, tools, equipment, materials, vehicles, etc. beyond 1 foot but within 30 feet of the near edge of an adjacent travel lane.

On intermediate to high speed roadways, lane closures are required when the work activities require the presence of personnel, tools, equipment, materials, vehicles, etc. to encroach upon the roadway or to within 1 foot of the near edge of an adjacent travel lane.

Lane closures are required for work activities that cannot be conducted under the conditions required for mobilized shoulder operations, standard shoulder closures or shoulder closures with minor encroachment.

TYPICAL DRAWING APPLICATIONS

LANE CLOSURES

- DRAWING 505-01** - LANE CLOSURE
LOW SPEED MULTILANE
< / = 35 MPH
PRIMARY & SECONDARY ROUTES
- DRAWING 505-03-A** - LANE CLOSURE
INTERMEDIATE SPEED TO HIGH SPEED
40 MPH - 60 MPH
MULTILANE
PRIMARY & SECONDARY ROUTES

SHOULDER CLOSURES

- DRAWING 515-01-B** - RIGHT SHOULDER CLOSURE
CASE I / CASE II
MULTILANE
PRIMARY & SECONDARY ROUTES
- DRAWING 515-01-C** - RIGHT SHOULDER CLOSURE
LOW SPEED
< / = 35 MPH
PRIMARY & SECONDARY ROUTES
(MINOR ENCROACHMENT)
- DRAWING 515-01-D** - LEFT SHOULDER CLOSURE
LOW SPEED
< / = 35 MPH
MULTILANE DIVIDED HIGHWAY
w/ GRASSED EARTH MEDIAN
PRIMARY & SECONDARY ROUTES
(MINOR ENCROACHMENT)
- DRAWING 515-02** - LEFT SHOULDER CLOSURE
CASE I / CASE I
MULTILANE
PRIMARY & SECONDARY ROUTES
- DRAWING 515-03** - LEFT SHOULDER CLOSURE
CASE I / CASE II
MULTILANE
PRIMARY & SECONDARY ROUTES

MOBILIZED SHOULDER OPERATIONS

- DRAWING 525-01** - MOBILIZED SHOULDER OPERATIONS
ROAD MACHINERY – MINOR ENCROACHMENT
PRIMARY & SECONDARY ROUTES
- DRAWING 525-02** - MOBILIZED SHOULDER OPERATIONS
PEDESTRIAN WORKERS – NO ENCROACHMENT
ROAD MACHINERY – MINOR ENCROACHMENT
PRIMARY & SECONDARY ROUTES
- DRAWING 525-03** - MOBILIZED SHOULDER OPERATIONS
ROAD MACHINERY – MAJOR ENCROACHMENT
PRIMARY & SECONDARY ROUTES

INTERSTATE ROADWAYS

Standard shoulder closures may be used for short term stationary and longer term work zones with work activities that require the presence of equipment, personnel, materials, or any vehicles to beyond 10 feet but within 30 feet of an adjacent travel lane.

Lane closures are required for work activities that require equipment, personnel, materials, or any vehicles to encroach upon a travel lane or within 10 feet of a travel lane. When the work may be performed without the necessity for equipment, personnel, materials, or vehicles to encroach within 10 feet of the adjacent travel, utilize shoulder closures.

TYPICAL DRAWING APPLICATIONS

LANE CLOSURES

- DRAWING 510-01-A** - LANE CLOSURE
INTERSTATE ROUTES
- DRAWING 510-01-B** - LANE CLOSURE
EXIT / ENTRANCE RAMPS
INTERSTATE ROUTES

SHOULDER CLOSURES

- DRAWING 520-01** - RIGHT SHOULDER CLOSURE
CASE I / CASE II
INTERSTATE ROUTES
- DRAWING 520-02** - LEFT SHOULDER CLOSURE
CASE I / CASE I
NARROW MEDIAN
INTERSTATE ROUTES
- DRAWING 520-03** - LEFT SHOULDER CLOSURE
CASE I / CASE I
WIDE MEDIAN
INTERSTATE ROUTES
- DRAWING 520-04** - LEFT SHOULDER CLOSURE
CASE I / CASE II
WIDE MEDIAN
INTERSTATE ROUTES
- DRAWING 520-05** - LEFT SHOULDER CLOSURE
CASE II / CASE II
WIDE MEDIAN
INTERSTATE ROUTES

PERFORMANCE ACTIVITY 405

LIMB MANAGEMENT

405 LIMB MANAGEMENT

ACTIVITY DESCRIPTION

Cut and/or remove and/or grind tree limbs from the right-of-way.

TRAFFIC CONTROL

TWO-LANE TWO-WAY ROADWAYS

Utilize intermittent mobile operations for these work activities under the following conditions:

Condition 1 - The maximum time duration of a stop is 15 minutes if the work vehicle and/or the shadow vehicle encroach upon a travel lane more than 2 feet.

Condition 2 - The maximum time duration of a stop is 30 minutes if the work vehicle and/or the shadow vehicle encroach upon a travel lane 2 feet or less.

During intermittent mobile operations, utilize a shadow vehicle when the stopping sight distance interval between the work vehicle or road machinery and an approaching motorist is unavailable based upon the posted regulatory speed limit of the work location.

Mobilized shoulder operations may be used for work activities requiring only one (1) single equipment unit that progress along the roadway at a slow pace and require road machinery operating on the shoulder to encroach upon the roadway.

On low speed roadways with speeds of 35 mph or less, shoulder closures designed for minor encroachment are acceptable for work activities conducted within 30 feet of the near edge of an adjacent travel lane that may require encroachment upon the roadway by personnel, tools, equipment, materials, vehicles, etc. to the extent that may require a reduction of the lane width of an adjacent travel lane to no less than 10 feet.

On low speed roadways with speeds of 35 mph or less, standard shoulder closures are required for work activities that require the presence of personnel, tools, equipment, materials, vehicles, etc. beyond 1 foot but within 30 feet of the near edge of an adjacent travel lane.

On intermediate to high speed roadways, standard shoulder closures are required for work activities that require the presence of personnel, tools, equipment, materials, vehicles, etc. beyond 1 foot but within 30 feet of the near edge of an adjacent travel lane.

On intermediate to high speed roadways, flagging operations are required when the work activities require the presence of personnel, tools, equipment, materials, vehicles, etc. to encroach upon the roadway or to within 1 foot of the near edge of an adjacent travel lane.

Flagging operations are required for work activities that cannot be conducted under the conditions required for intermittent mobile operations, mobilized shoulder operations, standard shoulder closures or shoulder closures with minor encroachment.

TYPICAL DRAWING APPLICATIONS

FLAGGING OPERATIONS

- | | | |
|----------------------------|---|--|
| DRAWING 405-01-A | - | FLAGGING OPERATIONS
MULTIPLE FLAGGERS
TWO-LANE TWO-WAY ROADWAYS
PRIMARY & SECONDARY ROUTES |
| DRAWING 405-01-B(1) | - | FLAGGING OPERATIONS
MULTIPLE FLAGGERS
TWO-LANE TWO-WAY ROADWAYS
PRIMARY & SECONDARY ROUTES
STOP SIGN CONTROLLED SIDE ROADS |

- DRAWING 405-01-B(2)** - FLAGGING OPERATIONS
MULTIPLE FLAGGERS
TWO-LANE TWO-WAY ROADWAYS
PRIMARY & SECONDARY ROUTES
4-WAY STOP CONTROLLED INTERSECTION
- DRAWING 405-01-C(1)** - FLAGGING OPERATIONS
MULTIPLE FLAGGERS
TWO-LANE TWO-WAY ROADWAYS
PRIMARY & SECONDARY ROUTES
TRAFFIC SIGNAL CONTROLLED INTERSECTION
LAW ENFORCEMENT OFFICER(S)
- DRAWING 405-01-C(2)** - FLAGGING OPERATIONS
MULTIPLE FLAGGERS
TWO-LANE TWO-WAY ROADWAYS
PRIMARY & SECONDARY ROUTES
TRAFFIC SIGNAL CONTROLLED INTERSECTION
FLAGGERS
- DRAWING 405-01-D(1)** - FLAGGING OPERATIONS
MULTIPLE FLAGGERS
TWO-LANE TWO-WAY ROADWAYS
PRIMARY & SECONDARY ROUTES
WORK ACTIVITY AREA
BEGINNING at an
INTERSECTION with a
TWO-LANE TWO-WAY ROADWAY
DEPARTURE LANE
- DRAWING 405-01-D(2)** - FLAGGING OPERATIONS
MULTIPLE FLAGGERS
TWO-LANE TWO-WAY ROADWAYS
PRIMARY & SECONDARY ROUTES
WORK ACTIVITY AREA
TERMINATING at an
INTERSECTION with a
TWO-LANE TWO-WAY ROADWAY
APPROACH LANE
- DRAWING 405-01-E(1)**
DRAWING 405-01-E(2) - FLAGGING OPERATIONS
MULTIPLE FLAGGERS
TWO-LANE TWO-WAY ROADWAYS
PRIMARY & SECONDARY ROUTES
WORK ACTIVITY AREA
INTERSECTIONS with
LOW SPEED
< / = 35 MPH
MULTILANE ROADWAYS
- DRAWING 405-01-F(1)**
DRAWING 405-01-F(2) - FLAGGING OPERATIONS
MULTIPLE FLAGGERS
TWO-LANE TWO-WAY ROADWAYS
PRIMARY & SECONDARY ROUTES
WORK ACTIVITY AREA
INTERSECTIONS with
INTERMEDIATE SPEED to HIGH SPEED
40 MPH - 60 MPH
MULTILANE ROADWAYS

- DRAWING 405-02** - FLAGGING OPERATIONS
SINGLE FLAGGER OPERATION
LOW VOLUME
LOW SPEED TO INTERMEDIATE SPEED
TWO-LANE TWO-WAY ROADWAYS
PRIMARY & SECONDARY ROUTES

SHOULDER CLOSURES

- DRAWING 515-01-A** - RIGHT SHOULDER CLOSURE
CASE I / CASE II
TWO-LANE TWO-WAY ROADWAYS
PRIMARY & SECONDARY ROUTES
- DRAWING 515-01-C** - RIGHT SHOULDER CLOSURE
LOW SPEED
< / = 35 MPH
PRIMARY & SECONDARY ROUTES
(MINOR ENCROACHMENT)

MOBILIZED SHOULDER OPERATIONS

- DRAWING 525-01** - MOBILIZED SHOULDER OPERATIONS
ROAD MACHINERY – MINOR ENCROACHMENT
PRIMARY & SECONDARY ROUTES
- DRAWING 525-02** - MOBILIZED SHOULDER OPERATIONS
PEDESTRIAN WORKERS – NO ENCROACHMENT
ROAD MACHINERY – MINOR ENCROACHMENT
PRIMARY & SECONDARY ROUTES
- DRAWING 525-03** - MOBILIZED SHOULDER OPERATIONS
ROAD MACHINERY – MAJOR ENCROACHMENT
PRIMARY & SECONDARY ROUTES

MOBILE OPERATIONS – INTERMITTENT

- DRAWING 535-01-A** - MOBILE OPERATIONS – INTERMITTENT
STOPPING SIGHT DISTANCE
VEHICLE TRAIN REQUIREMENTS
VERTICAL CURVE (HILL)
- DRAWING 535-01-B** - MOBILE OPERATIONS – INTERMITTENT
STOPPING SIGHT DISTANCE
VEHICLE TRAIN REQUIREMENTS
HORIZONTAL CURVE (CURVE)
- DRAWING 535-02-A** - MOBILE OPERATIONS – INTERMITTENT
LOW VOLUME
LOW SPEED
PRIMARY & SECONDARY ROUTES
- DRAWING 535-02-B** - MOBILE OPERATIONS – INTERMITTENT
LOW VOLUME
INTERMEDIATE SPEED TO HIGH SPEED
PRIMARY & SECONDARY ROUTES
- DRAWING 535-03-A** - MOBILE OPERATIONS – INTERMITTENT
INTERMEDIATE VOLUME
LOW SPEED
PRIMARY & SECONDARY ROUTES

DRAWING 535-03-B	-	MOBILE OPERATIONS – INTERMITTENT INTERMEDIATE VOLUME INTERMEDIATE SPEED TO HIGH SPEED PRIMARY & SECONDARY ROUTES
DRAWING 535-04-A	-	MOBILE OPERATIONS – INTERMITTENT HIGH VOLUME LOW SPEED PRIMARY & SECONDARY ROUTES
DRAWING 535-04-B	-	MOBILE OPERATIONS – INTERMITTENT HIGH VOLUME LOW SPEED INTERIOR TRAVEL LANE OPERATIONS PRIMARY & SECONDARY ROUTES
DRAWING 535-04-C	-	MOBILE OPERATIONS – INTERMITTENT HIGH VOLUME INTERMEDIATE SPEED TO HIGH SPEED PRIMARY & SECONDARY ROUTES

MULTILANE SECONDARY AND PRIMARY ROADWAYS

Utilize intermittent mobile operations for these work activities under the following conditions:

Condition 1 - The maximum time duration of a stop is 15 minutes if the work vehicle and/or the shadow vehicle encroach upon a travel lane more than 2 feet.

Condition 2 - The maximum time duration of a stop is 30 minutes if the work vehicle and/or the shadow vehicle encroach upon a travel lane 2 feet or less.

During intermittent mobile operations, utilize a shadow vehicle when the stopping sight distance interval between the work vehicle or road machinery and an approaching motorist is unavailable based upon the posted regulatory speed limit of the work location.

Mobilized shoulder operations may be used for work activities requiring only one (1) single equipment unit that progress along the roadway at a slow pace and require road machinery operating on the shoulder to encroach upon the roadway.

On low speed roadways with speeds of 35 mph or less, shoulder closures designed for minor encroachment are acceptable for work activities conducted within 30 feet of the near edge of an adjacent travel lane that may require encroachment upon the roadway by personnel, tools, equipment, materials, vehicles, etc. to the extent that may require a reduction of the lane width of an adjacent travel lane to no less than 10 feet.

On low speed roadways with speeds of 35 mph or less, standard shoulder closures are required for work activities that require the presence of personnel, tools, equipment, materials, vehicles, etc. beyond 1 foot but within 30 feet of the near edge of an adjacent travel lane.

On low speed roadways, lane closures are required when encroachment of the work activities onto the roadway will reduce the lane width of the adjacent travel lane to less than 10 feet.

On intermediate to high speed roadways, standard shoulder closures are required for work activities that require the presence of personnel, tools, equipment, materials, vehicles, etc. beyond 1 foot but within 30 feet of the near edge of an adjacent travel lane.

On intermediate to high speed roadways, lane closures are required when the work activities require the presence of personnel, tools, equipment, materials, vehicles, etc. to encroach upon the roadway or to within 1 foot of the near edge of an adjacent travel lane.

Lane closures are required for work activities that cannot be conducted under the conditions required for intermittent mobile operations, mobilized shoulder operations, standard shoulder closures or shoulder closures with minor encroachment.

TYPICAL DRAWING APPLICATIONS

LANE CLOSURES

- DRAWING 505-01** - LANE CLOSURE
LOW SPEED MULTILANE
< / = 35 MPH
PRIMARY & SECONDARY ROUTES
- DRAWING 505-03-A** - LANE CLOSURE
INTERMEDIATE SPEED TO HIGH SPEED
40 MPH - 60 MPH
MULTILANE
PRIMARY & SECONDARY ROUTES

SHOULDER CLOSURES

- DRAWING 515-01-B** - RIGHT SHOULDER CLOSURE
CASE I / CASE II
MULTILANE
PRIMARY & SECONDARY ROUTES
- DRAWING 515-01-C** - RIGHT SHOULDER CLOSURE
LOW SPEED
< / = 35 MPH
PRIMARY & SECONDARY ROUTES
(MINOR ENCROACHMENT)
- DRAWING 515-01-D** - LEFT SHOULDER CLOSURE
LOW SPEED
< / = 35 MPH
MULTILANE DIVIDED HIGHWAY
w/ GRASSED EARTH MEDIAN
PRIMARY & SECONDARY ROUTES
(MINOR ENCROACHMENT)
- DRAWING 515-02** - LEFT SHOULDER CLOSURE
CASE I / CASE I
MULTILANE
PRIMARY & SECONDARY ROUTES
- DRAWING 515-03** - LEFT SHOULDER CLOSURE
CASE I / CASE II
MULTILANE
PRIMARY & SECONDARY ROUTES

MOBILIZED SHOULDER OPERATIONS

- DRAWING 525-01** - MOBILIZED SHOULDER OPERATIONS
ROAD MACHINERY – MINOR ENCROACHMENT
PRIMARY & SECONDARY ROUTES
- DRAWING 525-02** - MOBILIZED SHOULDER OPERATIONS
PEDESTRIAN WORKERS – NO ENCROACHMENT
ROAD MACHINERY – MINOR ENCROACHMENT
PRIMARY & SECONDARY ROUTES
- DRAWING 525-03** - MOBILIZED SHOULDER OPERATIONS
ROAD MACHINERY – MAJOR ENCROACHMENT
PRIMARY & SECONDARY ROUTES

MOBILE OPERATIONS – INTERMITTENT

- DRAWING 535-01-A** - MOBILE OPERATIONS – INTERMITTENT
STOPPING SIGHT DISTANCE
VEHICLE TRAIN REQUIREMENTS
VERTICAL CURVE (HILL)
- DRAWING 535-01-B** - MOBILE OPERATIONS – INTERMITTENT
STOPPING SIGHT DISTANCE
VEHICLE TRAIN REQUIREMENTS
HORIZONTAL CURVE (CURVE)
- DRAWING 535-03-A** - MOBILE OPERATIONS – INTERMITTENT
INTERMEDIATE VOLUME
LOW SPEED
PRIMARY & SECONDARY ROUTES
- DRAWING 535-03-B** - MOBILE OPERATIONS – INTERMITTENT
INTERMEDIATE VOLUME
INTERMEDIATE SPEED TO HIGH SPEED
PRIMARY & SECONDARY ROUTES
- DRAWING 535-04-A** - MOBILE OPERATIONS – INTERMITTENT
HIGH VOLUME
LOW SPEED
PRIMARY & SECONDARY ROUTES
- DRAWING 535-04-B** - MOBILE OPERATIONS – INTERMITTENT
HIGH VOLUME
LOW SPEED
INTERIOR TRAVEL LANE OPERATIONS
PRIMARY & SECONDARY ROUTES
- DRAWING 535-04-C** - MOBILE OPERATIONS – INTERMITTENT
HIGH VOLUME
INTERMEDIATE SPEED TO HIGH SPEED
PRIMARY & SECONDARY ROUTES

INTERSTATE ROADWAYS

Utilize intermittent mobile operations for these work activities under the following conditions:

Condition 1 - The maximum time duration of a stop is 5 minutes if the work vehicle and/or the shadow vehicle encroach upon an adjacent travel lane due to a shoulder area inadequate to accommodate a vehicle in its entirety due to the presence of a concrete median barrier wall or a bridge parapet wall.

Condition 2 - The maximum time duration of a stop is 30 minutes if the vehicles remain in the shoulder areas in their entirety with no encroachment upon an adjacent travel lane.

During intermittent mobile operations, utilize a shadow vehicle when the stopping sight distance interval between the work vehicle or road machinery and an approaching motorist is unavailable based upon the posted regulatory speed limit of the work location.

Mobilized shoulder operations may be used for work activities that progress along the roadway at a slow pace and require equipment, personnel, materials, or any vehicles to encroach upon the adjacent paved shoulder within the limits specified by the typical drawing applications for interstate mobilized shoulder operations.

Standard shoulder closures may be used for work activities that cannot be conducted under the conditions required for intermittent mobile operations or mobilized shoulder operations.

Lane closures are required for work activities that cannot be conducted under the conditions required for intermittent mobile operations, mobilized shoulder operations or standard shoulder closures.

(Brief periodic encroachments upon the adjacent travel lane for the equipment to relocate or bypass structures such as guardrail locations or bridge structures are acceptable.)

TYPICAL DRAWING APPLICATIONS

LANE CLOSURES

DRAWING 510-01-A - LANE CLOSURE
INTERSTATE ROUTES

DRAWING 510-01-B - LANE CLOSURE
EXIT / ENTRANCE RAMP
INTERSTATE ROUTES

SHOULDER CLOSURES

DRAWING 520-01 - RIGHT SHOULDER CLOSURE
CASE I / CASE II
INTERSTATE ROUTES

DRAWING 520-02 - LEFT SHOULDER CLOSURE
CASE I / CASE I
NARROW MEDIAN
INTERSTATE ROUTES

DRAWING 520-03 - LEFT SHOULDER CLOSURE
CASE I / CASE I
WIDE MEDIAN
INTERSTATE ROUTES

DRAWING 520-04 - LEFT SHOULDER CLOSURE
CASE I / CASE II
WIDE MEDIAN
INTERSTATE ROUTES

DRAWING 520-05 - LEFT SHOULDER CLOSURE
CASE II / CASE II
WIDE MEDIAN
INTERSTATE ROUTES

MOBILIZED SHOULDER OPERATIONS

- DRAWING 530-01** - MOBILIZED SHOULDER OPERATIONS
ROAD MACHINERY – MAJOR ENCROACHMENT
INTERSTATE ROUTES
- DRAWING 530-02** - MOBILIZED SHOULDER OPERATIONS
PEDESTRIAN WORKERS – MINOR ENCROACHMENT
UPON PAVED SHOULDER
INTERSTATE ROUTES

MOBILE OPERATIONS – INTERMITTENT

- DRAWING 535-01-A** - MOBILE OPERATIONS – INTERMITTENT
STOPPING SIGHT DISTANCE
VEHICLE TRAIN REQUIREMENTS
VERTICAL CURVE (HILL)
- DRAWING 535-01-B** - MOBILE OPERATIONS – INTERMITTENT
STOPPING SIGHT DISTANCE
VEHICLE TRAIN REQUIREMENTS
HORIZONTAL CURVE (CURVE)
- DRAWING 535-04-D(1)** - MOBILE OPERATIONS – INTERMITTENT
HIGH VOLUME
HIGH SPEED
INTERSTATE ROUTES
- DRAWING 535-04-E** - MOBILE OPERATIONS – INTERMITTENT
HIGH VOLUME
HIGH SPEED
INTERIOR TRAVEL LANE OPERATIONS
INTERSTATE ROUTES

PERFORMANCE ACTIVITY 406

BEAUTIFICATION

ACTIVITY DESCRIPTION

Maintain roadside landscape plots.

TRAFFIC CONTROL

TWO-LANE TWO-WAY ROADWAYS

Utilize intermittent mobile operations for these work activities under the following conditions:

Condition 1 - The maximum time duration of a stop is 15 minutes if the work vehicle and/or the shadow vehicle encroach upon a travel lane more than 2 feet.

Condition 2 - The maximum time duration of a stop is 30 minutes if the work vehicle and/or the shadow vehicle encroach upon a travel lane 2 feet or less.

During intermittent mobile operations, utilize a shadow vehicle when the stopping sight distance interval between the work vehicle or road machinery and an approaching motorist is unavailable based upon the posted regulatory speed limit of the work location.

Mobilized shoulder operations may be used for work activities requiring only one (1) single equipment unit that progress along the roadway at a slow pace and require road machinery operating on the shoulder to encroach upon the roadway.

On low speed roadways with speeds of 35 mph or less, shoulder closures designed for minor encroachment are acceptable for work activities conducted within 30 feet of the near edge of an adjacent travel lane that may require encroachment upon the roadway by personnel, tools, equipment, materials, vehicles, etc. to the extent that may require a reduction of the lane width of an adjacent travel lane to no less than 10 feet.

On low speed roadways with speeds of 35 mph or less, standard shoulder closures are required for work activities that require the presence of personnel, tools, equipment, materials, vehicles, etc. beyond 1 foot but within 30 feet of the near edge of an adjacent travel lane.

On intermediate to high speed roadways, standard shoulder closures are required for work activities that require the presence of personnel, tools, equipment, materials, vehicles, etc. beyond 1 foot but within 30 feet of the near edge of an adjacent travel lane.

On intermediate to high speed roadways, flagging operations are required when the work activities require the presence of personnel, tools, equipment, materials, vehicles, etc. to encroach upon the roadway or to within 1 foot of the near edge of an adjacent travel lane.

Flagging operations are required for work activities that cannot be conducted under the conditions required for intermittent mobile operations, mobilized shoulder operations or standard shoulder closures.

TYPICAL DRAWING APPLICATIONS

FLAGGING OPERATIONS

- DRAWING 405-01-A - FLAGGING OPERATIONS
MULTIPLE FLAGGERS
TWO-LANE TWO-WAY ROADWAYS
PRIMARY & SECONDARY ROUTES
- DRAWING 405-01-B(1) - FLAGGING OPERATIONS
MULTIPLE FLAGGERS
TWO-LANE TWO-WAY ROADWAYS
PRIMARY & SECONDARY ROUTES
STOP SIGN CONTROLLED SIDE ROADS

- DRAWING 405-01-B(2)** - FLAGGING OPERATIONS
MULTIPLE FLAGGERS
TWO-LANE TWO-WAY ROADWAYS
PRIMARY & SECONDARY ROUTES
4-WAY STOP CONTROLLED INTERSECTION
- DRAWING 405-01-C(1)** - FLAGGING OPERATIONS
MULTIPLE FLAGGERS
TWO-LANE TWO-WAY ROADWAYS
PRIMARY & SECONDARY ROUTES
TRAFFIC SIGNAL CONTROLLED INTERSECTION
LAW ENFORCEMENT OFFICER(S)
- DRAWING 405-01-C(2)** - FLAGGING OPERATIONS
MULTIPLE FLAGGERS
TWO-LANE TWO-WAY ROADWAYS
PRIMARY & SECONDARY ROUTES
TRAFFIC SIGNAL CONTROLLED INTERSECTION
FLAGGERS
- DRAWING 405-01-D(1)** - FLAGGING OPERATIONS
MULTIPLE FLAGGERS
TWO-LANE TWO-WAY ROADWAYS
PRIMARY & SECONDARY ROUTES
WORK ACTIVITY AREA
BEGINNING at an
INTERSECTION with a
TWO-LANE TWO-WAY ROADWAY
DEPARTURE LANE
- DRAWING 405-01-D(2)** - FLAGGING OPERATIONS
MULTIPLE FLAGGERS
TWO-LANE TWO-WAY ROADWAYS
PRIMARY & SECONDARY ROUTES
WORK ACTIVITY AREA
TERMINATING at an
INTERSECTION with a
TWO-LANE TWO-WAY ROADWAY
APPROACH LANE
- DRAWING 405-01-E(1)**
DRAWING 405-01-E(2) - FLAGGING OPERATIONS
MULTIPLE FLAGGERS
TWO-LANE TWO-WAY ROADWAYS
PRIMARY & SECONDARY ROUTES
WORK ACTIVITY AREA
INTERSECTIONS with
LOW SPEED
< / = 35 MPH
MULTILANE ROADWAYS
- DRAWING 405-01-F(1)**
DRAWING 405-01-F(2) - FLAGGING OPERATIONS
MULTIPLE FLAGGERS
TWO-LANE TWO-WAY ROADWAYS
PRIMARY & SECONDARY ROUTES
WORK ACTIVITY AREA
INTERSECTIONS with
INTERMEDIATE SPEED to HIGH SPEED
40 MPH - 60 MPH
MULTILANE ROADWAYS

- DRAWING 405-02** - FLAGGING OPERATIONS
SINGLE FLAGGER OPERATION
LOW VOLUME
LOW SPEED TO INTERMEDIATE SPEED
TWO-LANE TWO-WAY ROADWAYS
PRIMARY & SECONDARY ROUTES

SHOULDER CLOSURES

- DRAWING 515-01-A** - RIGHT SHOULDER CLOSURE
CASE I / CASE II
TWO-LANE TWO-WAY ROADWAYS
PRIMARY & SECONDARY ROUTES
- DRAWING 515-01-C** - RIGHT SHOULDER CLOSURE
LOW SPEED
< / = 35 MPH
PRIMARY & SECONDARY ROUTES
(MINOR ENCROACHMENT)

MOBILIZED SHOULDER OPERATIONS

- DRAWING 525-01** - MOBILIZED SHOULDER OPERATIONS
ROAD MACHINERY – MINOR ENCROACHMENT
PRIMARY & SECONDARY ROUTES
- DRAWING 525-02** - MOBILIZED SHOULDER OPERATIONS
PEDESTRIAN WORKERS – NO ENCROACHMENT
ROAD MACHINERY – MINOR ENCROACHMENT
PRIMARY & SECONDARY ROUTES
- DRAWING 525-03** - MOBILIZED SHOULDER OPERATIONS
ROAD MACHINERY – MAJOR ENCROACHMENT
PRIMARY & SECONDARY ROUTES

MOBILE OPERATIONS – INTERMITTENT

- DRAWING 535-01-A** - MOBILE OPERATIONS – INTERMITTENT
STOPPING SIGHT DISTANCE
VEHICLE TRAIN REQUIREMENTS
VERTICAL CURVE (HILL)
- DRAWING 535-01-B** - MOBILE OPERATIONS – INTERMITTENT
STOPPING SIGHT DISTANCE
VEHICLE TRAIN REQUIREMENTS
HORIZONTAL CURVE (CURVE)
- DRAWING 535-02-A** - MOBILE OPERATIONS – INTERMITTENT
LOW VOLUME
LOW SPEED
PRIMARY & SECONDARY ROUTES
- DRAWING 535-02-B** - MOBILE OPERATIONS – INTERMITTENT
LOW VOLUME
INTERMEDIATE SPEED TO HIGH SPEED
PRIMARY & SECONDARY ROUTES
- DRAWING 535-03-A** - MOBILE OPERATIONS – INTERMITTENT
INTERMEDIATE VOLUME
LOW SPEED
PRIMARY & SECONDARY ROUTES

- DRAWING 535-03-B** - MOBILE OPERATIONS – INTERMITTENT
INTERMEDIATE VOLUME
INTERMEDIATE SPEED TO HIGH SPEED
PRIMARY & SECONDARY ROUTES
- DRAWING 535-04-A** - MOBILE OPERATIONS – INTERMITTENT
HIGH VOLUME
LOW SPEED
PRIMARY & SECONDARY ROUTES
- DRAWING 535-04-B** - MOBILE OPERATIONS – INTERMITTENT
HIGH VOLUME
LOW SPEED
INTERIOR TRAVEL LANE OPERATIONS
PRIMARY & SECONDARY ROUTES
- DRAWING 535-04-C** - MOBILE OPERATIONS – INTERMITTENT
HIGH VOLUME
INTERMEDIATE SPEED TO HIGH SPEED
PRIMARY & SECONDARY ROUTES

MULTILANE SECONDARY AND PRIMARY ROADWAYS

Utilize intermittent mobile operations for these work activities under the following conditions:

Condition 1 - The maximum time duration of a stop is 15 minutes if the work vehicle and/or the shadow vehicle encroach upon a travel lane more than 2 feet.

Condition 2 - The maximum time duration of a stop is 30 minutes if the work vehicle and/or the shadow vehicle encroach upon a travel lane 2 feet or less.

During intermittent mobile operations, utilize a shadow vehicle when the stopping sight distance interval between the work vehicle or road machinery and an approaching motorist is unavailable based upon the posted regulatory speed limit of the work location.

Mobilized shoulder operations may be used for work activities requiring only one (1) single equipment unit that progress along the roadway at a slow pace and require road machinery operating on the shoulder to encroach upon the roadway.

On low speed roadways with speeds of 35 mph or less, shoulder closures designed for minor encroachment are acceptable for work activities conducted within 30 feet of the near edge of an adjacent travel lane that may require encroachment upon the roadway by personnel, tools, equipment, materials, vehicles, etc. to the extent that may require a reduction of the lane width of an adjacent travel lane to no less than 10 feet.

On low speed roadways with speeds of 35 mph or less, standard shoulder closures are required for work activities that require the presence of personnel, tools, equipment, materials, vehicles, etc. beyond 1 foot but within 30 feet of the near edge of an adjacent travel lane.

On low speed roadways, lane closures are required when encroachment of the work activities onto the roadway will reduce the lane width of the adjacent travel lane to less than 10 feet.

On intermediate to high speed roadways, standard shoulder closures are required for work activities that require the presence of personnel, tools, equipment, materials, vehicles, etc. beyond 1 foot but within 30 feet of the near edge of an adjacent travel lane.

On intermediate to high speed roadways, lane closures are required when the work activities require the presence of personnel, tools, equipment, materials, vehicles, etc. to encroach upon the roadway or to within 1 foot of the near edge of an adjacent travel lane.

Lane closures are required for work activities that cannot be conducted under the conditions required for intermittent mobile operations, mobilized shoulder operations, standard shoulder closures or shoulder closures with minor encroachment.

TYPICAL DRAWING APPLICATIONS

LANE CLOSURES

DRAWING 505-01	-	LANE CLOSURE LOW SPEED MULTILANE < / = 35 MPH PRIMARY & SECONDARY ROUTES
DRAWING 505-03-A	-	LANE CLOSURE INTERMEDIATE SPEED TO HIGH SPEED 40 MPH - 60 MPH MULTILANE PRIMARY & SECONDARY ROUTES

SHOULDER CLOSURES

- DRAWING 515-01-B** - RIGHT SHOULDER CLOSURE
CASE I / CASE II
MULTILANE
PRIMARY & SECONDARY ROUTES
- DRAWING 515-01-C** - RIGHT SHOULDER CLOSURE
LOW SPEED
< / = 35 MPH
PRIMARY & SECONDARY ROUTES
(MINOR ENCROACHMENT)
- DRAWING 515-01-D** - LEFT SHOULDER CLOSURE
LOW SPEED
< / = 35 MPH
MULTILANE DIVIDED HIGHWAY
w/ GRASSED EARTH MEDIAN
PRIMARY & SECONDARY ROUTES
(MINOR ENCROACHMENT)
- DRAWING 515-02** - LEFT SHOULDER CLOSURE
CASE I / CASE I
MULTILANE
PRIMARY & SECONDARY ROUTES
- DRAWING 515-03** - LEFT SHOULDER CLOSURE
CASE I / CASE II
MULTILANE
PRIMARY & SECONDARY ROUTES

MOBILIZED SHOULDER OPERATIONS

- DRAWING 525-01** - MOBILIZED SHOULDER OPERATIONS
ROAD MACHINERY – MINOR ENCROACHMENT
PRIMARY & SECONDARY ROUTES
- DRAWING 525-02** - MOBILIZED SHOULDER OPERATIONS
PEDESTRIAN WORKERS – NO ENCROACHMENT
ROAD MACHINERY – MINOR ENCROACHMENT
PRIMARY & SECONDARY ROUTES
- DRAWING 525-03** - MOBILIZED SHOULDER OPERATIONS
ROAD MACHINERY – MAJOR ENCROACHMENT
PRIMARY & SECONDARY ROUTES

MOBILE OPERATIONS – INTERMITTENT

- DRAWING 535-01-A** - MOBILE OPERATIONS – INTERMITTENT
STOPPING SIGHT DISTANCE
VEHICLE TRAIN REQUIREMENTS
VERTICAL CURVE (HILL)
- DRAWING 535-01-B** - MOBILE OPERATIONS – INTERMITTENT
STOPPING SIGHT DISTANCE
VEHICLE TRAIN REQUIREMENTS
HORIZONTAL CURVE (CURVE)
- DRAWING 535-03-A** - MOBILE OPERATIONS – INTERMITTENT
INTERMEDIATE VOLUME
LOW SPEED
PRIMARY & SECONDARY ROUTES

- DRAWING 535-03-B** - MOBILE OPERATIONS – INTERMITTENT
INTERMEDIATE VOLUME
INTERMEDIATE SPEED TO HIGH SPEED
PRIMARY & SECONDARY ROUTES
- DRAWING 535-04-A** - MOBILE OPERATIONS – INTERMITTENT
HIGH VOLUME
LOW SPEED
PRIMARY & SECONDARY ROUTES
- DRAWING 535-04-B** - MOBILE OPERATIONS – INTERMITTENT
HIGH VOLUME
LOW SPEED
INTERIOR TRAVEL LANE OPERATIONS
PRIMARY & SECONDARY ROUTES
- DRAWING 535-04-C** - MOBILE OPERATIONS – INTERMITTENT
HIGH VOLUME
INTERMEDIATE SPEED TO HIGH SPEED
PRIMARY & SECONDARY ROUTES

INTERSTATE ROADWAYS

Utilize intermittent mobile operations for these work activities under the following conditions:

Condition 1 - The maximum time duration of a stop is 5 minutes if the work vehicle and/or the shadow vehicle encroach upon an adjacent travel lane due to a shoulder area inadequate to accommodate a vehicle in its entirety due to the presence of a concrete median barrier wall or a bridge parapet wall.

Condition 2 - The maximum time duration of a stop is 30 minutes if the vehicles remain in the shoulder areas in their entirety with no encroachment upon an adjacent travel lane.

During intermittent mobile operations, utilize a shadow vehicle when the stopping sight distance interval between the work vehicle or road machinery and an approaching motorist is unavailable based upon the posted regulatory speed limit of the work location.

Mobilized shoulder operations may be used for work activities that progress along the roadway at a slow pace and require equipment, personnel, materials, or any vehicles to encroach upon the adjacent paved shoulder within the limits specified by the typical drawing applications for interstate mobilized shoulder operations.

Standard shoulder closures may be used for work activities that cannot be conducted under the conditions required for intermittent mobile operations or mobilized shoulder operations.

Lane closures are required for work activities that cannot be conducted under the conditions required for intermittent mobile operations, mobilized shoulder operations or standard shoulder closures.

(Brief periodic encroachments upon the adjacent travel lane for the equipment to relocate or bypass structures such as guardrail locations or bridge structures are acceptable.)

TYPICAL DRAWING APPLICATIONS

LANE CLOSURES

- DRAWING 510-01-A** - LANE CLOSURE
INTERSTATE ROUTES
- DRAWING 510-01-B** - LANE CLOSURE
EXIT / ENTRANCE RAMPS
INTERSTATE ROUTES

SHOULDER CLOSURES

- DRAWING 520-01** - RIGHT SHOULDER CLOSURE
CASE I / CASE II
INTERSTATE ROUTES
- DRAWING 520-02** - LEFT SHOULDER CLOSURE
CASE I / CASE I
NARROW MEDIAN
INTERSTATE ROUTES
- DRAWING 520-03** - LEFT SHOULDER CLOSURE
CASE I / CASE I
WIDE MEDIAN
INTERSTATE ROUTES
- DRAWING 520-04** - LEFT SHOULDER CLOSURE
CASE I / CASE II
WIDE MEDIAN
INTERSTATE ROUTES
- DRAWING 520-05** - LEFT SHOULDER CLOSURE
CASE II / CASE II
WIDE MEDIAN
INTERSTATE ROUTES

MOBILIZED SHOULDER OPERATIONS

- DRAWING 530-01** - MOBILIZED SHOULDER OPERATIONS
ROAD MACHINERY – MAJOR ENCROACHMENT
INTERSTATE ROUTES
- DRAWING 530-02** - MOBILIZED SHOULDER OPERATIONS
PEDESTRIAN WORKERS – MINOR ENCROACHMENT
UPON PAVED SHOULDER
INTERSTATE ROUTES
- DRAWING 530-03** - MOBILIZED SHOULDER OPERATIONS
PEDESTRIAN WORKERS – MAJOR ENCROACHMENT
UPON PAVED SHOULDER
ROAD MACHINERY – MAJOR ENCROACHMENT
UPON TRAVEL LANE
INTERSTATE ROUTES

MOBILE OPERATIONS – INTERMITTENT

- DRAWING 535-01-A** - MOBILE OPERATIONS – INTERMITTENT
STOPPING SIGHT DISTANCE
VEHICLE TRAIN REQUIREMENTS
VERTICAL CURVE (HILL)
- DRAWING 535-01-B** - MOBILE OPERATIONS – INTERMITTENT
STOPPING SIGHT DISTANCE
VEHICLE TRAIN REQUIREMENTS
HORIZONTAL CURVE (CURVE)
- DRAWING 535-04-D(1)** - MOBILE OPERATIONS – INTERMITTENT
HIGH VOLUME
HIGH SPEED
INTERSTATE ROUTES
- DRAWING 535-04-E** - MOBILE OPERATIONS – INTERMITTENT
HIGH VOLUME
HIGH SPEED
INTERIOR TRAVEL LANE OPERATIONS
INTERSTATE ROUTES

PERFORMANCE ACTIVITY 407

LITTER CONTROL

WORK DESCRIPTION 1
WORK DESCRIPTION 2
WORK DESCRIPTION 3

Litter
Dead Animals
Litter Bag Pickup

407 LITTER CONTROL

ACTIVITY DESCRIPTION

Clear the roadways and roadsides of litter and animal carcasses.

WORK DESCRIPTION 1 Litter

TRAFFIC CONTROL

TWO-LANE TWO-WAY ROADWAYS

Utilize intermittent mobile operations for these work activities under the following conditions:

Condition 1 - The maximum time duration of a stop is 15 minutes if the work vehicle and/or the shadow vehicle encroach upon a travel lane more than 2 feet.

Condition 2 - The maximum time duration of a stop is 30 minutes if the work vehicle and/or the shadow vehicle encroach upon a travel lane 2 feet or less.

During intermittent mobile operations, utilize a shadow vehicle when the stopping sight distance interval between the work vehicle or road machinery and an approaching motorist is unavailable based upon the posted regulatory speed limit of the work location.

TYPICAL DRAWING APPLICATIONS

MOBILE OPERATIONS – INTERMITTENT

DRAWING 535-01-A	-	MOBILE OPERATIONS – INTERMITTENT STOPPING SIGHT DISTANCE VEHICLE TRAIN REQUIREMENTS VERTICAL CURVE (HILL)
DRAWING 535-01-B	-	MOBILE OPERATIONS – INTERMITTENT STOPPING SIGHT DISTANCE VEHICLE TRAIN REQUIREMENTS HORIZONTAL CURVE (CURVE)
DRAWING 535-02-A	-	MOBILE OPERATIONS – INTERMITTENT LOW VOLUME LOW SPEED
DRAWING 535-02-B	-	PRIMARY & SECONDARY ROUTES MOBILE OPERATIONS – INTERMITTENT LOW VOLUME INTERMEDIATE SPEED TO HIGH SPEED PRIMARY & SECONDARY ROUTES
DRAWING 535-03-A	-	MOBILE OPERATIONS – INTERMITTENT INTERMEDIATE VOLUME LOW SPEED PRIMARY & SECONDARY ROUTES
DRAWING 535-03-B	-	MOBILE OPERATIONS – INTERMITTENT INTERMEDIATE VOLUME INTERMEDIATE SPEED TO HIGH SPEED PRIMARY & SECONDARY ROUTES
DRAWING 535-04-A	-	MOBILE OPERATIONS – INTERMITTENT HIGH VOLUME LOW SPEED PRIMARY & SECONDARY ROUTES

- DRAWING 535-04-B** - MOBILE OPERATIONS – INTERMITTENT
HIGH VOLUME
LOW SPEED
INTERIOR TRAVEL LANE OPERATIONS
PRIMARY & SECONDARY ROUTES
- DRAWING 535-04-C** - MOBILE OPERATIONS – INTERMITTENT
HIGH VOLUME
INTERMEDIATE SPEED TO HIGH SPEED
PRIMARY & SECONDARY ROUTES

MULTILANE SECONDARY AND PRIMARY ROADWAYS

Utilize intermittent mobile operations for these work activities under the following conditions:

Condition 1 - The maximum time duration of a stop is 15 minutes if the work vehicle and/or the shadow vehicle encroach upon a travel lane more than 2 feet.

Condition 2 - The maximum time duration of a stop is 30 minutes if the work vehicle and/or the shadow vehicle encroach upon a travel lane 2 feet or less.

During intermittent mobile operations, utilize a shadow vehicle when the stopping sight distance interval between the work vehicle or road machinery and an approaching motorist is unavailable based upon the posted regulatory speed limit of the work location.

TYPICAL DRAWING APPLICATIONS

MOBILE OPERATIONS – INTERMITTENT

- DRAWING 535-01-A** - MOBILE OPERATIONS – INTERMITTENT
STOPPING SIGHT DISTANCE
VEHICLE TRAIN REQUIREMENTS
VERTICAL CURVE (HILL)
- DRAWING 535-01-B** - MOBILE OPERATIONS – INTERMITTENT
STOPPING SIGHT DISTANCE
VEHICLE TRAIN REQUIREMENTS
HORIZONTAL CURVE (CURVE)
- DRAWING 535-03-A** - MOBILE OPERATIONS – INTERMITTENT
INTERMEDIATE VOLUME
LOW SPEED
PRIMARY & SECONDARY ROUTES
- DRAWING 535-03-B** - MOBILE OPERATIONS – INTERMITTENT
INTERMEDIATE VOLUME
INTERMEDIATE SPEED TO HIGH SPEED
PRIMARY & SECONDARY ROUTES
- DRAWING 535-04-A** - MOBILE OPERATIONS – INTERMITTENT
HIGH VOLUME
LOW SPEED
PRIMARY & SECONDARY ROUTES
- DRAWING 535-04-B** - MOBILE OPERATIONS – INTERMITTENT
HIGH VOLUME
LOW SPEED
INTERIOR TRAVEL LANE OPERATIONS
PRIMARY & SECONDARY ROUTES
- DRAWING 535-04-C** - MOBILE OPERATIONS – INTERMITTENT
HIGH VOLUME
INTERMEDIATE SPEED TO HIGH SPEED
PRIMARY & SECONDARY ROUTES

INTERSTATE ROADWAYS

Utilize intermittent mobile operations for these work activities under the following conditions:

Condition 1 - The maximum time duration of a stop is 5 minutes if the work vehicle and/or the shadow vehicle encroach upon an adjacent travel lane due to a shoulder area inadequate to accommodate a vehicle in its entirety due to the presence of a concrete median barrier wall or a bridge parapet wall.

Condition 2 - The maximum time duration of a stop is 30 minutes if the vehicles remain in the shoulder areas in their entirety with no encroachment upon an adjacent travel lane.

During intermittent mobile operations, utilize a shadow vehicle when the stopping sight distance interval between the work vehicle or road machinery and an approaching motorist is unavailable based upon the posted regulatory speed limit of the work location.

Traffic control set-ups for mobilized shoulder operations may be utilized for work activities that cannot be conducted under the conditions required for intermittent mobile operations.

Standard shoulder closures may be utilized for work activities that cannot be conducted under the conditions required for intermittent mobile operations or mobilized shoulder operations.

(Brief periodic encroachments upon the adjacent travel lane for the equipment to relocate or bypass structures such as guardrail locations or bridge structures are acceptable.)

TYPICAL DRAWING APPLICATIONS

SHOULDER CLOSURES

- | | | |
|-----------------------|---|--|
| DRAWING 520-01 | - | RIGHT SHOULDER CLOSURE
CASE I / CASE II
INTERSTATE ROUTES |
| DRAWING 520-02 | - | LEFT SHOULDER CLOSURE
CASE I / CASE I
NARROW MEDIAN
INTERSTATE ROUTES |
| DRAWING 520-03 | - | LEFT SHOULDER CLOSURE
CASE I / CASE I
WIDE MEDIAN
INTERSTATE ROUTES |
| DRAWING 520-04 | - | LEFT SHOULDER CLOSURE
CASE I / CASE II
WIDE MEDIAN
INTERSTATE ROUTES |
| DRAWING 520-05 | - | LEFT SHOULDER CLOSURE
CASE II / CASE II
WIDE MEDIAN
INTERSTATE ROUTES |

MOBILIZED SHOULDER OPERATIONS

- | | | |
|-----------------------|---|--|
| DRAWING 530-02 | - | MOBILIZED SHOULDER OPERATIONS
PEDESTRIAN WORKERS – MINOR ENCROACHMENT
UPON PAVED SHOULDER
INTERSTATE ROUTES |
|-----------------------|---|--|

MOBILE OPERATIONS – INTERMITTENT

- DRAWING 535-01-A** - MOBILE OPERATIONS – INTERMITTENT
STOPPING SIGHT DISTANCE
VEHICLE TRAIN REQUIREMENTS
VERTICAL CURVE (HILL)
- DRAWING 535-01-B** - MOBILE OPERATIONS – INTERMITTENT
STOPPING SIGHT DISTANCE
VEHICLE TRAIN REQUIREMENTS
HORIZONTAL CURVE (CURVE)
- DRAWING 535-04-D(1)** - MOBILE OPERATIONS – INTERMITTENT
HIGH VOLUME
HIGH SPEED
INTERSTATE ROUTES
- DRAWING 535-04-E** - MOBILE OPERATIONS – INTERMITTENT
HIGH VOLUME
HIGH SPEED
INTERIOR TRAVEL LANE OPERATIONS
INTERSTATE ROUTES

WORK DESCRIPTION 2 Dead Animals

TRAFFIC CONTROL

TWO-LANE TWO-WAY ROADWAYS

Utilize intermittent mobile operations for these work activities under the following conditions:

Condition 1 - The maximum time duration of a stop is 15 minutes if the work vehicle and/or the shadow vehicle encroach upon a travel lane more than 2 feet.

Condition 2 - The maximum time duration of a stop is 30 minutes if the work vehicle and/or the shadow vehicle encroach upon a travel lane 2 feet or less.

During intermittent mobile operations, utilize a shadow vehicle when the stopping sight distance interval between the work vehicle or road machinery and an approaching motorist is unavailable based upon the posted regulatory speed limit of the work location.

TYPICAL DRAWING APPLICATIONS

MOBILE OPERATIONS – INTERMITTENT

- DRAWING 535-01-A** - MOBILE OPERATIONS – INTERMITTENT
STOPPING SIGHT DISTANCE
VEHICLE TRAIN REQUIREMENTS
VERTICAL CURVE (HILL)
- DRAWING 535-01-B** - MOBILE OPERATIONS – INTERMITTENT
STOPPING SIGHT DISTANCE
VEHICLE TRAIN REQUIREMENTS
HORIZONTAL CURVE (CURVE)
- DRAWING 535-02-A** - MOBILE OPERATIONS – INTERMITTENT
LOW VOLUME
LOW SPEED
- DRAWING 535-02-B** - PRIMARY & SECONDARY ROUTES
MOBILE OPERATIONS – INTERMITTENT
LOW VOLUME
INTERMEDIATE SPEED TO HIGH SPEED
PRIMARY & SECONDARY ROUTES

- DRAWING 535-03-A** - MOBILE OPERATIONS – INTERMITTENT
INTERMEDIATE VOLUME
LOW SPEED
PRIMARY & SECONDARY ROUTES
- DRAWING 535-03-B** - MOBILE OPERATIONS – INTERMITTENT
INTERMEDIATE VOLUME
INTERMEDIATE SPEED TO HIGH SPEED
PRIMARY & SECONDARY ROUTES
- DRAWING 535-04-A** - MOBILE OPERATIONS – INTERMITTENT
HIGH VOLUME
LOW SPEED
PRIMARY & SECONDARY ROUTES
- DRAWING 535-04-B** - MOBILE OPERATIONS – INTERMITTENT
HIGH VOLUME
LOW SPEED
INTERIOR TRAVEL LANE OPERATIONS
PRIMARY & SECONDARY ROUTES
- DRAWING 535-04-C** - MOBILE OPERATIONS – INTERMITTENT
HIGH VOLUME
INTERMEDIATE SPEED TO HIGH SPEED
PRIMARY & SECONDARY ROUTES

MULTILANE SECONDARY AND PRIMARY ROADWAYS

Utilize intermittent mobile operations for these work activities under the following conditions:

Condition 1 - The maximum time duration of a stop is 15 minutes if the work vehicle and/or the shadow vehicle encroach upon a travel lane more than 2 feet.

Condition 2 - The maximum time duration of a stop is 30 minutes if the work vehicle and/or the shadow vehicle encroach upon a travel lane 2 feet or less.

During intermittent mobile operations, utilize a shadow vehicle when the stopping sight distance interval between the work vehicle or road machinery and an approaching motorist is unavailable based upon the posted regulatory speed limit of the work location.

TYPICAL DRAWING APPLICATIONS

MOBILE OPERATIONS – INTERMITTENT

- DRAWING 535-01-A** - MOBILE OPERATIONS – INTERMITTENT
STOPPING SIGHT DISTANCE
VEHICLE TRAIN REQUIREMENTS
VERTICAL CURVE (HILL)
- DRAWING 535-01-B** - MOBILE OPERATIONS – INTERMITTENT
STOPPING SIGHT DISTANCE
VEHICLE TRAIN REQUIREMENTS
HORIZONTAL CURVE (CURVE)
- DRAWING 535-03-A** - MOBILE OPERATIONS – INTERMITTENT
INTERMEDIATE VOLUME
LOW SPEED
PRIMARY & SECONDARY ROUTES
- DRAWING 535-03-B** - MOBILE OPERATIONS – INTERMITTENT
INTERMEDIATE VOLUME
INTERMEDIATE SPEED TO HIGH SPEED
PRIMARY & SECONDARY ROUTES

- DRAWING 535-04-A** - MOBILE OPERATIONS – INTERMITTENT
HIGH VOLUME
LOW SPEED
PRIMARY & SECONDARY ROUTES
- DRAWING 535-04-B** - MOBILE OPERATIONS – INTERMITTENT
HIGH VOLUME
LOW SPEED
INTERIOR TRAVEL LANE OPERATIONS
PRIMARY & SECONDARY ROUTES
- DRAWING 535-04-C** - MOBILE OPERATIONS – INTERMITTENT
HIGH VOLUME
INTERMEDIATE SPEED TO HIGH SPEED
PRIMARY & SECONDARY ROUTES

INTERSTATE ROADWAYS

Utilize intermittent mobile operations for these work activities under the following conditions:

Condition 1 - The maximum time duration of a stop is 5 minutes if the work vehicle and/or the shadow vehicle encroach upon an adjacent travel lane due to a shoulder area inadequate to accommodate a vehicle in its entirety due to the presence of a concrete median barrier wall or a bridge parapet wall.

Condition 2 - The maximum time duration of a stop is 30 minutes if the vehicles remain in the shoulder areas in their entirety with no encroachment upon an adjacent travel lane.

During intermittent mobile operations, utilize a shadow vehicle when the stopping sight distance interval between the work vehicle or road machinery and an approaching motorist is unavailable based upon the posted regulatory speed limit of the work location.

TYPICAL DRAWING APPLICATIONS

MOBILE OPERATIONS – INTERMITTENT

- DRAWING 535-01-A** - MOBILE OPERATIONS – INTERMITTENT
STOPPING SIGHT DISTANCE
VEHICLE TRAIN REQUIREMENTS
VERTICAL CURVE (HILL)
- DRAWING 535-01-B** - MOBILE OPERATIONS – INTERMITTENT
STOPPING SIGHT DISTANCE
VEHICLE TRAIN REQUIREMENTS
HORIZONTAL CURVE (CURVE)
- DRAWING 535-04-D(1)** - MOBILE OPERATIONS – INTERMITTENT
HIGH VOLUME
HIGH SPEED
INTERSTATE ROUTES
- DRAWING 535-04-E** - MOBILE OPERATIONS – INTERMITTENT
HIGH VOLUME
HIGH SPEED
INTERIOR TRAVEL LANE OPERATIONS
INTERSTATE ROUTES

WORK DESCRIPTION 3 Litter Bag Pickup

TRAFFIC CONTROL

TWO-LANE TWO-WAY ROADWAYS

Utilize intermittent mobile operations for these work activities under the following conditions:

Condition 1 - The maximum time duration of a stop is 15 minutes if the work vehicle and/or the shadow vehicle encroach upon a travel lane more than 2 feet.

Condition 2 - The maximum time duration of a stop is 30 minutes if the work vehicle and/or the shadow vehicle encroach upon a travel lane 2 feet or less.

During intermittent mobile operations, utilize a shadow vehicle when the stopping sight distance interval between the work vehicle or road machinery and an approaching motorist is unavailable based upon the posted regulatory speed limit of the work location.

TYPICAL DRAWING APPLICATIONS

MOBILE OPERATIONS – INTERMITTENT

DRAWING 535-01-A	-	MOBILE OPERATIONS – INTERMITTENT STOPPING SIGHT DISTANCE VEHICLE TRAIN REQUIREMENTS VERTICAL CURVE (HILL)
DRAWING 535-01-B	-	MOBILE OPERATIONS – INTERMITTENT STOPPING SIGHT DISTANCE VEHICLE TRAIN REQUIREMENTS HORIZONTAL CURVE (CURVE)
DRAWING 535-02-A	-	MOBILE OPERATIONS – INTERMITTENT LOW VOLUME LOW SPEED
DRAWING 535-02-B	-	PRIMARY & SECONDARY ROUTES MOBILE OPERATIONS – INTERMITTENT LOW VOLUME INTERMEDIATE SPEED TO HIGH SPEED PRIMARY & SECONDARY ROUTES
DRAWING 535-03-A	-	MOBILE OPERATIONS – INTERMITTENT INTERMEDIATE VOLUME LOW SPEED PRIMARY & SECONDARY ROUTES
DRAWING 535-03-B	-	MOBILE OPERATIONS – INTERMITTENT INTERMEDIATE VOLUME INTERMEDIATE SPEED TO HIGH SPEED PRIMARY & SECONDARY ROUTES
DRAWING 535-04-A	-	MOBILE OPERATIONS – INTERMITTENT HIGH VOLUME LOW SPEED PRIMARY & SECONDARY ROUTES
DRAWING 535-04-B	-	MOBILE OPERATIONS – INTERMITTENT HIGH VOLUME LOW SPEED INTERIOR TRAVEL LANE OPERATIONS PRIMARY & SECONDARY ROUTES

DRAWING 535-04-C - MOBILE OPERATIONS – INTERMITTENT
HIGH VOLUME
INTERMEDIATE SPEED TO HIGH SPEED
PRIMARY & SECONDARY ROUTES

MULTILANE SECONDARY AND PRIMARY ROADWAYS

Utilize intermittent mobile operations for these work activities under the following conditions:

Condition 1 - The maximum time duration of a stop is 15 minutes if the work vehicle and/or the shadow vehicle encroach upon a travel lane more than 2 feet.

Condition 2 - The maximum time duration of a stop is 30 minutes if the work vehicle and/or the shadow vehicle encroach upon a travel lane 2 feet or less.

During intermittent mobile operations, utilize a shadow vehicle when the stopping sight distance interval between the work vehicle or road machinery and an approaching motorist is unavailable based upon the posted regulatory speed limit of the work location.

TYPICAL DRAWING APPLICATIONS

MOBILE OPERATIONS – INTERMITTENT

DRAWING 535-01-A - MOBILE OPERATIONS – INTERMITTENT
STOPPING SIGHT DISTANCE
VEHICLE TRAIN REQUIREMENTS
VERTICAL CURVE (HILL)

DRAWING 535-01-B - MOBILE OPERATIONS – INTERMITTENT
STOPPING SIGHT DISTANCE
VEHICLE TRAIN REQUIREMENTS
HORIZONTAL CURVE (CURVE)

DRAWING 535-03-A - MOBILE OPERATIONS – INTERMITTENT
INTERMEDIATE VOLUME
LOW SPEED
PRIMARY & SECONDARY ROUTES

DRAWING 535-03-B - MOBILE OPERATIONS – INTERMITTENT
INTERMEDIATE VOLUME
INTERMEDIATE SPEED TO HIGH SPEED
PRIMARY & SECONDARY ROUTES

DRAWING 535-04-A - MOBILE OPERATIONS – INTERMITTENT
HIGH VOLUME
LOW SPEED
PRIMARY & SECONDARY ROUTES

DRAWING 535-04-B - MOBILE OPERATIONS – INTERMITTENT
HIGH VOLUME
LOW SPEED
INTERIOR TRAVEL LANE OPERATIONS
PRIMARY & SECONDARY ROUTES

DRAWING 535-04-C - MOBILE OPERATIONS – INTERMITTENT
HIGH VOLUME
INTERMEDIATE SPEED TO HIGH SPEED
PRIMARY & SECONDARY ROUTES

PERFORMANCE ACTIVITY 408

TREE REMOVAL

WORK DESCRIPTION 1
WORK DESCRIPTION 2

Fallen Tree
Standing Tree

408 TREE REMOVAL

ACTIVITY DESCRIPTION

Cut and remove tree as necessary.

WORK DESCRIPTION 1 Fallen Tree

WORK DESCRIPTION 2 Standing Tree

DURING EMERGENCY SITUATIONS, COMPLETE CLOSURE OF THE ROADWAY MAY BE NECESSARY.

DURING EMERGENCY SITUATIONS, HOURLY AND DISTANCE REQUIREMENTS FOR FLAGGING OPERATIONS, LANE CLOSURES AND SHOULDER CLOSURES MAY BE DISREGARDED PROVIDED THE WORK CREW INCLUDES NO LESS THAN TWO PERSONS AND A WORK VEHICLE FULLY EQUIPPED WITH THE REQUIRED HIGH INTENSITY ROTATING, FLASHING, OSCILLATING OR STROBE AUXILIARY WARNING LIGHTS.

TRAFFIC CONTROL

TWO-LANE TWO-WAY ROADWAYS

Flagging operations are required for planned work activities that require equipment, personnel, materials, or any vehicles to encroach upon a travel lane or within 1 foot of a travel lane. When the work may be performed without the necessity for equipment, personnel, materials, or vehicles to encroach within 1 foot of an adjacent travel or without creating a hazard to passing motorists, utilize right shoulder closures.

TYPICAL DRAWING APPLICATIONS

FLAGGING OPERATIONS

DRAWING 405-01-A	-	FLAGGING OPERATIONS MULTIPLE FLAGGERS TWO-LANE TWO-WAY ROADWAYS PRIMARY & SECONDARY ROUTES
DRAWING 405-01-B(1)	-	FLAGGING OPERATIONS MULTIPLE FLAGGERS TWO-LANE TWO-WAY ROADWAYS PRIMARY & SECONDARY ROUTES STOP SIGN CONTROLLED SIDE ROADS
DRAWING 405-01-B(2)	-	FLAGGING OPERATIONS MULTIPLE FLAGGERS TWO-LANE TWO-WAY ROADWAYS PRIMARY & SECONDARY ROUTES 4-WAY STOP CONTROLLED INTERSECTION
DRAWING 405-01-C(1)	-	FLAGGING OPERATIONS MULTIPLE FLAGGERS TWO-LANE TWO-WAY ROADWAYS PRIMARY & SECONDARY ROUTES TRAFFIC SIGNAL CONTROLLED INTERSECTION LAW ENFORCEMENT OFFICER(S)
DRAWING 405-01-C(2)	-	FLAGGING OPERATIONS MULTIPLE FLAGGERS TWO-LANE TWO-WAY ROADWAYS PRIMARY & SECONDARY ROUTES TRAFFIC SIGNAL CONTROLLED INTERSECTION FLAGGERS

- DRAWING 405-01-D(1)** - FLAGGING OPERATIONS
 MULTIPLE FLAGGERS
 TWO-LANE TWO-WAY ROADWAYS
 PRIMARY & SECONDARY ROUTES
 WORK ACTIVITY AREA
 BEGINNING at an
 INTERSECTION with a
 TWO-LANE TWO-WAY ROADWAY
 DEPARTURE LANE
- DRAWING 405-01-D(2)** - FLAGGING OPERATIONS
 MULTIPLE FLAGGERS
 TWO-LANE TWO-WAY ROADWAYS
 PRIMARY & SECONDARY ROUTES
 WORK ACTIVITY AREA
 TERMINATING at an
 INTERSECTION with a
 TWO-LANE TWO-WAY ROADWAY
 APPROACH LANE
- DRAWING 405-01-E(1)**
DRAWING 405-01-E(2) - FLAGGING OPERATIONS
 MULTIPLE FLAGGERS
 TWO-LANE TWO-WAY ROADWAYS
 PRIMARY & SECONDARY ROUTES
 WORK ACTIVITY AREA
 INTERSECTIONS with
 LOW SPEED
 < / = 35 MPH
 MULTILANE ROADWAYS
- DRAWING 405-01-F(1)**
DRAWING 405-01-F(2) - FLAGGING OPERATIONS
 MULTIPLE FLAGGERS
 TWO-LANE TWO-WAY ROADWAYS
 PRIMARY & SECONDARY ROUTES
 WORK ACTIVITY AREA
 INTERSECTIONS with
 INTERMEDIATE SPEED to HIGH SPEED
 40 MPH - 60 MPH
 MULTILANE ROADWAYS
- DRAWING 405-02** - FLAGGING OPERATIONS
 SINGLE FLAGGER OPERATION
 LOW VOLUME
 LOW SPEED TO INTERMEDIATE SPEED
 TWO-LANE TWO-WAY ROADWAYS
 PRIMARY & SECONDARY ROUTES

SHOULDER CLOSURES

- DRAWING 515-01-A** - RIGHT SHOULDER CLOSURE
 CASE I / CASE II
 TWO-LANE TWO-WAY ROADWAYS
 PRIMARY & SECONDARY ROUTES

MULTILANE SECONDARY AND PRIMARY ROADWAYS

Lane closures are required for planned work activities that require equipment, personnel, materials, or any vehicles to encroach upon a travel lane or within 1 foot of a travel lane. When the work may be performed without the necessity for equipment, personnel, materials, or vehicles to encroach within 1 foot of an adjacent travel or without creating a hazard to passing motorists, utilize shoulder closures.

TYPICAL DRAWING APPLICATIONS

LANE CLOSURES

- | | | |
|-------------------------|---|--|
| DRAWING 505-01 | - | LANE CLOSURE
LOW SPEED MULTILANE
</= 35 MPH
PRIMARY & SECONDARY ROUTES |
| DRAWING 505-03-A | - | LANE CLOSURE
INTERMEDIATE SPEED TO HIGH SPEED
40 MPH - 60 MPH
MULTILANE
PRIMARY & SECONDARY ROUTES |

SHOULDER CLOSURES

- | | | |
|-------------------------|---|---|
| DRAWING 515-01-B | - | RIGHT SHOULDER CLOSURE
CASE I / CASE II
MULTILANE
PRIMARY & SECONDARY ROUTES |
| DRAWING 515-02 | - | LEFT SHOULDER CLOSURE
CASE I / CASE I
MULTILANE
PRIMARY & SECONDARY ROUTES |
| DRAWING 515-03 | - | LEFT SHOULDER CLOSURE
CASE I / CASE II
MULTILANE
PRIMARY & SECONDARY ROUTES |

INTERSTATE ROADWAYS

Utilize intermittent mobile operations for these work activities under the following conditions:

Condition 2 - The maximum time duration of a stop is 30 minutes if the vehicles remain in the shoulder areas in their entirety with no encroachment upon an adjacent travel lane.

During intermittent mobile operations, utilize a shadow vehicle when the stopping sight distance interval between the work vehicle or road machinery and an approaching motorist is unavailable based upon the posted regulatory speed limit of the work location.

Standard shoulder closures may be used for work activities that cannot be conducted under the conditions required for intermittent mobile operations.

Lane closures are required for planned work activities that require equipment, personnel, materials, or any vehicles to encroach upon a travel lane or within 10 feet of a travel lane. When the work may be performed without the necessity for equipment, personnel, materials, or vehicles to encroach within 10 feet of an adjacent travel or without creating a hazard to passing motorists, utilize shoulder closures.

Lane closures are required for planned work activities that cannot be conducted under the conditions required for intermittent mobile operations or standard shoulder closures.

TYPICAL DRAWING APPLICATIONS

LANE CLOSURES

- DRAWING 510-01-A - LANE CLOSURE
INTERSTATE ROUTES
- DRAWING 510-01-B - LANE CLOSURE
EXIT / ENTRANCE RAMP
INTERSTATE ROUTES

SHOULDER CLOSURES

- DRAWING 520-01 - RIGHT SHOULDER CLOSURE
CASE I / CASE II
INTERSTATE ROUTES
- DRAWING 520-02 - LEFT SHOULDER CLOSURE
CASE I / CASE I
NARROW MEDIAN
INTERSTATE ROUTES
- DRAWING 520-03 - LEFT SHOULDER CLOSURE
CASE I / CASE I
WIDE MEDIAN
INTERSTATE ROUTES
- DRAWING 520-04 - LEFT SHOULDER CLOSURE
CASE I / CASE II
WIDE MEDIAN
INTERSTATE ROUTES
- DRAWING 520-05 - LEFT SHOULDER CLOSURE
CASE II / CASE II
WIDE MEDIAN
INTERSTATE ROUTES

MOBILE OPERATIONS – INTERMITTENT

- DRAWING 535-01-A - MOBILE OPERATIONS – INTERMITTENT
STOPPING SIGHT DISTANCE
VEHICLE TRAIN REQUIREMENTS
VERTICAL CURVE (HILL)
- DRAWING 535-01-B - MOBILE OPERATIONS – INTERMITTENT
STOPPING SIGHT DISTANCE
VEHICLE TRAIN REQUIREMENTS
HORIZONTAL CURVE (CURVE)
- DRAWING 535-04-D(1) - MOBILE OPERATIONS – INTERMITTENT
HIGH VOLUME
HIGH SPEED
INTERSTATE ROUTES
- DRAWING 535-04-E - MOBILE OPERATIONS – INTERMITTENT
HIGH VOLUME
HIGH SPEED
INTERIOR TRAVEL LANE OPERATIONS
INTERSTATE ROUTES

PERFORMANCE ACTIVITY 409

DEBRIS REMOVAL

WORK DESCRIPTION 1	Vegetation
WORK DESCRIPTION 2	Construction / Demolition
WORK DESCRIPTION 3	Personal Property / Household Items
WORK DESCRIPTION 4	White Goods
WORK DESCRIPTION 5	Soil, Mud, Sand
WORK DESCRIPTION 6	Vehicles / Vessels
WORK DESCRIPTION 7	Hazardous Waste

409 DEBRIS REMOVAL

ACTIVITY DESCRIPTION

Collection and disposal of debris deposited on the right-of-way during storm events.

WORK DESCRIPTION 1 Vegetation
WORK DESCRIPTION 2 Construction / Demolition
WORK DESCRIPTION 3 Personal Property / Household Items
WORK DESCRIPTION 4 White Goods
WORK DESCRIPTION 5 Soil, Mud, Sand
WORK DESCRIPTION 6 Vehicles / Vessels

DURING EMERGENCY SITUATIONS, COMPLETE CLOSURE OF THE ROADWAY MAY BE NECESSARY.

DURING EMERGENCY SITUATIONS, HOURLY AND DISTANCE REQUIREMENTS FOR FLAGGING OPERATIONS, LANE CLOSURES AND SHOULDER CLOSURES MAY BE DISREGARDED PROVIDED THE WORK CREW INCLUDES NO LESS THAN TWO PERSONS AND A WORK VEHICLE FULLY EQUIPPED WITH THE REQUIRED HIGH INTENSITY ROTATING, FLASHING, OSCILLATING OR STROBE AUXILIARY WARNING LIGHTS.

TRAFFIC CONTROL

TWO-LANE TWO-WAY ROADWAYS

Flagging operations should be utilized for work activities that require equipment, personnel, materials, or any vehicles to encroach upon a travel lane or within 1 foot of a travel lane. When the work may be performed without the necessity for equipment, personnel, materials, or vehicles to encroach within 1 foot of an adjacent travel or without creating a hazard to passing motorists, utilize right shoulder closures.

TYPICAL DRAWING APPLICATIONS

FLAGGING OPERATIONS

DRAWING 405-01-A	-	FLAGGING OPERATIONS MULTIPLE FLAGGERS TWO-LANE TWO-WAY ROADWAYS PRIMARY & SECONDARY ROUTES
DRAWING 405-01-B(1)	-	FLAGGING OPERATIONS MULTIPLE FLAGGERS TWO-LANE TWO-WAY ROADWAYS PRIMARY & SECONDARY ROUTES STOP SIGN CONTROLLED SIDE ROADS
DRAWING 405-01-B(2)	-	FLAGGING OPERATIONS MULTIPLE FLAGGERS TWO-LANE TWO-WAY ROADWAYS PRIMARY & SECONDARY ROUTES 4-WAY STOP CONTROLLED INTERSECTION
DRAWING 405-01-C(1)	-	FLAGGING OPERATIONS MULTIPLE FLAGGERS TWO-LANE TWO-WAY ROADWAYS PRIMARY & SECONDARY ROUTES TRAFFIC SIGNAL CONTROLLED INTERSECTION LAW ENFORCEMENT OFFICER(S)

DRAWING 405-01-C(2) - FLAGGING OPERATIONS
MULTIPLE FLAGGERS
TWO-LANE TWO-WAY ROADWAYS
PRIMARY & SECONDARY ROUTES
TRAFFIC SIGNAL CONTROLLED INTERSECTION
FLAGGERS

DRAWING 405-01-D(1) - FLAGGING OPERATIONS
MULTIPLE FLAGGERS
TWO-LANE TWO-WAY ROADWAYS
PRIMARY & SECONDARY ROUTES
WORK ACTIVITY AREA
BEGINNING at an
INTERSECTION with a
TWO-LANE TWO-WAY ROADWAY
DEPARTURE LANE

DRAWING 405-01-D(2) - FLAGGING OPERATIONS
MULTIPLE FLAGGERS
TWO-LANE TWO-WAY ROADWAYS
PRIMARY & SECONDARY ROUTES
WORK ACTIVITY AREA
TERMINATING at an
INTERSECTION with a
TWO-LANE TWO-WAY ROADWAY
APPROACH LANE

DRAWING 405-01-E(1)
DRAWING 405-01-E(2) - FLAGGING OPERATIONS
MULTIPLE FLAGGERS
TWO-LANE TWO-WAY ROADWAYS
PRIMARY & SECONDARY ROUTES
WORK ACTIVITY AREA
INTERSECTIONS with
LOW SPEED
< / = 35 MPH
MULTILANE ROADWAYS

DRAWING 405-01-F(1)
DRAWING 405-01-F(2) - FLAGGING OPERATIONS
MULTIPLE FLAGGERS
TWO-LANE TWO-WAY ROADWAYS
PRIMARY & SECONDARY ROUTES
WORK ACTIVITY AREA
INTERSECTIONS with
INTERMEDIATE SPEED to HIGH SPEED
40 MPH - 60 MPH
MULTILANE ROADWAYS

DRAWING 405-02 - FLAGGING OPERATIONS
SINGLE FLAGGER OPERATION
LOW VOLUME
LOW SPEED TO INTERMEDIATE SPEED
TWO-LANE TWO-WAY ROADWAYS
PRIMARY & SECONDARY ROUTES

SHOULDER CLOSURES

DRAWING 515-01-A - RIGHT SHOULDER CLOSURE
CASE I / CASE II
TWO-LANE TWO-WAY ROADWAYS
PRIMARY & SECONDARY ROUTES

MULTILANE SECONDARY AND PRIMARY ROADWAYS

Lane closures should be utilized for work activities that require equipment, personnel, materials, or any vehicles to encroach upon a travel lane or within 1 foot of a travel lane. When the work may be performed without the necessity for equipment, personnel, materials, or vehicles to encroach within 1 foot of an adjacent travel or without creating a hazard to passing motorists, utilize shoulder closures.

TYPICAL DRAWING APPLICATIONS

LANE CLOSURES

- DRAWING 505-01 - LANE CLOSURE
LOW SPEED MULTILANE
</= 35 MPH
PRIMARY & SECONDARY ROUTES
- DRAWING 505-03-A - LANE CLOSURE
INTERMEDIATE SPEED TO HIGH SPEED
40 MPH - 60 MPH
MULTILANE
PRIMARY & SECONDARY ROUTES

SHOULDER CLOSURES

- DRAWING 515-01-B - RIGHT SHOULDER CLOSURE
CASE I / CASE II
MULTILANE
PRIMARY & SECONDARY ROUTES
- DRAWING 515-02 - LEFT SHOULDER CLOSURE
CASE I / CASE I
MULTILANE
PRIMARY & SECONDARY ROUTES
- DRAWING 515-03 - LEFT SHOULDER CLOSURE
CASE I / CASE II
MULTILANE
PRIMARY & SECONDARY ROUTES

INTERSTATE ROADWAYS

Utilize intermittent mobile operations for these work activities under the following conditions:

Condition 2 - The maximum time duration of a stop is 30 minutes if the vehicles remain in the shoulder areas in their entirety with no encroachment upon an adjacent travel lane.

During intermittent mobile operations, a shadow vehicle should be utilized when the stopping sight distance interval between the work vehicle or road machinery and an approaching motorist is unavailable based upon the posted regulatory speed limit of the work location.

Standard shoulder closures may be used for work activities that cannot be conducted under the conditions required for intermittent mobile operations.

Lane closures should be utilized for planned work activities that require equipment, personnel, materials, or any vehicles to encroach upon a travel lane or within 10 feet of a travel lane. When the work may be performed without the necessity for equipment, personnel, materials, or vehicles to encroach within 10 feet of an adjacent travel or without creating a hazard to passing motorists, utilize shoulder closures.

Lane closures should be utilized for work activities that cannot be conducted under the conditions required for intermittent mobile operations or standard shoulder closures.

TYPICAL DRAWING APPLICATIONS

LANE CLOSURES

- | | | |
|-------------------------|---|--|
| DRAWING 510-01-A | - | LANE CLOSURE
INTERSTATE ROUTES |
| DRAWING 510-01-B | - | LANE CLOSURE
EXIT / ENTRANCE RAMPS
INTERSTATE ROUTES |

SHOULDER CLOSURES

- | | | |
|-----------------------|---|--|
| DRAWING 520-01 | - | RIGHT SHOULDER CLOSURE
CASE I / CASE II
INTERSTATE ROUTES |
| DRAWING 520-02 | - | LEFT SHOULDER CLOSURE
CASE I / CASE I
NARROW MEDIAN
INTERSTATE ROUTES |
| DRAWING 520-03 | - | LEFT SHOULDER CLOSURE
CASE I / CASE I
WIDE MEDIAN
INTERSTATE ROUTES |
| DRAWING 520-04 | - | LEFT SHOULDER CLOSURE
CASE I / CASE II
WIDE MEDIAN
INTERSTATE ROUTES |
| DRAWING 520-05 | - | LEFT SHOULDER CLOSURE
CASE II / CASE II
WIDE MEDIAN
INTERSTATE ROUTES |

MOBILIZED SHOULDER OPERATIONS

- DRAWING 530-03** - MOBILIZED SHOULDER OPERATIONS
PEDESTRIAN WORKERS – MAJOR ENCROACHMENT
UPON PAVED SHOULDER
ROAD MACHINERY – MAJOR ENCROACHMENT
UPON TRAVEL LANE
INTERSTATE ROUTES

MOBILE OPERATIONS – INTERMITTENT

- DRAWING 535-01-A** - MOBILE OPERATIONS – INTERMITTENT
STOPPING SIGHT DISTANCE
VEHICLE TRAIN REQUIREMENTS
VERTICAL CURVE (HILL)
- DRAWING 535-01-B** - MOBILE OPERATIONS – INTERMITTENT
STOPPING SIGHT DISTANCE
VEHICLE TRAIN REQUIREMENTS
HORIZONTAL CURVE (CURVE)
- DRAWING 535-04-D(1)** - MOBILE OPERATIONS – INTERMITTENT
HIGH VOLUME
HIGH SPEED
INTERSTATE ROUTES
- DRAWING 535-04-E** - MOBILE OPERATIONS – INTERMITTENT
HIGH VOLUME
HIGH SPEED
INTERIOR TRAVEL LANE OPERATIONS
INTERSTATE ROUTES

WORK DESCRIPTION 7 Hazardous Waste

TRAFFIC CONTROL

CONDUCT THESE OPERATIONS PER DIRECTION OF THE DIRECTOR OF MAINTENANCE.

PERFORMANCE ACTIVITY 410

ROADWAY CLEANING

WORK DESCRIPTION 1
WORK DESCRIPTION 2

Clean by Hand
Clean by Machine

410 ROADWAY CLEANING

ACTIVITY DESCRIPTION

Clean roadway features such as curb & gutter, pavement edges, paved shoulders, bike paths, sidewalks, gore areas and barrier walls, etc.

WORK DESCRIPTION 1 Clean by Hand

TRAFFIC CONTROL

TWO-LANE TWO-WAY ROADWAYS

Mobilized shoulder operations should be implemented for work activities requiring only one (1) single equipment unit that progress along the roadway at a slow pace and may require equipment or vehicles to encroach upon a travel lane beyond 2 feet and at times may occupy the entire travel lane adjacent to the shoulder in which the work is being conducted.

Utilize a shadow vehicle when the stopping sight distance interval between the work vehicle or road machinery and an approaching motorist is unavailable based upon the posted regulatory speed limit of the work location.

Shoulder closures may be installed for work activities that require pedestrian workers to perform work activities beyond 1 foot but within 15 feet of a travel lane.

Flagging operations may be installed for work activities that require pedestrian workers to encroach upon the travel lane or perform work activities within 1 foot of the adjacent travel lane.

Flagging operations may be installed for work activities that require equipment or any vehicles to encroach upon a travel lane beyond 2 feet and at times may occupy the entire travel lane adjacent to the shoulder in which the work is being conducted.

(Brief periodic encroachments upon the adjacent travel lane for the equipment to relocate or bypass structures such as guardrail locations or bridge structures are acceptable.)

TYPICAL DRAWING APPLICATIONS

FLAGGING OPERATIONS

DRAWING 405-01-A	-	FLAGGING OPERATIONS MULTIPLE FLAGGERS TWO-LANE TWO-WAY ROADWAYS PRIMARY & SECONDARY ROUTES
DRAWING 405-01-B(1)	-	FLAGGING OPERATIONS MULTIPLE FLAGGERS TWO-LANE TWO-WAY ROADWAYS PRIMARY & SECONDARY ROUTES STOP SIGN CONTROLLED SIDE ROADS
DRAWING 405-01-B(2)	-	FLAGGING OPERATIONS MULTIPLE FLAGGERS TWO-LANE TWO-WAY ROADWAYS PRIMARY & SECONDARY ROUTES 4-WAY STOP CONTROLLED INTERSECTION
DRAWING 405-01-C(1)	-	FLAGGING OPERATIONS MULTIPLE FLAGGERS TWO-LANE TWO-WAY ROADWAYS PRIMARY & SECONDARY ROUTES TRAFFIC SIGNAL CONTROLLED INTERSECTION LAW ENFORCEMENT OFFICER(S)

DRAWING 405-01-C(2) - FLAGGING OPERATIONS
MULTIPLE FLAGGERS
TWO-LANE TWO-WAY ROADWAYS
PRIMARY & SECONDARY ROUTES
TRAFFIC SIGNAL CONTROLLED INTERSECTION
FLAGGERS

DRAWING 405-01-D(1) - FLAGGING OPERATIONS
MULTIPLE FLAGGERS
TWO-LANE TWO-WAY ROADWAYS
PRIMARY & SECONDARY ROUTES
WORK ACTIVITY AREA
BEGINNING at an
INTERSECTION with a
TWO-LANE TWO-WAY ROADWAY
DEPARTURE LANE

DRAWING 405-01-D(2) - FLAGGING OPERATIONS
MULTIPLE FLAGGERS
TWO-LANE TWO-WAY ROADWAYS
PRIMARY & SECONDARY ROUTES
WORK ACTIVITY AREA
TERMINATING at an
INTERSECTION with a
TWO-LANE TWO-WAY ROADWAY
APPROACH LANE

DRAWING 405-01-E(1)
DRAWING 405-01-E(2) - FLAGGING OPERATIONS
MULTIPLE FLAGGERS
TWO-LANE TWO-WAY ROADWAYS
PRIMARY & SECONDARY ROUTES
WORK ACTIVITY AREA
INTERSECTIONS with
LOW SPEED
< / = 35 MPH
MULTILANE ROADWAYS

DRAWING 405-01-F(1)
DRAWING 405-01-F(2) - FLAGGING OPERATIONS
MULTIPLE FLAGGERS
TWO-LANE TWO-WAY ROADWAYS
PRIMARY & SECONDARY ROUTES
WORK ACTIVITY AREA
INTERSECTIONS with
INTERMEDIATE SPEED to HIGH SPEED
40 MPH - 60 MPH
MULTILANE ROADWAYS

DRAWING 405-02 - FLAGGING OPERATIONS
SINGLE FLAGGER OPERATION
LOW VOLUME
LOW SPEED TO INTERMEDIATE SPEED
TWO-LANE TWO-WAY ROADWAYS
PRIMARY & SECONDARY ROUTES

SHOULDER CLOSURES

DRAWING 515-01-A - RIGHT SHOULDER CLOSURE
CASE I / CASE II
TWO-LANE TWO-WAY ROADWAYS
PRIMARY & SECONDARY ROUTES

DRAWING 515-01-C - RIGHT SHOULDER CLOSURE
LOW SPEED
< / = 35 MPH
PRIMARY & SECONDARY ROUTES
(MINOR ENCROACHMENT)

MOBILIZED SHOULDER OPERATIONS

DRAWING 525-02 - MOBILIZED SHOULDER OPERATIONS
PEDESTRIAN WORKERS – NO ENCROACHMENT
ROAD MACHINERY – MINOR ENCROACHMENT
PRIMARY & SECONDARY ROUTES

MULTILANE SECONDARY AND PRIMARY ROADWAYS

Mobilized shoulder operations should be implemented for work activities requiring only one (1) single equipment unit that progress along the roadway at a slow pace and may require equipment or vehicles to encroach upon a travel lane beyond 2 feet and at times may occupy the entire travel lane adjacent to the shoulder in which the work is being conducted.

Utilize a shadow vehicle when the stopping sight distance interval between the work vehicle or road machinery and an approaching motorist is unavailable based upon the posted regulatory speed limit of the work location.

Shoulder closures may be installed for work activities that require pedestrian workers to perform work activities beyond 1 foot but within 15 feet of a travel lane.

Lane closures may be installed for work activities that require pedestrian workers to encroach upon the travel lane or perform work activities within 1 foot of the adjacent travel lane.

Lane closures may be installed for work activities that require equipment or any vehicles to encroach upon a travel lane beyond 2 feet and at times may occupy the entire travel lane adjacent to the shoulder in which the work is being conducted.

(Brief periodic encroachments upon the adjacent travel lane for the equipment to relocate or bypass structures such as guardrail locations or bridge structures are acceptable.)

TYPICAL DRAWING APPLICATIONS

LANE CLOSURES

DRAWING 505-01 - LANE CLOSURE
LOW SPEED MULTILANE
< / = 35 MPH
PRIMARY & SECONDARY ROUTES

DRAWING 505-03-A - LANE CLOSURE
INTERMEDIATE SPEED TO HIGH SPEED
40 MPH - 60 MPH
MULTILANE
PRIMARY & SECONDARY ROUTES

SHOULDER CLOSURES

DRAWING 515-01-B - RIGHT SHOULDER CLOSURE
CASE I / CASE II
MULTILANE
PRIMARY & SECONDARY ROUTES

DRAWING 515-01-D - LEFT SHOULDER CLOSURE
LOW SPEED
< / = 35 MPH
MULTILANE DIVIDED HIGHWAY
w/ GRASSED EARTH MEDIAN
PRIMARY & SECONDARY ROUTES
(MINOR ENCROACHMENT)

- DRAWING 515-02** - LEFT SHOULDER CLOSURE
CASE I / CASE I
MULTILANE
PRIMARY & SECONDARY ROUTES
- DRAWING 515-03** - LEFT SHOULDER CLOSURE
CASE I / CASE II
MULTILANE
PRIMARY & SECONDARY ROUTES

MOBILIZED SHOULDER OPERATIONS

- DRAWING 525-02** - MOBILIZED SHOULDER OPERATIONS
PEDESTRIAN WORKERS – NO ENCROACHMENT
ROAD MACHINERY – MINOR ENCROACHMENT
PRIMARY & SECONDARY ROUTES
- DRAWING 525-04** - MOBILIZED SHOULDER OPERATIONS
INTERMEDIATE SPEED TO HIGH SPEED
40 MPH - 60 MPH
PEDESTRIAN WORKERS – MAJOR ENCROACHMENT
ROAD MACHINERY – MAJOR ENCROACHMENT
MULTILANE
PRIMARY & SECONDARY ROUTES

INTERSTATE ROADWAYS

Mobilized shoulder operations may be used for work activities that progress along the roadway at a slow pace and require equipment, personnel, materials, or any vehicles to encroach upon the adjacent paved shoulder within the limits specified by the typical drawing applications for interstate mobilized shoulder operations.

Standard shoulder closures should be utilized for work activities that cannot be conducted under the conditions required for mobilized shoulder operations.

(Brief periodic encroachments upon the adjacent travel lane for the equipment to relocate or bypass structures such as guardrail locations or bridge structures are acceptable.)

TYPICAL DRAWING APPLICATIONS

SHOULDER CLOSURES

- DRAWING 520-01** - RIGHT SHOULDER CLOSURE
CASE I / CASE II
INTERSTATE ROUTES
- DRAWING 520-02** - LEFT SHOULDER CLOSURE
CASE I / CASE I
NARROW MEDIAN
INTERSTATE ROUTES
- DRAWING 520-03** - LEFT SHOULDER CLOSURE
CASE I / CASE I
WIDE MEDIAN
INTERSTATE ROUTES
- DRAWING 520-04** - LEFT SHOULDER CLOSURE
CASE I / CASE II
WIDE MEDIAN
INTERSTATE ROUTES
- DRAWING 520-05** - LEFT SHOULDER CLOSURE
CASE II / CASE II
WIDE MEDIAN
INTERSTATE ROUTES

MOBILIZED SHOULDER OPERATIONS

- DRAWING 530-02** - MOBILIZED SHOULDER OPERATIONS
PEDESTRIAN WORKERS – MINOR ENCROACHMENT
UPON PAVED SHOULDER
INTERSTATE ROUTES

- DRAWING 530-03** - MOBILIZED SHOULDER OPERATIONS
PEDESTRIAN WORKERS – MAJOR ENCROACHMENT
UPON PAVED SHOULDER
ROAD MACHINERY – MAJOR ENCROACHMENT
UPON TRAVEL LANE
INTERSTATE ROUTES

WORK DESCRIPTION 2 Clean by Machine

TRAFFIC CONTROL

TWO-LANE TWO-WAY ROADWAYS

Utilize intermittent mobile operations for these work activities under the following conditions:

Condition 1 - The maximum time duration of a stop is 15 minutes if the work vehicle and/or the shadow vehicle encroach upon a travel lane more than 2 feet.

Condition 2 - The maximum time duration of a stop is 30 minutes if the work vehicle and/or the shadow vehicle encroach upon a travel lane 2 feet or less.

During intermittent mobile operations, utilize a shadow vehicle when the stopping sight distance interval between the work vehicle or road machinery and an approaching motorist is unavailable based upon the posted regulatory speed limit of the work location.

Flagging operations are required for work activities that cannot be conducted under the conditions required for intermittent mobile operations.

TYPICAL DRAWING APPLICATIONS

FLAGGING OPERATIONS

- | | | |
|----------------------------|---|---|
| DRAWING 405-01-A | - | FLAGGING OPERATIONS
MULTIPLE FLAGGERS
TWO-LANE TWO-WAY ROADWAYS
PRIMARY & SECONDARY ROUTES |
| DRAWING 405-01-B(1) | - | FLAGGING OPERATIONS
MULTIPLE FLAGGERS
TWO-LANE TWO-WAY ROADWAYS
PRIMARY & SECONDARY ROUTES
STOP SIGN CONTROLLED SIDE ROADS |
| DRAWING 405-01-B(2) | - | FLAGGING OPERATIONS
MULTIPLE FLAGGERS
TWO-LANE TWO-WAY ROADWAYS
PRIMARY & SECONDARY ROUTES
4-WAY STOP CONTROLLED INTERSECTION |
| DRAWING 405-01-C(1) | - | FLAGGING OPERATIONS
MULTIPLE FLAGGERS
TWO-LANE TWO-WAY ROADWAYS
PRIMARY & SECONDARY ROUTES
TRAFFIC SIGNAL CONTROLLED INTERSECTION
LAW ENFORCEMENT OFFICER(S) |
| DRAWING 405-01-C(2) | - | FLAGGING OPERATIONS
MULTIPLE FLAGGERS
TWO-LANE TWO-WAY ROADWAYS
PRIMARY & SECONDARY ROUTES
TRAFFIC SIGNAL CONTROLLED INTERSECTION
FLAGGERS |
| DRAWING 405-01-D(1) | - | FLAGGING OPERATIONS
MULTIPLE FLAGGERS
TWO-LANE TWO-WAY ROADWAYS
PRIMARY & SECONDARY ROUTES
WORK ACTIVITY AREA
BEGINNING at an
INTERSECTION with a
TWO-LANE TWO-WAY ROADWAY
DEPARTURE LANE |

- DRAWING 405-01-D(2)** - FLAGGING OPERATIONS
 MULTIPLE FLAGGERS
 TWO-LANE TWO-WAY ROADWAYS
 PRIMARY & SECONDARY ROUTES
 WORK ACTIVITY AREA
 TERMINATING at an
 INTERSECTION with a
 TWO-LANE TWO-WAY ROADWAY
 APPROACH LANE
- DRAWING 405-01-E(1)**
DRAWING 405-01-E(2) - FLAGGING OPERATIONS
 MULTIPLE FLAGGERS
 TWO-LANE TWO-WAY ROADWAYS
 PRIMARY & SECONDARY ROUTES
 WORK ACTIVITY AREA
 INTERSECTIONS with
 LOW SPEED
 < / = 35 MPH
 MULTILANE ROADWAYS
- DRAWING 405-01-F(1)**
DRAWING 405-01-F(2) - FLAGGING OPERATIONS
 MULTIPLE FLAGGERS
 TWO-LANE TWO-WAY ROADWAYS
 PRIMARY & SECONDARY ROUTES
 WORK ACTIVITY AREA
 INTERSECTIONS with
 INTERMEDIATE SPEED to HIGH SPEED
 40 MPH - 60 MPH
 MULTILANE ROADWAYS
- DRAWING 405-02** - FLAGGING OPERATIONS
 SINGLE FLAGGER OPERATION
 LOW VOLUME
 LOW SPEED TO INTERMEDIATE SPEED
 TWO-LANE TWO-WAY ROADWAYS
 PRIMARY & SECONDARY ROUTES

MOBILE OPERATIONS – INTERMITTENT

- DRAWING 535-01-A** - MOBILE OPERATIONS – INTERMITTENT
 STOPPING SIGHT DISTANCE
 VEHICLE TRAIN REQUIREMENTS
 VERTICAL CURVE (HILL)
- DRAWING 535-01-B** - MOBILE OPERATIONS – INTERMITTENT
 STOPPING SIGHT DISTANCE
 VEHICLE TRAIN REQUIREMENTS
 HORIZONTAL CURVE (CURVE)
- DRAWING 535-02-A** - MOBILE OPERATIONS – INTERMITTENT
 LOW VOLUME
 LOW SPEED
 PRIMARY & SECONDARY ROUTES
- DRAWING 535-02-B** - MOBILE OPERATIONS – INTERMITTENT
 LOW VOLUME
 INTERMEDIATE SPEED TO HIGH SPEED
 PRIMARY & SECONDARY ROUTES
- DRAWING 535-03-A** - MOBILE OPERATIONS – INTERMITTENT
 INTERMEDIATE VOLUME
 LOW SPEED
 PRIMARY & SECONDARY ROUTES

- DRAWING 535-03-B** - MOBILE OPERATIONS – INTERMITTENT
INTERMEDIATE VOLUME
INTERMEDIATE SPEED TO HIGH SPEED
PRIMARY & SECONDARY ROUTES
- DRAWING 535-04-A** - MOBILE OPERATIONS – INTERMITTENT
HIGH VOLUME
LOW SPEED
PRIMARY & SECONDARY ROUTES
- DRAWING 535-04-B** - MOBILE OPERATIONS – INTERMITTENT
HIGH VOLUME
LOW SPEED
INTERIOR TRAVEL LANE OPERATIONS
PRIMARY & SECONDARY ROUTES
- DRAWING 535-04-C** - MOBILE OPERATIONS – INTERMITTENT
HIGH VOLUME
INTERMEDIATE SPEED TO HIGH SPEED
PRIMARY & SECONDARY ROUTES

MULTILANE SECONDARY AND PRIMARY ROADWAYS

Utilize intermittent mobile operations for these work activities under the following conditions:

Condition 1 - The maximum time duration of a stop is 15 minutes if the work vehicle and/or the shadow vehicle encroach upon a travel lane more than 2 feet.

Condition 2 - The maximum time duration of a stop is 30 minutes if the work vehicle and/or the shadow vehicle encroach upon a travel lane 2 feet or less.

During intermittent mobile operations, utilize a shadow vehicle when the stopping sight distance interval between the work vehicle or road machinery and an approaching motorist is unavailable based upon the posted regulatory speed limit of the work location.

TYPICAL DRAWING APPLICATIONS

MOBILE OPERATIONS – INTERMITTENT

- DRAWING 535-01-A** - MOBILE OPERATIONS – INTERMITTENT
STOPPING SIGHT DISTANCE
VEHICLE TRAIN REQUIREMENTS
VERTICAL CURVE (HILL)
- DRAWING 535-01-B** - MOBILE OPERATIONS – INTERMITTENT
STOPPING SIGHT DISTANCE
VEHICLE TRAIN REQUIREMENTS
HORIZONTAL CURVE (CURVE)
- DRAWING 535-03-A** - MOBILE OPERATIONS – INTERMITTENT
INTERMEDIATE VOLUME
LOW SPEED
PRIMARY & SECONDARY ROUTES
- DRAWING 535-03-B** - MOBILE OPERATIONS – INTERMITTENT
INTERMEDIATE VOLUME
INTERMEDIATE SPEED TO HIGH SPEED
PRIMARY & SECONDARY ROUTES
- DRAWING 535-04-A** - MOBILE OPERATIONS – INTERMITTENT
HIGH VOLUME
LOW SPEED
PRIMARY & SECONDARY ROUTES

- DRAWING 535-04-B** - MOBILE OPERATIONS – INTERMITTENT
HIGH VOLUME
LOW SPEED
INTERIOR TRAVEL LANE OPERATIONS
PRIMARY & SECONDARY ROUTES
- DRAWING 535-04-C** - MOBILE OPERATIONS – INTERMITTENT
HIGH VOLUME
INTERMEDIATE SPEED TO HIGH SPEED
PRIMARY & SECONDARY ROUTES

INTERSTATE ROADWAYS

Utilize intermittent mobile operations for these work activities under the following conditions:

Condition 1 - The maximum time duration of a stop is 5 minutes if the work vehicle and/or the shadow vehicle encroach upon an adjacent travel lane due to a shoulder area inadequate to accommodate a vehicle in its entirety due to the presence of a concrete median barrier wall or a bridge parapet wall.

Condition 2 - The maximum time duration of a stop is 30 minutes if the vehicles remain in the shoulder areas in their entirety with no encroachment upon an adjacent travel lane.

During intermittent mobile operations, utilize a shadow vehicle when the stopping sight distance interval between the work vehicle or road machinery and an approaching motorist is unavailable based upon the posted regulatory speed limit of the work location.

Mobilized shoulder operations may be used for work activities that progress along the roadway at a slow pace and require equipment, personnel, materials, or any vehicles to encroach upon the adjacent paved shoulder within the limits specified by the typical drawing applications for interstate mobilized shoulder operations.

Standard shoulder closures should be utilized for work activities that cannot be conducted under the conditions required for mobilized shoulder operations.

Lane closures are required for work activities that cannot be conducted under the conditions required for intermittent mobile operations, mobilized shoulder operations or standard shoulder closures.

(Brief periodic encroachments upon the adjacent travel lane for the equipment to relocate or bypass structures such as guardrail locations or bridge structures are acceptable.)

TYPICAL DRAWING APPLICATIONS

LANE CLOSURES

- DRAWING 510-01-A** - LANE CLOSURE
INTERSTATE ROUTES
- DRAWING 510-01-B** - LANE CLOSURE
EXIT / ENTRANCE RAMPS
INTERSTATE ROUTES

SHOULDER CLOSURES

- DRAWING 520-01** - RIGHT SHOULDER CLOSURE
CASE I / CASE II
INTERSTATE ROUTES
- DRAWING 520-02** - LEFT SHOULDER CLOSURE
CASE I / CASE I
NARROW MEDIAN
INTERSTATE ROUTES

- DRAWING 520-03** - LEFT SHOULDER CLOSURE
CASE I / CASE I
WIDE MEDIAN
INTERSTATE ROUTES
- DRAWING 520-04** - LEFT SHOULDER CLOSURE
CASE I / CASE II
WIDE MEDIAN
INTERSTATE ROUTES
- DRAWING 520-05** - LEFT SHOULDER CLOSURE
CASE II / CASE II
WIDE MEDIAN
INTERSTATE ROUTES

MOBILIZED SHOULDER OPERATIONS

- DRAWING 530-01** - MOBILIZED SHOULDER OPERATIONS
ROAD MACHINERY – MAJOR ENCROACHMENT
INTERSTATE ROUTES
- DRAWING 530-02** - MOBILIZED SHOULDER OPERATIONS
PEDESTRIAN WORKERS – MINOR ENCROACHMENT
UPON PAVED SHOULDER
INTERSTATE ROUTES
- DRAWING 530-03** - MOBILIZED SHOULDER OPERATIONS
PEDESTRIAN WORKERS – MAJOR ENCROACHMENT
UPON PAVED SHOULDER
ROAD MACHINERY – MAJOR ENCROACHMENT
UPON TRAVEL LANE
INTERSTATE ROUTES

MOBILE OPERATIONS – INTERMITTENT

- DRAWING 535-01-A** - MOBILE OPERATIONS – INTERMITTENT
STOPPING SIGHT DISTANCE
VEHICLE TRAIN REQUIREMENTS
VERTICAL CURVE (HILL)
- DRAWING 535-01-B** - MOBILE OPERATIONS – INTERMITTENT
STOPPING SIGHT DISTANCE
VEHICLE TRAIN REQUIREMENTS
HORIZONTAL CURVE (CURVE)
- DRAWING 535-04-D(1)** - MOBILE OPERATIONS – INTERMITTENT
HIGH VOLUME
HIGH SPEED
INTERSTATE ROUTES
- DRAWING 535-04-E** - MOBILE OPERATIONS – INTERMITTENT
HIGH VOLUME
HIGH SPEED
INTERIOR TRAVEL LANE OPERATIONS
INTERSTATE ROUTES

PERFORMANCE ACTIVITY 501

DRIVEWAYS

WORK DESCRIPTION 1	Install
WORK DESCRIPTION 2	Remove
WORK DESCRIPTION 3	Maintenance

501 DRIVEWAYS

ACTIVITY DESCRIPTION

Install new driveways, maintenance of existing driveways and removal of existing driveways when necessary.

WORK DESCRIPTION 1 Install
WORK DESCRIPTION 2 Remove
WORK DESCRIPTION 3 Maintenance

TRAFFIC CONTROL

TWO-LANE TWO-WAY ROADWAYS

Shoulder closures may be installed for work activities that require pedestrian workers to perform work activities beyond 1 foot but within 15 feet of a travel lane.

Flagging operations may be installed for work activities that require pedestrian workers to encroach upon the travel lane or perform work activities within 1 foot of the adjacent travel lane.

TYPICAL DRAWING APPLICATIONS

FLAGGING OPERATIONS

DRAWING 405-01-A	-	FLAGGING OPERATIONS MULTIPLE FLAGGERS TWO-LANE TWO-WAY ROADWAYS PRIMARY & SECONDARY ROUTES
DRAWING 405-01-B(1)	-	FLAGGING OPERATIONS MULTIPLE FLAGGERS TWO-LANE TWO-WAY ROADWAYS PRIMARY & SECONDARY ROUTES STOP SIGN CONTROLLED SIDE ROADS
DRAWING 405-01-B(2)	-	FLAGGING OPERATIONS MULTIPLE FLAGGERS TWO-LANE TWO-WAY ROADWAYS PRIMARY & SECONDARY ROUTES 4-WAY STOP CONTROLLED INTERSECTION
DRAWING 405-01-C(1)	-	FLAGGING OPERATIONS MULTIPLE FLAGGERS TWO-LANE TWO-WAY ROADWAYS PRIMARY & SECONDARY ROUTES TRAFFIC SIGNAL CONTROLLED INTERSECTION LAW ENFORCEMENT OFFICER(S)
DRAWING 405-01-C(2)	-	FLAGGING OPERATIONS MULTIPLE FLAGGERS TWO-LANE TWO-WAY ROADWAYS PRIMARY & SECONDARY ROUTES TRAFFIC SIGNAL CONTROLLED INTERSECTION FLAGGERS
DRAWING 405-01-D(1)	-	FLAGGING OPERATIONS MULTIPLE FLAGGERS TWO-LANE TWO-WAY ROADWAYS PRIMARY & SECONDARY ROUTES WORK ACTIVITY AREA BEGINNING at an INTERSECTION with a TWO-LANE TWO-WAY ROADWAY DEPARTURE LANE

- DRAWING 405-01-D(2)** - FLAGGING OPERATIONS
 MULTIPLE FLAGGERS
 TWO-LANE TWO-WAY ROADWAYS
 PRIMARY & SECONDARY ROUTES
 WORK ACTIVITY AREA
 TERMINATING at an
 INTERSECTION with a
 TWO-LANE TWO-WAY ROADWAY
 APPROACH LANE
- DRAWING 405-01-E(1)**
DRAWING 405-01-E(2) - FLAGGING OPERATIONS
 MULTIPLE FLAGGERS
 TWO-LANE TWO-WAY ROADWAYS
 PRIMARY & SECONDARY ROUTES
 WORK ACTIVITY AREA
 INTERSECTIONS with
 LOW SPEED
 < / = 35 MPH
 MULTILANE ROADWAYS
- DRAWING 405-01-F(1)**
DRAWING 405-01-F(2) - FLAGGING OPERATIONS
 MULTIPLE FLAGGERS
 TWO-LANE TWO-WAY ROADWAYS
 PRIMARY & SECONDARY ROUTES
 WORK ACTIVITY AREA
 INTERSECTIONS with
 INTERMEDIATE SPEED to HIGH SPEED
 40 MPH - 60 MPH
 MULTILANE ROADWAYS
- DRAWING 405-02** - FLAGGING OPERATIONS
 SINGLE FLAGGER OPERATION
 LOW VOLUME
 LOW SPEED TO INTERMEDIATE SPEED
 TWO-LANE TWO-WAY ROADWAYS
 PRIMARY & SECONDARY ROUTES

SHOULDER CLOSURES

- DRAWING 515-01-A** - RIGHT SHOULDER CLOSURE
 CASE I / CASE II
 TWO-LANE TWO-WAY ROADWAYS
 PRIMARY & SECONDARY ROUTES
- DRAWING 515-01-C** - RIGHT SHOULDER CLOSURE
 LOW SPEED
 < / = 35 MPH
 PRIMARY & SECONDARY ROUTES
 (MINOR ENCROACHMENT)

MULTILANE SECONDARY AND PRIMARY ROADWAYS

Shoulder closures may be installed for work activities that require pedestrian workers to perform work activities beyond 1 foot but within 15 feet of a travel lane.

Lane closures are required for work activities that require equipment, personnel, materials, or any vehicles to encroach upon a travel lane or within 1 foot of a travel lane. When the work may be performed without the necessity for equipment, personnel, materials, or vehicles to encroach within 1 foot of an adjacent travel.

TYPICAL DRAWING APPLICATIONS

LANE CLOSURES

- | | | |
|-------------------------|---|--|
| DRAWING 505-01 | - | LANE CLOSURE
LOW SPEED MULTILANE
< / = 35 MPH
PRIMARY & SECONDARY ROUTES |
| DRAWING 505-03-A | - | LANE CLOSURE
INTERMEDIATE SPEED TO HIGH SPEED
40 MPH - 60 MPH
MULTILANE
PRIMARY & SECONDARY ROUTES |

SHOULDER CLOSURES

- | | | |
|-------------------------|---|---|
| DRAWING 515-01-B | - | RIGHT SHOULDER CLOSURE
CASE I / CASE II
MULTILANE
PRIMARY & SECONDARY ROUTES |
| DRAWING 515-01-C | - | RIGHT SHOULDER CLOSURE
LOW SPEED
< / = 35 MPH
PRIMARY & SECONDARY ROUTES
(MINOR ENCROACHMENT) |

PERFORMANCE ACTIVITY 504

CONCRETE STRUCTURES

WORK DESCRIPTION 1	Curb Ramp - Install
WORK DESCRIPTION 2	Sidewalk - Repair
WORK DESCRIPTION 3	Install
WORK DESCRIPTION 4	Repair
WORK DESCRIPTION 5	Remove

504 CONCRETE STRUCTURES

ACTIVITY DESCRIPTION

Construct and repair concrete structures such as curb & gutter, sidewalks, islands and medians, and barrier walls.

WORK DESCRIPTION 1 Curb Ramp - Install

WORK DESCRIPTION 2 Sidewalk - Repair

WORK DESCRIPTION 3 Install

WORK DESCRIPTION 4 Repair

WORK DESCRIPTION 5 Remove

TRAFFIC CONTROL

TWO-LANE TWO-WAY ROADWAYS

On low speed roadways with speeds of 35 mph or less, shoulder closures designed for minor encroachment are acceptable for work activities conducted within 30 feet of the near edge of an adjacent travel lane that may require encroachment upon the roadway by personnel, tools, equipment, materials, vehicles, etc. to the extent that may require a reduction of the lane width of an adjacent travel lane to no less than 10 feet.

On low speed roadways with speeds of 35 mph or less, standard shoulder closures are required for work activities that require the presence of personnel, tools, equipment, materials, vehicles, etc. beyond 1 foot but within 30 feet of the near edge of an adjacent travel lane.

On intermediate to high speed roadways, standard shoulder closures are required for work activities that require the presence of personnel, tools, equipment, materials, vehicles, etc. beyond 1 foot but within 30 feet of the near edge of an adjacent travel lane.

On intermediate to high speed roadways, flagging operations are required when the work activities require the presence of personnel, tools, equipment, materials, vehicles, etc. to encroach upon the roadway or to within 1 foot of the near edge of an adjacent travel lane.

Flagging operations are required for work activities that cannot be conducted under the conditions required for standard shoulder closures or shoulder closures with minor encroachment.

TYPICAL DRAWING APPLICATIONS

FLAGGING OPERATIONS

DRAWING 405-01-A	-	FLAGGING OPERATIONS MULTIPLE FLAGGERS TWO-LANE TWO-WAY ROADWAYS PRIMARY & SECONDARY ROUTES
DRAWING 405-01-B(1)	-	FLAGGING OPERATIONS MULTIPLE FLAGGERS TWO-LANE TWO-WAY ROADWAYS PRIMARY & SECONDARY ROUTES STOP SIGN CONTROLLED SIDE ROADS
DRAWING 405-01-B(2)	-	FLAGGING OPERATIONS MULTIPLE FLAGGERS TWO-LANE TWO-WAY ROADWAYS PRIMARY & SECONDARY ROUTES 4-WAY STOP CONTROLLED INTERSECTION
DRAWING 405-01-C(1)	-	FLAGGING OPERATIONS MULTIPLE FLAGGERS TWO-LANE TWO-WAY ROADWAYS PRIMARY & SECONDARY ROUTES TRAFFIC SIGNAL CONTROLLED INTERSECTION LAW ENFORCEMENT OFFICER(S)

DRAWING 405-01-C(2) - FLAGGING OPERATIONS
MULTIPLE FLAGGERS
TWO-LANE TWO-WAY ROADWAYS
PRIMARY & SECONDARY ROUTES
TRAFFIC SIGNAL CONTROLLED INTERSECTION
FLAGGERS

DRAWING 405-01-D(1) - FLAGGING OPERATIONS
MULTIPLE FLAGGERS
TWO-LANE TWO-WAY ROADWAYS
PRIMARY & SECONDARY ROUTES
WORK ACTIVITY AREA
BEGINNING at an
INTERSECTION with a
TWO-LANE TWO-WAY ROADWAY
DEPARTURE LANE

DRAWING 405-01-D(2) - FLAGGING OPERATIONS
MULTIPLE FLAGGERS
TWO-LANE TWO-WAY ROADWAYS
PRIMARY & SECONDARY ROUTES
WORK ACTIVITY AREA
TERMINATING at an
INTERSECTION with a
TWO-LANE TWO-WAY ROADWAY
APPROACH LANE

DRAWING 405-01-E(1)
DRAWING 405-01-E(2) - FLAGGING OPERATIONS
MULTIPLE FLAGGERS
TWO-LANE TWO-WAY ROADWAYS
PRIMARY & SECONDARY ROUTES
WORK ACTIVITY AREA
INTERSECTIONS with
LOW SPEED
< / = 35 MPH
MULTILANE ROADWAYS

DRAWING 405-01-F(1)
DRAWING 405-01-F(2) - FLAGGING OPERATIONS
MULTIPLE FLAGGERS
TWO-LANE TWO-WAY ROADWAYS
PRIMARY & SECONDARY ROUTES
WORK ACTIVITY AREA
INTERSECTIONS with
INTERMEDIATE SPEED to HIGH SPEED
40 MPH - 60 MPH
MULTILANE ROADWAYS

DRAWING 405-02 - FLAGGING OPERATIONS
SINGLE FLAGGER OPERATION
LOW VOLUME
LOW SPEED TO INTERMEDIATE SPEED
TWO-LANE TWO-WAY ROADWAYS
PRIMARY & SECONDARY ROUTES

SHOULDER CLOSURES

DRAWING 515-01-A - RIGHT SHOULDER CLOSURE
CASE I / CASE II
TWO-LANE TWO-WAY ROADWAYS
PRIMARY & SECONDARY ROUTES

DRAWING 515-01-C - RIGHT SHOULDER CLOSURE
 LOW SPEED
 < / = 35 MPH
 PRIMARY & SECONDARY ROUTES
 (MINOR ENCROACHMENT)

MULTILANE SECONDARY AND PRIMARY ROADWAYS

On low speed roadways with speeds of 35 mph or less, shoulder closures designed for minor encroachment are acceptable for work activities conducted within 30 feet of the near edge of an adjacent travel lane that may require encroachment upon the roadway by personnel, tools, equipment, materials, vehicles, etc. to the extent that may require a reduction of the lane width of an adjacent travel lane to no less than 10 feet.

On low speed roadways with speeds of 35 mph or less, standard shoulder closures are required for work activities that require the presence of personnel, tools, equipment, materials, vehicles, etc. beyond 1 foot but within 30 feet of the near edge of an adjacent travel lane.

On low speed roadways, lane closures are required when encroachment of the work activities onto the roadway will reduce the lane width of the adjacent travel lane to less than 10 feet.

On intermediate to high speed roadways, standard shoulder closures are required for work activities that require the presence of personnel, tools, equipment, materials, vehicles, etc. beyond 1 foot but within 30 feet of the near edge of an adjacent travel lane.

On intermediate to high speed roadways, lane closures are required when the work activities require the presence of personnel, tools, equipment, materials, vehicles, etc. to encroach upon the roadway or to within 1 foot of the near edge of an adjacent travel lane.

Lane closures are required for work activities that cannot be conducted under the conditions required for standard shoulder closures or shoulder closures with minor encroachment.

TYPICAL DRAWING APPLICATIONS

LANE CLOSURES

DRAWING 505-01 - LANE CLOSURE
 LOW SPEED MULTILANE
 < / = 35 MPH
 PRIMARY & SECONDARY ROUTES

DRAWING 505-03-A - LANE CLOSURE
 INTERMEDIATE SPEED TO HIGH SPEED
 40 MPH - 60 MPH
 MULTILANE
 PRIMARY & SECONDARY ROUTES

SHOULDER CLOSURES

DRAWING 515-01-B - RIGHT SHOULDER CLOSURE
 CASE I / CASE II
 MULTILANE
 PRIMARY & SECONDARY ROUTES

DRAWING 515-01-C - RIGHT SHOULDER CLOSURE
 LOW SPEED
 < / = 35 MPH
 PRIMARY & SECONDARY ROUTES
 (MINOR ENCROACHMENT)

DRAWING 515-01-D - LEFT SHOULDER CLOSURE
 LOW SPEED
 < / = 35 MPH
 MULTILANE DIVIDED HIGHWAY
 w/ GRASSED EARTH MEDIAN
 PRIMARY & SECONDARY ROUTES
 (MINOR ENCROACHMENT)

- DRAWING 515-02** - LEFT SHOULDER CLOSURE
CASE I / CASE I
MULTILANE
PRIMARY & SECONDARY ROUTES
- DRAWING 515-03** - LEFT SHOULDER CLOSURE
CASE I / CASE II
MULTILANE
PRIMARY & SECONDARY ROUTES

INTERSTATE ROADWAYS

Lane closures are required for work activities that require equipment, personnel, materials, or any vehicles to encroach upon a travel lane or within 10 feet of a travel lane. When the work may be performed without the necessity for equipment, personnel, materials, or vehicles to encroach within 10 feet of an adjacent travel, utilize shoulder closures.

TYPICAL DRAWING APPLICATIONS

LANE CLOSURES

- DRAWING 510-01-A** - LANE CLOSURE
INTERSTATE ROUTES
- DRAWING 510-01-B** - LANE CLOSURE
EXIT / ENTRANCE RAMPS
INTERSTATE ROUTES

SHOULDER CLOSURES

- DRAWING 520-01** - RIGHT SHOULDER CLOSURE
CASE I / CASE II
INTERSTATE ROUTES
- DRAWING 520-02** - LEFT SHOULDER CLOSURE
CASE I / CASE I
NARROW MEDIAN
INTERSTATE ROUTES
- DRAWING 520-03** - LEFT SHOULDER CLOSURE
CASE I / CASE I
WIDE MEDIAN
INTERSTATE ROUTES
- DRAWING 520-04** - LEFT SHOULDER CLOSURE
CASE I / CASE II
WIDE MEDIAN
INTERSTATE ROUTES
- DRAWING 520-05** - LEFT SHOULDER CLOSURE
CASE II / CASE II
WIDE MEDIAN
INTERSTATE ROUTES

PERFORMANCE ACTIVITY 603

SIGNS

WORK DESCRIPTION 3	New Install
WORK DESCRIPTION 4	Maintenance / Replace
WORK DESCRIPTION 6	Temporary

ACTIVITY DESCRIPTION

Install new signs and maintain and replace existing signs.

- WORK DESCRIPTION 3** New Install
- WORK DESCRIPTION 4** Maintenance / Replace
- WORK DESCRIPTION 6** Temporary

TRAFFIC CONTROL

TWO-LANE TWO-WAY ROADWAYS

Utilize intermittent mobile operations for these work activities under the following conditions:

Condition 1 - The maximum time duration of a stop is 15 minutes if the work vehicle and/or the shadow vehicle encroach upon a travel lane more than 2 feet.

Condition 2 - The maximum time duration of a stop is 30 minutes if the work vehicle and/or the shadow vehicle encroach upon a travel lane 2 feet or less.

During intermittent mobile operations, utilize a shadow vehicle when the stopping sight distance interval between the work vehicle or road machinery and an approaching motorist is unavailable based upon the posted regulatory speed limit of the work location.

Flagging operations are required for work activities that cannot be conducted under the conditions required for intermittent mobile operations.

TYPICAL DRAWING APPLICATIONS

FLAGGING OPERATIONS

- DRAWING 405-01-A** - FLAGGING OPERATIONS
MULTIPLE FLAGGERS
TWO-LANE TWO-WAY ROADWAYS
PRIMARY & SECONDARY ROUTES
- DRAWING 405-01-B(1)** - FLAGGING OPERATIONS
MULTIPLE FLAGGERS
TWO-LANE TWO-WAY ROADWAYS
PRIMARY & SECONDARY ROUTES
STOP SIGN CONTROLLED SIDE ROADS
- DRAWING 405-01-B(2)** - FLAGGING OPERATIONS
MULTIPLE FLAGGERS
TWO-LANE TWO-WAY ROADWAYS
PRIMARY & SECONDARY ROUTES
4-WAY STOP CONTROLLED INTERSECTION
- DRAWING 405-01-C(1)** - FLAGGING OPERATIONS
MULTIPLE FLAGGERS
TWO-LANE TWO-WAY ROADWAYS
PRIMARY & SECONDARY ROUTES
TRAFFIC SIGNAL CONTROLLED INTERSECTION
LAW ENFORCEMENT OFFICER(S)
- DRAWING 405-01-C(2)** - FLAGGING OPERATIONS
MULTIPLE FLAGGERS
TWO-LANE TWO-WAY ROADWAYS
PRIMARY & SECONDARY ROUTES
TRAFFIC SIGNAL CONTROLLED INTERSECTION
FLAGGERS

- DRAWING 405-01-D(1)** - FLAGGING OPERATIONS
 MULTIPLE FLAGGERS
 TWO-LANE TWO-WAY ROADWAYS
 PRIMARY & SECONDARY ROUTES
 WORK ACTIVITY AREA
 BEGINNING at an
 INTERSECTION with a
 TWO-LANE TWO-WAY ROADWAY
 DEPARTURE LANE
- DRAWING 405-01-D(2)** - FLAGGING OPERATIONS
 MULTIPLE FLAGGERS
 TWO-LANE TWO-WAY ROADWAYS
 PRIMARY & SECONDARY ROUTES
 WORK ACTIVITY AREA
 TERMINATING at an
 INTERSECTION with a
 TWO-LANE TWO-WAY ROADWAY
 APPROACH LANE
- DRAWING 405-01-E(1)**
DRAWING 405-01-E(2) - FLAGGING OPERATIONS
 MULTIPLE FLAGGERS
 TWO-LANE TWO-WAY ROADWAYS
 PRIMARY & SECONDARY ROUTES
 WORK ACTIVITY AREA
 INTERSECTIONS with
 LOW SPEED
 < / = 35 MPH
 MULTILANE ROADWAYS
- DRAWING 405-01-F(1)**
DRAWING 405-01-F(2) - FLAGGING OPERATIONS
 MULTIPLE FLAGGERS
 TWO-LANE TWO-WAY ROADWAYS
 PRIMARY & SECONDARY ROUTES
 WORK ACTIVITY AREA
 INTERSECTIONS with
 INTERMEDIATE SPEED to HIGH SPEED
 40 MPH - 60 MPH
 MULTILANE ROADWAYS
- DRAWING 405-02** - FLAGGING OPERATIONS
 SINGLE FLAGGER OPERATION
 LOW VOLUME
 LOW SPEED TO INTERMEDIATE SPEED
 TWO-LANE TWO-WAY ROADWAYS
 PRIMARY & SECONDARY ROUTES

MOBILE OPERATIONS – INTERMITTENT

- DRAWING 535-01-A** - MOBILE OPERATIONS – INTERMITTENT
 STOPPING SIGHT DISTANCE
 VEHICLE TRAIN REQUIREMENTS
 VERTICAL CURVE (HILL)
- DRAWING 535-01-B** - MOBILE OPERATIONS – INTERMITTENT
 STOPPING SIGHT DISTANCE
 VEHICLE TRAIN REQUIREMENTS
 HORIZONTAL CURVE (CURVE)
- DRAWING 535-02-A** - MOBILE OPERATIONS – INTERMITTENT
 LOW VOLUME
 LOW SPEED
 PRIMARY & SECONDARY ROUTES

- DRAWING 535-02-B** - MOBILE OPERATIONS – INTERMITTENT
LOW VOLUME
INTERMEDIATE SPEED TO HIGH SPEED
PRIMARY & SECONDARY ROUTES
- DRAWING 535-03-A** - MOBILE OPERATIONS – INTERMITTENT
INTERMEDIATE VOLUME
LOW SPEED
PRIMARY & SECONDARY ROUTES
- DRAWING 535-03-B** - MOBILE OPERATIONS – INTERMITTENT
INTERMEDIATE VOLUME
INTERMEDIATE SPEED TO HIGH SPEED
PRIMARY & SECONDARY ROUTES
- DRAWING 535-04-A** - MOBILE OPERATIONS – INTERMITTENT
HIGH VOLUME
LOW SPEED
PRIMARY & SECONDARY ROUTES
- DRAWING 535-04-B** - MOBILE OPERATIONS – INTERMITTENT
HIGH VOLUME
LOW SPEED
INTERIOR TRAVEL LANE OPERATIONS
PRIMARY & SECONDARY ROUTES
- DRAWING 535-04-C** - MOBILE OPERATIONS – INTERMITTENT
HIGH VOLUME
INTERMEDIATE SPEED TO HIGH SPEED
PRIMARY & SECONDARY ROUTES

MULTILANE SECONDARY AND PRIMARY ROADWAYS

Utilize intermittent mobile operations for these work activities under the following conditions:

Condition 1 - The maximum time duration of a stop is 15 minutes if the work vehicle and/or the shadow vehicle encroach upon a travel lane more than 2 feet.

Condition 2 - The maximum time duration of a stop is 30 minutes if the work vehicle and/or the shadow vehicle encroach upon a travel lane 2 feet or less.

During intermittent mobile operations, utilize a shadow vehicle when the stopping sight distance interval between the work vehicle or road machinery and an approaching motorist is unavailable based upon the posted regulatory speed limit of the work location.

Lane closures are required for work activities that cannot be conducted under the conditions required for intermittent mobile operations as stated above.

TYPICAL DRAWING APPLICATIONS

LANE CLOSURES

- DRAWING 505-01** - LANE CLOSURE
LOW SPEED MULTILANE
< / = 35 MPH
PRIMARY & SECONDARY ROUTES
- DRAWING 505-03-A** - LANE CLOSURE
INTERMEDIATE SPEED TO HIGH SPEED
40 MPH - 60 MPH
MULTILANE
PRIMARY & SECONDARY ROUTES

MOBILE OPERATIONS – INTERMITTENT

DRAWING 535-01-A	-	MOBILE OPERATIONS – INTERMITTENT STOPPING SIGHT DISTANCE VEHICLE TRAIN REQUIREMENTS VERTICAL CURVE (HILL)
DRAWING 535-01-B	-	MOBILE OPERATIONS – INTERMITTENT STOPPING SIGHT DISTANCE VEHICLE TRAIN REQUIREMENTS HORIZONTAL CURVE (CURVE)
DRAWING 535-03-A	-	MOBILE OPERATIONS – INTERMITTENT INTERMEDIATE VOLUME LOW SPEED PRIMARY & SECONDARY ROUTES
DRAWING 535-03-B	-	MOBILE OPERATIONS – INTERMITTENT INTERMEDIATE VOLUME INTERMEDIATE SPEED TO HIGH SPEED PRIMARY & SECONDARY ROUTES
DRAWING 535-04-A	-	MOBILE OPERATIONS – INTERMITTENT HIGH VOLUME LOW SPEED PRIMARY & SECONDARY ROUTES
DRAWING 535-04-B	-	MOBILE OPERATIONS – INTERMITTENT HIGH VOLUME LOW SPEED INTERIOR TRAVEL LANE OPERATIONS PRIMARY & SECONDARY ROUTES
DRAWING 535-04-C	-	MOBILE OPERATIONS – INTERMITTENT HIGH VOLUME INTERMEDIATE SPEED TO HIGH SPEED PRIMARY & SECONDARY ROUTES

INTERSTATE ROADWAYS

Utilize intermittent mobile operations for these work activities under the following conditions:

Condition 1 - The maximum time duration of a stop is 5 minutes if the work vehicle and/or the shadow vehicle encroach upon an adjacent travel lane due to a shoulder area inadequate to accommodate a vehicle in its entirety due to the presence of a concrete median barrier wall or a bridge parapet wall.

Condition 2 - The maximum time duration of a stop is 30 minutes if the vehicles remain in the shoulder areas in their entirety with no encroachment upon an adjacent travel lane.

During intermittent mobile operations, utilize a shadow vehicle when the stopping sight distance interval between the work vehicle or road machinery and an approaching motorist is unavailable based upon the posted regulatory speed limit of the work location.

Standard shoulder closures may be used for work activities that cannot be conducted under the conditions required for intermittent mobile operations when the work may be performed without the necessity for equipment, personnel, materials, or vehicles to encroach within 10 feet of the adjacent travel or without creating a hazard to passing motorists.

Lane closures are required for work activities that cannot be conducted under the conditions required for intermittent mobile operations or standard shoulder closures. Lane closures are required for work activities that require equipment, personnel, materials, or any vehicles to encroach upon a travel lane or within 10 feet of a travel lane.

(Brief periodic encroachments upon the adjacent travel lane for the equipment to relocate or bypass structures such as guardrail locations or bridge structures are acceptable.)

TYPICAL DRAWING APPLICATIONS

LANE CLOSURES

- DRAWING 510-01-A - LANE CLOSURE
INTERSTATE ROUTES
- DRAWING 510-01-B - LANE CLOSURE
EXIT / ENTRANCE RAMP
INTERSTATE ROUTES

SHOULDER CLOSURES

- DRAWING 520-01 - RIGHT SHOULDER CLOSURE
CASE I / CASE II
INTERSTATE ROUTES
- DRAWING 520-02 - LEFT SHOULDER CLOSURE
CASE I / CASE I
NARROW MEDIAN
INTERSTATE ROUTES
- DRAWING 520-03 - LEFT SHOULDER CLOSURE
CASE I / CASE I
WIDE MEDIAN
INTERSTATE ROUTES
- DRAWING 520-04 - LEFT SHOULDER CLOSURE
CASE I / CASE II
WIDE MEDIAN
INTERSTATE ROUTES
- DRAWING 520-05 - LEFT SHOULDER CLOSURE
CASE II / CASE II
WIDE MEDIAN
INTERSTATE ROUTES
- DRAWING 520-06 - SHOULDER CLOSURE
GORE AREA
INTERSTATE ROUTES

MOBILE OPERATIONS – INTERMITTENT

- DRAWING 535-01-A - MOBILE OPERATIONS – INTERMITTENT
STOPPING SIGHT DISTANCE
VEHICLE TRAIN REQUIREMENTS
VERTICAL CURVE (HILL)
- DRAWING 535-01-B - MOBILE OPERATIONS – INTERMITTENT
STOPPING SIGHT DISTANCE
VEHICLE TRAIN REQUIREMENTS
HORIZONTAL CURVE (CURVE)
- DRAWING 535-04-D(1) - MOBILE OPERATIONS – INTERMITTENT
HIGH VOLUME
HIGH SPEED
INTERSTATE ROUTES
- DRAWING 535-04-E - MOBILE OPERATIONS – INTERMITTENT
HIGH VOLUME
HIGH SPEED
INTERIOR TRAVEL LANE OPERATIONS
INTERSTATE ROUTES

PERFORMANCE ACTIVITY 604

TRAFFIC SIGNAL

WORK DESCRIPTION 1	Trouble Call
WORK DESCRIPTION 2	Rebuild
WORK DESCRIPTION 3	Install
WORK DESCRIPTION 4	Revise
WORK DESCRIPTION 5	Repair
WORK DESCRIPTION 6	Preventative Maintenance Inspection
WORK DESCRIPTION 7	Contract Inspection

604 TRAFFIC SIGNAL

ACTIVITY DESCRIPTION

Install and maintain traffic signals.

WORK DESCRIPTION 1 Trouble Call
WORK DESCRIPTION 2 Rebuild
WORK DESCRIPTION 3 Install
WORK DESCRIPTION 4 Revise
WORK DESCRIPTION 5 Repair
WORK DESCRIPTION 6 Preventative Maintenance Inspection
WORK DESCRIPTION 7 Contract Inspection

TRAFFIC CONTROL

TWO-LANE TWO-WAY ROADWAYS

Utilize the traffic control set-ups for traffic signal work operations on two-lane two-way roadways.

TYPICAL DRAWING APPLICATIONS

TRAFFIC SIGNAL WORK OPERATIONS

DRAWING 605-01-A	-	VEHICLE TRAIN TWO-LANE TWO-WAY ROADWAY PRIMARY & SECONDARY ROUTES TRAFFIC SIGNAL WORK ACTIVITIES COMPLETED IN 15 MINUTES OR LESS
DRAWING 605-01-B	-	VEHICLE TRAIN TWO-LANE TWO-WAY ROADWAY PRIMARY & SECONDARY ROUTES TRAFFIC SIGNAL WORK ACTIVITIES THAT EXCEED A TIME DURATION OF 15 MINUTES
DRAWING 606-01	-	VEHICLE TRAIN TWO-LANE TWO-WAY ROADWAY PRIMARY & SECONDARY ROUTES TRAFFIC SIGNAL DETECTION LOOP INSTALLATION STOP BAR LOOPS
DRAWING 606-02	-	VEHICLE TRAIN TWO-LANE TWO-WAY ROADWAY PRIMARY & SECONDARY ROUTES TRAFFIC SIGNAL DETECTION LOOP INSTALLATION SET BACK LOOPS

MULTILANE SECONDARY AND PRIMARY ROADWAYS

Utilize the traffic control set-ups for traffic signal work operations on multilane roadways.

Flagging operations may be necessary to control the flow of traffic on intersecting two-lane two-way roadways.

FLAGGING OPERATIONS

- | | | |
|--|---|--|
| DRAWING 405-01-E(1)
DRAWING 405-01-E(2) | - | FLAGGING OPERATIONS
MULTIPLE FLAGGERS
TWO-LANE TWO-WAY ROADWAYS
PRIMARY & SECONDARY ROUTES
WORK ACTIVITY AREA
INTERSECTIONS with
LOW SPEED
< / = 35 MPH
MULTILANE ROADWAYS |
| DRAWING 405-01-F(1)
DRAWING 405-01-F(2) | - | FLAGGING OPERATIONS
MULTIPLE FLAGGERS
TWO-LANE TWO-WAY ROADWAYS
PRIMARY & SECONDARY ROUTES
WORK ACTIVITY AREA
INTERSECTIONS with
INTERMEDIATE SPEED to HIGH SPEED
40 MPH - 60 MPH
MULTILANE ROADWAYS |

TRAFFIC SIGNAL WORK OPERATIONS

- | | | |
|-------------------------|---|--|
| DRAWING 605-02-A | - | VEHICLE TRAIN
RIGHT LANE CLOSURE
MULTILANE
PRIMARY & SECONDARY ROUTES
TRAFFIC SIGNAL WORK ACTIVITIES
COMPLETED IN 15 MINUTES OR LESS |
| DRAWING 605-02-B | - | VEHICLE TRAIN
RIGHT LANE CLOSURE
MULTILANE
PRIMARY & SECONDARY ROUTES
TRAFFIC SIGNAL WORK ACTIVITIES
THAT EXCEED A TIME DURATION OF 15 MINUTES
BUT NOT MORE THAN 60 MINUTES |
| DRAWING 605-03-A | - | VEHICLE TRAIN
LEFT LANE CLOSURE
MULTILANE
PRIMARY & SECONDARY ROUTES
w/ 2 THROUGH LANES
TRAFFIC SIGNAL WORK ACTIVITIES
COMPLETED IN 15 MINUTES OR LESS |
| DRAWING 605-03-B | - | VEHICLE TRAIN
LEFT LANE CLOSURE
MULTILANE
PRIMARY & SECONDARY ROUTES
w/ 2 THROUGH LANES
TRAFFIC SIGNAL WORK ACTIVITIES
THAT EXCEED A TIME DURATION OF 15 MINUTES
BUT NOT MORE THAN 60 MINUTES |

- DRAWING 605-04-A** - VEHICLE TRAIN
INTERIOR LANE CLOSURE
MULTILANE
PRIMARY & SECONDARY ROUTES
w/ 3 OR MORE THROUGH LANES
TRAFFIC SIGNAL WORK ACTIVITIES
COMPLETED IN 15 MINUTES OR LESS

- DRAWING 605-04-B** - VEHICLE TRAIN
INTERIOR LANE CLOSURE
MULTILANE
PRIMARY & SECONDARY ROUTES
w/ 3 OR MORE THROUGH LANES
TRAFFIC SIGNAL WORK ACTIVITIES
THAT EXCEED A TIME DURATION OF 15 MINUTES
BUT NOT MORE THAN 60 MINUTES

- DRAWING 605-05-A(1)** - SIDE STREET TREATMENT
DUAL LEFT TURN LANES
WORK VEHICLE – RIGHT LANE
MULTILANE
PRIMARY & SECONDARY ROUTES
TRAFFIC SIGNAL WORK ACTIVITIES
COMPLETED IN 15 MINUTES OR LESS

- DRAWING 605-05-A(2)** - SIDE STREET TREATMENT
DUAL LEFT TURN LANES
WORK VEHICLE – LEFT LANE
MULTILANE
PRIMARY & SECONDARY ROUTES
TRAFFIC SIGNAL WORK ACTIVITIES
COMPLETED IN 15 MINUTES OR LESS

- DRAWING 605-05-B(1)** - SIDE STREET TREATMENT
DUAL LEFT TURN LANES
WORK VEHICLE – RIGHT LANE
MULTILANE
PRIMARY & SECONDARY ROUTES
TRAFFIC SIGNAL WORK ACTIVITIES
THAT EXCEED A TIME DURATION OF 15 MINUTES
BUT NOT MORE THAN 60 MINUTES

- DRAWING 605-05-B(2)** - SIDE STREET TREATMENT
DUAL LEFT TURN LANES
WORK VEHICLE – LEFT LANE
MULTILANE
PRIMARY & SECONDARY ROUTES
TRAFFIC SIGNAL WORK ACTIVITIES
THAT EXCEED A TIME DURATION OF 15 MINUTES
BUT NOT MORE THAN 60 MINUTES

- DRAWING 606-03** - VEHICLE TRAIN
RIGHT LANE CLOSURE
MULTILANE
PRIMARY & SECONDARY ROUTES
TRAFFIC SIGNAL DETECTION LOOP INSTALLATION
STOP BAR LOOPS

- DRAWING 606-04-A** - VEHICLE TRAIN
INTERIOR LANE CLOSURE
MULTILANE
PRIMARY & SECONDARY ROUTES
w/ 2 THROUGH LANES
TRAFFIC SIGNAL DETECTION LOOP INSTALLATION
STOP BAR LOOPS

- DRAWING 606-04-B** - VEHICLE TRAIN
INTERIOR LANE CLOSURE
MULTILANE
PRIMARY & SECONDARY ROUTES
w/ 2 THROUGH LANES
CONNECTING THE STOP BAR LOOP
TO THE PULL BOX

- DRAWING 606-05-A** - VEHICLE TRAIN
INTERIOR LANE CLOSURE
MULTILANE
PRIMARY & SECONDARY ROUTES
w/ 3 OR MORE THROUGH LANES
TRAFFIC SIGNAL DETECTION LOOP INSTALLATION
STOP BAR LOOPS

- DRAWING 606-05-B** - VEHICLE TRAIN
INTERIOR LANE CLOSURE
MULTILANE
PRIMARY & SECONDARY ROUTES
w/ 3 or MORE THROUGH LANES
CONNECTING THE STOP BAR LOOP
TO THE PULL BOX

- DRAWING 606-06** - VEHICLE TRAIN
RIGHT LANE CLOSURE
MULTILANE
PRIMARY & SECONDARY ROUTES
w/ 2 THROUGH LANES
TRAFFIC SIGNAL DETECTION LOOP INSTALLATION
SET BACK LOOPS

- DRAWING 606-07** - VEHICLE TRAIN
RIGHT LANE CLOSURE
MULTILANE
PRIMARY & SECONDARY ROUTES
w/ 3 OR MORE THROUGH LANES
TRAFFIC SIGNAL DETECTION LOOP INSTALLATION
SET BACK LOOPS

PERFORMANCE ACTIVITY 605

FLASHERS

WORK DESCRIPTION 1	Trouble Call
WORK DESCRIPTION 2	Rebuild
WORK DESCRIPTION 3	Install
WORK DESCRIPTION 4	Revise
WORK DESCRIPTION 5	Repair
WORK DESCRIPTION 6	Preventative Maintenance Inspection
WORK DESCRIPTION 7	Contract Inspection

SHOULDER - STRUCTURE MOUNTED
OVERHEAD - SPAN WIRE MOUNTED

605 FLASHERS

ACTIVITY DESCRIPTION

Install and maintain flashers.

WORK DESCRIPTION 1 Trouble Call
WORK DESCRIPTION 2 Rebuild
WORK DESCRIPTION 3 Install
WORK DESCRIPTION 4 Revise
WORK DESCRIPTION 5 Repair
WORK DESCRIPTION 6 Preventative Maintenance Inspection
WORK DESCRIPTION 7 Contract Inspection

SHOULDER - STRUCTURE MOUNTED

TRAFFIC CONTROL

TWO-LANE TWO-WAY ROADWAYS

Utilize intermittent mobile operations for these work activities under the following conditions:

Condition 1 - The maximum time duration of a stop is 15 minutes if the work vehicle and/or the shadow vehicle encroach upon a travel lane more than 2 feet.

Condition 2 - The maximum time duration of a stop is 30 minutes if the work vehicle and/or the shadow vehicle encroach upon a travel lane 2 feet or less.

During intermittent mobile operations, utilize a shadow vehicle when the stopping sight distance interval between the work vehicle or road machinery and an approaching motorist is unavailable based upon the posted regulatory speed limit of the work location.

Utilize shoulder closures for work activities that cannot be conducted in 30 minutes or less and do require equipment, personnel, materials, or any vehicles to encroach upon a travel lane or within 1 foot of a travel lane. When the work may be performed without the necessity for equipment, personnel, materials, or vehicles to encroach within 1 foot of the adjacent travel, utilize right shoulder closures.

Flagging operations are required for work activities that cannot be conducted under the conditions required for intermittent mobile operations or right shoulder closures.

TYPICAL DRAWING APPLICATIONS

FLAGGING OPERATIONS

DRAWING 405-01-A	-	FLAGGING OPERATIONS MULTIPLE FLAGGERS TWO-LANE TWO-WAY ROADWAYS PRIMARY & SECONDARY ROUTES
DRAWING 405-01-B(1)	-	FLAGGING OPERATIONS MULTIPLE FLAGGERS TWO-LANE TWO-WAY ROADWAYS PRIMARY & SECONDARY ROUTES STOP SIGN CONTROLLED SIDE ROADS
DRAWING 405-01-B(2)	-	FLAGGING OPERATIONS MULTIPLE FLAGGERS TWO-LANE TWO-WAY ROADWAYS PRIMARY & SECONDARY ROUTES 4-WAY STOP CONTROLLED INTERSECTION

- DRAWING 405-01-C(1)** - FLAGGING OPERATIONS
MULTIPLE FLAGGERS
TWO-LANE TWO-WAY ROADWAYS
PRIMARY & SECONDARY ROUTES
TRAFFIC SIGNAL CONTROLLED INTERSECTION
LAW ENFORCEMENT OFFICER(S)
- DRAWING 405-01-C(2)** - FLAGGING OPERATIONS
MULTIPLE FLAGGERS
TWO-LANE TWO-WAY ROADWAYS
PRIMARY & SECONDARY ROUTES
TRAFFIC SIGNAL CONTROLLED INTERSECTION
FLAGGERS
- DRAWING 405-01-D(1)** - FLAGGING OPERATIONS
MULTIPLE FLAGGERS
TWO-LANE TWO-WAY ROADWAYS
PRIMARY & SECONDARY ROUTES
WORK ACTIVITY AREA
BEGINNING at an
INTERSECTION with a
TWO-LANE TWO-WAY ROADWAY
DEPARTURE LANE
- DRAWING 405-01-D(2)** - FLAGGING OPERATIONS
MULTIPLE FLAGGERS
TWO-LANE TWO-WAY ROADWAYS
PRIMARY & SECONDARY ROUTES
WORK ACTIVITY AREA
TERMINATING at an
INTERSECTION with a
TWO-LANE TWO-WAY ROADWAY
APPROACH LANE
- DRAWING 405-01-E(1)**
DRAWING 405-01-E(2) - FLAGGING OPERATIONS
MULTIPLE FLAGGERS
TWO-LANE TWO-WAY ROADWAYS
PRIMARY & SECONDARY ROUTES
WORK ACTIVITY AREA
INTERSECTIONS with
LOW SPEED
< / = 35 MPH
MULTILANE ROADWAYS
- DRAWING 405-01-F(1)**
DRAWING 405-01-F(2) - FLAGGING OPERATIONS
MULTIPLE FLAGGERS
TWO-LANE TWO-WAY ROADWAYS
PRIMARY & SECONDARY ROUTES
WORK ACTIVITY AREA
INTERSECTIONS with
INTERMEDIATE SPEED to HIGH SPEED
40 MPH - 60 MPH
MULTILANE ROADWAYS
- DRAWING 405-02** - FLAGGING OPERATIONS
SINGLE FLAGGER OPERATION
LOW VOLUME
LOW SPEED TO INTERMEDIATE SPEED
TWO-LANE TWO-WAY ROADWAYS
PRIMARY & SECONDARY ROUTES

MOBILE OPERATIONS – INTERMITTENT

- DRAWING 535-01-A** - MOBILE OPERATIONS – INTERMITTENT
STOPPING SIGHT DISTANCE
VEHICLE TRAIN REQUIREMENTS
VERTICAL CURVE (HILL)
- DRAWING 535-01-B** - MOBILE OPERATIONS – INTERMITTENT
STOPPING SIGHT DISTANCE
VEHICLE TRAIN REQUIREMENTS
HORIZONTAL CURVE (CURVE)
- DRAWING 535-02-A** - MOBILE OPERATIONS – INTERMITTENT
LOW VOLUME
LOW SPEED
PRIMARY & SECONDARY ROUTES
- DRAWING 535-02-B** - MOBILE OPERATIONS – INTERMITTENT
LOW VOLUME
INTERMEDIATE SPEED TO HIGH SPEED
PRIMARY & SECONDARY ROUTES
- DRAWING 535-03-A** - MOBILE OPERATIONS – INTERMITTENT
INTERMEDIATE VOLUME
LOW SPEED
PRIMARY & SECONDARY ROUTES
- DRAWING 535-03-B** - MOBILE OPERATIONS – INTERMITTENT
INTERMEDIATE VOLUME
INTERMEDIATE SPEED TO HIGH SPEED
PRIMARY & SECONDARY ROUTES
- DRAWING 535-04-A** - MOBILE OPERATIONS – INTERMITTENT
HIGH VOLUME
LOW SPEED
PRIMARY & SECONDARY ROUTES
- DRAWING 535-04-B** - MOBILE OPERATIONS – INTERMITTENT
HIGH VOLUME
LOW SPEED
INTERIOR TRAVEL LANE OPERATIONS
PRIMARY & SECONDARY ROUTES
- DRAWING 535-04-C** - MOBILE OPERATIONS – INTERMITTENT
HIGH VOLUME
INTERMEDIATE SPEED TO HIGH SPEED
PRIMARY & SECONDARY ROUTES

MULTILANE SECONDARY AND PRIMARY ROADWAYS

TYPICAL DRAWING APPLICATIONS

Utilize intermittent mobile operations for these work activities under the following conditions:

Condition 1 - The maximum time duration of a stop is 15 minutes if the work vehicle and/or the shadow vehicle encroach upon a travel lane more than 2 feet.

Condition 2 - The maximum time duration of a stop is 30 minutes if the work vehicle and/or the shadow vehicle encroach upon a travel lane 2 feet or less.

During intermittent mobile operations, utilize a shadow vehicle when the stopping sight distance interval between the work vehicle or road machinery and an approaching motorist is unavailable based upon the posted regulatory speed limit of the work location.

Utilize shoulder closures for work activities that cannot be conducted in 30 minutes or less and do require equipment, personnel, materials, or any vehicles to encroach upon a travel lane or within 1 foot of a travel lane. When the work may be performed without the necessity for equipment, personnel, materials, or vehicles to encroach within 1 foot of the adjacent travel, utilize right shoulder closures.

Lane closures are required for work activities that cannot be conducted under the conditions required for intermittent mobile operations or standard shoulder closures.

TYPICAL DRAWING APPLICATIONS

LANE CLOSURES

- DRAWING 505-01** - LANE CLOSURE
LOW SPEED MULTILANE
< / = 35 MPH
PRIMARY & SECONDARY ROUTES
- DRAWING 505-03-A** - LANE CLOSURE
INTERMEDIATE SPEED TO HIGH SPEED
40 MPH - 60 MPH
MULTILANE
PRIMARY & SECONDARY ROUTES

MOBILE OPERATIONS – INTERMITTENT

- DRAWING 535-01-A** - MOBILE OPERATIONS – INTERMITTENT
STOPPING SIGHT DISTANCE
VEHICLE TRAIN REQUIREMENTS
VERTICAL CURVE (HILL)
- DRAWING 535-01-B** - MOBILE OPERATIONS – INTERMITTENT
STOPPING SIGHT DISTANCE
VEHICLE TRAIN REQUIREMENTS
HORIZONTAL CURVE (CURVE)
- DRAWING 535-03-A** - MOBILE OPERATIONS – INTERMITTENT
INTERMEDIATE VOLUME
LOW SPEED
PRIMARY & SECONDARY ROUTES
- DRAWING 535-03-B** - MOBILE OPERATIONS – INTERMITTENT
INTERMEDIATE VOLUME
INTERMEDIATE SPEED TO HIGH SPEED
PRIMARY & SECONDARY ROUTES
- DRAWING 535-04-A** - MOBILE OPERATIONS – INTERMITTENT
HIGH VOLUME
LOW SPEED
PRIMARY & SECONDARY ROUTES
- DRAWING 535-04-B** - MOBILE OPERATIONS – INTERMITTENT
HIGH VOLUME
LOW SPEED
INTERIOR TRAVEL LANE OPERATIONS
PRIMARY & SECONDARY ROUTES
- DRAWING 535-04-C** - MOBILE OPERATIONS – INTERMITTENT
HIGH VOLUME
INTERMEDIATE SPEED TO HIGH SPEED
PRIMARY & SECONDARY ROUTES

INTERSTATE ROADWAYS

Lane closures are required for work activities that require equipment, personnel, materials, or any vehicles to encroach upon a travel lane or within 10 feet of a travel lane. When the work may be performed without the necessity for equipment, personnel, materials, or vehicles to encroach within 10 feet of an adjacent travel, utilize shoulder closures.

TYPICAL DRAWING APPLICATIONS

LANE CLOSURES

- DRAWING 510-01-A - LANE CLOSURE
INTERSTATE ROUTES
- DRAWING 510-01-B - LANE CLOSURE
EXIT / ENTRANCE RAMPS
INTERSTATE ROUTES

SHOULDER CLOSURES

- DRAWING 520-01 - RIGHT SHOULDER CLOSURE
CASE I / CASE II
INTERSTATE ROUTES
- DRAWING 520-02 - LEFT SHOULDER CLOSURE
CASE I / CASE I
NARROW MEDIAN
INTERSTATE ROUTES
- DRAWING 520-03 - LEFT SHOULDER CLOSURE
CASE I / CASE I
WIDE MEDIAN
INTERSTATE ROUTES
- DRAWING 520-04 - LEFT SHOULDER CLOSURE
CASE I / CASE II
WIDE MEDIAN
INTERSTATE ROUTES
- DRAWING 520-05 - LEFT SHOULDER CLOSURE
CASE II / CASE II
WIDE MEDIAN
INTERSTATE ROUTES

OVERHEAD - SPAN WIRE MOUNTED

TRAFFIC CONTROL

TWO-LANE TWO-WAY ROADWAYS

Utilize the traffic control set-ups for traffic signal work operations on two-lane two-way roadways.

TYPICAL DRAWING APPLICATIONS

TRAFFIC SIGNAL WORK OPERATIONS

- DRAWING 605-01-A** - VEHICLE TRAIN
TWO-LANE TWO-WAY ROADWAY
PRIMARY & SECONDARY ROUTES
TRAFFIC SIGNAL WORK ACTIVITIES
COMPLETED IN 15 MINUTES OR LESS

- DRAWING 605-01-B** - VEHICLE TRAIN
TWO-LANE TWO-WAY ROADWAY
PRIMARY & SECONDARY ROUTES
TRAFFIC SIGNAL WORK ACTIVITIES
THAT EXCEED A TIME DURATION OF 15 MINUTES

MULTILANE SECONDARY AND PRIMARY ROADWAYS

Utilize the traffic control set-ups for traffic signal work operations on multilane roadways.

Flagging operations may be necessary to control the flow of traffic on intersecting two-lane two-way roadways.

FLAGGING OPERATIONS

- DRAWING 405-01-A** - FLAGGING OPERATIONS
MULTIPLE FLAGGERS
TWO-LANE TWO-WAY ROADWAYS
PRIMARY & SECONDARY ROUTES

- DRAWING 405-01-B(1)** - FLAGGING OPERATIONS
MULTIPLE FLAGGERS
TWO-LANE TWO-WAY ROADWAYS
PRIMARY & SECONDARY ROUTES
STOP SIGN CONTROLLED SIDE ROADS

- DRAWING 405-01-B(2)** - FLAGGING OPERATIONS
MULTIPLE FLAGGERS
TWO-LANE TWO-WAY ROADWAYS
PRIMARY & SECONDARY ROUTES
4-WAY STOP CONTROLLED INTERSECTION

- DRAWING 405-01-C(1)** - FLAGGING OPERATIONS
MULTIPLE FLAGGERS
TWO-LANE TWO-WAY ROADWAYS
PRIMARY & SECONDARY ROUTES
TRAFFIC SIGNAL CONTROLLED INTERSECTION
LAW ENFORCEMENT OFFICER(S)

- DRAWING 405-01-C(2)** - FLAGGING OPERATIONS
MULTIPLE FLAGGERS
TWO-LANE TWO-WAY ROADWAYS
PRIMARY & SECONDARY ROUTES
TRAFFIC SIGNAL CONTROLLED INTERSECTION
FLAGGERS

- DRAWING 405-01-D(1)** - FLAGGING OPERATIONS
MULTIPLE FLAGGERS
TWO-LANE TWO-WAY ROADWAYS
PRIMARY & SECONDARY ROUTES
WORK ACTIVITY AREA
BEGINNING at an
INTERSECTION with a
TWO-LANE TWO-WAY ROADWAY
DEPARTURE LANE
- DRAWING 405-01-D(2)** - FLAGGING OPERATIONS
MULTIPLE FLAGGERS
TWO-LANE TWO-WAY ROADWAYS
PRIMARY & SECONDARY ROUTES
WORK ACTIVITY AREA
TERMINATING at an
INTERSECTION with a
TWO-LANE TWO-WAY ROADWAY
APPROACH LANE
- DRAWING 405-01-E(1)**
DRAWING 405-01-E(2) - FLAGGING OPERATIONS
MULTIPLE FLAGGERS
TWO-LANE TWO-WAY ROADWAYS
PRIMARY & SECONDARY ROUTES
WORK ACTIVITY AREA
INTERSECTIONS with
LOW SPEED
< / = 35 MPH
MULTILANE ROADWAYS
- DRAWING 405-01-F(1)**
DRAWING 405-01-F(2) - FLAGGING OPERATIONS
MULTIPLE FLAGGERS
TWO-LANE TWO-WAY ROADWAYS
PRIMARY & SECONDARY ROUTES
WORK ACTIVITY AREA
INTERSECTIONS with
INTERMEDIATE SPEED to HIGH SPEED
40 MPH - 60 MPH
MULTILANE ROADWAYS

TRAFFIC SIGNAL WORK OPERATIONS

- DRAWING 605-02-A** - VEHICLE TRAIN
RIGHT LANE CLOSURE
MULTILANE
PRIMARY & SECONDARY ROUTES
TRAFFIC SIGNAL WORK ACTIVITIES
COMPLETED IN 15 MINUTES OR LESS
- DRAWING 605-02-B** - VEHICLE TRAIN
RIGHT LANE CLOSURE
MULTILANE
PRIMARY & SECONDARY ROUTES
TRAFFIC SIGNAL WORK ACTIVITIES
THAT EXCEED A TIME DURATION OF 15 MINUTES
- DRAWING 605-03-A** - VEHICLE TRAIN
INTERIOR LANE CLOSURE
MULTILANE
PRIMARY & SECONDARY ROUTES
w/ 2 THROUGH LANES
TRAFFIC SIGNAL WORK ACTIVITIES
COMPLETED IN 15 MINUTES OR LESS

- DRAWING 605-03-B** - VEHICLE TRAIN
INTERIOR LANE CLOSURE
MULTILANE
PRIMARY & SECONDARY ROUTES
w/ 2 THROUGH LANES
TRAFFIC SIGNAL WORK ACTIVITIES
THAT EXCEED A TIME DURATION OF 15 MINUTES
- DRAWING 605-04-A** - VEHICLE TRAIN
INTERIOR LANE CLOSURE
MULTILANE
PRIMARY & SECONDARY ROUTES
w/ 3 OR MORE THROUGH LANES
TRAFFIC SIGNAL WORK ACTIVITIES
COMPLETED IN 15 MINUTES OR LESS
- DRAWING 605-04-B** - VEHICLE TRAIN
INTERIOR LANE CLOSURE
MULTILANE
PRIMARY & SECONDARY ROUTES
w/ 3 OR MORE THROUGH LANES
TRAFFIC SIGNAL WORK ACTIVITIES
THAT EXCEED A TIME DURATION OF 15 MINUTES

INTERSTATE ROADWAYS

Lane closures are required for work activities that require equipment, personnel, materials, or any vehicles to encroach upon a travel lane or within 10 feet of a travel lane. When the work may be performed without the necessity for equipment, personnel, materials, or vehicles to encroach within 10 feet of the adjacent travel, utilize shoulder closures.

TYPICAL DRAWING APPLICATIONS

LANE CLOSURES

- DRAWING 510-01-A** - LANE CLOSURE
INTERSTATE ROUTES
- DRAWING 510-01-B** - LANE CLOSURE
EXIT / ENTRANCE RAMPS
INTERSTATE ROUTES
- DRAWING 510-02-A** - DUAL LANE CLOSURE
TRANSITION / ACTIVITY AREAS
INTERSTATE ROUTES
- DRAWING 510-02-B** - DUAL LANE CLOSURE
ADVANCE WARNING AREA
INTERSTATE ROUTES
- DRAWING 510-02-C** - DUAL LANE CLOSURE
EXIT / ENTRANCE RAMPS
INTERSTATE ROUTES

SHOULDER CLOSURES

- DRAWING 520-01** - RIGHT SHOULDER CLOSURE
CASE I / CASE II
INTERSTATE ROUTES

- DRAWING 520-02** - LEFT SHOULDER CLOSURE
CASE I / CASE I
NARROW MEDIAN
INTERSTATE ROUTES

- DRAWING 520-03** - LEFT SHOULDER CLOSURE
CASE I / CASE I
WIDE MEDIAN
INTERSTATE ROUTES

- DRAWING 520-04** - LEFT SHOULDER CLOSURE
CASE I / CASE II
WIDE MEDIAN
INTERSTATE ROUTES

- DRAWING 520-05** - LEFT SHOULDER CLOSURE
CASE II / CASE II
WIDE MEDIAN
INTERSTATE ROUTES

PERFORMANCE ACTIVITY 606

PAVEMENT STRIPING

WORK DESCRIPTION 1	New Install / Revise
WORK DESCRIPTION 2	Remove
WORK DESCRIPTION 3	Replace

606 PAVEMENT STRIPING

ACTIVITY DESCRIPTION

Apply or remove pavement markings and retroreflective raised pavement markers by machine.

WORK DESCRIPTION 1 New Install / Revise

WORK DESCRIPTION 2 Remove

WORK DESCRIPTION 3 Replace

TRAFFIC CONTROL

TWO-LANE TWO-WAY ROADWAYS

Continuous mobile operations are required for these work activities when no pedestrian workers are present.

TYPICAL DRAWING APPLICATIONS

MOBILE OPERATIONS – CONTINUOUS

DRAWING 540-01 - MOBILE OPERATIONS
CONTINUOUS
TWO-LANE TWO-WAY ROADWAYS
PRIMARY & SECONDARY ROUTES

MULTILANE SECONDARY AND PRIMARY ROADWAYS

Continuous mobile operations are required for these work activities when no pedestrian workers are present.

TYPICAL DRAWING APPLICATIONS

MOBILE OPERATIONS – CONTINUOUS

DRAWING 540-02-A - MOBILE OPERATIONS
CONTINUOUS
MULTILANE
PRIMARY & SECONDARY ROUTES
EARTH MEDIAN
w/ GRASSED OR PAVED SHOULDERS

DRAWING 540-02-B - MOBILE OPERATIONS
CONTINUOUS
MULTILANE
PRIMARY & SECONDARY ROUTES
PAVED MEDIAN
w/ CURB & GUTTER

INTERSTATE ROADWAYS

Continuous mobile operations are required for these work activities when no pedestrian workers are present.

TYPICAL DRAWING APPLICATIONS

MOBILE OPERATIONS – CONTINUOUS

- | | | |
|-------------------------|---|---|
| DRAWING 540-03-A | - | MOBILE OPERATIONS
CONTINUOUS
INTERSTATE ROUTES
RIGHT TRAVEL LANE |
| DRAWING 540-03-B | - | MOBILE OPERATIONS
CONTINUOUS
INTERSTATE ROUTES
LEFT TRAVEL LANE |
| DRAWING 540-04-A | - | MOBILE OPERATIONS
CONTINUOUS
DUAL LANE CLOSURE
INTERIOR TRAVEL LANE OPERATIONS
INTERSTATE ROUTES
RIGHT TRAVEL LANE |
| DRAWING 540-04-B | - | MOBILE OPERATIONS
CONTINUOUS
DUAL LANE CLOSURE
INTERIOR TRAVEL LANE OPERATIONS
INTERSTATE ROUTES
LEFT TRAVEL LANE |

PERFORMANCE ACTIVITY 607

HAND PLACED MARKINGS

WORK DESCRIPTION 1	New Install / Revise
WORK DESCRIPTION 2	Remove
WORK DESCRIPTION 3	Replace

607 HAND PLACED MARKINGS

ACTIVITY DESCRIPTION

Apply or remove pavement markings, including but not limited to words, symbols, and stop bars and retroreflective raised pavement markers.

WORK DESCRIPTION 1 New Install / Revise

WORK DESCRIPTION 2 Remove

WORK DESCRIPTION 3 Replace

TRAFFIC CONTROL

TWO-LANE TWO-WAY ROADWAYS

Utilize the traffic control set-ups for pavement marking application at intersections on two-lane two-way roadways when pedestrian workers are present.

TYPICAL DRAWING APPLICATIONS

PAVEMENT MARKING APPLICATION – INTERSECTIONS

DRAWING 610-01	-	PAVEMENT MARKING APPLICATION INTERSECTIONS VEHICLE TRAIN TWO-LANE TWO-WAY ROADWAY MULTILANE
-----------------------	---	---

MULTILANE SECONDARY AND PRIMARY ROADWAYS

Utilize the traffic control set-ups for pavement marking application at intersections on multilane roadways when pedestrian workers are present.

TYPICAL DRAWING APPLICATIONS

PAVEMENT MARKING APPLICATION – INTERSECTIONS

DRAWING 610-02	-	PAVEMENT MARKING APPLICATION INTERSECTIONS VEHICLE TRAIN RIGHT LANE CLOSURE MULTILANE
DRAWING 610-03	-	PAVEMENT MARKING APPLICATION INTERSECTIONS VEHICLE TRAIN INTERIOR LANE CLOSURE MULTILANE 2 THROUGH LANES
DRAWING 610-04	-	PAVEMENT MARKING APPLICATION INTERSECTIONS VEHICLE TRAIN INTERIOR LANE CLOSURE MULTILANE 3 OR MORE THROUGH LANES

INTERSTATE ROADWAYS

Lane closures are required for these work activities when pedestrian workers are present.

TYPICAL DRAWING APPLICATIONS

LANE CLOSURES

DRAWING 510-01-A	-	LANE CLOSURE INTERSTATE ROUTES
DRAWING 510-01-B	-	LANE CLOSURE EXIT / ENTRANCE RAMPS INTERSTATE ROUTES
DRAWING 510-02-A	-	DUAL LANE CLOSURE TRANSITION / ACTIVITY AREAS INTERSTATE ROUTES
DRAWING 510-02-B	-	DUAL LANE CLOSURE ADVANCE WARNING AREA INTERSTATE ROUTES
DRAWING 510-02-C	-	DUAL LANE CLOSURE EXIT / ENTRANCE RAMPS INTERSTATE ROUTES

PERFORMANCE ACTIVITY 610

GUARDRAIL

WORK DESCRIPTION 1	Repair
WORK DESCRIPTION 2	Install
WORK DESCRIPTION 3	Remove

610 GUARDRAIL

ACTIVITY DESCRIPTION

Install or repair guardrail and end treatments adjacent to the roadway.

WORK DESCRIPTION 1 Repair
WORK DESCRIPTION 2 Install
WORK DESCRIPTION 3 Remove

TRAFFIC CONTROL

TWO-LANE TWO-WAY ROADWAYS

Flagging operations are required for work activities that require equipment, personnel, materials, or any vehicles to encroach upon a travel lane or within 1 foot of a travel lane. When the work may be performed without the necessity for equipment, personnel, materials, or vehicles to encroach within 1 foot of an adjacent travel, utilize right shoulder closures.

TYPICAL DRAWING APPLICATIONS

FLAGGING OPERATIONS

DRAWING 405-01-A	-	FLAGGING OPERATIONS MULTIPLE FLAGGERS TWO-LANE TWO-WAY ROADWAYS PRIMARY & SECONDARY ROUTES
DRAWING 405-01-B(1)	-	FLAGGING OPERATIONS MULTIPLE FLAGGERS TWO-LANE TWO-WAY ROADWAYS PRIMARY & SECONDARY ROUTES STOP SIGN CONTROLLED SIDE ROADS
DRAWING 405-01-B(2)	-	FLAGGING OPERATIONS MULTIPLE FLAGGERS TWO-LANE TWO-WAY ROADWAYS PRIMARY & SECONDARY ROUTES 4-WAY STOP CONTROLLED INTERSECTION
DRAWING 405-01-C(1)	-	FLAGGING OPERATIONS MULTIPLE FLAGGERS TWO-LANE TWO-WAY ROADWAYS PRIMARY & SECONDARY ROUTES TRAFFIC SIGNAL CONTROLLED INTERSECTION LAW ENFORCEMENT OFFICER(S)
DRAWING 405-01-C(2)	-	FLAGGING OPERATIONS MULTIPLE FLAGGERS TWO-LANE TWO-WAY ROADWAYS PRIMARY & SECONDARY ROUTES TRAFFIC SIGNAL CONTROLLED INTERSECTION FLAGGERS
DRAWING 405-01-D(1)	-	FLAGGING OPERATIONS MULTIPLE FLAGGERS TWO-LANE TWO-WAY ROADWAYS PRIMARY & SECONDARY ROUTES WORK ACTIVITY AREA BEGINNING at an INTERSECTION with a TWO-LANE TWO-WAY ROADWAY DEPARTURE LANE

- DRAWING 405-01-D(2)** - FLAGGING OPERATIONS
MULTIPLE FLAGGERS
TWO-LANE TWO-WAY ROADWAYS
PRIMARY & SECONDARY ROUTES
WORK ACTIVITY AREA
TERMINATING at an
INTERSECTION with a
TWO-LANE TWO-WAY ROADWAY
APPROACH LANE
- DRAWING 405-01-E(1)**
DRAWING 405-01-E(2) - FLAGGING OPERATIONS
MULTIPLE FLAGGERS
TWO-LANE TWO-WAY ROADWAYS
PRIMARY & SECONDARY ROUTES
WORK ACTIVITY AREA
INTERSECTIONS with
LOW SPEED
< / = 35 MPH
MULTILANE ROADWAYS
- DRAWING 405-01-F(1)**
DRAWING 405-01-F(2) - FLAGGING OPERATIONS
MULTIPLE FLAGGERS
TWO-LANE TWO-WAY ROADWAYS
PRIMARY & SECONDARY ROUTES
WORK ACTIVITY AREA
INTERSECTIONS with
INTERMEDIATE SPEED to HIGH SPEED
40 MPH - 60 MPH
MULTILANE ROADWAYS
- DRAWING 405-02** - FLAGGING OPERATIONS
SINGLE FLAGGER OPERATION
LOW VOLUME
LOW SPEED TO INTERMEDIATE SPEED
TWO-LANE TWO-WAY ROADWAYS
PRIMARY & SECONDARY ROUTES
- SHOULDER CLOSURES**
- DRAWING 515-01-A** - RIGHT SHOULDER CLOSURE
CASE I / CASE II
TWO-LANE TWO-WAY ROADWAYS
PRIMARY & SECONDARY ROUTES

MULTILANE SECONDARY AND PRIMARY ROADWAYS

Lane closures are required for work activities that require equipment, personnel, materials, or any vehicles to encroach upon a travel lane or within 1 foot of a travel lane. When the work may be performed without the necessity for equipment, personnel, materials, or vehicles to encroach within 1 foot of an adjacent travel, utilize shoulder closures.

TYPICAL DRAWING APPLICATIONS

LANE CLOSURES

- | | | |
|-------------------------|---|--|
| DRAWING 505-01 | - | LANE CLOSURE
LOW SPEED MULTILANE
< / = 35 MPH
PRIMARY & SECONDARY ROUTES |
| DRAWING 505-03-A | - | LANE CLOSURE
INTERMEDIATE SPEED TO HIGH SPEED
40 MPH - 60 MPH
MULTILANE
PRIMARY & SECONDARY ROUTES |

SHOULDER CLOSURES

- | | | |
|-------------------------|---|--|
| DRAWING 515-01-B | - | RIGHT SHOULDER CLOSURE
CASE I / CASE II
MULTILANE
PRIMARY & SECONDARY ROUTES |
| DRAWING 515-01-C | - | RIGHT SHOULDER CLOSURE
LOW SPEED
< / = 35 MPH
PRIMARY & SECONDARY ROUTES
(MINOR ENCROACHMENT) |
| DRAWING 515-01-D | - | LEFT SHOULDER CLOSURE
LOW SPEED
< / = 35 MPH
MULTILANE DIVIDED HIGHWAY
w/ GRASSED EARTH MEDIAN
PRIMARY & SECONDARY ROUTES
(MINOR ENCROACHMENT) |
| DRAWING 515-02 | - | LEFT SHOULDER CLOSURE
CASE I / CASE I
MULTILANE
PRIMARY & SECONDARY ROUTES |
| DRAWING 515-03 | - | LEFT SHOULDER CLOSURE
CASE I / CASE II
MULTILANE
PRIMARY & SECONDARY ROUTES |

INTERSTATE ROADWAYS

Lane closures are required for work activities that require equipment, personnel, materials, or any vehicles to encroach upon a travel lane or within 10 feet of a travel lane. When the work may be performed without the necessity for equipment, personnel, materials, or vehicles to encroach within 10 feet of an adjacent travel, utilize shoulder closures.

TYPICAL DRAWING APPLICATIONS

LANE CLOSURES

- DRAWING 510-01-A - LANE CLOSURE
INTERSTATE ROUTES
- DRAWING 510-01-B - LANE CLOSURE
EXIT / ENTRANCE RAMPS
INTERSTATE ROUTES

SHOULDER CLOSURES

- DRAWING 520-01 - RIGHT SHOULDER CLOSURE
CASE I / CASE II
INTERSTATE ROUTES
- DRAWING 520-02 - LEFT SHOULDER CLOSURE
CASE I / CASE I
NARROW MEDIAN
INTERSTATE ROUTES
- DRAWING 520-03 - LEFT SHOULDER CLOSURE
CASE I / CASE I
WIDE MEDIAN
INTERSTATE ROUTES
- DRAWING 520-04 - LEFT SHOULDER CLOSURE
CASE I / CASE II
WIDE MEDIAN
INTERSTATE ROUTES
- DRAWING 520-05 - LEFT SHOULDER CLOSURE
CASE II / CASE II
WIDE MEDIAN
INTERSTATE ROUTES

PERFORMANCE ACTIVITY 611

WALLS / FENCES

WORK DESCRIPTION 1	Repair
WORK DESCRIPTION 2	Install
WORK DESCRIPTION 3	Remove

611 WALLS / FENCES

ACTIVITY DESCRIPTION

Install and/or repair retaining (revetment) walls and fences adjacent to the roadway.

WORK DESCRIPTION 1 Repair
WORK DESCRIPTION 2 Install
WORK DESCRIPTION 3 Remove

TRAFFIC CONTROL

TWO-LANE TWO-WAY ROADWAYS

Flagging operations are required for work activities that require equipment, personnel, materials, or any vehicles to encroach upon a travel lane or within 1 foot of a travel lane. When the work may be performed without the necessity for equipment, personnel, materials, or vehicles to encroach within 1 foot of an adjacent travel, utilize right shoulder closures.

TYPICAL DRAWING APPLICATIONS

FLAGGING OPERATIONS

DRAWING 405-01-A	-	FLAGGING OPERATIONS MULTIPLE FLAGGERS TWO-LANE TWO-WAY ROADWAYS PRIMARY & SECONDARY ROUTES
DRAWING 405-01-B(1)	-	FLAGGING OPERATIONS MULTIPLE FLAGGERS TWO-LANE TWO-WAY ROADWAYS PRIMARY & SECONDARY ROUTES STOP SIGN CONTROLLED SIDE ROADS
DRAWING 405-01-B(2)	-	FLAGGING OPERATIONS MULTIPLE FLAGGERS TWO-LANE TWO-WAY ROADWAYS PRIMARY & SECONDARY ROUTES 4-WAY STOP CONTROLLED INTERSECTION
DRAWING 405-01-C(1)	-	FLAGGING OPERATIONS MULTIPLE FLAGGERS TWO-LANE TWO-WAY ROADWAYS PRIMARY & SECONDARY ROUTES TRAFFIC SIGNAL CONTROLLED INTERSECTION LAW ENFORCEMENT OFFICER(S)
DRAWING 405-01-C(2)	-	FLAGGING OPERATIONS MULTIPLE FLAGGERS TWO-LANE TWO-WAY ROADWAYS PRIMARY & SECONDARY ROUTES TRAFFIC SIGNAL CONTROLLED INTERSECTION FLAGGERS
DRAWING 405-01-D(1)	-	FLAGGING OPERATIONS MULTIPLE FLAGGERS TWO-LANE TWO-WAY ROADWAYS PRIMARY & SECONDARY ROUTES WORK ACTIVITY AREA BEGINNING at an INTERSECTION with a TWO-LANE TWO-WAY ROADWAY DEPARTURE LANE

- DRAWING 405-01-D(2)** - FLAGGING OPERATIONS
 MULTIPLE FLAGGERS
 TWO-LANE TWO-WAY ROADWAYS
 PRIMARY & SECONDARY ROUTES
 WORK ACTIVITY AREA
 TERMINATING at an
 INTERSECTION with a
 TWO-LANE TWO-WAY ROADWAY
 APPROACH LANE
- DRAWING 405-01-E(1)**
DRAWING 405-01-E(2) - FLAGGING OPERATIONS
 MULTIPLE FLAGGERS
 TWO-LANE TWO-WAY ROADWAYS
 PRIMARY & SECONDARY ROUTES
 WORK ACTIVITY AREA
 INTERSECTIONS with
 LOW SPEED
 < / = 35 MPH
 MULTILANE ROADWAYS
- DRAWING 405-01-F(1)**
DRAWING 405-01-F(2) - FLAGGING OPERATIONS
 MULTIPLE FLAGGERS
 TWO-LANE TWO-WAY ROADWAYS
 PRIMARY & SECONDARY ROUTES
 WORK ACTIVITY AREA
 INTERSECTIONS with
 INTERMEDIATE SPEED to HIGH SPEED
 40 MPH - 60 MPH
 MULTILANE ROADWAYS
- DRAWING 405-02** - FLAGGING OPERATIONS
 SINGLE FLAGGER OPERATION
 LOW VOLUME
 LOW SPEED TO INTERMEDIATE SPEED
 TWO-LANE TWO-WAY ROADWAYS
 PRIMARY & SECONDARY ROUTES
- SHOULDER CLOSURES**
- DRAWING 515-01-A** - RIGHT SHOULDER CLOSURE
 CASE I / CASE II
 TWO-LANE TWO-WAY ROADWAYS
 PRIMARY & SECONDARY ROUTES

MULTILANE SECONDARY AND PRIMARY ROADWAYS

Lane closures are required for work activities that require equipment, personnel, materials, or any vehicles to encroach upon a travel lane or within 1 foot of a travel lane. When the work may be performed without the necessity for equipment, personnel, materials, or vehicles to encroach within 1 foot of an adjacent travel, utilize shoulder closures.

TYPICAL DRAWING APPLICATIONS

LANE CLOSURES

- DRAWING 505-01** - LANE CLOSURE
LOW SPEED MULTILANE
< / = 35 MPH
PRIMARY & SECONDARY ROUTES
- DRAWING 505-03-A** - LANE CLOSURE
INTERMEDIATE SPEED TO HIGH SPEED
40 MPH - 60 MPH
MULTILANE
PRIMARY & SECONDARY ROUTES

SHOULDER CLOSURES

- DRAWING 515-01-B** - RIGHT SHOULDER CLOSURE
CASE I / CASE II
MULTILANE
PRIMARY & SECONDARY ROUTES
- DRAWING 515-01-C** - RIGHT SHOULDER CLOSURE
LOW SPEED
< / = 35 MPH
PRIMARY & SECONDARY ROUTES
(MINOR ENCROACHMENT)
- DRAWING 515-01-D** - LEFT SHOULDER CLOSURE
LOW SPEED
< / = 35 MPH
MULTILANE DIVIDED HIGHWAY
w/ GRASSED EARTH MEDIAN
PRIMARY & SECONDARY ROUTES
(MINOR ENCROACHMENT)
- DRAWING 515-02** - LEFT SHOULDER CLOSURE
CASE I / CASE I
MULTILANE
PRIMARY & SECONDARY ROUTES
- DRAWING 515-03** - LEFT SHOULDER CLOSURE
CASE I / CASE II
MULTILANE
PRIMARY & SECONDARY ROUTES

INTERSTATE ROADWAYS

Lane closures are required for work activities that require equipment, personnel, materials, or any vehicles to encroach upon a travel lane or within 10 feet of a travel lane. When the work may be performed without the necessity for equipment, personnel, materials, or vehicles to encroach within 10 feet of an adjacent travel, utilize shoulder closures.

TYPICAL DRAWING APPLICATIONS

LANE CLOSURES

- DRAWING 510-01-A - LANE CLOSURE
INTERSTATE ROUTES
- DRAWING 510-01-B - LANE CLOSURE
EXIT / ENTRANCE RAMP
INTERSTATE ROUTES

SHOULDER CLOSURES

- DRAWING 520-01 - RIGHT SHOULDER CLOSURE
CASE I / CASE II
INTERSTATE ROUTES
- DRAWING 520-02 - LEFT SHOULDER CLOSURE
CASE I / CASE I
NARROW MEDIAN
INTERSTATE ROUTES
- DRAWING 520-03 - LEFT SHOULDER CLOSURE
CASE I / CASE I
WIDE MEDIAN
INTERSTATE ROUTES
- DRAWING 520-04 - LEFT SHOULDER CLOSURE
CASE I / CASE II
WIDE MEDIAN
INTERSTATE ROUTES
- DRAWING 520-05 - LEFT SHOULDER CLOSURE
CASE II / CASE II
WIDE MEDIAN
INTERSTATE ROUTES

PERFORMANCE ACTIVITY 613

IMPACT ATTENUATOR

WORK DESCRIPTION 1	Install
WORK DESCRIPTION 2	Remove
WORK DESCRIPTION 3	Repair

613 IMPACT ATTENUATOR

ACTIVITY DESCRIPTION

Repair , install, remove and maintain impact attenuator systems adjacent to the roadway.

WORK DESCRIPTION 1 Install
WORK DESCRIPTION 2 Remove
WORK DESCRIPTION 3 Repair

TRAFFIC CONTROL

TWO-LANE TWO-WAY ROADWAYS

Flagging operations are required for work activities that require equipment, personnel, materials, or any vehicles to encroach upon a travel lane or within 1 foot of a travel lane. When the work may be performed without the necessity for equipment, personnel, materials, or vehicles to encroach within 1 foot of an adjacent travel, utilize right shoulder closures.

TYPICAL DRAWING APPLICATIONS

FLAGGING OPERATIONS

DRAWING 405-01-A	-	FLAGGING OPERATIONS MULTIPLE FLAGGERS TWO-LANE TWO-WAY ROADWAYS PRIMARY & SECONDARY ROUTES
DRAWING 405-01-B(1)	-	FLAGGING OPERATIONS MULTIPLE FLAGGERS TWO-LANE TWO-WAY ROADWAYS PRIMARY & SECONDARY ROUTES STOP SIGN CONTROLLED SIDE ROADS
DRAWING 405-01-B(2)	-	FLAGGING OPERATIONS MULTIPLE FLAGGERS TWO-LANE TWO-WAY ROADWAYS PRIMARY & SECONDARY ROUTES 4-WAY STOP CONTROLLED INTERSECTION
DRAWING 405-01-C(1)	-	FLAGGING OPERATIONS MULTIPLE FLAGGERS TWO-LANE TWO-WAY ROADWAYS PRIMARY & SECONDARY ROUTES TRAFFIC SIGNAL CONTROLLED INTERSECTION LAW ENFORCEMENT OFFICER(S)
DRAWING 405-01-C(2)	-	FLAGGING OPERATIONS MULTIPLE FLAGGERS TWO-LANE TWO-WAY ROADWAYS PRIMARY & SECONDARY ROUTES TRAFFIC SIGNAL CONTROLLED INTERSECTION FLAGGERS
DRAWING 405-01-D(1)	-	FLAGGING OPERATIONS MULTIPLE FLAGGERS TWO-LANE TWO-WAY ROADWAYS PRIMARY & SECONDARY ROUTES WORK ACTIVITY AREA BEGINNING at an INTERSECTION with a TWO-LANE TWO-WAY ROADWAY DEPARTURE LANE

- DRAWING 405-01-D(2)** - FLAGGING OPERATIONS
 MULTIPLE FLAGGERS
 TWO-LANE TWO-WAY ROADWAYS
 PRIMARY & SECONDARY ROUTES
 WORK ACTIVITY AREA
 TERMINATING at an
 INTERSECTION with a
 TWO-LANE TWO-WAY ROADWAY
 APPROACH LANE
- DRAWING 405-01-E(1)**
DRAWING 405-01-E(2) - FLAGGING OPERATIONS
 MULTIPLE FLAGGERS
 TWO-LANE TWO-WAY ROADWAYS
 PRIMARY & SECONDARY ROUTES
 WORK ACTIVITY AREA
 INTERSECTIONS with
 LOW SPEED
 < / = 35 MPH
 MULTILANE ROADWAYS
- DRAWING 405-01-F(1)**
DRAWING 405-01-F(2) - FLAGGING OPERATIONS
 MULTIPLE FLAGGERS
 TWO-LANE TWO-WAY ROADWAYS
 PRIMARY & SECONDARY ROUTES
 WORK ACTIVITY AREA
 INTERSECTIONS with
 INTERMEDIATE SPEED to HIGH SPEED
 40 MPH - 60 MPH
 MULTILANE ROADWAYS
- DRAWING 405-02** - FLAGGING OPERATIONS
 SINGLE FLAGGER OPERATION
 LOW VOLUME
 LOW SPEED TO INTERMEDIATE SPEED
 TWO-LANE TWO-WAY ROADWAYS
 PRIMARY & SECONDARY ROUTES
- SHOULDER CLOSURES**
- DRAWING 515-01-A** - RIGHT SHOULDER CLOSURE
 CASE I / CASE II
 TWO-LANE TWO-WAY ROADWAYS
 PRIMARY & SECONDARY ROUTES

MULTILANE SECONDARY AND PRIMARY ROADWAYS

Lane closures are required for work activities that require equipment, personnel, materials, or any vehicles to encroach upon a travel lane or within 1 foot of a travel lane. When the work may be performed without the necessity for equipment, personnel, materials, or vehicles to encroach within 1 foot of an adjacent travel, utilize shoulder closures.

TYPICAL DRAWING APPLICATIONS

LANE CLOSURES

- DRAWING 505-01** - LANE CLOSURE
LOW SPEED MULTILANE
< / = 35 MPH
PRIMARY & SECONDARY ROUTES
- DRAWING 505-03-A** - LANE CLOSURE
INTERMEDIATE SPEED TO HIGH SPEED
40 MPH - 60 MPH
MULTILANE
PRIMARY & SECONDARY ROUTES

SHOULDER CLOSURES

- DRAWING 515-01-B** - RIGHT SHOULDER CLOSURE
CASE I / CASE II
MULTILANE
PRIMARY & SECONDARY ROUTES
- DRAWING 515-01-C** - RIGHT SHOULDER CLOSURE
LOW SPEED
< / = 35 MPH
PRIMARY & SECONDARY ROUTES
(MINOR ENCROACHMENT)
- DRAWING 515-01-D** - LEFT SHOULDER CLOSURE
LOW SPEED
< / = 35 MPH
MULTILANE DIVIDED HIGHWAY
w/ GRASSED EARTH MEDIAN
PRIMARY & SECONDARY ROUTES
(MINOR ENCROACHMENT)
- DRAWING 515-02** - LEFT SHOULDER CLOSURE
CASE I / CASE I
MULTILANE
PRIMARY & SECONDARY ROUTES
- DRAWING 515-03** - LEFT SHOULDER CLOSURE
CASE I / CASE II
MULTILANE
PRIMARY & SECONDARY ROUTES

INTERSTATE ROADWAYS

Lane closures are required for work activities that require equipment, personnel, materials, or any vehicles to encroach upon a travel lane or within 10 feet of a travel lane. When the work may be performed without the necessity for equipment, personnel, materials, or vehicles to encroach within 10 feet of an adjacent travel, utilize shoulder closures.

TYPICAL DRAWING APPLICATIONS

LANE CLOSURES

- DRAWING 510-01-A** - LANE CLOSURE
INTERSTATE ROUTES
- DRAWING 510-01-B** - LANE CLOSURE
EXIT / ENTRANCE RAMP
INTERSTATE ROUTES

SHOULDER CLOSURES

- DRAWING 520-01** - RIGHT SHOULDER CLOSURE
CASE I / CASE II
INTERSTATE ROUTES
- DRAWING 520-02** - LEFT SHOULDER CLOSURE
CASE I / CASE I
NARROW MEDIAN
INTERSTATE ROUTES
- DRAWING 520-03** - LEFT SHOULDER CLOSURE
CASE I / CASE I
WIDE MEDIAN
INTERSTATE ROUTES
- DRAWING 520-04** - LEFT SHOULDER CLOSURE
CASE I / CASE II
WIDE MEDIAN
INTERSTATE ROUTES
- DRAWING 520-05** - LEFT SHOULDER CLOSURE
CASE II / CASE II
WIDE MEDIAN
INTERSTATE ROUTES

PERFORMANCE ACTIVITY 614

HIGHWAY LIGHTING

WORK DESCRIPTION 1	Install
WORK DESCRIPTION 2	Repair
WORK DESCRIPTION 3	Inspection

614 HIGHWAY LIGHTING

ACTIVITY DESCRIPTION

Install, maintain, repair and inspect highway lighting systems adjacent to the roadway.

WORK DESCRIPTION 1 Install
WORK DESCRIPTION 2 Repair
WORK DESCRIPTION 3 Inspection

TRAFFIC CONTROL

TWO-LANE TWO-WAY ROADWAYS

Flagging operations are required for work activities that require equipment, personnel, materials, or any vehicles to encroach upon a travel lane or within 1 foot of a travel lane. When the work may be performed without the necessity for equipment, personnel, materials, or vehicles to encroach within 1 foot of an adjacent travel, utilize right shoulder closures.

TYPICAL DRAWING APPLICATIONS

FLAGGING OPERATIONS

DRAWING 405-01-A	-	FLAGGING OPERATIONS MULTIPLE FLAGGERS TWO-LANE TWO-WAY ROADWAYS PRIMARY & SECONDARY ROUTES
DRAWING 405-01-B(1)	-	FLAGGING OPERATIONS MULTIPLE FLAGGERS TWO-LANE TWO-WAY ROADWAYS PRIMARY & SECONDARY ROUTES STOP SIGN CONTROLLED SIDE ROADS
DRAWING 405-01-B(2)	-	FLAGGING OPERATIONS MULTIPLE FLAGGERS TWO-LANE TWO-WAY ROADWAYS PRIMARY & SECONDARY ROUTES 4-WAY STOP CONTROLLED INTERSECTION
DRAWING 405-01-C(1)	-	FLAGGING OPERATIONS MULTIPLE FLAGGERS TWO-LANE TWO-WAY ROADWAYS PRIMARY & SECONDARY ROUTES TRAFFIC SIGNAL CONTROLLED INTERSECTION LAW ENFORCEMENT OFFICER(S)
DRAWING 405-01-C(2)	-	FLAGGING OPERATIONS MULTIPLE FLAGGERS TWO-LANE TWO-WAY ROADWAYS PRIMARY & SECONDARY ROUTES TRAFFIC SIGNAL CONTROLLED INTERSECTION FLAGGERS
DRAWING 405-01-D(1)	-	FLAGGING OPERATIONS MULTIPLE FLAGGERS TWO-LANE TWO-WAY ROADWAYS PRIMARY & SECONDARY ROUTES WORK ACTIVITY AREA BEGINNING at an INTERSECTION with a TWO-LANE TWO-WAY ROADWAY DEPARTURE LANE

- DRAWING 405-01-D(2)** - FLAGGING OPERATIONS
 MULTIPLE FLAGGERS
 TWO-LANE TWO-WAY ROADWAYS
 PRIMARY & SECONDARY ROUTES
 WORK ACTIVITY AREA
 TERMINATING at an
 INTERSECTION with a
 TWO-LANE TWO-WAY ROADWAY
 APPROACH LANE
- DRAWING 405-01-E(1)**
DRAWING 405-01-E(2) - FLAGGING OPERATIONS
 MULTIPLE FLAGGERS
 TWO-LANE TWO-WAY ROADWAYS
 PRIMARY & SECONDARY ROUTES
 WORK ACTIVITY AREA
 INTERSECTIONS with
 LOW SPEED
 < / = 35 MPH
 MULTILANE ROADWAYS
- DRAWING 405-01-F(1)**
DRAWING 405-01-F(2) - FLAGGING OPERATIONS
 MULTIPLE FLAGGERS
 TWO-LANE TWO-WAY ROADWAYS
 PRIMARY & SECONDARY ROUTES
 WORK ACTIVITY AREA
 INTERSECTIONS with
 INTERMEDIATE SPEED to HIGH SPEED
 40 MPH - 60 MPH
 MULTILANE ROADWAYS
- DRAWING 405-02** - FLAGGING OPERATIONS
 SINGLE FLAGGER OPERATION
 LOW VOLUME
 LOW SPEED TO INTERMEDIATE SPEED
 TWO-LANE TWO-WAY ROADWAYS
 PRIMARY & SECONDARY ROUTES
- SHOULDER CLOSURES**
- DRAWING 515-01-A** - RIGHT SHOULDER CLOSURE
 CASE I / CASE II
 TWO-LANE TWO-WAY ROADWAYS
 PRIMARY & SECONDARY ROUTES

MULTILANE SECONDARY AND PRIMARY ROADWAYS

Lane closures are required for work activities that require equipment, personnel, materials, or any vehicles to encroach upon a travel lane or within 1 foot of a travel lane. When the work may be performed without the necessity for equipment, personnel, materials, or vehicles to encroach within 1 foot of an adjacent travel, utilize shoulder closures.

TYPICAL DRAWING APPLICATIONS

LANE CLOSURES

- DRAWING 505-01** - LANE CLOSURE
LOW SPEED MULTILANE
< / = 35 MPH
PRIMARY & SECONDARY ROUTES
- DRAWING 505-03-A** - LANE CLOSURE
INTERMEDIATE SPEED TO HIGH SPEED
40 MPH - 60 MPH
MULTILANE
PRIMARY & SECONDARY ROUTES

SHOULDER CLOSURES

- DRAWING 515-01-B** - RIGHT SHOULDER CLOSURE
CASE I / CASE II
MULTILANE
PRIMARY & SECONDARY ROUTES
- DRAWING 515-01-C** - RIGHT SHOULDER CLOSURE
LOW SPEED
< / = 35 MPH
PRIMARY & SECONDARY ROUTES
(MINOR ENCROACHMENT)
- DRAWING 515-01-D** - LEFT SHOULDER CLOSURE
LOW SPEED
< / = 35 MPH
MULTILANE DIVIDED HIGHWAY
w/ GRASSED EARTH MEDIAN
PRIMARY & SECONDARY ROUTES
(MINOR ENCROACHMENT)
- DRAWING 515-02** - LEFT SHOULDER CLOSURE
CASE I / CASE I
MULTILANE
PRIMARY & SECONDARY ROUTES
- DRAWING 515-03** - LEFT SHOULDER CLOSURE
CASE I / CASE II
MULTILANE
PRIMARY & SECONDARY ROUTES

INTERSTATE ROADWAYS

Lane closures are required for work activities that require equipment, personnel, materials, or any vehicles to encroach upon a travel lane or within 10 feet of a travel lane. When the work may be performed without the necessity for equipment, personnel, materials, or vehicles to encroach within 10 feet of an adjacent travel, utilize shoulder closures.

TYPICAL DRAWING APPLICATIONS

LANE CLOSURES

- DRAWING 510-01-A - LANE CLOSURE
INTERSTATE ROUTES
- DRAWING 510-01-B - LANE CLOSURE
EXIT / ENTRANCE RAMPS
INTERSTATE ROUTES

SHOULDER CLOSURES

- DRAWING 520-01 - RIGHT SHOULDER CLOSURE
CASE I / CASE II
INTERSTATE ROUTES
- DRAWING 520-02 - LEFT SHOULDER CLOSURE
CASE I / CASE I
NARROW MEDIAN
INTERSTATE ROUTES
- DRAWING 520-03 - LEFT SHOULDER CLOSURE
CASE I / CASE I
WIDE MEDIAN
INTERSTATE ROUTES
- DRAWING 520-04 - LEFT SHOULDER CLOSURE
CASE I / CASE II
WIDE MEDIAN
INTERSTATE ROUTES
- DRAWING 520-05 - LEFT SHOULDER CLOSURE
CASE II / CASE II
WIDE MEDIAN
INTERSTATE ROUTES

PERFORMANCE ACTIVITY 701

HAZARDOUS CONDITIONS

WORK DESCRIPTION 1	Winter Weather Operations
WORK DESCRIPTION 2	Spill Response
WORK DESCRIPTION 3	Preparation
WORK DESCRIPTION 4	Roadway Clearing

701 HAZARDOUS CONDITIONS

ACTIVITY DESCRIPTION

Any work performed for the response or preparation of a storm or hazardous condition or in response to a spill / accident.

WORK DESCRIPTION 1 Winter Weather Operations

WORK DESCRIPTION 3 Preparation

DURING EMERGENCY SITUATIONS, COMPLETE CLOSURE OF THE ROADWAY MAY BE NECESSARY.

DURING EMERGENCY SITUATIONS, HOURLY AND DISTANCE REQUIREMENTS FOR FLAGGING OPERATIONS, LANE CLOSURES AND SHOULDER CLOSURES MAY BE DISREGARDED PROVIDED THE WORK CREW INCLUDES NO LESS THAN TWO PERSONS AND A WORK VEHICLE FULLY EQUIPPED WITH THE REQUIRED HIGH INTENSITY ROTATING, FLASHING, OSCILLATING OR STROBE AUXILIARY WARNING LIGHTS.

TRAFFIC CONTROL

TWO-LANE TWO-WAY ROADWAYS

Conduct winter weather operations with moving vehicles and equipment. Ensure all vehicles are fully equipped with the required high intensity rotating, flashing, oscillating or strobe auxiliary warning lights.

Road machinery operating within a travel lane should be equipped with high intensity rotating, flashing, oscillating or strobe auxiliary warning lights. If not, utilize a shadow vehicle fully equipped with the required high intensity rotating, flashing, oscillating or strobe auxiliary warning lights as a follow vehicle to the road machinery. The shadow vehicle should maintain a follow distance of approximately 100 feet.

MULTILANE SECONDARY AND PRIMARY ROADWAYS

Conduct winter weather operations with moving vehicles and equipment. Ensure all vehicles are fully equipped with the required high intensity rotating, flashing, oscillating or strobe auxiliary warning lights.

Road machinery operating within a travel lane should be equipped with high intensity rotating, flashing, oscillating or strobe auxiliary warning lights. If not, utilize a shadow vehicle fully equipped with the required high intensity rotating, flashing, oscillating or strobe auxiliary warning lights as a follow vehicle to the road machinery. The shadow vehicle should maintain a follow distance of approximately 100 feet.

INTERSTATE ROADWAYS

Conduct winter weather operations with moving vehicles and equipment. Ensure all vehicles are fully equipped with the required high intensity rotating, flashing, oscillating or strobe auxiliary warning lights.

Road machinery operating within a travel lane should be equipped with high intensity rotating, flashing, oscillating or strobe auxiliary warning lights. If not, utilize a shadow vehicle fully equipped with the required high intensity rotating, flashing, oscillating or strobe auxiliary warning lights as a follow vehicle to the road machinery. The shadow vehicle should maintain a follow distance of approximately 100 feet.

WORK DESCRIPTION 4 Roadway Clearing

DURING EMERGENCY SITUATIONS, COMPLETE CLOSURE OF THE ROADWAY MAY BE NECESSARY.

DURING EMERGENCY SITUATIONS, HOURLY AND DISTANCE REQUIREMENTS FOR FLAGGING OPERATIONS, LANE CLOSURES AND SHOULDER CLOSURES MAY BE DISREGARDED PROVIDED THE WORK CREW INCLUDES NO LESS THAN TWO PERSONS AND A WORK VEHICLE FULLY EQUIPPED WITH THE REQUIRED HIGH INTENSITY ROTATING, FLASHING, OSCILLATING OR STROBE AUXILIARY WARNING LIGHTS.

TRAFFIC CONTROL

TWO-LANE TWO-WAY ROADWAYS

Flagging operations should be utilized for work activities that require equipment, personnel, materials, or any vehicles to encroach upon a travel lane or within 1 foot of a travel lane. When the work may be performed without the necessity for equipment, personnel, materials, or vehicles to encroach within 1 foot of an adjacent travel or without creating a hazard to passing motorists, utilize right shoulder closures.

TYPICAL DRAWING APPLICATIONS

FLAGGING OPERATIONS

DRAWING 405-01-A	-	FLAGGING OPERATIONS MULTIPLE FLAGGERS TWO-LANE TWO-WAY ROADWAYS PRIMARY & SECONDARY ROUTES
DRAWING 405-01-B(1)	-	FLAGGING OPERATIONS MULTIPLE FLAGGERS TWO-LANE TWO-WAY ROADWAYS PRIMARY & SECONDARY ROUTES STOP SIGN CONTROLLED SIDE ROADS
DRAWING 405-01-B(2)	-	FLAGGING OPERATIONS MULTIPLE FLAGGERS TWO-LANE TWO-WAY ROADWAYS PRIMARY & SECONDARY ROUTES 4-WAY STOP CONTROLLED INTERSECTION
DRAWING 405-01-C(1)	-	FLAGGING OPERATIONS MULTIPLE FLAGGERS TWO-LANE TWO-WAY ROADWAYS PRIMARY & SECONDARY ROUTES TRAFFIC SIGNAL CONTROLLED INTERSECTION LAW ENFORCEMENT OFFICER(S)
DRAWING 405-01-C(2)	-	FLAGGING OPERATIONS MULTIPLE FLAGGERS TWO-LANE TWO-WAY ROADWAYS PRIMARY & SECONDARY ROUTES TRAFFIC SIGNAL CONTROLLED INTERSECTION FLAGGERS

- DRAWING 405-01-D(1)** - FLAGGING OPERATIONS
MULTIPLE FLAGGERS
TWO-LANE TWO-WAY ROADWAYS
PRIMARY & SECONDARY ROUTES
WORK ACTIVITY AREA
BEGINNING at an
INTERSECTION with a
TWO-LANE TWO-WAY ROADWAY
DEPARTURE LANE
- DRAWING 405-01-D(2)** - FLAGGING OPERATIONS
MULTIPLE FLAGGERS
TWO-LANE TWO-WAY ROADWAYS
PRIMARY & SECONDARY ROUTES
WORK ACTIVITY AREA
TERMINATING at an
INTERSECTION with a
TWO-LANE TWO-WAY ROADWAY
APPROACH LANE
- DRAWING 405-01-E(1)**
DRAWING 405-01-E(2) - FLAGGING OPERATIONS
MULTIPLE FLAGGERS
TWO-LANE TWO-WAY ROADWAYS
PRIMARY & SECONDARY ROUTES
WORK ACTIVITY AREA
INTERSECTIONS with
LOW SPEED
< / = 35 MPH
MULTILANE ROADWAYS
- DRAWING 405-01-F(1)**
DRAWING 405-01-F(2) - FLAGGING OPERATIONS
MULTIPLE FLAGGERS
TWO-LANE TWO-WAY ROADWAYS
PRIMARY & SECONDARY ROUTES
WORK ACTIVITY AREA
INTERSECTIONS with
INTERMEDIATE SPEED to HIGH SPEED
40 MPH - 60 MPH
MULTILANE ROADWAYS
- SHOULDER CLOSURES**
- DRAWING 515-01-A** - RIGHT SHOULDER CLOSURE
CASE I / CASE II
TWO-LANE TWO-WAY ROADWAYS
PRIMARY & SECONDARY ROUTES

MULTILANE SECONDARY AND PRIMARY ROADWAYS

Lane closures should be utilized for work activities that require equipment, personnel, materials, or any vehicles to encroach upon a travel lane or within 1 foot of a travel lane. When the work may be performed without the necessity for equipment, personnel, materials, or vehicles to encroach within 1 foot of an adjacent travel or without creating a hazard to passing motorists, utilize shoulder closures.

TYPICAL DRAWING APPLICATIONS

LANE CLOSURES

- | | | |
|-------------------------|---|--|
| DRAWING 505-01 | - | LANE CLOSURE
LOW SPEED MULTILANE
</= 35 MPH
PRIMARY & SECONDARY ROUTES |
| DRAWING 505-03-A | - | LANE CLOSURE
INTERMEDIATE SPEED TO HIGH SPEED
40 MPH - 60 MPH
MULTILANE
PRIMARY & SECONDARY ROUTES |

SHOULDER CLOSURES

- | | | |
|-------------------------|---|---|
| DRAWING 515-01-B | - | RIGHT SHOULDER CLOSURE
CASE I / CASE II
MULTILANE
PRIMARY & SECONDARY ROUTES |
| DRAWING 515-02 | - | LEFT SHOULDER CLOSURE
CASE I / CASE I
MULTILANE
PRIMARY & SECONDARY ROUTES |
| DRAWING 515-03 | - | LEFT SHOULDER CLOSURE
CASE I / CASE II
MULTILANE
PRIMARY & SECONDARY ROUTES |

INTERSTATE ROADWAYS

Utilize intermittent mobile operations for these work activities under the following conditions:

Condition 2 - The maximum time duration of a stop is 30 minutes if the vehicles remain in the shoulder areas in their entirety with no encroachment upon an adjacent travel lane.

During intermittent mobile operations, a shadow vehicle should be utilized when the stopping sight distance interval between the work vehicle or road machinery and an approaching motorist is unavailable based upon the posted regulatory speed limit of the work location.

Standard shoulder closures may be used for work activities that cannot be conducted under the conditions required for intermittent mobile operations.

Lane closures should be utilized for planned work activities that require equipment, personnel, materials, or any vehicles to encroach upon a travel lane or within 10 feet of a travel lane. When the work may be performed without the necessity for equipment, personnel, materials, or vehicles to encroach within 10 feet of an adjacent travel or without creating a hazard to passing motorists, utilize shoulder closures.

Lane closures should be utilized for work activities that cannot be conducted under the conditions required for intermittent mobile operations or standard shoulder closures.

TYPICAL DRAWING APPLICATIONS

LANE CLOSURES

- DRAWING 510-01-A** - LANE CLOSURE
INTERSTATE ROUTES
- DRAWING 510-01-B** - LANE CLOSURE
EXIT / ENTRANCE RAMPS
INTERSTATE ROUTES

SHOULDER CLOSURES

- DRAWING 520-01** - RIGHT SHOULDER CLOSURE
CASE I / CASE II
INTERSTATE ROUTES
- DRAWING 520-02** - LEFT SHOULDER CLOSURE
CASE I / CASE I
NARROW MEDIAN
INTERSTATE ROUTES
- DRAWING 520-03** - LEFT SHOULDER CLOSURE
CASE I / CASE I
WIDE MEDIAN
INTERSTATE ROUTES
- DRAWING 520-04** - LEFT SHOULDER CLOSURE
CASE I / CASE II
WIDE MEDIAN
INTERSTATE ROUTES
- DRAWING 520-05** - LEFT SHOULDER CLOSURE
CASE II / CASE II
WIDE MEDIAN
INTERSTATE ROUTES

MOBILE OPERATIONS – INTERMITTENT

- DRAWING 535-01-A** - MOBILE OPERATIONS – INTERMITTENT
STOPPING SIGHT DISTANCE
VEHICLE TRAIN REQUIREMENTS
VERTICAL CURVE (HILL)
- DRAWING 535-01-B** - MOBILE OPERATIONS – INTERMITTENT
STOPPING SIGHT DISTANCE
VEHICLE TRAIN REQUIREMENTS
HORIZONTAL CURVE (CURVE)
- DRAWING 535-04-D(1)** - MOBILE OPERATIONS – INTERMITTENT
HIGH VOLUME
HIGH SPEED
INTERSTATE ROUTES
- DRAWING 535-04-E** - MOBILE OPERATIONS – INTERMITTENT
HIGH VOLUME
HIGH SPEED
INTERIOR TRAVEL LANE OPERATIONS
INTERSTATE ROUTES

WORK DESCRIPTION 2 Spill Response

TRAFFIC CONTROL

CONDUCT THESE OPERATIONS PER DIRECTION OF THE DIRECTOR OF MAINTENANCE.

PERFORMANCE ACTIVITY 800

BRIDGE CONSTRUCTION

WORK DESCRIPTION 1
WORK DESCRIPTION 2

Rebuild Existing
Replace

800 BRIDGE CONSTRUCTION

ACTIVITY DESCRIPTION

Construct or reconstruct bridges.

WORK DESCRIPTION 1 Rebuild Existing

WORK DESCRIPTION 2 Replace

TRAFFIC CONTROL

TWO-LANE TWO-WAY ROADWAYS

Road closure and traffic detours are required for these work activities.

TYPICAL DRAWING APPLICATIONS

ROAD CLOSURE

DRAWING 705-02 - EXTENDED ROAD CLOSURE
FOR
BRIDGE WORK

DETOUR SIGNING

DRAWING 805-01 - DETOUR SIGNING
FOR
PRIMARY & INTERSTATE ROUTES

DRAWING 805-02 - DETOUR SIGNING
FOR
SECONDARY ROUTES

MULTILANE SECONDARY AND PRIMARY ROADWAYS

ROAD CLOSURE

DRAWING 705-02 - EXTENDED ROAD CLOSURE
FOR
BRIDGE WORK

DETOUR SIGNING

DRAWING 805-01 - DETOUR SIGNING
FOR
PRIMARY & INTERSTATE ROUTES

DRAWING 805-02 - DETOUR SIGNING
FOR
SECONDARY ROUTES

PERFORMANCE ACTIVITY 801

DECK REPAIR

WORK DESCRIPTION 1
WORK DESCRIPTION 2

Concrete Deck Repair
Non-Concrete Repair

801 DECK REPAIR

ACTIVITY DESCRIPTION

Repair spalled areas, replace deck panels, and repair timber bridge decks of roadway bridges.

WORK DESCRIPTION 1 Concrete Deck Repair

WORK DESCRIPTION 2 Non-Concrete Repair

TRAFFIC CONTROL

TWO-LANE TWO-WAY ROADWAYS

Flagging operations are required for work activities that require equipment, personnel, materials, or any vehicles to encroach upon a travel lane or a shoulder area of a bridge or a bridge approach.

Avoid locating a flagger station on a bridge or any portion of a bridge approach where an escape route is unavailable to the flagger in the advent of an errant vehicle.

When determined necessary, install and maintain road closures and traffic detours for these work activities.

TYPICAL DRAWING APPLICATIONS

FLAGGING OPERATIONS

- DRAWING 405-01-A** - FLAGGING OPERATIONS
MULTIPLE FLAGGERS
TWO-LANE TWO-WAY ROADWAYS
PRIMARY & SECONDARY ROUTES

- DRAWING 405-01-B(1)** - FLAGGING OPERATIONS
MULTIPLE FLAGGERS
TWO-LANE TWO-WAY ROADWAYS
PRIMARY & SECONDARY ROUTES
STOP SIGN CONTROLLED SIDE ROADS

- DRAWING 405-01-B(2)** - FLAGGING OPERATIONS
MULTIPLE FLAGGERS
TWO-LANE TWO-WAY ROADWAYS
PRIMARY & SECONDARY ROUTES
4-WAY STOP CONTROLLED INTERSECTION

- DRAWING 405-01-C(1)** - FLAGGING OPERATIONS
MULTIPLE FLAGGERS
TWO-LANE TWO-WAY ROADWAYS
PRIMARY & SECONDARY ROUTES
TRAFFIC SIGNAL CONTROLLED INTERSECTION
LAW ENFORCEMENT OFFICER(S)

- DRAWING 405-01-C(2)** - FLAGGING OPERATIONS
MULTIPLE FLAGGERS
TWO-LANE TWO-WAY ROADWAYS
PRIMARY & SECONDARY ROUTES
TRAFFIC SIGNAL CONTROLLED INTERSECTION
FLAGGERS

- DRAWING 405-01-D(1)** - FLAGGING OPERATIONS
MULTIPLE FLAGGERS
TWO-LANE TWO-WAY ROADWAYS
PRIMARY & SECONDARY ROUTES
WORK ACTIVITY AREA
BEGINNING at an
INTERSECTION with a
TWO-LANE TWO-WAY ROADWAY
DEPARTURE LANE

- DRAWING 405-01-D(2)** - FLAGGING OPERATIONS
MULTIPLE FLAGGERS
TWO-LANE TWO-WAY ROADWAYS
PRIMARY & SECONDARY ROUTES
WORK ACTIVITY AREA
TERMINATING at an
INTERSECTION with a
TWO-LANE TWO-WAY ROADWAY
APPROACH LANE
- DRAWING 405-01-E(1)**
DRAWING 405-01-E(2) - FLAGGING OPERATIONS
MULTIPLE FLAGGERS
TWO-LANE TWO-WAY ROADWAYS
PRIMARY & SECONDARY ROUTES
WORK ACTIVITY AREA
INTERSECTIONS with
LOW SPEED
< / = 35 MPH
MULTILANE ROADWAYS
- DRAWING 405-01-F(1)**
DRAWING 405-01-F(2) - FLAGGING OPERATIONS
MULTIPLE FLAGGERS
TWO-LANE TWO-WAY ROADWAYS
PRIMARY & SECONDARY ROUTES
WORK ACTIVITY AREA
INTERSECTIONS with
INTERMEDIATE SPEED to HIGH SPEED
40 MPH - 60 MPH
MULTILANE ROADWAYS
- DRAWING 405-02** - FLAGGING OPERATIONS
SINGLE FLAGGER OPERATION
LOW VOLUME
LOW SPEED TO INTERMEDIATE SPEED
TWO-LANE TWO-WAY ROADWAYS
PRIMARY & SECONDARY ROUTES

ROAD CLOSURE

- DRAWING 705-02** - EXTENDED ROAD CLOSURE
FOR
BRIDGE WORK

DETOUR SIGNING

- DRAWING 805-01** - DETOUR SIGNING
FOR
PRIMARY & INTERSTATE ROUTES
- DRAWING 805-02** - DETOUR SIGNING
FOR
SECONDARY ROUTES

MULTILANE SECONDARY AND PRIMARY ROADWAYS

Lane closures are required for work activities that require equipment, personnel, materials, or any vehicles to encroach upon a travel lane or a shoulder area of a bridge or a bridge approach.

When determined necessary, install and maintain road closures and traffic detours for these work activities.

TYPICAL DRAWING APPLICATIONS

LANE CLOSURES

- | | | |
|-------------------------|---|--|
| DRAWING 505-01 | - | LANE CLOSURE
LOW SPEED MULTILANE
< / = 35 MPH
PRIMARY & SECONDARY ROUTES |
| DRAWING 505-03-A | - | LANE CLOSURE
INTERMEDIATE SPEED TO HIGH SPEED
40 MPH - 60 MPH
MULTILANE
PRIMARY & SECONDARY ROUTES |

ROAD CLOSURE

- | | | |
|-----------------------|---|---|
| DRAWING 705-02 | - | EXTENDED ROAD CLOSURE
FOR
BRIDGE WORK |
|-----------------------|---|---|

DETOUR SIGNING

- | | | |
|-----------------------|---|--|
| DRAWING 805-01 | - | DETOUR SIGNING
FOR
PRIMARY & INTERSTATE ROUTES |
| DRAWING 805-02 | - | DETOUR SIGNING
FOR
SECONDARY ROUTES |

INTERSTATE ROADWAYS

Lane closures are required for work activities that require equipment, personnel, materials, or any vehicles to encroach upon a travel lane or a shoulder area of a bridge or a bridge approach.

TYPICAL DRAWING APPLICATIONS

LANE CLOSURES

- | | | |
|-------------------------|---|---|
| DRAWING 510-01-A | - | LANE CLOSURE
INTERSTATE ROUTES |
| DRAWING 510-01-B | - | LANE CLOSURE
EXIT / ENTRANCE RAMPS
INTERSTATE ROUTES |
| DRAWING 510-02-A | - | DUAL LANE CLOSURE
TRANSITION / ACTIVITY AREAS
INTERSTATE ROUTES |
| DRAWING 510-02-B | - | DUAL LANE CLOSURE
ADVANCE WARNING AREA
INTERSTATE ROUTES |
| DRAWING 510-02-C | - | DUAL LANE CLOSURE
EXIT / ENTRANCE RAMPS
INTERSTATE ROUTES |

PERFORMANCE ACTIVITY 802

BRIDGE RAIL REPAIR

802 BRIDGE RAIL REPAIR

ACTIVITY DESCRIPTION

Repair bridge rails and parapet walls due to accident damage and deterioration.

TRAFFIC CONTROL

TWO-LANE TWO-WAY ROADWAYS

Flagging operations are required for work activities that require equipment, personnel, materials, or any vehicles to encroach upon a travel lane or a shoulder area of a bridge or a bridge approach.

Avoid locating a flagger station on a bridge or any portion of a bridge approach where an escape route is unavailable to the flagger in the advent of an errant vehicle.

When determined necessary, install and maintain road closures and traffic detours for these work activities.

TYPICAL DRAWING APPLICATIONS

FLAGGING OPERATIONS

DRAWING 405-01-A	-	FLAGGING OPERATIONS MULTIPLE FLAGGERS TWO-LANE TWO-WAY ROADWAYS PRIMARY & SECONDARY ROUTES
DRAWING 405-01-B(1)	-	FLAGGING OPERATIONS MULTIPLE FLAGGERS TWO-LANE TWO-WAY ROADWAYS PRIMARY & SECONDARY ROUTES STOP SIGN CONTROLLED SIDE ROADS
DRAWING 405-01-B(2)	-	FLAGGING OPERATIONS MULTIPLE FLAGGERS TWO-LANE TWO-WAY ROADWAYS PRIMARY & SECONDARY ROUTES 4-WAY STOP CONTROLLED INTERSECTION
DRAWING 405-01-C(1)	-	FLAGGING OPERATIONS MULTIPLE FLAGGERS TWO-LANE TWO-WAY ROADWAYS PRIMARY & SECONDARY ROUTES TRAFFIC SIGNAL CONTROLLED INTERSECTION LAW ENFORCEMENT OFFICER(S)
DRAWING 405-01-C(2)	-	FLAGGING OPERATIONS MULTIPLE FLAGGERS TWO-LANE TWO-WAY ROADWAYS PRIMARY & SECONDARY ROUTES TRAFFIC SIGNAL CONTROLLED INTERSECTION FLAGGERS
DRAWING 405-01-D(1)	-	FLAGGING OPERATIONS MULTIPLE FLAGGERS TWO-LANE TWO-WAY ROADWAYS PRIMARY & SECONDARY ROUTES WORK ACTIVITY AREA BEGINNING at an INTERSECTION with a TWO-LANE TWO-WAY ROADWAY DEPARTURE LANE

- DRAWING 405-01-D(2)** - FLAGGING OPERATIONS
MULTIPLE FLAGGERS
TWO-LANE TWO-WAY ROADWAYS
PRIMARY & SECONDARY ROUTES
WORK ACTIVITY AREA
TERMINATING at an
INTERSECTION with a
TWO-LANE TWO-WAY ROADWAY
APPROACH LANE
- DRAWING 405-01-E(1)**
DRAWING 405-01-E(2) - FLAGGING OPERATIONS
MULTIPLE FLAGGERS
TWO-LANE TWO-WAY ROADWAYS
PRIMARY & SECONDARY ROUTES
WORK ACTIVITY AREA
INTERSECTIONS with
LOW SPEED
< / = 35 MPH
MULTILANE ROADWAYS
- DRAWING 405-01-F(1)**
DRAWING 405-01-F(2) - FLAGGING OPERATIONS
MULTIPLE FLAGGERS
TWO-LANE TWO-WAY ROADWAYS
PRIMARY & SECONDARY ROUTES
WORK ACTIVITY AREA
INTERSECTIONS with
INTERMEDIATE SPEED to HIGH SPEED
40 MPH - 60 MPH
MULTILANE ROADWAYS
- DRAWING 405-02** - FLAGGING OPERATIONS
SINGLE FLAGGER OPERATION
LOW VOLUME
LOW SPEED TO INTERMEDIATE SPEED
TWO-LANE TWO-WAY ROADWAYS
PRIMARY & SECONDARY ROUTES

ROAD CLOSURE

- DRAWING 705-02** - EXTENDED ROAD CLOSURE
FOR
BRIDGE WORK

DETOUR SIGNING

- DRAWING 805-01** - DETOUR SIGNING
FOR
PRIMARY & INTERSTATE ROUTES
- DRAWING 805-02** - DETOUR SIGNING
FOR
SECONDARY ROUTES

MULTILANE SECONDARY AND PRIMARY ROADWAYS

Lane closures are required for work activities that require equipment, personnel, materials, or any vehicles to encroach upon a travel lane or a shoulder area of a bridge or a bridge approach.

When determined necessary, install and maintain road closures and traffic detours for these work activities.

TYPICAL DRAWING APPLICATIONS

LANE CLOSURES

- | | | |
|-------------------------|---|--|
| DRAWING 505-01 | - | LANE CLOSURE
LOW SPEED MULTILANE
< / = 35 MPH
PRIMARY & SECONDARY ROUTES |
| DRAWING 505-03-A | - | LANE CLOSURE
INTERMEDIATE SPEED TO HIGH SPEED
40 MPH - 60 MPH
MULTILANE
PRIMARY & SECONDARY ROUTES |

ROAD CLOSURE

- | | | |
|-----------------------|---|---|
| DRAWING 705-02 | - | EXTENDED ROAD CLOSURE
FOR
BRIDGE WORK |
|-----------------------|---|---|

DETOUR SIGNING

- | | | |
|-----------------------|---|--|
| DRAWING 805-01 | - | DETOUR SIGNING
FOR
PRIMARY & INTERSTATE ROUTES |
| DRAWING 805-02 | - | DETOUR SIGNING
FOR
SECONDARY ROUTES |

INTERSTATE ROADWAYS

Lane closures are required for work activities that require equipment, personnel, materials, or any vehicles to encroach upon a travel lane or a shoulder area of a bridge or a bridge approach.

TYPICAL DRAWING APPLICATIONS

LANE CLOSURES

- | | | |
|-------------------------|---|---|
| DRAWING 510-01-A | - | LANE CLOSURE
INTERSTATE ROUTES |
| DRAWING 510-01-B | - | LANE CLOSURE
EXIT / ENTRANCE RAMPS
INTERSTATE ROUTES |
| DRAWING 510-02-A | - | DUAL LANE CLOSURE
TRANSITION / ACTIVITY AREAS
INTERSTATE ROUTES |
| DRAWING 510-02-B | - | DUAL LANE CLOSURE
ADVANCE WARNING AREA
INTERSTATE ROUTES |
| DRAWING 510-02-C | - | DUAL LANE CLOSURE
EXIT / ENTRANCE RAMPS
INTERSTATE ROUTES |

PERFORMANCE ACTIVITY 803

SUPERSTRUCTURE ELEMENT

WORK DESCRIPTION 1	Beams
WORK DESCRIPTION 2	Floor Beams
WORK DESCRIPTION 3	Stringers
WORK DESCRIPTION 4	Truss Chords

803 SUPERSTRUCTURE ELEMENT

ACTIVITY DESCRIPTION

Repair or replace bridge superstructure elements due to deterioration or accident damage.

WORK DESCRIPTION 1 Beams
WORK DESCRIPTION 2 Floor Beams
WORK DESCRIPTION 3 Stringers
WORK DESCRIPTION 4 Truss Chords

TRAFFIC CONTROL

TWO-LANE TWO-WAY ROADWAYS

Flagging operations are required for work activities that require equipment, personnel, materials, or any vehicles to encroach upon a travel lane or a shoulder area of a bridge or a bridge approach.

Avoid locating a flagger station on a bridge or any portion of a bridge approach where an escape route is unavailable to the flagger in the advent of an errant vehicle.

When determined necessary, install and maintain road closures and traffic detours for these work activities.

TYPICAL DRAWING APPLICATIONS

FLAGGING OPERATIONS

DRAWING 405-01-A	-	FLAGGING OPERATIONS MULTIPLE FLAGGERS TWO-LANE TWO-WAY ROADWAYS PRIMARY & SECONDARY ROUTES
DRAWING 405-01-B(1)	-	FLAGGING OPERATIONS MULTIPLE FLAGGERS TWO-LANE TWO-WAY ROADWAYS PRIMARY & SECONDARY ROUTES STOP SIGN CONTROLLED SIDE ROADS
DRAWING 405-01-B(2)	-	FLAGGING OPERATIONS MULTIPLE FLAGGERS TWO-LANE TWO-WAY ROADWAYS PRIMARY & SECONDARY ROUTES 4-WAY STOP CONTROLLED INTERSECTION
DRAWING 405-01-C(1)	-	FLAGGING OPERATIONS MULTIPLE FLAGGERS TWO-LANE TWO-WAY ROADWAYS PRIMARY & SECONDARY ROUTES TRAFFIC SIGNAL CONTROLLED INTERSECTION LAW ENFORCEMENT OFFICER(S)
DRAWING 405-01-C(2)	-	FLAGGING OPERATIONS MULTIPLE FLAGGERS TWO-LANE TWO-WAY ROADWAYS PRIMARY & SECONDARY ROUTES TRAFFIC SIGNAL CONTROLLED INTERSECTION FLAGGERS

- DRAWING 405-01-D(1)** - FLAGGING OPERATIONS
MULTIPLE FLAGGERS
TWO-LANE TWO-WAY ROADWAYS
PRIMARY & SECONDARY ROUTES
WORK ACTIVITY AREA
BEGINNING at an
INTERSECTION with a
TWO-LANE TWO-WAY ROADWAY
DEPARTURE LANE
- DRAWING 405-01-D(2)** - FLAGGING OPERATIONS
MULTIPLE FLAGGERS
TWO-LANE TWO-WAY ROADWAYS
PRIMARY & SECONDARY ROUTES
WORK ACTIVITY AREA
TERMINATING at an
INTERSECTION with a
TWO-LANE TWO-WAY ROADWAY
APPROACH LANE
- DRAWING 405-01-E(1)**
DRAWING 405-01-E(2) - FLAGGING OPERATIONS
MULTIPLE FLAGGERS
TWO-LANE TWO-WAY ROADWAYS
PRIMARY & SECONDARY ROUTES
WORK ACTIVITY AREA
INTERSECTIONS with
LOW SPEED
< / = 35 MPH
MULTILANE ROADWAYS
- DRAWING 405-01-F(1)**
DRAWING 405-01-F(2) - FLAGGING OPERATIONS
MULTIPLE FLAGGERS
TWO-LANE TWO-WAY ROADWAYS
PRIMARY & SECONDARY ROUTES
WORK ACTIVITY AREA
INTERSECTIONS with
INTERMEDIATE SPEED to HIGH SPEED
40 MPH - 60 MPH
MULTILANE ROADWAYS
- DRAWING 405-02** - FLAGGING OPERATIONS
SINGLE FLAGGER OPERATION
LOW VOLUME
LOW SPEED TO INTERMEDIATE SPEED
TWO-LANE TWO-WAY ROADWAYS
PRIMARY & SECONDARY ROUTES

ROAD CLOSURE

- DRAWING 705-02** - EXTENDED ROAD CLOSURE
FOR
BRIDGE WORK

DETOUR SIGNING

- DRAWING 805-01** - DETOUR SIGNING
FOR
PRIMARY & INTERSTATE ROUTES
- DRAWING 805-02** - DETOUR SIGNING
FOR
SECONDARY ROUTES

MULTILANE SECONDARY AND PRIMARY ROADWAYS

Lane closures are required for work activities that require equipment, personnel, materials, or any vehicles to encroach upon a travel lane or a shoulder area of a bridge or a bridge approach.

When determined necessary, install and maintain road closures and traffic detours for these work activities.

TYPICAL DRAWING APPLICATIONS

LANE CLOSURES

- | | | |
|-------------------------|---|--|
| DRAWING 505-01 | - | LANE CLOSURE
LOW SPEED MULTILANE
< / = 35 MPH
PRIMARY & SECONDARY ROUTES |
| DRAWING 505-03-A | - | LANE CLOSURE
INTERMEDIATE SPEED TO HIGH SPEED
40 MPH - 60 MPH
MULTILANE
PRIMARY & SECONDARY ROUTES |

ROAD CLOSURE

- | | | |
|-----------------------|---|---|
| DRAWING 705-02 | - | EXTENDED ROAD CLOSURE
FOR
BRIDGE WORK |
|-----------------------|---|---|

DETOUR SIGNING

- | | | |
|-----------------------|---|--|
| DRAWING 805-01 | - | DETOUR SIGNING
FOR
PRIMARY & INTERSTATE ROUTES |
| DRAWING 805-02 | - | DETOUR SIGNING
FOR
SECONDARY ROUTES |

INTERSTATE ROADWAYS

Lane closures are required for work activities that require equipment, personnel, materials, or any vehicles to encroach upon a travel lane or a shoulder area of a bridge or a bridge approach.

TYPICAL DRAWING APPLICATIONS

LANE CLOSURES

- | | | |
|-------------------------|---|---|
| DRAWING 510-01-A | - | LANE CLOSURE
INTERSTATE ROUTES |
| DRAWING 510-01-B | - | LANE CLOSURE
EXIT / ENTRANCE RAMPS
INTERSTATE ROUTES |
| DRAWING 510-02-A | - | DUAL LANE CLOSURE
TRANSITION / ACTIVITY AREAS
INTERSTATE ROUTES |
| DRAWING 510-02-B | - | DUAL LANE CLOSURE
ADVANCE WARNING AREA
INTERSTATE ROUTES |
| DRAWING 510-02-C | - | DUAL LANE CLOSURE
EXIT / ENTRANCE RAMPS
INTERSTATE ROUTES |

PERFORMANCE ACTIVITY 805

BRIDGE EXPANSION JOINTS

WORK DESCRIPTION 1
WORK DESCRIPTION 2

Compression Seal
Cold-Poured Seal

805 BRIDGE EXPANSION JOINTS

ACTIVITY DESCRIPTION

Remove old joint material and clean and install new joint material.

WORK DESCRIPTION 1 Compression Seal

WORK DESCRIPTION 2 Cold-Poured Seal

TRAFFIC CONTROL

TWO-LANE TWO-WAY ROADWAYS

Flagging operations are required for work activities that require equipment, personnel, materials, or any vehicles to encroach upon a travel lane or a shoulder area of a bridge or a bridge approach.

Avoid locating a flagger station on a bridge or any portion of a bridge approach where an escape route is unavailable to the flagger in the advent of an errant vehicle.

When determined necessary, install and maintain road closures and traffic detours for these work activities.

TYPICAL DRAWING APPLICATIONS

FLAGGING OPERATIONS

DRAWING 405-01-A	-	FLAGGING OPERATIONS MULTIPLE FLAGGERS TWO-LANE TWO-WAY ROADWAYS PRIMARY & SECONDARY ROUTES
DRAWING 405-01-B(1)	-	FLAGGING OPERATIONS MULTIPLE FLAGGERS TWO-LANE TWO-WAY ROADWAYS PRIMARY & SECONDARY ROUTES STOP SIGN CONTROLLED SIDE ROADS
DRAWING 405-01-B(2)	-	FLAGGING OPERATIONS MULTIPLE FLAGGERS TWO-LANE TWO-WAY ROADWAYS PRIMARY & SECONDARY ROUTES 4-WAY STOP CONTROLLED INTERSECTION
DRAWING 405-01-C(1)	-	FLAGGING OPERATIONS MULTIPLE FLAGGERS TWO-LANE TWO-WAY ROADWAYS PRIMARY & SECONDARY ROUTES TRAFFIC SIGNAL CONTROLLED INTERSECTION LAW ENFORCEMENT OFFICER(S)
DRAWING 405-01-C(2)	-	FLAGGING OPERATIONS MULTIPLE FLAGGERS TWO-LANE TWO-WAY ROADWAYS PRIMARY & SECONDARY ROUTES TRAFFIC SIGNAL CONTROLLED INTERSECTION FLAGGERS
DRAWING 405-01-D(1)	-	FLAGGING OPERATIONS MULTIPLE FLAGGERS TWO-LANE TWO-WAY ROADWAYS PRIMARY & SECONDARY ROUTES WORK ACTIVITY AREA BEGINNING at an INTERSECTION with a TWO-LANE TWO-WAY ROADWAY DEPARTURE LANE

- DRAWING 405-01-D(2)** - FLAGGING OPERATIONS
MULTIPLE FLAGGERS
TWO-LANE TWO-WAY ROADWAYS
PRIMARY & SECONDARY ROUTES
WORK ACTIVITY AREA
TERMINATING at an
INTERSECTION with a
TWO-LANE TWO-WAY ROADWAY
APPROACH LANE
- DRAWING 405-01-E(1)**
DRAWING 405-01-E(2) - FLAGGING OPERATIONS
MULTIPLE FLAGGERS
TWO-LANE TWO-WAY ROADWAYS
PRIMARY & SECONDARY ROUTES
WORK ACTIVITY AREA
INTERSECTIONS with
LOW SPEED
< / = 35 MPH
MULTILANE ROADWAYS
- DRAWING 405-01-F(1)**
DRAWING 405-01-F(2) - FLAGGING OPERATIONS
MULTIPLE FLAGGERS
TWO-LANE TWO-WAY ROADWAYS
PRIMARY & SECONDARY ROUTES
WORK ACTIVITY AREA
INTERSECTIONS with
INTERMEDIATE SPEED to HIGH SPEED
40 MPH - 60 MPH
MULTILANE ROADWAYS
- DRAWING 405-02** - FLAGGING OPERATIONS
SINGLE FLAGGER OPERATION
LOW VOLUME
LOW SPEED TO INTERMEDIATE SPEED
TWO-LANE TWO-WAY ROADWAYS
PRIMARY & SECONDARY ROUTES

ROAD CLOSURE

- DRAWING 705-02** - EXTENDED ROAD CLOSURE
FOR
BRIDGE WORK

DETOUR SIGNING

- DRAWING 805-01** - DETOUR SIGNING
FOR
PRIMARY & INTERSTATE ROUTES
- DRAWING 805-02** - DETOUR SIGNING
FOR
SECONDARY ROUTES

MULTILANE SECONDARY AND PRIMARY ROADWAYS

Lane closures are required for work activities that require equipment, personnel, materials, or any vehicles to encroach upon a travel lane or a shoulder area of a bridge or a bridge approach.

When determined necessary, install and maintain road closures and traffic detours for these work activities.

TYPICAL DRAWING APPLICATIONS

LANE CLOSURES

- | | | |
|-------------------------|---|--|
| DRAWING 505-01 | - | LANE CLOSURE
LOW SPEED MULTILANE
< / = 35 MPH
PRIMARY & SECONDARY ROUTES |
| DRAWING 505-03-A | - | LANE CLOSURE
INTERMEDIATE SPEED TO HIGH SPEED
40 MPH - 60 MPH
MULTILANE
PRIMARY & SECONDARY ROUTES |

ROAD CLOSURE

- | | | |
|-----------------------|---|---|
| DRAWING 705-02 | - | EXTENDED ROAD CLOSURE
FOR
BRIDGE WORK |
|-----------------------|---|---|

DETOUR SIGNING

- | | | |
|-----------------------|---|--|
| DRAWING 805-01 | - | DETOUR SIGNING
FOR
PRIMARY & INTERSTATE ROUTES |
| DRAWING 805-02 | - | DETOUR SIGNING
FOR
SECONDARY ROUTES |

INTERSTATE ROADWAYS

Lane closures are required for work activities that require equipment, personnel, materials, or any vehicles to encroach upon a travel lane or a shoulder area of a bridge or a bridge approach.

TYPICAL DRAWING APPLICATIONS

LANE CLOSURES

- | | | |
|-------------------------|---|---|
| DRAWING 510-01-A | - | LANE CLOSURE
INTERSTATE ROUTES |
| DRAWING 510-01-B | - | LANE CLOSURE
EXIT / ENTRANCE RAMPS
INTERSTATE ROUTES |
| DRAWING 510-02-A | - | DUAL LANE CLOSURE
TRANSITION / ACTIVITY AREAS
INTERSTATE ROUTES |
| DRAWING 510-02-B | - | DUAL LANE CLOSURE
ADVANCE WARNING AREA
INTERSTATE ROUTES |
| DRAWING 510-02-C | - | DUAL LANE CLOSURE
EXIT / ENTRANCE RAMPS
INTERSTATE ROUTES |

PERFORMANCE ACTIVITY 806

BEARING AND SADDLES

WORK DESCRIPTION 1	Repair Elastomeric Bearing
WORK DESCRIPTION 2	Replace Elastomeric Bearing
WORK DESCRIPTION 3	Repair Steel Bearing Assembly
WORK DESCRIPTION 4	Replace Steel Bearing Assembly
WORK DESCRIPTION 5	Steel Saddle - Individual
WORK DESCRIPTION 6	Steel Saddle - Continuous

806 BEARING AND SADDLES

ACTIVITY DESCRIPTION

Repair or replace steel and elastomeric bearing assemblies and place saddles.

- WORK DESCRIPTION 1** Repair Elastomeric Bearing
- WORK DESCRIPTION 2** Replace Elastomeric Bearing
- WORK DESCRIPTION 3** Repair Steel Bearing Assembly
- WORK DESCRIPTION 4** Replace Steel Bearing Assembly
- WORK DESCRIPTION 5** Steel Saddle - Individual
- WORK DESCRIPTION 6** Steel Saddle - Continuous

TRAFFIC CONTROL

TWO-LANE TWO-WAY ROADWAYS

Flagging operations are required for work activities that require equipment, personnel, materials, or any vehicles to encroach upon a travel lane or a shoulder area of a bridge or a bridge approach.

Avoid locating a flagger station on a bridge or any portion of a bridge approach where an escape route is unavailable to the flagger in the advent of an errant vehicle.

When determined necessary, install and maintain road closures and traffic detours for these work activities.

TYPICAL DRAWING APPLICATIONS

FLAGGING OPERATIONS

- | | | |
|----------------------------|---|---|
| DRAWING 405-01-A | - | FLAGGING OPERATIONS
MULTIPLE FLAGGERS
TWO-LANE TWO-WAY ROADWAYS
PRIMARY & SECONDARY ROUTES |
| DRAWING 405-01-B(1) | - | FLAGGING OPERATIONS
MULTIPLE FLAGGERS
TWO-LANE TWO-WAY ROADWAYS
PRIMARY & SECONDARY ROUTES
STOP SIGN CONTROLLED SIDE ROADS |
| DRAWING 405-01-B(2) | - | FLAGGING OPERATIONS
MULTIPLE FLAGGERS
TWO-LANE TWO-WAY ROADWAYS
PRIMARY & SECONDARY ROUTES
4-WAY STOP CONTROLLED INTERSECTION |
| DRAWING 405-01-C(1) | - | FLAGGING OPERATIONS
MULTIPLE FLAGGERS
TWO-LANE TWO-WAY ROADWAYS
PRIMARY & SECONDARY ROUTES
TRAFFIC SIGNAL CONTROLLED INTERSECTION
LAW ENFORCEMENT OFFICER(S) |
| DRAWING 405-01-C(2) | - | FLAGGING OPERATIONS
MULTIPLE FLAGGERS
TWO-LANE TWO-WAY ROADWAYS
PRIMARY & SECONDARY ROUTES
TRAFFIC SIGNAL CONTROLLED INTERSECTION
FLAGGERS |

- DRAWING 405-01-D(1)** - FLAGGING OPERATIONS
 MULTIPLE FLAGGERS
 TWO-LANE TWO-WAY ROADWAYS
 PRIMARY & SECONDARY ROUTES
 WORK ACTIVITY AREA
 BEGINNING at an
 INTERSECTION with a
 TWO-LANE TWO-WAY ROADWAY
 DEPARTURE LANE
- DRAWING 405-01-D(2)** - FLAGGING OPERATIONS
 MULTIPLE FLAGGERS
 TWO-LANE TWO-WAY ROADWAYS
 PRIMARY & SECONDARY ROUTES
 WORK ACTIVITY AREA
 TERMINATING at an
 INTERSECTION with a
 TWO-LANE TWO-WAY ROADWAY
 APPROACH LANE
- DRAWING 405-01-E(1)**
DRAWING 405-01-E(2) - FLAGGING OPERATIONS
 MULTIPLE FLAGGERS
 TWO-LANE TWO-WAY ROADWAYS
 PRIMARY & SECONDARY ROUTES
 WORK ACTIVITY AREA
 INTERSECTIONS with
 LOW SPEED
 < / = 35 MPH
 MULTILANE ROADWAYS
- DRAWING 405-01-F(1)**
DRAWING 405-01-F(2) - FLAGGING OPERATIONS
 MULTIPLE FLAGGERS
 TWO-LANE TWO-WAY ROADWAYS
 PRIMARY & SECONDARY ROUTES
 WORK ACTIVITY AREA
 INTERSECTIONS with
 INTERMEDIATE SPEED to HIGH SPEED
 40 MPH - 60 MPH
 MULTILANE ROADWAYS
- DRAWING 405-02** - FLAGGING OPERATIONS
 SINGLE FLAGGER OPERATION
 LOW VOLUME
 LOW SPEED TO INTERMEDIATE SPEED
 TWO-LANE TWO-WAY ROADWAYS
 PRIMARY & SECONDARY ROUTES

ROAD CLOSURE

- DRAWING 705-02** - EXTENDED ROAD CLOSURE
 FOR
 BRIDGE WORK

DETOUR SIGNING

- DRAWING 805-01** - DETOUR SIGNING
 FOR
 PRIMARY & INTERSTATE ROUTES
- DRAWING 805-02** - DETOUR SIGNING
 FOR
 SECONDARY ROUTES

MULTILANE SECONDARY AND PRIMARY ROADWAYS

Lane closures are required for work activities that require equipment, personnel, materials, or any vehicles to encroach upon a travel lane or a shoulder area of a bridge or a bridge approach.

When determined necessary, install and maintain road closures and traffic detours for these work activities.

TYPICAL DRAWING APPLICATIONS

LANE CLOSURES

- | | | |
|-------------------------|---|--|
| DRAWING 505-01 | - | LANE CLOSURE
LOW SPEED MULTILANE
< / = 35 MPH
PRIMARY & SECONDARY ROUTES |
| DRAWING 505-03-A | - | LANE CLOSURE
INTERMEDIATE SPEED TO HIGH SPEED
40 MPH - 60 MPH
MULTILANE
PRIMARY & SECONDARY ROUTES |

ROAD CLOSURE

- | | | |
|-----------------------|---|---|
| DRAWING 705-02 | - | EXTENDED ROAD CLOSURE
FOR
BRIDGE WORK |
|-----------------------|---|---|

DETOUR SIGNING

- | | | |
|-----------------------|---|--|
| DRAWING 805-01 | - | DETOUR SIGNING
FOR
PRIMARY & INTERSTATE ROUTES |
| DRAWING 805-02 | - | DETOUR SIGNING
FOR
SECONDARY ROUTES |

INTERSTATE ROADWAYS

Lane closures are required for work activities that require equipment, personnel, materials, or any vehicles to encroach upon a travel lane or a shoulder area of a bridge or a bridge approach.

TYPICAL DRAWING APPLICATIONS

LANE CLOSURES

- | | | |
|-------------------------|---|---|
| DRAWING 510-01-A | - | LANE CLOSURE
INTERSTATE ROUTES |
| DRAWING 510-01-B | - | LANE CLOSURE
EXIT / ENTRANCE RAMPS
INTERSTATE ROUTES |
| DRAWING 510-02-A | - | DUAL LANE CLOSURE
TRANSITION / ACTIVITY AREAS
INTERSTATE ROUTES |
| DRAWING 510-02-B | - | DUAL LANE CLOSURE
ADVANCE WARNING AREA
INTERSTATE ROUTES |
| DRAWING 510-02-C | - | DUAL LANE CLOSURE
EXIT / ENTRANCE RAMPS
INTERSTATE ROUTES |

PERFORMANCE ACTIVITY 807

BRIDGE MAINTENANCE

WORK DESCRIPTION 1	Debris Removal
WORK DESCRIPTION 2	Electrical Repair / Inspection
WORK DESCRIPTION 3	Mechanical Repair
WORK DESCRIPTION 4	Scour Remediation
WORK DESCRIPTION 5	Clean Weep Holes
WORK DESCRIPTION 6	Clean Bearing Assemblies / Caps
WORK DESCRIPTION 7	Fender Repair

807 BRIDGE MAINTENANCE

ACTIVITY DESCRIPTION

Maintain and repair roadway bridges.

WORK DESCRIPTION 1 Debris Removal
WORK DESCRIPTION 2 Electrical Repair / Inspection
WORK DESCRIPTION 3 Mechanical Repair
WORK DESCRIPTION 4 Scour Remediation
WORK DESCRIPTION 5 Clean Weep Holes
WORK DESCRIPTION 6 Clean Bearing Assemblies / Caps
WORK DESCRIPTION 7 Fender Repair

TRAFFIC CONTROL

TWO-LANE TWO-WAY ROADWAYS

Flagging operations are required for work activities that require equipment, personnel, materials, or any vehicles to encroach upon a travel lane or a shoulder area of a bridge or a bridge approach.

Avoid locating a flagger station on a bridge or any portion of a bridge approach where an escape route is unavailable to the flagger in the advent of an errant vehicle.

When determined necessary, install and maintain road closures and traffic detours for these work activities.

TYPICAL DRAWING APPLICATIONS

FLAGGING OPERATIONS

DRAWING 405-01-A	-	FLAGGING OPERATIONS MULTIPLE FLAGGERS TWO-LANE TWO-WAY ROADWAYS PRIMARY & SECONDARY ROUTES
DRAWING 405-01-B(1)	-	FLAGGING OPERATIONS MULTIPLE FLAGGERS TWO-LANE TWO-WAY ROADWAYS PRIMARY & SECONDARY ROUTES STOP SIGN CONTROLLED SIDE ROADS
DRAWING 405-01-B(2)	-	FLAGGING OPERATIONS MULTIPLE FLAGGERS TWO-LANE TWO-WAY ROADWAYS PRIMARY & SECONDARY ROUTES 4-WAY STOP CONTROLLED INTERSECTION
DRAWING 405-01-C(1)	-	FLAGGING OPERATIONS MULTIPLE FLAGGERS TWO-LANE TWO-WAY ROADWAYS PRIMARY & SECONDARY ROUTES TRAFFIC SIGNAL CONTROLLED INTERSECTION LAW ENFORCEMENT OFFICER(S)
DRAWING 405-01-C(2)	-	FLAGGING OPERATIONS MULTIPLE FLAGGERS TWO-LANE TWO-WAY ROADWAYS PRIMARY & SECONDARY ROUTES TRAFFIC SIGNAL CONTROLLED INTERSECTION FLAGGERS

- DRAWING 405-01-D(1) - FLAGGING OPERATIONS
MULTIPLE FLAGGERS
TWO-LANE TWO-WAY ROADWAYS
PRIMARY & SECONDARY ROUTES
WORK ACTIVITY AREA
BEGINNING at an
INTERSECTION with a
TWO-LANE TWO-WAY ROADWAY
DEPARTURE LANE
- DRAWING 405-01-D(2) - FLAGGING OPERATIONS
MULTIPLE FLAGGERS
TWO-LANE TWO-WAY ROADWAYS
PRIMARY & SECONDARY ROUTES
WORK ACTIVITY AREA
TERMINATING at an
INTERSECTION with a
TWO-LANE TWO-WAY ROADWAY
APPROACH LANE
- DRAWING 405-01-E(1)
DRAWING 405-01-E(2) - FLAGGING OPERATIONS
MULTIPLE FLAGGERS
TWO-LANE TWO-WAY ROADWAYS
PRIMARY & SECONDARY ROUTES
WORK ACTIVITY AREA
INTERSECTIONS with
LOW SPEED
< / = 35 MPH
MULTILANE ROADWAYS
- DRAWING 405-01-F(1)
DRAWING 405-01-F(2) - FLAGGING OPERATIONS
MULTIPLE FLAGGERS
TWO-LANE TWO-WAY ROADWAYS
PRIMARY & SECONDARY ROUTES
WORK ACTIVITY AREA
INTERSECTIONS with
INTERMEDIATE SPEED to HIGH SPEED
40 MPH - 60 MPH
MULTILANE ROADWAYS
- DRAWING 405-02 - FLAGGING OPERATIONS
SINGLE FLAGGER OPERATION
LOW VOLUME
LOW SPEED TO INTERMEDIATE SPEED
TWO-LANE TWO-WAY ROADWAYS
PRIMARY & SECONDARY ROUTES

ROAD CLOSURE

- DRAWING 705-02 - EXTENDED ROAD CLOSURE
FOR
BRIDGE WORK

DETOUR SIGNING

- DRAWING 805-01 - DETOUR SIGNING
FOR
PRIMARY & INTERSTATE ROUTES
- DRAWING 805-02 - DETOUR SIGNING
FOR
SECONDARY ROUTES

MULTILANE SECONDARY AND PRIMARY ROADWAYS

Lane closures are required for work activities that require equipment, personnel, materials, or any vehicles to encroach upon a travel lane or a shoulder area of a bridge or a bridge approach.

When determined necessary, install and maintain road closures and traffic detours for these work activities.

TYPICAL DRAWING APPLICATIONS

LANE CLOSURES

- | | | |
|------------------|---|--|
| DRAWING 505-01 | - | LANE CLOSURE
LOW SPEED MULTILANE
< / = 35 MPH
PRIMARY & SECONDARY ROUTES |
| DRAWING 505-03-A | - | LANE CLOSURE
INTERMEDIATE SPEED TO HIGH SPEED
40 MPH - 60 MPH
MULTILANE
PRIMARY & SECONDARY ROUTES |

ROAD CLOSURE

- | | | |
|----------------|---|---|
| DRAWING 705-02 | - | EXTENDED ROAD CLOSURE
FOR
BRIDGE WORK |
|----------------|---|---|

DETOUR SIGNING

- | | | |
|----------------|---|--|
| DRAWING 805-01 | - | DETOUR SIGNING
FOR
PRIMARY & INTERSTATE ROUTES |
| DRAWING 805-02 | - | DETOUR SIGNING
FOR
SECONDARY ROUTES |

INTERSTATE ROADWAYS

Lane closures are required for work activities that require equipment, personnel, materials, or any vehicles to encroach upon a travel lane or a shoulder area of a bridge or a bridge approach.

TYPICAL DRAWING APPLICATIONS

LANE CLOSURES

- | | | |
|-------------------------|---|---|
| DRAWING 510-01-A | - | LANE CLOSURE
INTERSTATE ROUTES |
| DRAWING 510-01-B | - | LANE CLOSURE
EXIT / ENTRANCE RAMPS
INTERSTATE ROUTES |
| DRAWING 510-02-A | - | DUAL LANE CLOSURE
TRANSITION / ACTIVITY AREAS
INTERSTATE ROUTES |
| DRAWING 510-02-B | - | DUAL LANE CLOSURE
ADVANCE WARNING AREA
INTERSTATE ROUTES |
| DRAWING 510-02-C | - | DUAL LANE CLOSURE
EXIT / ENTRANCE RAMPS
INTERSTATE ROUTES |

MOBILIZED SHOULDER OPERATIONS

- | | | |
|-----------------------|---|---|
| DRAWING 530-03 | - | MOBILIZED SHOULDER OPERATIONS
PEDESTRIAN WORKERS – MAJOR ENCROACHMENT
UPON PAVED SHOULDER
ROAD MACHINERY – MAJOR ENCROACHMENT
UPON TRAVEL LANE
INTERSTATE ROUTES |
|-----------------------|---|---|

PERFORMANCE ACTIVITY 809

BRIDGE PILES AND CAPS

WORK DESCRIPTION 1	Cap Repair
WORK DESCRIPTION 2	Cap Replacement
WORK DESCRIPTION 3	Pile Repair
WORK DESCRIPTION 4	Pile Replacement

809 BRIDGE PILES AND CAPS

ACTIVITY DESCRIPTION

Repair or replace concrete, steel or timber piles and caps.

WORK DESCRIPTION 1 Cap Repair
WORK DESCRIPTION 2 Cap Replacement
WORK DESCRIPTION 3 Pile Repair
WORK DESCRIPTION 4 Pile Replacement

TRAFFIC CONTROL

TWO-LANE TWO-WAY ROADWAYS

Flagging operations are required for work activities that require equipment, personnel, materials, or any vehicles to encroach upon a travel lane or a shoulder area of a bridge or a bridge approach.

Avoid locating a flagger station on a bridge or any portion of a bridge approach where an escape route is unavailable to the flagger in the advent of an errant vehicle.

When determined necessary, install and maintain road closures and traffic detours for these work activities.

TYPICAL DRAWING APPLICATIONS

FLAGGING OPERATIONS

DRAWING 405-01-A	-	FLAGGING OPERATIONS MULTIPLE FLAGGERS TWO-LANE TWO-WAY ROADWAYS PRIMARY & SECONDARY ROUTES
DRAWING 405-01-B(1)	-	FLAGGING OPERATIONS MULTIPLE FLAGGERS TWO-LANE TWO-WAY ROADWAYS PRIMARY & SECONDARY ROUTES STOP SIGN CONTROLLED SIDE ROADS
DRAWING 405-01-B(2)	-	FLAGGING OPERATIONS MULTIPLE FLAGGERS TWO-LANE TWO-WAY ROADWAYS PRIMARY & SECONDARY ROUTES 4-WAY STOP CONTROLLED INTERSECTION
DRAWING 405-01-C(1)	-	FLAGGING OPERATIONS MULTIPLE FLAGGERS TWO-LANE TWO-WAY ROADWAYS PRIMARY & SECONDARY ROUTES TRAFFIC SIGNAL CONTROLLED INTERSECTION LAW ENFORCEMENT OFFICER(S)
DRAWING 405-01-C(2)	-	FLAGGING OPERATIONS MULTIPLE FLAGGERS TWO-LANE TWO-WAY ROADWAYS PRIMARY & SECONDARY ROUTES TRAFFIC SIGNAL CONTROLLED INTERSECTION FLAGGERS

- DRAWING 405-01-D(1)** - FLAGGING OPERATIONS
MULTIPLE FLAGGERS
TWO-LANE TWO-WAY ROADWAYS
PRIMARY & SECONDARY ROUTES
WORK ACTIVITY AREA
BEGINNING at an
INTERSECTION with a
TWO-LANE TWO-WAY ROADWAY
DEPARTURE LANE
- DRAWING 405-01-D(2)** - FLAGGING OPERATIONS
MULTIPLE FLAGGERS
TWO-LANE TWO-WAY ROADWAYS
PRIMARY & SECONDARY ROUTES
WORK ACTIVITY AREA
TERMINATING at an
INTERSECTION with a
TWO-LANE TWO-WAY ROADWAY
APPROACH LANE
- DRAWING 405-01-E(1)**
DRAWING 405-01-E(2) - FLAGGING OPERATIONS
MULTIPLE FLAGGERS
TWO-LANE TWO-WAY ROADWAYS
PRIMARY & SECONDARY ROUTES
WORK ACTIVITY AREA
INTERSECTIONS with
LOW SPEED
< / = 35 MPH
MULTILANE ROADWAYS
- DRAWING 405-01-F(1)**
DRAWING 405-01-F(2) - FLAGGING OPERATIONS
MULTIPLE FLAGGERS
TWO-LANE TWO-WAY ROADWAYS
PRIMARY & SECONDARY ROUTES
WORK ACTIVITY AREA
INTERSECTIONS with
INTERMEDIATE SPEED to HIGH SPEED
40 MPH - 60 MPH
MULTILANE ROADWAYS
- DRAWING 405-02** - FLAGGING OPERATIONS
SINGLE FLAGGER OPERATION
LOW VOLUME
LOW SPEED TO INTERMEDIATE SPEED
TWO-LANE TWO-WAY ROADWAYS
PRIMARY & SECONDARY ROUTES

ROAD CLOSURE

- DRAWING 705-02** - EXTENDED ROAD CLOSURE
FOR
BRIDGE WORK

DETOUR SIGNING

- DRAWING 805-01** - DETOUR SIGNING
FOR
PRIMARY & INTERSTATE ROUTES
- DRAWING 805-02** - DETOUR SIGNING
FOR
SECONDARY ROUTES

MULTILANE SECONDARY AND PRIMARY ROADWAYS

Lane closures are required for work activities that require equipment, personnel, materials, or any vehicles to encroach upon a travel lane or a shoulder area of a bridge or a bridge approach.

When determined necessary, install and maintain road closures and traffic detours for these work activities.

TYPICAL DRAWING APPLICATIONS

LANE CLOSURES

- | | | |
|-------------------------|---|--|
| DRAWING 505-01 | - | LANE CLOSURE
LOW SPEED MULTILANE
< / = 35 MPH
PRIMARY & SECONDARY ROUTES |
| DRAWING 505-03-A | - | LANE CLOSURE
INTERMEDIATE SPEED TO HIGH SPEED
40 MPH - 60 MPH
MULTILANE
PRIMARY & SECONDARY ROUTES |

ROAD CLOSURE

- | | | |
|-----------------------|---|---|
| DRAWING 705-02 | - | EXTENDED ROAD CLOSURE
FOR
BRIDGE WORK |
|-----------------------|---|---|

DETOUR SIGNING

- | | | |
|-----------------------|---|--|
| DRAWING 805-01 | - | DETOUR SIGNING
FOR
PRIMARY & INTERSTATE ROUTES |
| DRAWING 805-02 | - | DETOUR SIGNING
FOR
SECONDARY ROUTES |

INTERSTATE ROADWAYS

Lane closures are required for work activities that require equipment, personnel, materials, or any vehicles to encroach upon a travel lane or a shoulder area of a bridge or a bridge approach.

TYPICAL DRAWING APPLICATIONS

LANE CLOSURES

- | | | |
|-------------------------|---|---|
| DRAWING 510-01-A | - | LANE CLOSURE
INTERSTATE ROUTES |
| DRAWING 510-01-B | - | LANE CLOSURE
EXIT / ENTRANCE RAMPS
INTERSTATE ROUTES |
| DRAWING 510-02-A | - | DUAL LANE CLOSURE
TRANSITION / ACTIVITY AREAS
INTERSTATE ROUTES |
| DRAWING 510-02-B | - | DUAL LANE CLOSURE
ADVANCE WARNING AREA
INTERSTATE ROUTES |
| DRAWING 510-02-C | - | DUAL LANE CLOSURE
EXIT / ENTRANCE RAMPS
INTERSTATE ROUTES |

PERFORMANCE ACTIVITY 815

BRIDGE INSPECTION

WORK DESCRIPTION 1
WORK DESCRIPTION 2

Bridge Inspection
Overhead Sign Inspection

815 BRIDGE INSPECTION

ACTIVITY DESCRIPTION

Inspect state, county, city and private bridges.

WORK DESCRIPTION 1 Bridge Inspection

WORK DESCRIPTION 2 Overhead Sign Inspection

TRAFFIC CONTROL

CONDUCT THESE OPERATIONS PER DIRECTION OF THE DIRECTOR OF MAINTENANCE.