

SCDOT

South Carolina Department of Transportation

Highway Design Manual 2003

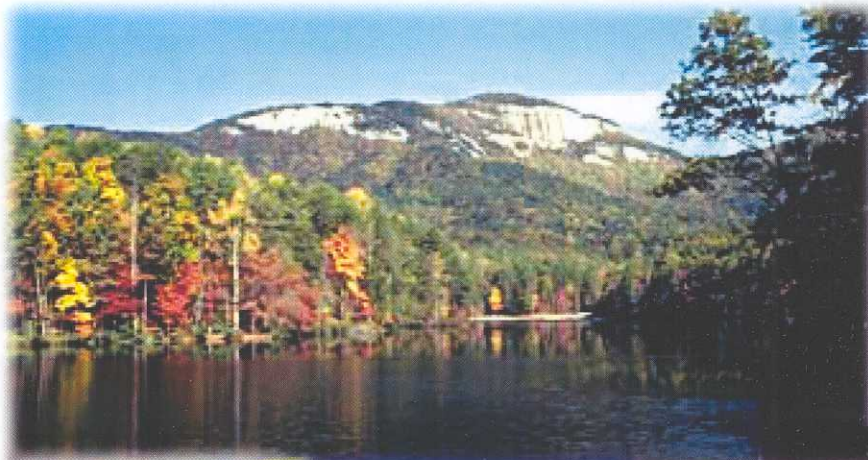

Photo by Kimberly D. Taylor

PREFACE

The *South Carolina Highway Design Manual* has been developed to provide uniform design practices for Department and consultant personnel preparing contract plans for Department projects. The designer should attempt to meet all criteria and practices presented in the *Manual*, while fulfilling the Department's operational and safety requirements. However, the *Manual* should not be considered a standard that must be met regardless of impacts. Designs will generally be made to values as high as are commensurate with conditions. Values approaching the minimums herein will be used only where the use of higher values will result in unacceptable effects on the economic, environmental, aesthetics, social and/or cultural resources of an area.

The *Manual* presents most of the information normally required in the design of a roadway project; however, it is impossible to address every situation that the designer will encounter. Therefore, designers must exercise good judgment on individual projects and, frequently, they must be innovative in their approach to roadway design. This may require, for example, additional research into highway literature.

A SCDOT task force under the direction of the Road Design Section developed the *SCDOT Highway Design Manual* with assistance from the engineering consultant firm of Roy Jorgensen Associates, Inc. and their subconsultant, the LPA Group, Inc.

HIGHWAY DESIGN MANUAL

Revision Process

The *South Carolina Highway Design Manual* is intended to provide current design and environmental policies and procedures for use in developing State highway projects. To insure that the *Manual* remains up-to-date and appropriately reflects changes in SCDOT's needs and applicable requirements, its contents will be updated on an ongoing basis.

SCDOT will be responsible for evaluating changes in highway design literature (e.g., the issuance of new research publications, revisions to Federal regulations) and will insure that those changes are appropriately addressed through the issuance of revisions to the *Manual*. It is important that users of the *Manual* inform SCDOT of any inconsistencies, errors, need for clarification or new ideas to support the goal of providing the best and most up-to-date information practical. A user who desires that a revision be considered for incorporation in the *Manual* should contact the Road Design Engineer to secure a Revision Request Form.

TABLE OF CONTENTS

Preface

Manual Revision

Table of Contents

PART I – GENERAL

Chapter One.....SCDOT ORGANIZATION
Chapter Two..... ADMINISTRATIVE POLICIES AND PROCEDURES
Chapter Three..... PROJECT DEVELOPMENT PROCESS
Chapter Four..... ROAD DESIGN COORDINATION
Chapter Five..... UTILITY COORDINATION
Chapter Six..... RAILROAD COORDINATION
Chapter Seven..... HIGHWAY FUNDING/SYSTEMS
Chapter Eight.....RESERVED

PART II – ROADWAY DESIGN ELEMENTS

Chapter Nine..... BASIC DESIGN CONTROLS
Chapter Ten..... SIGHT DISTANCE
Chapter Eleven..... HORIZONTAL ALIGNMENT
Chapter Twelve..... VERTICAL ALIGNMENT
Chapter Thirteen..... CROSS SECTION ELEMENTS
Chapter Fourteen.....ROADSIDE SAFETY
Chapter Fifteen..... INTERSECTIONS
Chapter Sixteen..... INTERCHANGES
Chapter Seventeen..... SPECIAL DESIGN ELEMENTS
Chapter Eighteen.....RESERVED

PART III – DESIGN OF FUNCTIONAL CLASSES

Chapter Nineteen	FREEWAYS
Chapter Twenty	RURAL HIGHWAYS
Chapter Twenty-One	SUBURBAN/URBAN STREETS
Chapter Twenty-Two	LOCAL ROADS AND STREETS
Chapter Twenty-Three	GEOMETRIC DESIGN OF 3R PROJECTS (NON-FREEWAYS)
Chapter Twenty-Four	RESERVED
Chapter Twenty-Five	RESERVED

PART IV – OTHER HIGHWAY DESIGN ELEMENTS

Chapter Twenty-Six	SURVEYS
Chapter Twenty-Seven	ENVIRONMENTAL PROCEDURES
Chapter Twenty-Eight	TRAFFIC ENGINEERING
Chapter Twenty-Nine	ROADWAY DRAINAGE
Chapter Thirty	RIGHT OF WAY
Chapter Thirty-One	MISCELLANEOUS DEPARTMENT DOCUMENTS
Chapter Thirty-Two	RESERVED

PART V – PLANS AND CONTRACTS

Chapter Thirty-Three	PROCEDURES FOR HIGHWAY PLANS PREPARATION
Chapter Thirty-Four	PLAN DEVELOPMENT
Chapter Thirty-Five	QUANTITIES
Chapter Thirty-Six	COST ESTIMATING
Chapter Thirty-Seven	BID DOCUMENT PROCESSING

GLOSSARY**INDEX**

Table of Contents

<u>Section</u>	<u>Page</u>
1.1 DEPARTMENT OF TRANSPORTATION COMMISSION	1.1(1)
1.2 EXECUTIVE DIRECTOR	1.2(1)
1.2.1 Deputy Director of Construction, Engineering and Planning	1.2(1)
1.2.2 Deputy Director of Strategic Planning, Finance and Administration	1.2(1)
1.2.3 Deputy Director of Mass Transit.....	1.2(1)
1.2.4 Deputy Director of Executive Support	1.2(2)
1.3 DEPUTY DIRECTOR OF CONSTRUCTION, ENGINEERING AND PLANNING.....	1.3(1)
1.3.1 Deputy State Highway Engineer of Preconstruction and Planning ...	1.3(1)
1.3.1.1 Planning Division	1.3(1)
1.3.1.1.1 Environmental Management Office.....	1.3(1)
1.3.1.2 Preconstruction Division	1.3(2)
1.3.1.2.1 Program Development Section (East and West)	1.3(2)
1.3.1.2.2 Program Management Section	1.3(3)
1.3.1.2.3 Surveys/Utilities Office	1.3(4)
1.3.1.2.4 Hydraulic Engineering Section	1.3(5)
1.3.1.2.5 Right of Way Office	1.3(5)
1.3.1.2.6 Road Design Section	1.3(6)
1.3.1.2.7 Bridge Design Section.....	1.3(9)
1.3.2 Deputy State Highway Engineer of Operations	1.3(10)
1.3.2.1 Construction Division	1.3(10)
1.3.2.1.1 Road Construction	1.3(11)
1.3.2.1.2 Bridge Construction.....	1.3(12)
1.3.2.1.3 Research and Materials Lab/Quality Management Team.....	1.3(12)
1.3.2.1.4 Contracts Administration Office.....	1.3(12)
1.3.2.2 Maintenance Division.....	1.3(12)

Table of Contents

(Continued)

<u>Section</u>	<u>Page</u>
1.3.2.3 Traffic Engineering Division	1.3(13)
1.3.2.3.1 Traffic Operations.....	1.3(13)
1.3.2.3.2 Traffic Safety and Systems	1.3(14)
1.3.2.3.3 Road Data Services	1.3(14)
1.3.2.4 District Offices	1.3(15)
1.3.2.5 Safety Office	1.3(16)
1.4 DEPUTY DIRECTOR OF STRATEGIC PLANNING, FINANCE AND ADMINISTRATION	1.4(1)
1.5 DEPUTY DIRECTOR OF MASS TRANSIT	1.5(1)
1.6 DEPUTY DIRECTOR OF EXECUTIVE SUPPORT	1.6(1)
1.6.1 Human Resources	1.6(1)
1.6.2 Special Assistants	1.6(1)
1.6.3 Legal Services.....	1.6(1)

Chapter One

SCDOT ORGANIZATION

This Chapter discusses the organization and responsibilities of those Units within the South Carolina Department of Transportation. The Chapter is intended to provide the user with general guidance on the structure of SCDOT and the responsibilities of these Units. Note that not all SCDOT Units have been addressed in this Chapter. The organizational chart provided in [Figure 1.1A](#) shows the structure of the Department.

1.1 DEPARTMENT OF TRANSPORTATION COMMISSION

The Department of Transportation Commission includes seven commissioners. One commissioner is from each of the six Congressional Districts and the Governor appoints the seventh commissioner.

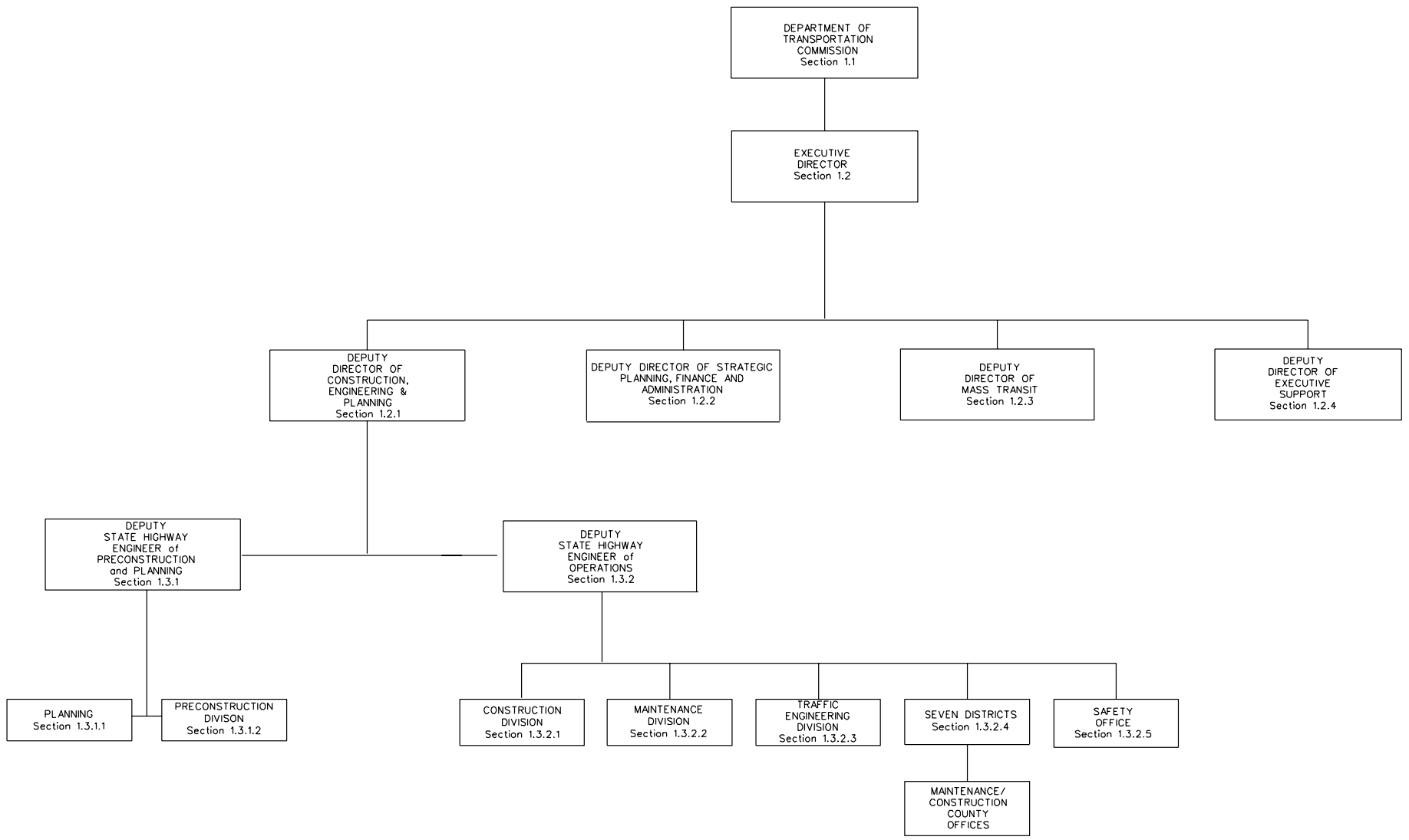

SCDOT ORGANIZATION

Figure 1.1A

1.2 EXECUTIVE DIRECTOR

The Commission appoints the Executive Director who manages the:

- Deputy Director of Construction, Engineering and Planning;
- Deputy Director of Strategic Planning, Finance and Administration;
- Deputy Director of Mass Transit; and
- Deputy Director of Executive Support.

1.2.1 Deputy Director of Construction, Engineering and Planning

The Deputy Director of Construction, Engineering and Planning identifies the duties and responsibilities of the Construction, Engineering and Planning Divisions as the development of the statewide strategic highway plans and the administration of all highway engineering activities including the planning, design, construction and maintenance of State highways. See [Section 1.3](#) for more details.

1.2.2 Deputy Director of Strategic Planning, Finance and Administration

The Deputy Director of Strategic Planning, Finance and Administration is responsible for the Department's financial planning and management, developing the accounting systems necessary to comply with laws and regulations established by the Federal and State government and all policies established by the Comptroller General and all administrative functions which relate to the Transportation Commission. See [Section 1.4](#) for more details.

1.2.3 Deputy Director of Mass Transit

The Deputy Director of Mass Transit is responsible for administration of public transit programs designed to benefit the elderly, disabled and general public in rural and urban areas. Specifically, the Office is responsible for advising counties, cities and transportation authorities and private organizations of the availability of Federal and State public transit funds. This Office reviews local requests to fund programs (most of which involves purchase or replacement of vans, buses and trolleys), coordinates with the Urban Mass Transit Administration (UMTA) for program approval, develops and administers the bid procedure for purchase of the vehicles and conducts periodic inspections throughout the useful life of the vehicles. In addition to acquiring vehicles, public transit funds may be used to finance such items as communications equipment, wheelchair lifts, bus shelters and maintenance facilities. For more information, see [Section 1.5](#).

1.2.4 Deputy Director of Executive Support

The Deputy Director of Executive Support is responsible for working with the Agency Director in carrying out the policies of the Commission and administering the affairs of the Department. For more information, see [Section 1.6](#).

1.3 DEPUTY DIRECTOR OF CONSTRUCTION, ENGINEERING AND PLANNING

The Deputy Director of Construction, Engineering and Planning oversees the Deputy State Highway Engineer of Preconstruction and Planning, discussed in [Section 1.3.1](#) and the Deputy State Highway Engineer of Operations, discussed in [Section 1.3.2](#). The Deputy Director also has the title of State Highway Engineer.

1.3.1 Deputy State Highway Engineer of Preconstruction and Planning

The Deputy State Highway Engineer of Preconstruction and Planning oversees the programming and development of plans for transportation projects.

In addition to the Planning and Preconstruction Divisions, discussed in [Sections 1.3.1.1](#) and [1.3.1.2](#), respectively, the Bicycle/Pedestrian Accommodation Program and Enhancement Program Units report directly to the Office of the Deputy State Highway Engineer of Preconstruction and Planning.

1.3.1.1 Planning Division

The Planning Division is responsible for the development and implementation of the processes, systems and planning programs necessary for informed programming decisions of the Department's transportation projects. The Planning Division insures that the Department meets all State and Federal planning requirements. The Division also maintains an effective public involvement program ranging from news releases to formal public hearings. The Planning Division is responsible for conducting the following studies:

- Long-Range Project Proposals,
- Social and Economic Studies,
- Demographic Studies,
- Concept Studies, and
- Corridor Studies.

1.3.1.1.1 Environmental Management Office

The Environmental Management Office supervises both the environmental and permitting work during the preconstruction process. Environmental documentation is mandated for all highway improvement projects receiving Federal funds. The procedures include the preparation of the appropriate environmental documents and the conducting of public hearings. The purpose of this work is to make environmental impacts less severe. Both the State and Federal governments require permits for work in areas under State and Federal protection (e.g., wetlands, navigable waterways,

critical coastal areas). The Environmental Management Office also provides data and recommendations to Department management concerning environmental or permitting considerations that will affect highway improvements. When an environmental document is required, this Office determines the type of document that is to be prepared (i.e., environmental impact statement, categorical exclusion or environmental assessment).

Within the Environmental Management Office, there are two units:

1. Environmental Process Unit. The Environmental Process Unit is responsible for:
 - conducting the necessary environmental studies to evaluate the social, economic and environmental impacts of the proposed improvements;
 - preparing required environmental documents;
 - conducting public hearings and coordinating the preparation of the necessary graphics; and
 - preparing the necessary documentation for location/design approval for projects requiring a Finding of No Significant Impact (FONSI) or Final Environmental Impact Statement (FEIS).
2. Permits Unit. The Permits Unit coordinates and manages the work associated with the permits required for all projects. The work of the Permits Unit often carries over into the construction of the project. This work includes:
 - evaluating projects to determine the need for various types of permits;
 - securing the necessary permits;
 - monitoring permits; and
 - renewing the permits, as required.

1.3.1.2 Preconstruction Division

1.3.1.2.1 Program Development Section (East and West)

The Program Development Section is divided into two regions (i.e., East and West). Program Managers within these Sections serve as the lead for a project as it progresses through the preconstruction process. The Program Managers direct, coordinate and consult with the other involved units directly involved with the project design. Program Managers are also responsible for interacting with the public and outside agencies. All major decisions on the project must be coordinated with the Program Manager. Program Managers also monitor the progress of projects during construction to insure adequate funding is available.

The Program Development Section furnishes information and recommendations to Department management (e.g., State Highway Engineer, Director of Preconstruction). The Program Development Section also assists in the establishment of objectives for funding programs and construction schedules. The Program Development Section's involvement in this effort is required so that the projects will be ready for letting.

In addition to Program Managers, the Project Development Section contains the following units:

1. C Project Development Group. This Unit is responsible for managing all preconstruction projects funded using C funds.
2. Preliminary Design Group. The Preliminary Design Group is responsible for the geometric design and layout for all major projects (e.g., new alignments, interchanges, major intersections). This Unit is also responsible for determining the design criteria to be used on a project (e.g., design speed, sight distance, alignment).
3. Value Engineering and Cost Estimating Group. This Unit is responsible for reviewing major projects to insure the design is cost effective. This Unit will review the project's design with the purpose of considering alternative designs, materials and/or innovative construction methods.

1.3.1.2.2 Program Management Section

Within the Program Management Section there are the following sections:

1. Preconstruction Management Section. The Preconstruction Management Section is responsible for the scheduling, programming and funding of projects. The Section also reviews State laws and Federal guidelines so that the Department can take advantage of all available funding. The Section assists in the development of long- and short-range highway improvement programs and coordinates the financing for each project. The Section prepares a tentative list of projects that are to be initiated. This list is based on the State Transportation Improvement Program (STIP), the SCDOT Obligation Schedule and funding availability.

To assess funding for project development and construction, the Preconstruction Management Section prepares a budget for financing highway improvement projects. These estimates are based on past revenues and future revenue projections.

The Preconstruction Management Section also manages the Department's project database and programs highway improvement projects. The database reflects project information that includes:

- significant dates,
 - costs,
 - location,
 - type of work, and
 - identification numbers.
2. Federal-aid Unit. Within the Preconstruction Management Section is the Federal-aid Unit. The Federal-aid Unit coordinates all communications, programs and funding between SCDOT and FHWA. All official SCDOT transactions with FHWA are forwarded through the Federal-aid Unit. The Federal-aid Unit's responsibilities include:
- maintaining and letting the Department's Federal construction program documents and historical records on all State and Federal highway improvement projects;
 - updating a list of recommended highway improvement projects;
 - preparing and organizing all documentation requesting Federal funds for preliminary engineering, right of way and construction; and
 - preparing agreements and modified agreements for reimbursement of the portion of the funds covered by FHWA obligations.

1.3.1.2.3 Surveys/Utilities Office

The primary responsibilities of this Office are to oversee the coordination with utility companies and provide various topographic surveys for projects depending on the scope of the project. They are also responsible for determining the level of Subsurface Utility Engineering (SUE) involvement on a project.

Within the Surveys/Utilities Office there are the following sections:

1. Utilities Office. The Utilities Office is responsible for preparing agreements with and coordinating the relocation, modification or maintenance of utility and railroad facilities affected by highway improvement projects. Utilities and railroads pose special needs in that they may have to be relocated or modified in a manner as to not disrupt their services. The Utilities and Railroad Units work directly with the utility and railroad companies. The Utilities and Railroad Units review the project plans to identify any involved companies. After reviewing the plans, the Units notify the involved companies and negotiate any necessary agreements. After the project has been let for construction, the Section notifies the involved companies so they can relocate or update their services.

The Railroad Unit is also responsible for implementation of the Flashing Light Signal Program and is involved in the selection of sites for these installations.

2. Surveys Office. The Surveys Office documents the field conditions and researches property boundaries and ownership. This work is done prior to the drafting of the road or bridge plans. This Office supervises and assigns the survey work to crews that conduct the actual field surveys. This Office also coordinates with the Preconstruction Divisions and Sections requesting the work to insure that the crews understand and satisfy the survey requests. The survey crews' work include:

- conducting field surveys of the proposed projects,
- preparing survey notes,
- documenting property layouts, and
- providing base mapping to road design.

1.3.1.2.4 Hydraulic Engineering Section

The Hydraulic Engineering Section supervises the preparation of both drainage and conveyance designs by the Hydraulic Design Groups. The Section also coordinates with other Preconstruction Units (e.g., Surveys, Bridge Design, Program Development) to insure that hydraulic designs meet the needs of the project and that all the necessary data has been collected.

The Hydraulic Design Groups conduct hydrological studies to determine requirements for drainage structures or systems. After analyzing stream flow data and the drainage basin, the Group prepares the hydraulic designs for highway drainage structures and systems. After the hydraulic designs have been completed, the Hydraulic Design Section checks the designs for accuracy and completeness. The project is then reviewed with other Preconstruction Units to insure that the designs are compatible with the remainder of the project.

1.3.1.2.5 Right of Way Office

The Right of Way Office is responsible for all right of way work within the Department and for insuring that all right of way properties are secured before the construction contracts are awarded.

The following units are within the Right of Way Office:

1. Field Operations. Field Operations consist of the following:

- a. Right of Way Agents. Right of Way agents serve as the liaison between the Department and the property owners from whom the property is being acquired and resolve property acquisition problems.
 - b. Appraisal Unit. The Appraisal Unit is responsible for determining preliminary right of way costs for the project and for determining the fair market value for property being acquired by the Department.
2. Central Office Operations. The Central Office Operations consist of the following units:
- a. QC/QA Unit. The QC/QA Unit is responsible for updating and maintaining the Department's right of way records after the property has been purchased. The Unit is responsible for maintaining the right of way instruments (e.g., deeds, condemnations, easements).
 - b. Condemnation Unit. The Condemnation Unit becomes involved in the right of way process when the Department cannot reach an agreement with the property owner and property has to be condemned.
 - c. Claims Unit. The Claims Unit is responsible for checking the right of way acquisition documents and preparing the claims for right of way payments, including payments for support work (e.g., legal services, appraisal contracts). This Unit is also responsible for preparing any right of way special provisions.
 - d. Relocation Unit. The Relocation Unit assists in the relocation of parties displaced from property being acquired by the Department.
 - e. Property Management Section. This Unit is responsible for maintaining surplus property acquired by the Department.

1.3.1.2.6 Road Design Section

The Road Design Section is responsible for the development of the roadway plans for highway projects. This Section consists of the following Units:

1. Road Design Groups. The Road Design Groups prepare the road design plans and insure all designs are in accordance with State policies, procedures and guidelines. The Road Design Groups coordinate with other Preconstruction Units to incorporate their work and designs into the final road plans (e.g., Traffic Engineering, Bridge Design, Hydraulic Engineering). The Road Design Groups are responsible for:
 - developing topography and plan profiles,
 - developing roadway grades,

- developing cross sections and plotting templates, and
 - finalizing the road plans.
2. CADD Support. CADD Support is responsible for assisting designers in the use of the Department's computer-aided drafting and design packages (i.e., MicroStation and GEOPAK). This includes:
- developing uniform conventions for the use of CADD,
 - providing technical support to all CADD users,
 - upgrading the CADD package as necessary, and
 - maintaining the *SCDOT Road Design CADD Users Guide*.
3. Roadway Structures Design Group. The Roadway Structures Design Group is responsible for all in-house roadway structural designs and related construction issues. The Group produces engineering designs for roadway and hydraulic structures that are required due to roadway design. The Roadway Structures Design Group is responsible for requesting roadway geotechnical design information and using these recommendations to design roadway and drainage structures. Typical roadway structures would include the structural design and analysis of retaining walls, roadside barriers, temporary shoring, embankments, roadway cuts and subgrade improvements. Typical hydraulic structures would include box culverts, rectangular precast concrete boxes and special and modified drainage structures. The Group prepares plans and computes bid quantities of these specific roadway and hydraulic structures. The Group reviews shop drawings, engineering design drawings and structural engineering calculations of all submittals from contractors, consultants and manufacturers to insure conformance with SCDOT design standards and policies. The Group is responsible for all structural designs required in the *Standard Drawings*.
4. Letting Preparation Group. The Letting Preparation Group consists of the following:
- a. Operations Center/Specifications and Estimates Group. The Operations Center and the Specifications and Estimates Group are responsible for preparing the bid proposal documents for letting. This includes:
- receiving the road plans from the Road Design Groups and other Units (e.g., Bridge Design, Traffic Engineering, Consultants);
 - insuring the road plans have been reviewed by the applicable Units and have all the necessary signatures;
 - requesting and submitting necessary prints to other agencies;
 - calculating the road plan cost for letting;
 - preparing the Engineer's Estimate;
 - calculating the contract completion date;

- preparing Bid Proposals;
 - developing uncommon Special Provisions; and
 - assembling all the documents for printing.
- b. Engineering Reproductions Services/Plans Storage. Engineering Reproductions Services is responsible for any printing required by the Road Design Section (e.g., Field Review Plans, Bid Proposals) or other Sections. The Plans Storage Unit is responsible for cataloging and storing the design plans after they have been forwarded to the Contract Administration Office for letting.
5. Engineering/Consultant Services Unit. For projects where a consultant does the road design work, this Unit is involved at all stages, beginning with the advertising of the proposed contract to the final review of the submitted plans. The Engineering Consultant Services Group:
- evaluates consultant's qualifications;
 - makes recommendations to the Selection Committee as to a consultant's qualifications and suitability for a particular project;
 - assists in the preparation of consultant agreements;
 - reviews proposal for road design services from consultants for other SCDOT sections;
 - prepares man-hour estimates for comparisons and negotiations of contracts;
 - provides consultants with necessary information to design projects; and
 - reviews consultant plans for accuracy, completeness and compliance with Department criteria.

The Engineering/Consultant Services Unit also contains the following Units:

- a. Engineering Support. Engineering Support is responsible for day-to-day support of Road Design by:
- researching technical manuals and advisory materials,
 - coordinating the development and updating of engineering reference materials,
 - creating and reviewing standard drawings for road construction,
 - presenting training classes,
 - providing daily on-call assistance with standard road design applications, and
 - making field inspections when called upon.
- b. Engineering Visualization. Engineering Visualization is responsible for creating public hearing maps and other displays for public meetings.

- c. Design Services Group. The Design Services Group is responsible for conducting a quality control review of the final construction plans prepared by the Road Design Groups. The Design Services Group is also responsible for small safety projects and other special projects.

1.3.1.2.7 Bridge Design Section

The Bridge Design Section is responsible for the design and project coordination of bridges and other structures. It is also responsible for evaluating their designs in terms of the technical requirements, costs, structural integrity and safety.

The Bridge Design Section is organized into the following Units:

1. Bridge Design Unit. The Bridge Design Unit is organized into the following Teams:
 - a. Bridge Design Teams. The Bridge Design Teams prepare the bridge designs, conduct structural analyses of the proposed structures, prepare the bridge plans and compute bid quantities for bridge projects. The Teams also prepare the plans for special structures (e.g., pedestrian overpasses, catwalks). The Teams are responsible for reviewing and checking the plans for completeness and accuracy. In preparing the plans and the Special Provisions, the Bridge Design Teams coordinate with other SCDOT Units to insure the plans and the contract documents reflect the work of other SCDOT Units. Once the project has been let, the Teams review the shop plans for compliance with the plans and contract specifications.
 - b. Geotechnical Team. The Geotechnical Team evaluates soils investigations at the proposed bridge project site. The Team prepares foundation recommendations from the geotechnical analysis.
 - c. Seismic Team. The Seismic Team develops policies to be applied to bridge projects according to the latest practices, including the implementation and review of the Seismic Design Specifications. The Team reviews and provides comments to bridge plans for concurrence with seismic performance. They prepare seismic design scope of services for bridge projects. The Team also monitors the latest developments in seismic design of bridges by active participation in committees and workshops.
2. Bridge Estimate Unit. The Bridge Estimate Unit prepares preliminary cost estimates for the proposed structures. The Unit performs a cost analysis for each bridge construction contract. The results of this analysis are used for comparison with the contractors' bid.

3. Bridge Consultant Unit. The Bridge Consultant Unit:
 - evaluates consultant's qualifications;
 - makes recommendations to the Selection Committee as to a consultant's qualifications and suitability for a particular project;
 - assists in the preparation of consultant agreements;
 - provides consultants with necessary information to design projects;
 - reviews consultant plans for accuracy, completeness and compliance with Department criteria; and
 - coordinates project management for bridge replacement projects.

4. Bridge Replacement Program Management Unit. The Bridge Replacement Program Management Unit programs and coordinates the design and plan preparation of bridge replacement project, including both the bridge and roadway approaches. The coordination of projects involves all groups required in the plan preparation process, including Bridge Design Teams, Road Design Groups, Hydraulic Engineering, Environmental Management Office, Right of Way Office and design consultants.

1.3.2 Deputy State Highway Engineer of Operations

In addition to the Divisions discussed in this Section, the following Units report to the Deputy State Highway Engineers:

- Engineering Expert Testimony (e.g., court cases involving State highway projects);
- Special Projects (e.g., preparing responses to political questions and general inquiries made by the public);
- Outdoor Advertising;
- Roadside Management;
- Oversize/Overweight Permits;
- Supply and Equipment Depot;
- Facilities Engineering (e.g., rest areas, weight stations); and
- Risk Management.

1.3.2.1 Construction Division

The Construction Division provides support to the District Engineering Administrators, District Construction Engineers and, as needed, the Resident Construction Engineers during project construction.

The Construction Division coordinates with the Preconstruction Division to finalize bid proposals for letting. The Construction Division oversees the bidding and letting process

and, once awarded, is responsible for administering the contract through project closure. The overall responsibilities of the Construction Division include:

- establishing policies and procedures for administering contracts,
- conducting contractor prequalification and contract letting,
- maintaining the *SCDOT Construction Manual*,
- developing specifications for contract pay items and construction materials,
- evaluating new construction methods and procedures,
- approving subcontracts,
- reviewing Traffic Control Plans,
- monitoring project inspection practices,
- reviewing bridge false work and cofferdam drawings,
- administering the contractor overtime law,
- approving major change orders,
- investigating damage and defects in structural elements,
- resolving contractor claims that reach impasse or litigation,
- evaluating value engineering proposals,
- approving monthly estimates,
- conducting quality management,
- coordinating with other State agencies, and
- process contract modification and supplemental agreements.

1.3.2.1.1 Road Construction

Road Construction is primarily responsible for supporting the District Construction Engineers and, as needed, Resident Construction Engineers during construction. Assistant Construction Engineers are also responsible for coordinating with FHWA Area Engineers for Federal-aid projects. Implementation and data archival for contract computer applications (e.g., BAMS, DSS, PES/LAS, Bid Express, Expedite, SiteManager) is overseen by the Computers Applications Manager in Road Construction.

At the District level, the District Engineering Administrator is responsible for the overall operations of the District Office. The District Construction Engineer reports directly to the District Engineering Administrator and oversees the Resident Construction Engineers and Inspectors who are assigned to the projects. The District Construction Engineer also oversees the duties of the District Asphalt Manager and Asphalt Plant Inspectors.

At the project level, the Resident Construction Engineer maintains direct liaison with the project's Contractor Superintendent and is responsible for the day-to-day administration of the contract. The Resident Construction Engineer is directly responsible for the county office, authorized Inspectors' work, Daily Work Reports and monitors the project

schedule. Project Inspectors (e.g., engineering technicians, geodetic surveyors, plant inspectors, roadway inspectors, bridge inspectors) input pay item quantities, accept or reject work and materials and insure that projects are constructed in accordance with the contract plans and specifications.

1.3.2.1.2 Bridge Construction

Bridge Construction's primary function is to provide District Construction Engineers with construction engineering and inspection services for project bridges and structures. This may consist of checking structural shop drawings or providing bridge inspection services.

1.3.2.1.3 Research and Materials Lab/Quality Management Team

The Research and Materials Lab and the Quality Management Team are responsible for the preapproval of materials sources and the quality assurance of materials used in construction, including:

- establishing approval policies for construction and maintenance materials;
- approving material sources and publishing source approval lists;
- inspecting fabricators, mills and shops;
- establishing certification requirements for quality managers and technicians;
- performing quality assurance, independent assurance and verification sampling and testing;
- performing annual checks of PCC source materials, plants, scales and trucks;
- verifying mill test reports and performing non-destructive testing;
- setting QC/QA policies for HMA plants and inspections;
- inspecting and certifying HMA plant laboratories; and
- providing assistance to District Asphalt Managers and Inspectors.

1.3.2.1.4 Contracts Administration Office

The Contracts Administration Office prepares contractual documents for construction contracts. The Contracts Administration Office coordinates with the Preconstruction Program Manager and the Director of Construction to initialize project data for administering the contract using SiteManager.

1.3.2.2 Maintenance Division

The Maintenance Division is responsible for the development and monitoring of the maintenance for all State-maintained roadways, SCDOT vehicles and equipment, all

Department facilities and a statewide communications system. The Maintenance Division's primary function is to maintain State roadways and bridges for the safety of the traveling public and to prevent roadways and bridges from wearing out prematurely. Maintenance activities include pothole repair, crack filling, patching, grading of earth shoulders and roadways, clearing drainage ditches and pipes of debris, vegetation control, roadway striping, guardrail maintenance, winter roadway maintenance, and rest area and weigh station maintenance. Maintenance activities may also include physical improvements to the traveled way (e.g., seal coating and thin lift resurfacing) to extend roadway life until reconstruction can occur.

The Maintenance Division conducts bridge and sign inspections and maintains the Department's bridge and sign inspection database.

1.3.2.3 Traffic Engineering Division

The Traffic Engineering Division is responsible for implementation of traffic control devices (e.g., signing, pavement markings, traffic signals, work zones), traffic management systems, safety programs and roadway data collection. The Traffic Engineering Division is divided into three functional areas — Traffic Operations, Traffic Safety and Systems and Road Data Services. The following Sections further describe these functional areas. In addition to the Units in the following sections, the Traffic Program Unit is responsible for the general administration of the Division, contract administration, technology and the Division's publications.

1.3.2.3.1 Traffic Operations

Traffic Operations is comprised of the following Units:

1. Special Projects and Operations. This Unit is responsible for traffic functions that require statewide coordination, providing operational assistance to the Districts and coordinating with other Divisions and Sections within SCDOT on traffic related issues. The Unit's primary functions include correspondence, traffic studies, traffic access reviews, preemption of traffic signals for at-grade rail crossings, special signing projects and other traffic projects that are unique.
2. Intersection Improvements. This Unit is responsible for analyzing intersections for minor geometric changes that will reduce congestion, improve operations and lower crashes. This Unit ranks these intersection improvements to determine the most cost-effective improvements.
3. Traffic Design Review. The Traffic Design Review Unit analyzes and evaluates the geometric design of highway construction plans. They prepare before and after studies to evaluate the benefits, operation characteristics and net worth of a

project. They are responsible for conducting special traffic engineering studies to gather facts on traffic conditions.

4. Work Zone Traffic Control. This Unit prepares the plans, Special Provisions, specifications and quantities for traffic control devices used on road and bridge construction and maintenance projects.
5. Signing and Marking Plan Preparations. This Unit is responsible for preparing Sign and Pavement Marking Plans, quantities and any associated Special Provisions.
6. Traffic Services and Contract Management. This Unit is responsible for administrating pavement marking and signing contracts let by the Traffic Engineering Division, reviewing requests for special guide signs, maintaining permanent crash attenuators, maintaining Interstate guide sign inventories and administrating the Sign Structure Inspection Program.

1.3.2.3.2 Traffic Safety and Systems

Traffic Safety and Systems consists of the following Units:

1. Advance Traffic Management Systems. This Unit is responsible for preparing plans and specifications for closed-loop traffic signal systems. This Unit is also responsible for the implementation of SCDOT's ITS program. This Program includes closed circuit television cameras, electronic detection devices, coordinated signal systems, changeable message signs, highway advisory radio and statewide coordination of SCDOT's Incident Management and Motorist Assistance Program.
2. Rail and Research. This Unit manages the Department's Railroad Crossing Safety Program, which identifies deficient rail-highway grade crossings and establishes a priority for installing improved traffic controls.
3. Traffic Safety Programs. This Unit is responsible for the Department's Hazard Elimination Program (Highway Safety Improvement) and the School Operations Program. After analyzing these locations, the sites are prioritized for possible improvement projects.

1.3.2.3.3 Road Data Services

Road Data Services consists of the following Units:

1. Pavement Management. The Pavement Management Unit is responsible for collecting, analyzing and storing roadway surface distress and roughness data.

2. GIS/Mapping. The GIS/Mapping Unit is responsible for the Department's Hurricane Evacuation website and for creating, updating and publishing State, county and municipal maps.
3. GIS Data Collection/Inventory. This Unit is responsible for the collection and storage of roadway and bridge data. This includes characteristic data of highways and bridges, traffic volumes, speed data and weigh-in-motion data.

1.3.2.4 District Offices

The Department maintains seven District Offices based on geographic areas in the cities of Columbia, Greenwood, Greenville, Chester, Florence, Charleston and Orangeburg. Each District Office is staffed with a District Engineering Administrator. All construction work and maintenance is under the jurisdiction of the District Engineering Administrator. The District Engineering Administrator is responsible for seeing that the proper results as specified in the construction contracts are obtained and that the bridges and roads are adequately maintained after acceptance from contractors. The basic function of each District Office is to provide the necessary field services for the Department and oversee the Maintenance/Construction County Offices within their geographic boundaries. Some of the District responsibilities include:

- maintaining the State Highway System (e.g., pavement maintenance);
- providing construction inspection for Department construction projects;
- nominating projects for capital improvements;
- reviewing and approving requests for private access onto the State Highway System;
- serving as liaison between the local governments and the Department's Central Office;
- reviewing and commenting on the proposed traffic control plan during construction; and
- responding to public inquiries.

Each of the seven District Offices has the following units:

- Construction,
- Maintenance,
- Mechanical Services,
- Bridge Inspection,
- Advertising Control,
- Traffic Engineering,
- Human Resources,
- Safety/Environmental, and
- IT Services.

1.3.2.5 Safety Office

The Safety Office is responsible for developing and implementing guidelines to reduce the number of work-related injuries and illnesses for Department employees.

1.4 DEPUTY DIRECTOR OF STRATEGIC PLANNING, FINANCE AND ADMINISTRATION

The following Units and Offices are within the Office of Deputy Director of Strategic Planning, Finance and Administration:

- Information Technology;
- DBE Program and Development;
- Procurement;
- Assets Management (Building Maintenance);
- Office of Financial Management (Comptroller, Financial Planning/Cash Management, Budget, Accounting, Revenue/Debt Management);
- Contract Program Resource Services; and
- Employee Services (staff development and training, medical services, career development, rewards/recognition, parking, library).

1.5 DEPUTY DIRECTOR OF MASS TRANSIT

The Deputy Director of Mass Transit is responsible for program management, program budgets and controls, management systems, and technical support for mass transit systems (e.g., buses) in South Carolina.

The specific tasks of this Office include:

- coordinating public transportation projects,
- administering transit grants,
- providing transit training,
- obtaining and distributing transit technology statewide,
- administering Federal Transit Earmarks,
- coordinating the Job Access and Reverse Commute Program,
- administering the Rail Corridor Preservation Program, and
- coordinating the Federal Aid – Mass Transit Preservation.

1.6 DEPUTY DIRECTOR OF EXECUTIVE SUPPORT

The Office of Executive Support provides the necessary technical support in the development and advancement of highway projects. In addition to Community Development, Central Files, Office of Communication, Postal Center and Internal Program Evaluation, the following Units are within this Office:

1.6.1 Human Resources

Human Resources is responsible for classification, compensation, employment, affirmative action (internal complaints) and labor relations for SCDOT. The activities undertaken by the Division include coordination of employee recruitment, hiring, employment records, employee benefits and salary determinations.

1.6.2 Special Assistants

Special Assistants serve in a supporting role to the Office of Executive Support. There are two Special Assistants, a Hearings Officer and Emergency Preparedness. The Hearings Officer specifically deals with internal matters (e.g., matters that require a hearing before a Department official). Emergency Preparedness is responsible for updating and maintaining an emergency preparedness plan for natural disaster occurrences (e.g., snow, hurricanes). These plans take into account traffic planning and evacuation routes relating to the use of the State Highway System.

1.6.3 Legal Services

The Legal Services Department is responsible for serving as legal counsel for the Department. Specifically, the responsibilities of Legal Services include, but are not limited to:

- providing legal advice and assistance to the Department's Divisions and Districts,
- investigating the legality of agency actions and validity of public complaints,
- drafting proposed legislation and administrative rules,
- researching and interpreting Statutes,
- preparing legal opinions,
- attending and testifying at legislative committee hearings,
- providing litigation support,
- conducting administrative hearings,
- providing guidance on contract matters, and
- performing related duties.

Table of Contents

<u>Section</u>	<u>Page</u>
2.1 LAWS AND REGULATIONS GOVERNING DESIGN.....	2.1(1)
2.1.1 Introduction.....	2.1(1)
2.1.2 South Carolina Codes and Regulations	2.1(1)
2.1.2.1 <i>Code of Laws of South Carolina</i>	2.1(1)
2.1.2.2 South Carolina Regulations	2.1(2)
2.1.3 United States Code of Laws and Regulations	2.1(3)
2.1.4 Federal Highway Administration Policy and Procedures	2.1(3)
2.1.5 American Association of State Highway and Transportation Officials	2.1(3)
2.1.6 Other Agencies.....	2.1(4)
2.2 MANAGEMENT RESPONSIBILITIES	2.2(1)
2.2.1 Program Management.....	2.2(1)
2.2.2 Quality Assurance/Quality Control.....	2.2(1)
2.2.3 Evaluation.....	2.2(2)
2.3 ENGINEERING MEMORANDA.....	2.3(1)
2.3.1 Engineering Policy Memoranda.....	2.3(1)
2.3.2 Engineering Directive Memoranda	2.3(1)
2.3.3 Instructional Bulletins	2.3(2)
2.3.4 Other Instructional Bulletins.....	2.3(2)
2.4 PARTICIPATION AGREEMENTS.....	2.4(1)
2.4.1 Purpose	2.4(1)
2.4.2 Application.....	2.4(1)
2.4.3 Content.....	2.4(2)
2.4.4 Responsibilities	2.4(3)
2.5 PUBLIC INVOLVEMENT	2.5(1)
2.5.1 Introduction.....	2.5(1)
2.5.2 Types of Public Involvement.....	2.5(1)

Table of Contents

(Continued)

<u>Section</u>	<u>Page</u>
2.5.2.1 Workshops/Partnering	2.5(1)
2.5.2.2 Informational Meetings	2.5(2)
2.5.2.3 Informal Public Hearings.....	2.5(2)
2.5.2.4 Formal Public Hearings	2.5(2)
2.5.3 Coordination	2.5(3)
2.5.3.1 General.....	2.5(3)
2.5.3.2 Project Coordination Meetings.....	2.5(3)
2.5.4 Public Involvement Program Requirements	2.5(3)
2.5.4.1 Federal and State	2.5(3)
2.5.4.2 FHWA Environmental Regulations	2.5(4)
2.6 CONSULTANT PROJECT PROCEDURES	2.6(1)
2.6.1 Construction and Resource Management Program	2.6(1)
2.6.2 Consultants	2.6(1)
2.6.2.1 General.....	2.6(1)
2.6.2.2 Project Implementation	2.6(1)
2.7 VALUE ENGINEERING.....	2.7(1)
2.8 REFERENCES.....	2.7(1)

Chapter Two

ADMINISTRATIVE POLICIES AND PROCEDURES

2.1 LAWS AND REGULATIONS GOVERNING DESIGN

2.1.1 Introduction

Highway designers are guided primarily by engineering principles and practices in making design calculations, developing design details and determining design requirements for each of their projects. However, they may also be performing work under the provisions or direction of Federal and State laws, regulations, rules, directives or other documents that have been enacted or issued. The following are some examples:

- *Code of Laws of South Carolina*;
- *United States Code of Laws* and *Code of Federal Regulations* (CFR);
- South Carolina Department of Transportation, Engineering Policy Directives;
- Federal Highway Administration policy and procedures;
- policies, criteria, and guides of the American Association of State Highway and Transportation Officials (AASHTO); and
- criteria and guidance of other agencies (e.g., Corps of Engineers, Environmental Protection Agency, Coast Guard).

Copies of the United States and South Carolina Codes and Federal and State Regulations can be found in the Department's Legal Office library.

2.1.2 South Carolina Codes and Regulations

2.1.2.1 *Code of Laws of South Carolina*

Authority of the South Carolina Department of Transportation is derived from legislation. Over the years, various State statutes have been enacted that provide the background for administrative and technical controls and procedures that govern the Department. These statutes also establish sources and amounts of funds available to the Department for construction, maintenance and operation of the State Highway System. In certain instances, the Legislature passes laws that establish funds exclusively for a specific program or project. This is the case with the "C" fund law (S.C. Code Section 12-28-274C) which sets aside 2.66 cents per gallon of gas tax revenue for highway projects selected by County Transportation Committees. State laws sometimes are passed to provide necessary recognition and legal structure for the State to implement

Federal laws. Various South Carolina statutes relating to the Interstate Highway System demonstrate this.

The major statutes of the *Code of Laws of South Carolina*, as amended, pertaining to the Department are contained in various volumes and titles of the law. Very general and selected areas of subjects, noted in parenthesis, that are pertinent to the Department are as follows:

- Chapter 5, Title 12, Taxation (e.g., tax amounts, sources and distribution, “C” funds);
- Chapter 2, Title 28, Eminent Domain (e.g., right of way condemnation requirements);
- Chapter 22, Title 40, Professions and Occupations (e.g., engineers and land surveyors practices);
- Chapter 5, Title 56, Motor Vehicles (e.g., regulating traffic; signs, signals, and markings, vehicle sizes and weights);
- Chapter 5, Title 57, Highways, Bridges, and Ferries (e.g., powers of Department, State Highway System, design references); and
- Chapter 5, Title 58, Public Utilities, Services, and Carriers (e.g., utilities, railroads).

2.1.2.2 South Carolina Regulations

To implement the intent of the South Carolina laws applicable to highways and public transportation, the Department uses regulations under the provisions of the *South Carolina Administrative Procedures Act*. These regulations provide the administrative and operational direction for the Department to carry out its duties and responsibilities. The following provides a list of State agencies and their regulations, which may, in whole or in part, apply to SCDOT. These regulations are not necessarily all related to highway design.

- Department of Highways and Public Transportation, 63-300, et seq.;
- S.C. Land Resources Conservation Commission, 72-1, et seq.;
- S.C. Public Service Commission, 103-1, et seq.;
- S.C. Budget and Control Board, 19-101, et seq.;
- S.C. Coastal Council, 30-1, et seq.;
- S.C. Department of Health and Environmental Control, 61-1, et seq.;
- S.C. Water Resources Commissions, 121-1, et seq.;

- S.C. Wildlife and Marine Resources Department, 123.1, et seq.; and
- S.C. Department of Parks, Recreation and Tourism, 133.100, et seq.

2.1.3 United States Code of Laws and Regulations

The principal legislation governing highways is contained in Title 23, Highways, of the *United States Code* (USC), the underlying authority for most of the regulations that govern the Federal Highway Administration. Title 49, Transportation of the USC, and the regulations promulgated there under contain the laws that govern right of way acquisitions and procedures applicable to Federal projects.

As new highway Acts are passed, Title 23 of the USC is amended. The USC contains all Federal laws that have been codified and is amended annually to reflect changes to existing laws and the addition of new provisions. This codification embodies substantive provisions of law that Congress considers permanent which need not be reenacted in each new Highway Act. Each Highway Act specifies which sections of Title 23 are to be amended, repealed or added. Highway Acts are passed periodically when they are needed. A Highway Act establishes programs (e.g., Interstate Program, National Highway System, Bridge Replacement and Rehabilitation Program) by identifying the scope of the problems to be addressed and by establishing the ground rules under which Federal highway funds may be used. These can be changed by subsequent Highway Acts.

The *Code of Federal Regulations* (CFR) contains regulations promulgated by the Federal government to implement Congressional Acts. These regulations provide the procedures necessary to implement the means, methods and procedures required by the law.

2.1.4 Federal Highway Administration Policy and Procedures

Federal regulations applicable to highways are implemented through the Federal Highway Administration (FHWA) and are set forth in 23 CFR.

2.1.5 American Association of State Highway and Transportation Officials

Although not created by Federal statute, the American Association of State Highway and Transportation Officials (AASHTO) is an organization that facilitates the exchanges of information between the US Department of Transportation and the States. It functions as a forum for discussion of current transportation issues of concern and is frequently called upon by Congress to conduct surveys and provide data on transportation issues. AASHTO publishes many technical criteria and specifications

pertinent to the design of highways and bridges. Many of them are adopted, by reference, by SCDOT and the other States' transportation agencies. A major AASHTO publication, used nationally, is *A Policy on Geometric Design of Highways and Streets*. AASHTO revises and updates design publications periodically as new research and technology is developed.

2.1.6 Other Agencies

Directives and regulations issued by other Federal and State agencies influence the design of highways. Other Federal agencies (e.g., US Army Corps of Engineers, US Environmental Protection Agency, US Coast Guard, South Carolina Department of Archives and History, South Carolina Department of Health and Environmental Control) also promulgate regulations that impact highway design.

The National Environmental Policy Act of 1969 (NEPA) is the major Federal legislation governing environmental issues with regard to highway construction. The US Department of Transportation and FHWA promulgates regulations that establish the policies and procedures required for Federal-aid highway projects. Highway design is often influenced by environmental considerations (e.g., wetlands, archeological/historic sites, parks, recreational lands, endangered species habitats). Other Federal agencies have been empowered to issue regulations governing certain environmental concerns. Sections 23 and 40 of the *Code of Federal Regulations* contain the requirements, policies and procedures to be used in determining and processing environmental impacts of Federal-aid highway projects.

2.2 MANAGEMENT RESPONSIBILITIES

In addition to personnel and financial matters, senior management has the responsibility to:

- direct and manage the preconstruction process including setting project priorities,
- insure a quality assurance program, and
- evaluate effectiveness.

2.2.1 Program Management

The preconstruction process is one part of the Department's total highway responsibilities. The number of separate functions that must be coordinated in the preconstruction process to effectively manage the design process requires a planned and systematic procedure. The workflow and individual descriptions for all the inter-related tasks are described in [Chapter 3](#). Highway designers and managers must be aware of their responsibilities in the following design oriented activities:

- identifying project objectives,
- preparing preliminary project design,
- completing Project Planning Report,
- preparing Design Field Review Plans,
- conducting Design Field Reviews,
- completing Right of Way Plans, and
- completing the Final Construction Plans.

The effective management of these specific activities depends heavily on timely coordination within the Preconstruction Division.

2.2.2 Quality Assurance/Quality Control

Quality assurance consists of all planned and systematic actions necessary to provide adequate confidence that a structure, system or component will perform satisfactorily and conform to project requirements.

Quality control consists of specific procedures involved in the quality assurance process. These procedures include planning, coordinating, developing, checking, reviewing and scheduling the work.

The purpose of quality control is to promote project clarity, completeness, accuracy, coordination of documents and constructability (e.g., checklists, independent reviews, use of standard forms and guidelines). However, quality is not the responsibility of a

single Group or Unit, as it requires the total involvement of every employee of the Department. For additional information on SCDOT's quality control and quality assurance regulations, see the SCDOT website.

2.2.3 Evaluation

Management needs to evaluate how effective their policies and procedures are in meeting program goals and objectives. Project delays, increased costs, reworked plans, construction change orders, personnel morale and productivity are all measures of the effectiveness of the management process. Each level of project supervision plays an important role.

Direction and control of programs are the responsibility of management. Constant monitoring to assure that "actual" results are consistent with "planned" results is a key to the evaluation. When it is found that the results are not in compliance with the planned program objectives, the implementation of immediate corrective action by management is critical.

2.3 ENGINEERING MEMORANDA

2.3.1 Engineering Policy Memoranda

The State Highway Engineer issues Engineering Policy Memoranda (EPM's), as necessary. These EPM's constitute Department policy and compliance unless the State Highway Engineer authorizes variance. The Executive Assistant to the State Highway Engineer is responsible for printing and distributing the Engineering Policy and Directive Memoranda as well as maintaining a file for all original memoranda. Copies of the current EPM's may also be obtained from the SCDOT Intranet website.

Current EPM's relating to highway design are integrated into the various chapters of this *Manual*, as deemed appropriate. New design EPM's become additions and/or modifications to the *Manual* through the established change procedure.

2.3.2 Engineering Directive Memoranda

The Engineering Directors and the State Highway Engineer issue Engineering Directive Memoranda (EDM's), as appropriate. The EDM's are guidelines outlining the procedures to implement the EPM's, but are not inclusive of the official policy. Typically, the State Highway Engineer develops and issues general EDM's, while the Engineering Directors are responsible for specific EDM's according to their Division.

EDM's are systematically categorized by Division and consecutively numbered. The reference numbers are as shown in [Figure 2.3A](#).

Category	Number	Responsible Party
General	G-1,2,3,...	State Highway Engineer
Construction	C-1,2,3,...	Director of Construction
Maintenance	M-1,2,3,...	Director of Maintenance
Preconstruction	PC-1,2,3,...	Director of Preconstruction
Planning	PL-1,2,3,...	Director of Planning
Traffic	T-1,2,3,...	Director of Traffic Engineering

ENGINEERING DIRECTIVE MEMORANDUM

Figure 2.3A

2.3.3 Instructional Bulletins

The Road Design Section publishes Instructional Bulletins. The purpose of Instructional Bulletins is to provide information on specific design issues (e.g., trench drain applications, guidelines for hot mix asphalt selection, property identification in plans). The Instructional Bulletins are consecutively numbered and referenced by the year in which they are published (e.g., Instructional Bulletin No. 2002-1, Trench Drain Applications).

Copies of Instructional Bulletins may be obtained from SCDOT's Internet website.

2.3.4 Other Instructional Bulletins

The following Sections may publish Instructional Bulletins that may be helpful to the road designer:

- Bridge Design Section,
- Hydraulic Engineering Section,
- Right of Way Office,
- Traffic Engineering Division,
- Maintenance Division,
- Construction Division, and
- Program Development Section.

Copies of these Instructional Bulletins may be obtained from the SCDOT Internet website.

2.4 PARTICIPATION AGREEMENTS

2.4.1 Purpose

Generally, the Department will manage highway construction or maintenance activities on the State Highway System. However, counties, municipalities or agencies acting on behalf of a County Transportation Committee may enter into agreements with the Department to construct and/or maintain State highways or roads if the Department has given explicit authority to do so. In this case, the local agency must show that it has the equipment, staff and financing to satisfy the Department's requirements.

Conversely, road construction projects on the State Highway System that are funded entirely by the local agency (i.e., do not receive any State or Federal financing) may be performed under the supervision and approval of the Department, if requested by the local agency and provided an agreement can be reached.

Any local highway construction or maintenance project that receives Federal funding through the State must be supervised and approved by the Department and requires an agreement.

Typically, the Contract Audit Service, Legal and Right of Way Offices are responsible for writing agreements with the appropriate Program Manager's input. Topics that are generally addressed include:

- enhancements,
- sidewalks,
- signals,
- lighting,
- roadway,
- bridges,
- storm sewers,
- bicycle paths, and
- ditches.

2.4.2 Application

An Agreement is required when local funds are involved in projects financed in part with State and/or Federal funds, and when one or more of the following conditions apply:

- improvements on the local highway system for which construction, engineering, utility relocation and/or right of way acquisition is paid totally, or in part, with State or Federal funds;

- improvements on the State Highway System in which the local agency is participating in the cost and/or any subsequent maintenance on any phase of the improvement or in utility and/or maintenance costs of traffic signals or street lighting;
- improvements on the State or local highway system involving a jurisdictional transfer between the State and the local agency;
- a municipality proposed to improve a municipal street extension which extends into another municipality;
- any highway authority proposing to transfer jurisdiction of a highway or street to another highway authority;
- any highway authority proposing to utilize “C” funds for participation in a joint improvement with another highway authority;
- any highway authority proposing to utilize “C” funds to pay another highway authority to perform maintenance on highways or streets that are the responsibility of the first highway authority; and
- where there are Agreements with private entities (e.g., developers, corporations).

2.4.3 Content

Agreements between the Department and a local agency are typically provided for maintenance and construction. The Department and the local agency must enter into an Agreement that insures funds are expended in accordance with State law. The Agreement should, where applicable include the following:

- the Department will make periodic inspections of the project, as it deems necessary, to satisfy that the work is being done in compliance with the plans, specifications, and Department policies and procedures;
- the provisions of the Agreement that do not apply to any Federal or State funded projects that are not administered under the “C” Program’s policies and procedures;
- the Agreement may be terminated at the discretion of either party; and
- the use of “C” funds, other than specified in the Agreement, will require approval by the Department.

2.4.4 Responsibilities

The Agreement must clearly identify the responsibilities of each party and other items pertinent to a clear understanding between the parties relative to the project (e.g., description of work, funding responsibilities, maintenance responsibilities).

However, in some cases, the local agencies or private concerns perform maintenance work that is the State's responsibility under the terms of a request for proposals (RFP) or request for bid (RFB) agreement. Agreements typically address issues pertaining to:

- signals,
- parking,
- sidewalks,
- lighting,
- bicycle paths, and
- ditches.

For more detailed information on Participation Agreements, see SCDOT's Departmental Directive Number 32, which addresses the procedures for developing, executing, routing, filing and closing Participation Agreements.

2.5 PUBLIC INVOLVEMENT

2.5.1 Introduction

The procedures in this section are intended to provide an overview of effective public participation and consideration for highway location and design proposals. In general, they provide for free and open discussion of project alternatives to encourage early resolution of controversial issues. The procedures also reflect coordination with other public agencies, private organizations and individuals. The public involvement process insures that potential adverse economic, social and environmental effects are fully considered in project development. This should result in final decisions that reflect the best overall public interest in providing safe, economic and efficient transportation with minimal adverse effects.

2.5.2 Types of Public Involvement

Public involvement activities may utilize a number of formats in providing information to the public and receiving public input. By varying the format, the public may be involved individually in an informal atmosphere, in listening to formal presentations of information, and in making comments for the record at a public hearing. Some of the formats provide for more than one of these relationships. The Program Manager should select the format for an activity according to the situation. Many people prefer an individual contact that will not require speaking before large groups. The following Sections provide a description of several acceptable formats.

2.5.2.1 Workshops/Partnering

Workshops are meetings where participants are given basic transportation requirements, economic and design constraints, and anticipated social, economic and environmental impacts all related to a proposed project or project problem, and are then asked to study the problem and suggest a solution. In a workshop format, participants are requested to analyze the provided information, identify impacts that may have been overlooked, work with others with whom they may agree or disagree and offer solutions and explanations on their suggestions.

Workshops provide an opportunity for the public to experience the complexities and problems that confront the Department personnel during project development. This enhances public understanding and appreciation of the Department effort. Because the public will be analyzing pertinent information and suggesting solutions to problems and indicating preferences among impacts and tradeoffs, a sense of existing local values and preferred mitigation measures may be gained.

2.5.2.2 Informational Meetings

Informational meetings are informal public gatherings that blend the individual discussions of open houses with the group interaction of public hearings. They include an individual discussion period characteristic of an open house. Generally, a transcript of the meeting is not recorded.

Informational meetings provide an opportunity to assemble a large group at one time to discuss the status of the project, the decisions made to date, the options yet to be decided and the criteria considered critical for the remaining decisions.

Group briefings and information exchanges are additional types of public involvement that may be used when designing a public involvement activity.

2.5.2.3 Informal Public Hearings

It is necessary to have appropriate Department representatives present, to provide explanatory project information, to provide for the receipt of oral and written statements, and to prepare a summary of the proceedings. The informal public hearing format provides for a continuous flow of visitors over a period of hours in contrast to a formal public hearing that attracts a large crowd at a fixed time. The smaller number of visitors present at any given time at an informal public hearing allows personalized service through staff discussions with individuals. Surveys of participants in public activities for SCDOT highway projects have indicated that the informal public hearing format is generally viewed more favorably than the more formal format. The informal hearing format is less intimidating to participants and offers a more workable option for conducting hearings for very large audiences. FHWA has recognized the benefits of this format and encourages its use as an effective public involvement method that meets the hearing requirements of the *US Code of Federal Regulations*.

2.5.2.4 Formal Public Hearings

This format generally has a speaker addressing a large audience. Members of the audience in turn have an opportunity to address the speaker. Because of the size of the audience, the program must be structured allowing for very little informal exchange of information. This format does not allow for as much personal attention to be paid to individuals.

2.5.3 Coordination

2.5.3.1 General

During the development of a proposed highway project, the Department often must coordinate with a variety of resource agencies. Many of these contacts are informal and are only intended to discuss certain aspects of upcoming highway projects (e.g., potential effects of the project on specific resources, cost participation by local agencies associated with a State highway project that affects local-system facilities). Notices of upcoming public involvement activities afford another mechanism for agencies to obtain information on proposed projects. All of these actions contribute to interagency coordination.

2.5.3.2 Project Coordination Meetings

The Program Manager/designer conducts periodic coordination meetings that may involve personnel from the Department, FHWA and other agencies, as appropriate. The goal is to coordinate planning; identify social, economic and environmental impacts; minimize these impacts through mitigation; and develop the best overall solution to satisfy the transportation needs.

2.5.4 Public Involvement Program Requirements

2.5.4.1 Federal and State

For the purpose of determining the need for the holding or offering of a public hearing on proposed projects, Section 128 of Title 23 of the *US Code* is defined to mean that a public hearing shall be held or offered on all projects that involve the relocation of an existing marked route on the State Highway System through or around any city, town or village. This is interpreted as requiring the holding or offering of a public hearing on projects such as:

- a new bypass around a community,
- a new route going through a community,
- the relocation of an existing route from one street to another which did not previously carry route traffic (with or without additional right of way),
- changing to a one-way couple which will use a street that did not previously carry route traffic (with or without additional right of way), and

- the reconstruction of an existing route with additional through traffic lanes through town (included because a reasonable alternative would be a bypass or one-way couple).

Projects such as the following do not require the holding or offering of a public hearing pursuant to 23 USC 128:

- upgrading an existing route to current design criteria for 20-year traffic including the acquisition of additional right of way, but not including additional through traffic lanes;
- intersection improvements including signals, throat widening, adding turn lanes and other channelization;
- widening less than a one-lane width and resurfacing, with or without additional right of way;
- changing from open ditches to closed drainage; and/or
- projects in rural areas which do not pass through or bypass a city, town or village.

Department policy is to provide all interested persons an opportunity to become acquainted with highway proposals of concern to them and to express their views at those stages of a proposed development when the flexibility to respond to those views still exists. Accordingly, SCDOT may require public involvement activities in addition to the holding or offering of public hearings on Federal-aid projects.

2.5.4.2 FHWA Environmental Regulations

In accordance with the FHWA Regulations on Environmental and Related Procedures (23 CFR 771), the Department will hold one or more public hearings or offer the opportunity for hearing(s) to be held at a convenient time and place for any Federal-aid project which:

- requires significant amounts of right of way;
- substantially changes the layout or functions of connecting roadways or of the facility being improved; or
- has a substantial adverse impact on abutting property, otherwise has a significant social, economic, environmental or other effect or for which FHWA determines that a public hearing is in the public interest.

When a program or series of projects will be initiated in a general locality, providing some advance notice can avert much of the controversy and a public forum for the citizenry to receive information about the projects and to comment where appropriate. An effective public involvement program can consolidate overall public support and contribute significantly to the successful completion of projects with the additional benefit of a positive attitude towards the Department.

2.6 CONSULTANT PROJECT PROCEDURES

2.6.1 Construction and Resource Management Program

The Construction and Resource Management (CRM) Program is a public-private partnership aimed at completing 27 years worth of road and bridge work in 7 years as part of SCDOT's accelerated construction program.

The Department has contractual agreements with Consultants that have extensive experience in highway and bridge design. Each is assigned to a region of the State (i.e., east and west regions) and helps manage SCDOT highway projects. The two CRM firms act as extensions of the Department and assist the SCDOT Program Managers with tasks from program management, financial management and design to construction management, engineering and inspection. The SCDOT Program Manager will continue to oversee each project.

2.6.2 Consultants

2.6.2.1 General

Consultants are used to assist in the development of projects for different divisions of SCDOT. Each division is responsible for all administrative aspects of Consultant-designed projects, including those under a term contract. This includes:

- advertising for Consultant services,
- preparing the Request for Proposals,
- administering the Consultant evaluation and selection process,
- conducting contract negotiations with the selected Consultant,
- processing and executing the agreement,
- processing Consultant payments,
- processing Supplemental Agreements,
- monitoring project progress,
- resolving disputes, and
- closing out the Agreement.

2.6.2.2 Project Implementation

The following discusses the typical activities that occur during the implementation of a Consultant-designed project:

1. Scoping of Consultant Services. A meeting will typically be held to identify a preliminary project scope of work for the Consultant. This meeting will allow the

development of an appropriate Request for Proposal (RFP) or to clarify the Consultant's scope of work. A field review may or may not be required to determine the appropriate scope of work.

2. Orientation Meeting. The official Notice to Proceed provides the Consultant with the authority to begin work on the project. However, before initiating the project work, it is desirable to hold a Scoping Meeting with the Consultant, especially if the Consultant is not familiar with Department procedures. The Meeting should be held as soon as possible after the Notice to Proceed is issued. Representatives from the Bridge Design Section, Road Design Section, Environmental Management Office, other Department staff with an interest in the project, and the Consultant's Project Manager and key staff should attend this meeting.

The objectives of the Orientation Meeting are to:

- introduce the Department and Consultant project team members to one another;
 - determine the lines of communication (e.g., clearly establish the principal contacts for both the Department and the Consultant on technical and administrative issues);
 - review project objectives, critical design issues, and any Federal, State or local requirements that will impact the project;
 - review the Department's requirements for technical reviews, quality control, progress reporting and invoicing;
 - discuss the procedures for conflict resolution; and
 - review the Consultant's detailed work plan and schedule.
3. Project Schedule. To effectively monitor project progress, there must be a clear definition of the project scope of work. Based on the scope, the Consultant should have developed a realistic and detailed work plan and schedule to guide the project development process for both the Department and the Consultant. With this initial schedule as a baseline, monthly progress can be monitored and compared with the baseline. Unforeseen circumstances will cause the progress to move ahead or fall behind the original plan, but routine delays that are often encountered should be anticipated with some allowances built into the schedule to accommodate them.

The Consultant should prepare a detailed schedule for the project, using the agreed upon contract dates for key events as the control points for the schedule.

The schedule should clearly define activities and events to be performed by the Department and the Consultant. If reviews by other SCDOT Units or outside agencies are required, these should also be anticipated and scheduled. The schedule should be presented for review at the Scoping Meeting. This schedule should be used to monitor project progress throughout project implementation.

If SCDOT and/or the Consultant determine that the project is behind schedule, the reason should be determined. If the delay is within the Consultant's control, the Department should request in writing a plan from the Consultant to get the project back on schedule. If the delay is the Department's responsibility or for circumstances beyond the Consultant's control, it should determine what, if anything, can be done to expedite the project. If the schedule delay is of sufficient magnitude that the contract completion date is not likely to be met, the Consultant should request a time extension with an explanation of the circumstances necessitating the extension.

4. Monthly Progress Reports. The Consultant must submit a written progress report at intervals as specified in the contract. Normally, progress reports are required for each month of the contract period, whether or not any progress has occurred. The progress report should be clearly identified as such and should contain:
 - a. Project Identification. Include Project Name, Project Number and Contract Number.
 - b. Reporting Period. Identify the month or period covered by the report.
 - c. Narrative Discussion of Project Status. Provide the following:
 - discussion of work accomplished since the last progress report,
 - discussion of work to be accomplished by the next progress report, and
 - description of any major outstanding issues or concerns.
 - d. Percent Complete. Show percent complete by activity as labor expended and/or dollar value earned, depending on type of contract:
 - Lump-sum contracts — percent of dollar value earned by activity, and
 - Cost-plus contracts — percent of labor-hours expended by activity.
 - e. Project Schedule. State the status of the project progress relative to the approved Project Schedule.
5. Department Reviews. In general, the Consultant is responsible for the accuracy and quality control of its work products.

The Consultant will submit all work products to the Department for review and comment. In addition, on an as-needed basis, periodic review meetings will be scheduled with the Consultant. The objectives of the meetings may include answering Department questions, resolving Department comments, assessing project progress, etc. After the meeting, the Consultant will be responsible for preparing minutes to document the key decisions made during the meeting.

6. Scope of Work Changes. When significant changes occur in the scope, character or complexity of the project work, a Supplemental Agreement may be negotiated if it is mutually agreed that such changes are necessary. The Consultant will document the revised scope of work and prepare a cost estimate for review and approval by the Department. If the change in scope is approved, a Supplemental Agreement will be processed.

A claim for extra work will only be accepted when a change of scope has been approved.

7. Final Acceptance of Work. After the Consultant has completed all work required by the contract, the Consultant will submit a letter to the Department stating that the project work has been completed and requesting final acceptance of the work from the Department. If in agreement, the Department will prepare the Final Acceptance letter to the Consultant.

2.7 VALUE ENGINEERING

Designers should acquaint themselves with value engineering (VE) objectives and methods, as savings can be achieved in the design phase by using VE techniques.

The basic principle of VE encourages the design of cost effective projects and may include the substitution of alternative designs, materials and/or innovative construction methods. The following are elements of a VE program:

- a commitment of resources and support by management;
- all levels of management must understand and support the concept of VE;
- a policy directive describing details of a State VE program;
- a VE training program for all levels of management;
- a VE coordinator position that administers and monitors the State's VE program;
- A VE program should be administered:
 - + early in the planning-design process to maximize the potential product improvement and cost savings,
 - + on high-cost and complex projects, and
 - + by a multi-discipline team of professionals trained in VE techniques;
- all recommendations must be fairly evaluated for implementation; and
- the VE programs within the State organization should be closely monitored, evaluated and modified to assure the program's effectiveness.

In addition to VE during preconstruction, SCDOT also encourages VE during the construction. This allows the Department to benefit from a contractor's design and construction ingenuity, experience and ability to work through or around restrictions.

2.8 REFERENCES

1. *Code of Laws of South Carolina* (1976), as amended (Volumes 5, 10, 14, 18, 19).
2. *United States Code of Laws*; Title 23, Highways, as amended and related *Codes of Federal Regulations*.
3. *United States Code of Laws*; Title 49, Transportation, as amended and related *Codes of Federal Regulations*.
4. *United States Code of Laws*; Title 42, National Environmental Policy Act of 1969, as amended and related *Code of Federal Regulations*.
5. American Association of State Highway and Transportation Officials (AASHTO); various Manuals, Standards, Specifications, Guidelines (current editions).

TABLE OF CONTENTS

<u>Section</u>	<u>Page</u>
3.1 GENERAL	3.1(1)
Task 01: Initiate Project	3.1(5)
Task 02: Prepare Program Action Request (PAR).....	3.1(6)
Task 03: Setup Project and Determine Funding	3.1(7)
Task 04: Prepare Project Concept.....	3.1(8)
Task 05: Conduct Survey.....	3.1(9)
Task 06: Obtain Traffic Data/Input.....	3.1(10)
Task 07: Assign Project to Design Group	3.1(11)
Task 08: Prepare Preliminary Design	3.1(12)
Task 09: Begin Design Field Review Plans	3.1(13)
Task 10: Complete Design Field Review Plans	3.1(14)
Task 11: Prepare Pavement Design	3.1(15)
Task 12: Conduct Bridge Type, Structure and Layout Studies	3.1(16)
Task 13: Prepare Hydraulic and Hydrologic Designs.....	3.1(17)
Task 14: Begin Utility Coordination Process	3.1(18)
Task 15: Conduct Design Field Review	3.1(19)
Task 16: Begin Environmental Process	3.1(20)
Task 17: Begin Right of Way Plans	3.1(21)
Task 18: Perform Constructability Review	3.1(22)
Task 19: Complete Environment Document	3.1(23)
Task 20: Finalize Right of Way Plans	3.1(24)
Task 21: Prepare Roadway Structures Plans	3.1(25)
Task 22: Acquire Right of Way	3.1(26)
Task 23: Implement Railroad Coordination Process.....	3.1(27)
Task 24: Continue Utility Coordination Process.....	3.1(28)
Task 25: Secure Permits.....	3.1(29)
Task 26: Develop Final Construction Plans	3.1(30)
Task 27: Prepare Traffic Engineering Plans	3.1(31)
Task 28: Prepare Bridge Plans	3.1(32)
Task 29: Complete Right of Way Acquisition and Local Agreements ...	3.1(33)
Task 30: Assemble Construction Plans	3.1(34)
Task 31: Conduct Final Plan Review/Corrections/Obtain Signatures ...	3.1(35)
Task 32: Process Plans for Letting	3.1(36)
Task 33: Conduct Letting.....	3.1(37)

Chapter Three

PROJECT DEVELOPMENT PROCESS

This Chapter documents the basic approach used by SCDOT in its project development process for projects on new and existing alignment. It presents the process graphically in order to illustrate the development of typical highway projects and identify the significant tasks necessary to develop a set of roadway construction plans.

3.1 GENERAL

[Figure 3.1A](#) presents a network or flowchart that graphically illustrates the general project development process. Following the figure is a brief description of each task within the network. When using this network, consider the following:

1. Precedence Task Network. The network or flowchart is a precedence task network. A “task” occurs when a significant, discrete event occurs and/or when the responsibility for the project (task) is transferred from one Unit to another. The “precedence” nature of the network implies that a task cannot occur until all tasks preceding that one have been completed. However, the user must be aware that some flexibility is necessary to apply this network to project development.
2. Project Application. This network represents an approximate process for a relatively complicated roadway project on new alignment or major reconstruction project. Not every task will be applicable to every project and not all tasks are shown. With adjustments, the network can also be used for minor reconstruction, 3R and “C” projects.

The illustrated network assumes the project is designed in-house. The process for a consultant-designed project will be similar, except that communication lines exist between SCDOT and the consultant for SCDOT review and approval. For additional guidance on consultant project procedures, see [Section 2.6](#).

3. Lines of Communication. The rigid application of the network would lead to predetermined, precise points at which communication occurs between Units. This is neither realistic nor desirable. Communication between Units must be continuous. This will result in fewer problems and fewer “surprises” in project development.

4. Other Manual Chapters. The SCDOT *Highway Design Manual* contains several other chapters that provide complementary information to Chapter 3. The designer should review these chapters for more information on the project development process. In particular, Chapter 3 should be used in combination with Chapter 4 “Road Design Coordination,” Chapter 5 “Utility Coordination,” Chapter 6 “Railroad Coordination,” Chapter 26 “Surveys,” Chapter 27 “Environmental Procedures,” Chapter 28 “Traffic Control Devices,” Chapter 29 “Drainage” and Chapter 30 “Right of Way.”

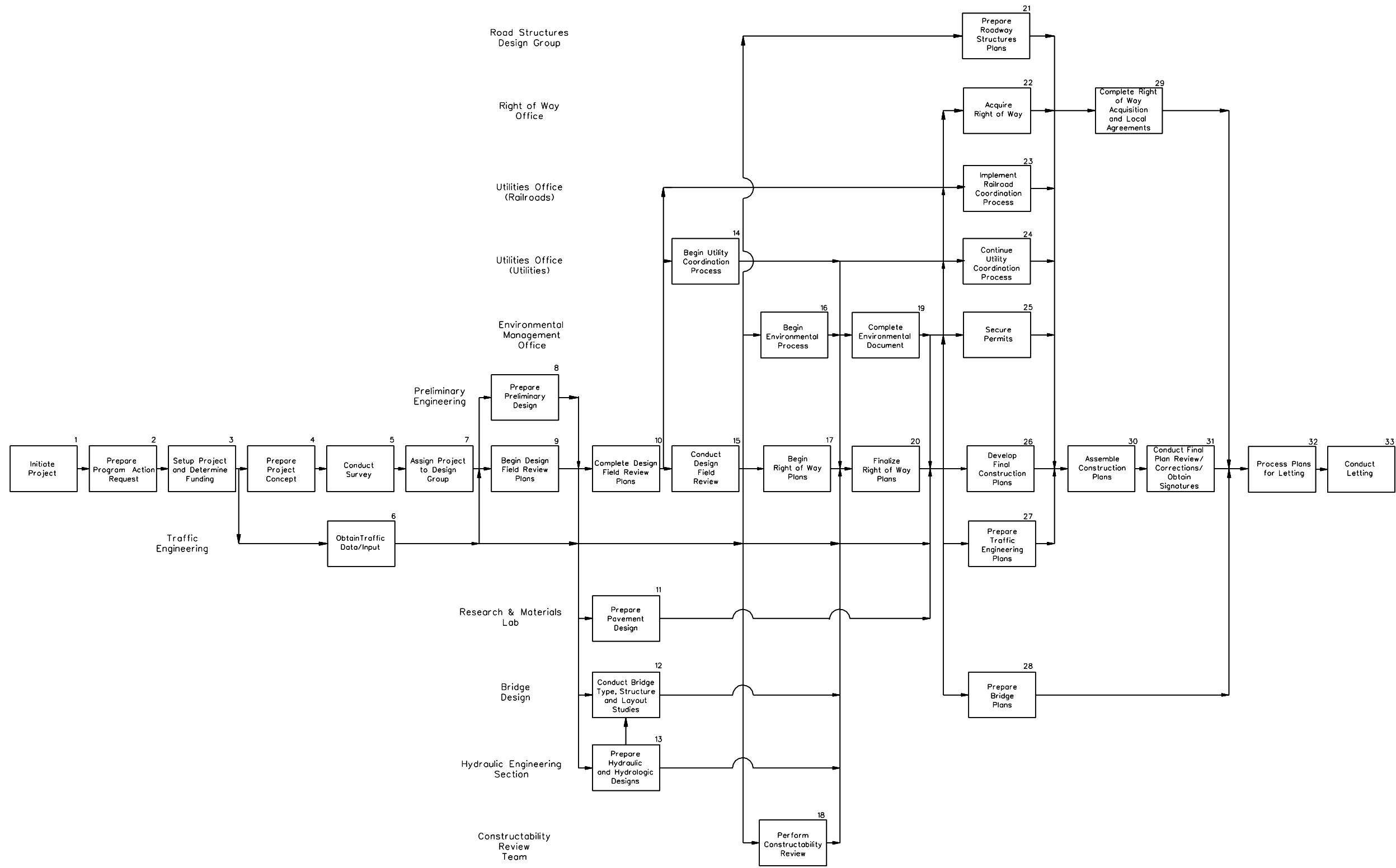

PROJECT DEVELOPMENT NETWORK

Figure 3.1A

PROJECT TASK

Task Title: Initiate Project

Task No.: 1

Responsible Unit: Program Development Section

Task Description:

A roadway project proposal can originate from a variety of sources, including local officials, county transportation commissions, council of governments (COG) or metropolitan planning organizations (MPO) (community-based need); directly from the SCDOT District Office (district-based need); from a Section/Division within the Central Office (e.g., Preconstruction, Traffic Engineering Division, Planning Division); or from management systems (e.g., Traffic Safety, Bridge Replacement Program) targeting a special or statewide need.

Once a project request is received, a Program Manager will be assigned to the project. The Program Manager will develop a Multidisciplinary Team to review the project. The Multidisciplinary Team may include individuals from the Road Design Section, Bridge Design Section, Surveys Office, Hydraulic Engineering Section, Environmental Management Office, Utilities Office, Right of Way Office, Traffic Engineering Division, Cost Estimating and Value Engineering Group, Construction Division, District Engineering Offices, FHWA, and/or MPO/COG or other local officials. The number and expertise of personnel initially assigned to the Multidisciplinary Team will vary with the nature and scope of the proposed improvement. For example, if the project is identified in SCDOT's Beautification Plan or if landscaping is an early requirement, a representative from the Beautification Office is included in the initial project review. The personnel assigned will also vary over time relative to the priority for completion, the available lead-time and the task in project development under study.

The Multidisciplinary Team develops and documents the project concept. This will typically involve the following:

- determining if there is an actual need for the project;
- identifying the project's characteristics requiring improvement, termini and length;
- making a preliminary determination of the project scope of work;
- reviewing any available data and records;
- conducting an initial evaluation of the project's geometric design, right of way, utilities, hydraulics, bridge and environmental requirements;
- developing a rough, preliminary cost estimate;
- determining a proposed schedule; and
- conducting an office and/or field review.

PROJECT TASK

Task Title: Prepare Program Action Request (PAR)

Task No.: 2

Responsible Unit: Program Development Section

Task Description:

Once the Multidisciplinary Team completes its review and recommendations, the Program Manager prepares and submits candidate projects as a request for project approval to the Director of Preconstruction. The project information in the PAR includes:

- road and route number,
- county name,
- city or transportation study area,
- project length,
- local name,
- general description of road and/or bridge work,
- basic cross section,
- present and future traffic volumes,
- nature of the request for action,
- project obligation and funding information, and
- location map.

Note that for road improvement projects the responsible Unit for preparing the PAR is the Program Development Office. However, depending on the type of project, the responsible Unit may be different (e.g., Bridge Design Section for bridge projects, Traffic Engineering Division for spot improvement projects).

Once the PAR is completed, the Program Manager forwards it to the Director of Preconstruction for approval.

PROJECT TASK

Task Title: Setup Project and Determine Funding

Task No.: 3

Responsible Unit: Preconstruction Management Section

Task Description:

After receiving the Director of Preconstruction's approval ([Task 2](#)), the Program Manager forwards the project request to the Preconstruction Management Section. The Preconstruction Management Section will verify that the project is in the Department's State Transportation Improvement Program (STIP).

The Preconstruction Management Office is responsible for setting up the following project identifiers:

- preliminary engineering charge code,
- project and reference number,
- funding program, and
- State file number.

Based on a statewide assessment of highway improvement needs and available funds, the Preconstruction Management Office will determine the appropriate funding category for the project. This may be Federal funds, C-funds or other State funds. If Federal funds are used, the Federal-aid Unit will request FHWA's approval for the project. For additional guidance on funding sources, see [Chapter 7](#).

Once funding for the preliminary engineering has been approved, this establishes an individual project as an active project for further development. The Preconstruction Management Section will setup the project on the Department's Preconstruction Project Management System.

PROJECT TASK

Task Title: Prepare Project Concept

Task No.: 4

Responsible Unit: Project Development Team

Task Description:

Based on the initial project review ([Task 1](#)), the Program Manager begins the process of developing the Project Planning Report. This includes establishing a Project Development Team. Team members generally are from the Units discussed in [Task 1](#). Task 4 will typically consist of the following actions:

1. The Project Development Team will conduct a comprehensive field review, including a thorough review of the project survey and Subsurface Utility Engineering (SUE) requirements.
2. The Program Manager will:
 - Identify areas that may need geotechnical data to facilitate design.
 - Prepare project-specific portion of the eminent domain ad and submit it along with the PIN and charge code to the Environmental Management Office.
 - Prepare and submit requests for crash summary and reports.
 - Request traffic data and analyses.
 - Request pavement loading and turning movements for significant intersections.
3. The Environmental Management Office will complete the preparation of the eminent domain ad and submit it for advertisement.
4. The Preliminary Design Group will prepare the survey and SUE request. This information will be used to conduct [Task 5](#).
5. In areas needing geotechnical study, the appropriate Section (e.g., Road Design Section, Bridge Design Section) will request soil borings from the Research and Materials Laboratory.

PROJECT TASK

Task Title: Conduct Survey

Task No.: 5

Responsible Unit: Surveys Office

Task Description:

The work associated with the field survey begins when the Surveys Office receives the Request for Survey ([Task 4](#)). The Surveys Office conducts the field survey and prepares notes, drawings and recommendations for existing field conditions, drainage systems, utility lines, and right of way and their relative positions and elevations. The Office will select and contract with a SUE consultant, when requested.

The Surveys Office places the survey information into CADD for the Project Development Team's use. The following describes some of the information provided by the field survey:

1. Existing Field Conditions. The Survey Crew records any topographic feature that will influence or be influenced by the project design. This would include existing structures, barriers, highway facilities, vegetation and concrete work.
2. Drainage Systems. The drainage considerations include any bodies of water, open channels or pipe systems.
3. Utilities. The utility information consists of the location and ownership of all railroads, power lines, substations, pipelines, etc., above and below ground. This includes the results from a SUE consultant, when requested.
4. Right of Way. The Survey Crew researches and documents ownership of property, existing right of way, property boundaries, property ownership and entrances to property.

As the project design evolves, additional surveys may be required as design needs change and/or where field conditions cannot always be anticipated.

For further guidance on surveys, see [Chapter 26](#).

PROJECT TASK

Task Title: Obtain Traffic Data/Input

Task No.: 6

Responsible Unit: Traffic Engineering Division

Task Description:

Upon request by the Program Manager ([Task 3](#)), the Traffic Engineering Division will begin the process of obtaining the necessary traffic data for the project.

The Traffic Engineering Division is responsible for the collection, analysis and reporting of traffic statistical data, highway capacity analysis, crash data, roadway geometric inventory, local road inventory, highway performance and road life history.

The Traffic Engineering Division will also perform an intersection analysis on all significant intersections.

The Traffic Engineering Division will obtain traffic projections from the Planning Division.

The Traffic Engineering Division will forward this data to the Preliminary Design Group and Road Design Group. The Preliminary Design Group and Road Design Group will use this data to prepare Design Field Review Plans ([Task 9](#)). Additional traffic data will be used by the Road Design Group to prepare the Final Construction Plans ([Task 26](#)).

PROJECT TASK

Task Title: Assign Project to Design Group

Task No.: 7

Responsible Unit: Road Design Operations Center

Task Description:

The Surveys Office will forward the survey information ([Task 5](#)) to the Operations Center in the Road Design Section. The Operations Center will assign the project to a Road Design Group considering the Group's existing work load, expertise, experience, etc.

PROJECT TASK

Task Title: Prepare Preliminary Design

Task No.: 8

Responsible Unit: Preliminary Design Group

Task Description:

After receiving the survey information ([Task 5](#)) and traffic data ([Task 6](#)), the Preliminary Design Group will determine the major design elements for the project. This will include a determination of the following:

- horizontal and vertical alignment;
- intersection details (e.g., left/right-turn lane lengths, channelization, curb return radii, corner sight distance);
- interchange details (e.g., lengths of acceleration/deceleration lanes, ramp designs);
- design of median openings;
- roadside clear zone;
- sidewalk width;
- impacts on existing utilities;
- approximate construction limits; and
- any potential design exceptions.

In addition to setting the major design elements, the Preliminary Design Group will distribute the Preliminary Design Plans for review and comment to the following:

- all members of the Project Development Team;
- the Bicycle/Pedestrian Coordinator for review and recommendation of bicycle and pedestrian access and design criteria;
- the Beautification Office for review and recommendation of possible areas required for beautification or landscaping (on selected projects);
- the Value Engineering and Cost Estimating Group for projects requiring alternative preliminary designs and for projects programmed with NHS funds in excess of \$25 million; and
- the Program Manager, who will submit them to COG/MPO and any other local non-SCDOT Team Member, where appropriate.

The Preliminary Design Group will schedule and conduct, as necessary, an in-house and/or field review of the proposed preliminary design.

PROJECT TASK

Task Title: Begin Design Field Review Plans

Task No.: 9

Responsible Unit: Road Design Group

Task Description:

After reviewing the initial documents received from the Project Development Team ([Task 4](#)) and survey information ([Task 5](#)), the Road Design Group will perform the following:

- plot the existing topography and determine the plan sheet layout;
- prepare the preliminary Typical Section Sheets;
- submit Typical Section Sheets to the Pavement Design Engineer in the Research and Materials Laboratory verifying the proposed pavement design ([Task 11](#));
- where applicable, provide the Bridge Design Section with the proposed elevation layouts so that the Bridge Design Section can begin the Bridge Type, Structure and Layout Studies ([Task 12](#)); and
- continue to gather and assemble project data.

In addition, the following actions will occur during this task:

- The Program Manager will decide whether to require Fee Simple right of way or Slope Permission for the construction slopes.
- The Value Engineering and Cost Estimating Group will update the cost estimate.

PROJECT TASK

Task Title: Complete Design Field Review Plans

Task No.: 10

Responsible Unit: Road Design Group

Task Description:

After receiving the design information from the Preliminary Design Group ([Task 8](#)), the Road Design Group will place the preliminary design onto the existing topography and complete the Design Field Review Plans. These plans are used to perform the Design Field Review ([Task 15](#)).

The Road Design Group will inform the Utilities Office of any potential utility and railroad involvement.

PROJECT TASK

Task Title: Prepare Pavement Design

Task No.: 11

Responsible Unit: Pavement Design Engineer

Task Description:

Based on the information provided by the Road Design Group ([Task 9](#)), the Pavement Design Engineer within the Research and Materials Laboratory will perform the detailed pavement design analysis. The analysis is based on a soils investigation and a traffic analysis.

The Research and Materials Laboratory conducts the soils investigation and recommends a soil support value for the most typical soil type. The soil support value indicates the loading that the soil can support. The Traffic Engineering Division conducts the traffic analysis for the proposed project and provides data pertinent to pavement design (e.g., average daily traffic estimates at five year intervals, estimated percentage of ADT's for truck traffic, expected loading for the design life). The objectives of these analyses will be to:

- select the design methodology, pavement type and design criteria;
- determine the overall pavement thickness and thicknesses of individual layers; and
- determine any special surfacing design features (e.g., high-stress intersections, subdrainage design, use of geotextiles).

The final pavement design is submitted to the Program Manager and the Road Design Group. The final pavement design is used by the Road Design Group to develop the Final Construction Plans ([Task 26](#)).

PROJECT TASK

Task Title: Conduct Bridge Type, Structure and Layout Studies

Task No.: 12

Responsible Unit: Bridge Design Section

Task Description:

Once the Road Design Group and Preliminary Design Group determine the general roadway alignment and elevations ([Tasks 8](#) and [9](#)), the Road Design Group forwards this information to the Bridge Design Section. At this point, the Bridge Design Section can begin preparing the Bridge Type, Structure and Layout Studies for any bridges within the project limits. These studies are used to develop the detailed Bridge Plans. The studies will present the following:

- plan and profile of the bridge showing the proposed type of superstructure and foundations, bridge and elevations, location of expansion and fixed ends, highway approaches and existing contours at the bridge site;
- superstructure cross section showing pertinent structural details (e.g., number of beams, depth and width of bridge deck);
- bridge curb, sidewalk and/or shoulders;
- design loadings, stresses, specifications and other structural criteria;
- controlling horizontal and vertical clearances;
- hydraulic data, high- and low-water elevations, etc.; and
- a small scale location map to identify the location of the proposed bridge.

The Bridge Design Section forwards this information to the Road Design Group to complete the final Right of Way Plans ([Task 20](#)).

PROJECT TASK

Task Title: Prepare Hydraulic and Hydrologic Designs

Task No.: 13

Responsible Unit: Hydraulic Engineering Section

Task Description:

This Task is concerned with 1) the disposal of water collecting on the roadway, without flooding or damaging the highway or adjacent areas and 2) drainage flowing across the highway right of way. Unless the storm runoff is properly controlled, severe erosion of the roadway and slopes may create a costly maintenance problem or driving hazard. To prepare the project drainage design, the Hydraulic Engineering Section researches the area's hydrology and assembles the hydrological data. Part of this data includes the design discharges that are based on the following:

- duration and intensity of historical storms,
- grade of adjacent slopes,
- drainage area,
- width of pavement, and
- type and amount of ground cover.

Once there is an adequate amount of hydraulic data, the assigned hydraulic designer determines the proper design of the hydraulic structures, inlets, outlets, type of channel linings, and pipe sizes and types. The drainage system often includes:

- storm drainage systems,
- ditches,
- channels,
- energy dissipators,
- retention basins, and
- siltation basins.

The Hydraulic Engineering Section forwards the Hydraulic Report to the Road Design Group to incorporate any necessary drainage considerations into the Right of Way Plans ([Task 20](#)).

The Hydraulic Engineering Section will provide the Bridge Hydrology Report to the Bridge Design Section ([Task 12](#)).

PROJECT TASK

Task Title: Begin Utility Coordination Process

Task No.: 14

Responsible Unit: Utilities Office (Utilities)

Task Description:

Utility facilities impacted by the project are identified during the preliminary stages of project development and are shown in the Design Field Review Plans ([Task 10](#)). These plans are used by the Utilities Office to determine which utility companies are affected by the design and will require relocation or adjustments. The Utilities Office will furnish each affected company with a set of plans for their use in determining conflicts.

The type of utility relocation work required will depend on the location of the existing utility and the location to which the utility will relocate. The work involves moving utility facilities or lowering or raising the utility facilities to clear construction conflicts.

The types of public utility companies that may be involved in a project include:

- electric,
- telephone,
- water,
- sewer,
- gas, and/or
- cable TV.

For further guidance on utility coordination, see [Chapter 5](#).

PROJECT TASK

Task Title: Conduct Design Field Review

Task No.: 15

Responsible Unit: Road Design Group

Task Description:

Once the Design Field Review Plans are completed, the Road Design Group selects the personnel involved in the field review based on the type of project, funding and location. Participants who may assist in the field review include the Program Manager and representatives from:

- Traffic Engineering Division,
- Bridge Design Section,
- Preliminary Design Group,
- Environmental Management Office,
- Right of Way Office,
- Hydraulic Engineering Section,
- Utilities Office,
- District Office,
- Construction Division,
- FHWA, and/or
- Local officials (MPO/COG, City or County Engineer).

The Design Field Review Plans present the proposed preliminary design, document the field conditions and provide the basis for the Design Field Review. The Design Field Review is an evaluation of the preliminary design in terms of traffic patterns, drainage systems, right of way, utilities and topography. At this point in the project's development, the completeness of the plans is evaluated and any design features that need to be adjusted are identified (e.g. retaining walls, culverts).

The Road Design Group will incorporate revisions of the Design Field Review Plans during [Task 17](#). The Program Manager will complete the following other tasks associated with the Design Field Review Plans:

- complete and distribute copies of the final preliminary design to the Multidisciplinary Team;
- coordinate the review of cost estimate and resolve the differences, if necessary; and
- complete the Project Planning Report.

PROJECT TASK

Task Title: Begin Environmental Process

Task No.: 16

Responsible Unit: Environmental Management Office

Task Description:

The Program Manager initiates the environmental process by submitting the Project Planning Report to the Environmental Management Office.

There are three classes of anticipated environmental impacts — Class I – Environmental Impact Statement (EIS), Class II – Environmental Assessment (EA) and Class III – Categorical Exclusion (CE). The decision as to which level of action is required is based on how a project will impact the social, economic or environmental aspects of a region, the location of the proposed project, and how the proposed project will change the layout or function of connecting roads or streets. For further information on environmental procedures, see [Chapter 27](#).

During this Task the Environmental Management Office will generally conduct the following activities:

- evaluate the data in the Project Planning Report and determine any project impacts;
- determine the level of action required for the project;
- submit a copy of the Project Planning Report to the State Energy Office and FHWA, as appropriate;
- notify the Program Manager and appropriate SCDOT Sections of the level of action for the project;
- prepare the draft environmental document;
- submit the draft environmental document for approval;
- distribute the environmental document for review and comment;
- in coordination with the Program Manager, arrange and conduct a public hearing, if necessary. If visualization techniques are required, the Environmental Management Office will be involved in the preparation of these displays with the Engineering Visualization Group in the Road Design Section;
- revise the final environmental document, as necessary; and/or
- submit and obtain approval for the final environmental document.

PROJECT TASK

Task Title: Begin Right of Way Plans

Task No.: 17

Responsible Unit: Road Design Group

Task Description:

Based on the results of the Design Field Review and the Project Planning Report ([Task 15](#)), the Road Design Group will begin the preparation of the Right of Way Plans. The Design Field Review Plans are used to complete the Right of Way Plans so that other Units can complete their work. The Right of Way Plans should include the following sheets:

- Title Sheet,
- Typical Sections and Miscellaneous Details,
- Right of Way Data Sheets,
- Property Strip Map,
- Plan and Profile Sheets,
- Details of Plan Sheets, and
- Cross Sections.

[Chapters 33](#) and [34](#) provide additional guidance on the contents of these plans.

PROJECT TASK

Task Title: Perform Constructability Review

Task No.: 18

Responsible Unit: Constructability Review Team

Task Description:

A constructability review is a process that utilizes construction personnel with extensive construction knowledge early in the design stage to insure that a project is buildable, as well as cost effective, biddable and maintainable. The Program Manager will determine whether a project should include a constructability review. Most Interstate reconstruction, widening and interchange reconstruction projects along with non-Interstate projects where the estimated construction costs exceed \$25 million should include a constructability review. The Program Manager will provide the Constructability Review Team with a copy of the Design Field Review Plans and the Project Planning Report. During its review, the Constructability Review Team should insure:

- The project, as detailed in the plans and specifications, can be constructed using standard construction methods, materials and techniques.
- The plans and specifications provide the contractor with clear and concise information that can be used to prepare a competitive, cost-effective bid.
- The project, when constructed in accordance with the plans and specifications, will result in a project that can be maintained in a cost-effective manner by the Department over the life of the project.

For additional guidance on Constructability Reviews, see Engineering Directive Memorandum PC-11 and C-22.

PROJECT TASK

Task Title: Complete Environment Document

Task No.: 19

Responsible Unit: Environmental Management Office

Task Description:

Based on the comments received on the draft environmental documents and the public hearing ([Task 16](#)), the Environmental Management Office will prepare and submit the final environmental document for approval. The final environmental document will be forwarded to the Road Design Group to prepare the Final Construction Plans ([Task 26](#)). The environmental document needs to be completed before right of way acquisition can occur.

PROJECT TASK

Task Title: Finalize Right of Way Plans

Task No.: 20

Responsible Unit: Road Design Group

Task Description:

After receiving the following information, the Road Design Group will finalize the Right of Way Plans:

- recommendations from the public hearing and environmental studies ([Task 16](#));
- results from the Bridge Type, Structure and Layout Studies ([Task 12](#));
- hydraulic drainage design ([Task 13](#)); and
- comments and recommendations from the Constructability Review Team ([Task 18](#)).

Completion of the Right of Way Plans will allow the following activities to take place:

- the Right of Way Office will acquire the necessary properties and easements ([Task 22](#));
- the Utility Office will finalize agreements with the affected utility and railroad companies ([Tasks 23](#) and [24](#));
- the Environmental Management Office will secure the necessary permits ([Task 25](#));
- the Traffic Engineering Division will prepare the Electrical and Lighting Plans, Pavement Marking Plans, Signing Plans, Traffic Signal Plans and Sequence of Construction and Traffic Control Plans ([Task 27](#));
- the Bridge Design Section will prepare Bridge Plans ([Task 28](#)); and
- the Office of Beautification will prepare the Landscaping Plans.

PROJECT TASK

Task Title: Prepare Roadway Structures Plans

Task No.: 21

Responsible Unit: Roadway Structures Design Group

Task Description:

Based on the information provided in the Design Field Review Plans ([Task 10](#)) and the Project Planning Report ([Task 15](#)), the Roadway Structures Design Group will prepare the designs and plans for roadway and hydraulic structures other than those designed by the Hydraulic Engineering and Bridge Design Sections (e.g., embankments, retaining walls, noise barrier walls, culverts, modified drainage boxes).

The Roadway Structures Design Group may request a geotechnical investigation to determine the type of foundation necessary for the structure (e.g., bearing values, ground improvements, piles, footings). Using the selected foundations, the Roadway Structures Design Group performs a structural assessment of possible designs and drafts the structure plans.

After completing the Roadway Structures Plans, the Roadway Structures Design Group will forward the plans, specifications and quantities to the applicable Road Design Group for assembly into the Final Construction Plans ([Task 30](#)).

PROJECT TASK

Task Title: Acquire Right of Way

Task No.: 22

Responsible Unit: Right of Way Office

Task Description:

Before a project can be let to contract, the Department must have title to all property included in the project's right of way. Deeds or easements are often acquired from private individuals, municipalities, businesses, and State and Federal agencies.

The following steps occur in acquiring the property:

- initiate contact with land owner,
- preparation of an appraisal,
- offer for right of way,
- acceptance of offer by property owner,
- deed or easement is conveyed and payment is made, and
- acquisitions of property by *Eminent Domain Procedures Act*.

Where there are revisions and commitments due to negotiations with the property owners, the Right of Way Office will forward these items to the Road Design Group for incorporation into the Final Construction Plans ([Task 30](#)).

For additional guidance on right of way procedures, see [Chapter 30](#).

PROJECT TASK

Task Title: Implement Railroad Coordination Process

Task No.: 23

Responsible Unit: Utilities Office (Railroads)

Task Description:

Railroad facilities impacted by the project are identified during the preliminary stages of project development and shown in the Right of Way Plans ([Task 20](#)). These plans are used by the Utilities Office to determine which railroad companies are affected by the project and will require coordination. For any involvement other than grade separation, the Utilities Office will submit a letter and plans to each affected company. The type of work required will depend on the location of the proposed project and the location of the existing railroad.

After receiving the Right of Way Plans ([Task 20](#)), the Utilities Office coordinates with the railroad companies to prepare any necessary agreements for the proposed work.

The Utilities Office works with the railroad companies to resolve any discrepancies and revise the plans as necessary to secure appropriate approval.

The Utilities Office assists in the preparation of any Special Provisions that are to be included in the final contract. The Special Provisions list all the involved railroad companies, unusual construction methods, and any critical information or special considerations for the contractor. These are forwarded to the Road Design Group for incorporation into the Final Construction Plans ([Task 30](#)).

For further guidance on railroad coordination, see [Chapter 6](#).

PROJECT TASK

Task Title: Continue Utility Coordination Process

Task No.: 24

Responsible Unit: Utilities Office (Utilities)

Task Description:

After receiving the Right of Way Plans ([Task 20](#)), the Utilities Office continues to coordinate with the utility companies by requesting that the utility company review the Right of Way Plans and the information in the letter and prepare a tentative Utility Agreement and/or relocation sketches. The Utility Agreement (Form 3068A) should include the following:

- prior rights information,
- description of relocation work,
- a cost estimate,
- relocation sketches (showing existing and proposed facilities), and
- any Special Provisions that need to be addressed.

The Utilities Office reviews the Utility Agreement and/or relocation sketches and coordinates any necessary revisions. Once completed, the utility company executes the Agreement and forwards it to the Utilities Office through the Resident Construction Engineer and District Engineering Administrator for approval and execution. For projects with Interstate funds or Federal projects over \$50 million, Utility Agreements and/or relocation sketches are forwarded to FHWA for their approval.

If the utility work is to be completed by the SCDOT contractor, the Utilities Office will coordinate the preparation of the Utility Relocation Plans and any necessary special provisions. These are forwarded to the Road Design Group for incorporation into the Final Construction Plans ([Task 30](#)).

PROJECT TASK

Task Title: Secure Permits

Task No.: 25

Responsible Unit: Environmental Management Office

Task Description:

After receiving the Right of Way Plans ([Task 20](#)), the Environmental Management Office begins the process of acquiring the necessary environmental permits. Permits are required for all types of highway improvement projects. Permits are used as a means of controlling activities that impact an area of particular concern. These areas of interest for the Department include wetlands, coastal zones, navigable waterways and power generating facilities. Consideration is also given to the impact of proposed improvements on the water quality of streams, rivers and wetlands. The permit authorizes or confers the right on the permittee to perform the work required within the requirements established by the permit. Types of requirements include monitoring programs, special construction methods and reclamation standards.

The Environmental Management Office coordinates with the permit-issuing agency to insure that any problems can be resolved and that all conditions are satisfactory to the Department.

For more information on permits, see [Section 27.5](#)

PROJECT TASK

Task Title: Develop Final Construction Plans

Task No.: 26

Responsible Unit: Road Design Group

Task Description:

The purpose of the Final Construction Plans is to refine the Right of Way Plans so that final project approval can be obtained. Based on the Project Development Team's review of the Right of Way Plans ([Task 20](#)), latest traffic data ([Task 6](#)) and approved pavement design ([Task 11](#)), the Road Design Group will complete the roadway design and drafting of all construction plans sheets.

A field review may also be conducted to reassess the plans for changes occurring since the last field review.

The Road Design Group will review and prepare any design exceptions and forward them to the Program Manager for processing. See [Section 9.2.2](#) for procedures for processing Design Exceptions.

The designer will coordinate with the Specifications and Estimates Group to prepare required Special Provisions.

PROJECT TASK

Task Title: Prepare Traffic Engineering Plans

Task No.: 27

Responsible Unit: Traffic Engineering Division

Task Description:

After receiving the final Right of Way Plans ([Task 20](#)), the Traffic Engineering Division will prepare all the necessary traffic engineering plans, Special Provisions and cost estimates. Typical traffic plans include:

- Signing Plans;
- Pavement Marking Plans;
- Traffic Signals Plans, including train approach signals and gates;
- Highway Lighting Plans; and
- Work Zone Traffic Control Plans.

The temporary work zone traffic control plans will identify where traffic is to be located during various phases of construction that encroach on current roadway locations. This plan should be a combination of small-scale drawings identifying areas of construction and showing the location of traffic during the respective construction encroachments. The drawing should be accompanied by a brief description of construction task and concurrent traffic operations.

After completing the Traffic Plans, the Traffic Engineering Division will forward the plans, specifications, quantities and cost estimates to the applicable Road Design Group for assembly into the Final Construction Plans ([Task 30](#)).

For more detailed information on traffic engineering issues, see [Chapter 28](#).

PROJECT TASK

Task Title: Prepare Bridge Plans

Task No.: 28

Responsible Unit: Bridge Design Section

Task Description:

Once the bridge type, structure and layout studies ([Task 12](#)) have been completed and they have received the Right of Way Plans ([Task 20](#)), the Bridge Design Section can begin the Bridge Plans. The Bridge Plans provide a detailed description of the structural design and geometric layout of any bridge within the project. These plans are used to calculate the structural quantities and to prepare cost estimates.

PROJECT TASK

Task Title: Complete Right of Way Acquisition and Local Agreements

Task No.: 29

Responsible Unit: Right of Way Office

Task Description:

The Right of Way Office must complete the Right of Way Acquisition ([Task 22](#)) and have all Participation Agreements signed and approved before the plans can be processed for letting ([Task 32](#)).

In terms of right of way acquisition, the Right of Way Office must have certification formally acknowledging that the Department holds title or right of entry is available to all properties within the project's right of way and that all property has been vacated.

The Participation Agreements must be signed by the local government and accepted by the Department.

PROJECT TASK

Task Title: Assemble Construction Plans

Task No.: 30

Responsible Unit: Road Design Group

Task Description:

At this stage of the project development process, the Road Design Group should receive the following information from other SCDOT Sections in order to maintain the project schedule:

- completed Roadway Structures Plans, quantities, Special Provisions and cost estimates from the Roadway Structures Design Group ([Task 21](#));
- Right of Way Plan revisions and commitments from the Right of Way Office ([Task 22](#));
- acknowledgement from the Utilities Office that all Railroad Agreements have been approved ([Task 23](#));
- where necessary, completed Utility Relocation Plans, quantities, Special Provisions and cost estimates from the Utilities Office ([Task 24](#));
- acknowledgement from the Environmental Management Office that all permits have been approved ([Task 25](#));
- completed Traffic Engineering Plans, quantities, Special Provisions and cost estimates from the Traffic Engineering Division ([Task 27](#)); and
- completed Landscaping Plans, quantities, Special Provisions and cost estimates from the Office of Beautification.

The Road Design Group will review these materials and is responsible for identifying and incorporating any information directly into the Final Construction Plans, including all quantities and plan sheets prepared by others.

PROJECT TASK

Task Title: Conduct Final Plan Review/Corrections/Obtain Signatures

Task No.: 31

Responsible Unit: Program Development Office/Road Design Section

Task Description:

After the Road Design Group has assembled the Construction Plans, the following activities will occur:

1. Quantities. The Program Manager is responsible for insuring the applicable sections (e.g., Traffic, Bridge) have provided the Road Design Group with any additional quantities to be incorporated into the plans. The road designer is responsible for entering all quantities into the Department's software package; see [Section 36.2.2](#).
2. Initial Acceptance. The Road Design Group Coordinator will submit the plans to their Facilitator for review. Once the Facilitator is satisfied with the Final Construction Plans, the Coordinator will submit the Final Construction Plans, the Design Field Review Plans and comments and all quantity computations to the Design Services Group.
3. Plan Review. The Design Services Group will conduct a quality control review of the plans. The Design Services Group will check the plans for completeness as described in [Section 37.1](#). The plans will be returned to the designer for corrections or clarifications. Upon completion of reviewing the corrections, the Design Services Group will submit the plans to the Hydraulic Engineering Section for review and signature.
4. Hydraulic Review. The Hydraulic Engineering Section will review the construction plans to insure the designer has correctly incorporated the design information from the Hydraulic Report. Upon the completion of the Hydraulic Engineering Section's review, the Hydraulic Design Engineer will sign the plans and forward them to the Program Manager.
5. Program Management Review. The Program Manager will review and sign the plans. The Program Manager will then forward the Final Construction Plans to the appropriate Program Development Engineer for signing and sealing. The Program Development Engineer will forward the plans to the Operations Center in the Road Design Section. The plans are then available for the Road Design Engineer to sign, seal and return to the Operations Center.

See [Section 37.1](#) for variations of the process for "C" projects.

PROJECT TASK

Task Title: Process Plans for Letting

Task No.: 32

Responsible Unit: Operations Center and the Specifications and Estimates Group

Task Description:

The Operations Center and the Specifications and Estimates Group are responsible for preparing the Bid Proposal. The following summarizes the procedures for preparing the Bid Proposal. For additional guidance, see [Section 37.2](#).

The Operations Center will:

1. Insure that all applicable units have reviewed and signed the road plans and that all necessary submittals have been made to the FHWA.
2. Calculate the cost of plans, enter the cost information into the Department's software package and merge projects (e.g., bridge plans, landscaping) into contracts for the letting.
3. Forward the construction plans to the Specifications and Estimates Group.

The Specifications and Estimates Group will:

1. Prepare the Engineer's Estimate; see [Section 36.2](#).
2. Calculate the contract completion date.
3. Calculate the Disadvantaged Business Enterprise (DBE) goal for Federally funded projects.
4. Solicit on the job trainees (OJT) requirements from the Office of Compliance.
5. Prepare the proposal by:
 - a. Preparing and incorporating all necessary Special Provisions.
 - b. Insuring that all pay items are covered by the *Standard Specifications*, *Supplemental Specifications* or by the Special Provisions.
6. Submit to the Operations Center the "List of Items" from the proposal. The Operations Center will forward the "List of Items" and the plans to the Design Services Group to insure the quantities, pay item numbers and pay items on the plan's Summary of Estimated Quantities Sheet and the proposal agree.

After the proposal has been completed and all necessary signatures have been obtained, the Operations Center and Specifications and Estimates Group forward the Final Construction Plans and proposals to the Engineering Reproduction Services for printing. After the printing has been completed, the bid documents are then forwarded to the Engineering Publications Customer Service Center within the Construction Division in accordance with the published schedule.

PROJECT TASK

Task Title: Conduct Letting

Task No.: 33

Responsible Unit: Contracts Administration Office

Task Description:

In conducting the letting, the Contracts Administration Office is responsible for the following:

1. Advertising. The Contracts Administration Office will prepare and publish an ad for the highway letting. This ad is placed on the Department's website approximately 5 weeks prior to letting. Authorization to bid is issued to prequalified contractors who have work ratings that indicate their ability to complete the work. The Contracts Administration Office determines this prequalification list. For large and/or multi-phased projects, it may be determined necessary to conduct a pre-bid meeting. The Program Manager and/or the designer may be asked to attend this meeting.
2. Conducting Bid Opening. At the opening hour of 11:00 am, the Contracts Administration Office will receive the Contractor's electronic bid. After the specified time, no additional bids will be accepted. The amount of each bid, including alternatives and combinations, if any, are recorded and read publicly.
3. Reviewing the Bids. The Contracts Administration Office will incorporate the bid information into the Trns•port System and check the bid for accuracy to insure the Contractor has correctly submitted the bid. If the bids have been properly submitted, the Contracts Administration Office will forward the lowest bid to the Program Manager for review. The Program Manager will resolve any substantial differences between the Contractor's bid and the STIP amounts. The Contracts Administration Office will coordinate the award with FHWA on all oversight projects.
4. Awarding the Project. If the low bid is determined to be acceptable, the Contractor and Program Manager are notified of the approval. Once the contract has been approved and signed, the project responsibilities are then transferred to the Resident Construction Engineer. The Utilities Office will distribute Utility and/or Railroad Agreements to the appropriate company.

Once the contract has been accepted and signed, the Contractor can begin construction on the project. At this project stage, the designer may be requested to clarify the construction plans, offer guidance, review shop drawings, etc.

Table of Contents

<u>Section</u>	<u>Page</u>
4.1	SCDOT UNITS EXTERNAL TO PRECONSTRUCTION DIVISION.....4.1(1)
4.1.1	Traffic Engineering Division4.1(1)
4.1.2	Planning Division4.1(2)
4.1.3	Construction Division4.1(2)
4.1.4	District Offices4.1(2)
4.2	PRECONSTRUCTION DIVISION.....4.2(1)
4.2.1	Program Development Section.....4.2(1)
4.2.1.1	Program Manager4.2(1)
4.2.1.2	Preliminary Design Group4.2(1)
4.2.2	Bridge Design Section4.2(1)
4.2.3	Right of Way Office.....4.2(2)
4.2.3.1	Coordination.....4.2(2)
4.2.3.2	Right of Way Plans4.2(2)
4.2.4	Environmental Management Office4.2(3)
4.2.5	Hydraulic Engineering Section.....4.2(5)
4.2.6	Surveys Office4.2(6)
4.2.7	Utilities Office.....4.2(7)
4.2.8	Road Design Section.....4.2(7)
4.2.8.1	Roadway Structures Design Group.....4.2(7)
4.2.8.2	CADD Support4.2(7)
4.2.8.3	Plans, Specifications and Estimates Group4.2(8)
4.2.8.4	Engineering/Consultant Services Unit.....4.2(8)
4.3	EXTERNAL AGENCIES4.3(1)
4.3.1	Federal Agencies.....4.3(1)
4.3.1.1	Federal Highway Administration4.3(1)
4.3.1.2	United States Forest Service (USFS).....4.3(1)
4.3.1.3	United States Postal Service (USPS).....4.3(1)
4.3.1.4	Federal Aviation Administration (FAA)4.3(2)
4.3.1.5	National Park Service (NPS).....4.3(2)

Table of Contents

(Continued)

<u>Section</u>	<u>Page</u>
4.3.2 Local Governments	4.3(2)
4.3.2.1 Local Highway Agencies	4.3(2)
4.3.2.2 Local Planning Agencies	4.3(2)

Chapter Four

ROAD DESIGN COORDINATION

During the development of a road design project, the Road Design Group must coordinate with many units internal and external to the Road Design Section. [Chapter 1](#) describes the functional responsibilities of selected Units within SCDOT. [Chapter 3](#) presents a network that describes the project development sequence for the road design process. This Chapter discusses specific coordination responsibilities between the Road Design Group and other Units. Together, the three Chapters will provide an understanding of the necessary interaction among the various Units in project development.

4.1 SCDOT UNITS EXTERNAL TO PRECONSTRUCTION DIVISION

The following Sections discuss coordination between the Road Design Groups and selected SCDOT Units external to the Preconstruction Division.

4.1.1 Traffic Engineering Division

The Traffic Engineering Division provides a variety of traffic engineering services to other Departmental Units (e.g., traffic control devices, highway capacity analyses, traffic engineering studies). The following describes the Traffic Engineering Division's coordination with the Road Design Group.

The Traffic Engineering Division is responsible for providing the Road Design Group with the following items:

- Work Zone Traffic Control Plans,
- design review comments,
- Signing And Pavement Marking Plans,
- safety analyses information,
- ITS information,
- Traffic Signal Plans,
- traffic data, and
- capacity analysis.

The Traffic Engineering Division receives copies of the Program Action Request and Project Planning Report. In addition, they receive the Design Field Review Plans, Right of Way Plans and Final Construction Plans for review. Typically, the Traffic Engineering Division will be invited to all field reviews and will receive all project-related correspondence.

4.1.2 Planning Division

The Planning Division is responsible for the development and implementation of the processes, systems and planning programs necessary for informed programming decisions of the Department's transportation projects. The Road Design Group will coordinate with the Planning Division to determine adjacent projects that may be affected by the design.

4.1.3 Construction Division

The Construction Division, in coordination with the District Offices, is responsible for all construction activities on all State-administered projects. This includes construction specifications, construction inspections, construction staffing and approval of construction change orders. The following summarizes the coordination between the Road Design Groups and the Construction Division:

1. Reports. The District Engineering Administrator receives copies of the Program Action Request and Project Planning Report. In addition, they receive the Design Field Review Plans, Right of Way Plans and Final Construction Plans for review. The Construction Division will review the plans and provide recommendations for changes to the Road Design Group.
2. Constructibility Reviews. As determined by the Program Manager, selected projects may undergo a constructibility review to insure that a project is buildable, cost effective, biddable and maintainable. Representatives from both the Construction Division and the Road Design Group will attend these reviews.
3. Bid Proposal. After the Final Construction Plans have been completed, the Operations Center will transmit the entire bid proposal package to the Contract Administration Office within the Construction Division for letting. The package will include the following:
 - Final Construction Plans;
 - quantities;
 - engineer's estimate; and
 - any Special Provisions.

4.1.4 District Offices

The Department's seven District Offices provide field services within each geographic area. Their responsibilities include maintenance of the State Highway System, construction inspection services, contacts with county and city governments and traffic-related activities (e.g., encroachment permits). Specifically for preconstruction

activities, the following summarizes the coordination between the Road Design Groups and the District Offices:

1. Coordination. In general, for all projects, the Road Design Groups will maintain continual contact with the District Office. The District Office, for example, will be invited to all field reviews and will receive all project-related correspondence.
2. Public/Local Governments. Contact with the public and local governments made by the Road Design Groups should be coordinated with the applicable District Office.

4.2 PRECONSTRUCTION DIVISION

4.2.1 Program Development Section

4.2.1.1 Program Manager

The Program Manager within the Preconstruction Division serves as the project lead and is responsible for all administrative functions for the project throughout the project development process. The Road Design Group must coordinate all official project correspondence with the Program Manager. The Program Manager is responsible for coordinating any major design changes or deciding whether to request a design exception.

4.2.1.2 Preliminary Design Group

The Preliminary Design Group within the Preconstruction Division performs the initial evaluation and engineering studies for the project before it is transferred to the Road Design Group for detailed design. The Preliminary Design Group selects the design speed and lays out the alignment, intersections and interchanges within the project limits. The Road Design Group will, as necessary, discuss the road design with the Preliminary Design Group and coordinate with the Preliminary Design Group if any major revisions are proposed.

4.2.2 Bridge Design Section

The Bridge Design Section is responsible for the structural design of all bridges on State-maintained highways. The following describes the coordination between the Road Design Groups and the Bridge Design Section:

1. Roadway Geometrics. The Preliminary Design Group provides the Bridge Design Section with the preliminary horizontal and vertical alignments. The bridge designer determines a preliminary structure length and depth of superstructure, and the bridge designer provides approximate bridge end elevations. The Road Design Group modifies the alignment as necessary, based on the preliminary grade recommendations from the bridge designer. The Bridge Design Section reviews and comments on the proposed roadway geometrics. The Bridge Design Section also determines the bridge width.
2. Approach Roadway. The Road Design Group is responsible for all roadway approach work.
3. Roadside Safety Appurtenances. The Bridge Design Section will select the type and design of the bridge rail. The Road Design Group will determine the design of the approaching guardrail transition into the bridge rail.

4. Sidewalks. The Bridge Design Section and the Road Design Group will jointly determine sidewalk requirements on bridges.
5. Plan Preparation. The Bridge Design Section prepares all necessary structural design plan sheets and submits these to the Operations Center for final construction plan assembly.

4.2.3 Right of Way Office

4.2.3.1 Coordination

The Right of Way Office is responsible for all activities related to the right of way for the State Highway System. This includes appraisals, acquisitions, relocation and property management. The following summarizes the coordination between the Road Design Groups and the Right of Way Office:

1. Coordination. The Road Design Section provides the Right of Way Office with the needed design information to determine the right of way impacts.
2. Plan Preparation. The Road Design Group provides the Right of Way Office with the Right of Way Plans. The Right of Way Office requests modifications from the Road Design Group to the Right of Way Plans based on contacts and negotiations with landowners and the search of public records to determine ownership.
3. Acquisition. The Right of Way Office performs all right of way work and procures all properties needed for the project. The Right of Way Office notifies the Road Design Group of any design considerations resulting from negotiations with the property owners.

4.2.3.2 Right of Way Plans

The following procedures apply to coordination between the Road Design Groups and the Right of Way Office for sending and receiving prints for obtaining new right of way, right of way revisions, handling of moving items, demolition items, reset fence and verifying existing right of way:

1. Plans. After the Right of Way Plans have been checked and all necessary signatures obtained, the proper number of prints will be sent to the Right of Way Office by the Operations Center's Coordinator. "C" project plans and other completed project plans will then be stored in the Road Design Operation Center. Federal projects and projects that are not complete for construction at this time will be maintained by the Road Design Group until completion of the Final Construction Plans and will be available from the Road Design Group.

The Right of Way Office can obtain CADD files from the Road Design Section by informing the Group Leader of the needed files. The Road Design Group Leader will then provide the files to the Right of Way Office for its use. Files should then be sent back to Group Leaders as soon as practical. It will then be the Road Design Group Leaders' responsibility to keep records of all files sent to and received from the Right of Way Office.

2. Revisions. Any plan revisions made after the Right of Way Plans are submitted must be detailed by placing a revision note on the appropriate plan sheet. Include in the revision note any tract numbers affected by the changes. All plan revisions should be routed to the Right of Way Office in the normal manner so the Right of Way Agent has the correct information to provide to the affected landowners.
3. Moving and Demolition Items. Moving and demolition items will be obtained and submitted to the Road Design Group by the District Engineering Administrator in accordance with the Engineering Directive Memorandum PC-24/C-19 — Moving and Demolition Items. Moving items and demolition items sheets will be placed on the plans before they are sent to the Right of Way Office. A final moving and demolition item list will be electronically submitted to the Road Design Group by the Right of Way Office based on the acquisition and negotiations with landowners. The list will include the total fencing to be reset during construction and should be shown on the General Construction Note "for resetting existing fence" and as a bid item on the "Summary of Estimated Quantities" sheets.
4. Existing Right of Way. The Road Design Group, using old plans, verifies the existing right of way. If the old plans contain recorded deeded information, then it is accepted as being verified and initialed by the Road Design Group person verifying the present right of way. If present right of way is shown on the plans, but does not have recorded right of way data, then the plans will be transferred to the Right of Way Office for verification. Dedicated right of way must be verified by deed or plat book and page number. The Survey Office or the Right of Way Office supplies this information to the Road Design Group.

4.2.4 Environmental Management Office

The Environmental Management Office is responsible for a variety of activities related to environmental impacts and procedures. This includes air, noise and water quality analyses; biological, archeological and historical impacts; preparation of environmental documents for SCDOT projects; evaluation and mitigation of hazardous waste sites; and public involvement. The following summarizes the coordination between the Road Design Group and the Environmental Management Office:

1. Permits/Approvals. The Road Design Group provides the Environmental Management Office with the project information needed for securing several

environmental permits/approvals (when required). The following provides examples of some of the required permits and approvals:

- U.S. Army Corps of Engineers Section 404/Section 10 permit(s); and
- U.S. Fish and Wildlife, U.S. Forest Service and Bureau of Land Management approvals.

The Environmental Management Office coordinates with the applicable Federal and/or State agencies, processes permit information, and seeks agency approvals. The Environmental Management Office notifies the Road Design Group when the permit or approval is received.

2. NEPA Requirements. The Road Design Group works with the Environmental Management Office to insure that the project meets the Department's environmental and public input criteria pursuant to the *National Environmental Policy Act* of 1969. This includes project documentation (i.e., categorical exclusion, EA, EIS), water quality impacts, biological impacts, historical impacts, archeological impacts and the need for public hearings. In general, the Environmental Management Office makes its determination of impacts based on input from the Road Design Group.
3. Section 4(f). A Section 4(f) approval is required if a project will impact publicly owned land (e.g., public park, recreational area, wildlife/waterfowl refuge and historical/archeological sites). An approval will be granted only if there is no feasible and prudent alternative. Where a Section 4(f) approval is required, the Road Design Group will provide the necessary project information to the Environmental Management Office, which will secure approval.
4. Section 6(f). Federal law places restrictions on the use of land acquired with funds authorized by the *Land and Water Conservation Act* of 1965 as administered by the U.S. Department of Interior (Section 6(f) of the LWCF). Where a Section 6(f) approval is required, the Road Design Group will provide the necessary project information to the Environmental Management Office, which will secure the approval.
5. Mitigation Features. The Environmental Management Office and Road Design Group work together on the plan for mitigation of environmental impacts.
6. Section 106. For all Federally funded projects, SCDOT must identify archeological and historic sites in the vicinity of the project. The identified sites must be evaluated to determine if they are eligible for the National Register of Historic Places (NRHP). SCDOT submits recommendations for eligibility to the State Historic Preservation Officer (SHPO) for its concurrence. If a site is considered eligible for the NRHP and if the project will impact the site, the Department is mandated to mitigate the adverse effects. The Environmental

Management Office and Road Design Group coordinate on satisfying the Section 106 procedures.

7. Wetland Mitigation. For wetland mitigation sites, the Environmental Management Office will determine the location, size and type wetlands of the site; review the hydrology with the Hydraulic Engineering Section to insure an adequate water supply; and provide a conceptual plan of the site. The Road Design Group is responsible for the preparation of plans, cross sections and summaries of quantities and for providing any Special Provisions that apply to construction items.

4.2.5 Hydraulic Engineering Section

The Hydraulic Engineering Section is responsible for performing and/or reviewing hydrologic and hydraulic analyses on all Federal-aid projects for both roadway drainage appurtenances and bridge waterway openings. The Road Design Group will calculate all quantities pertaining to drainage appurtenances and bridge waterway openings. The responsibilities of the Road Design Group and Hydraulic Engineering Section are as follows:

1. Culverts. For all box culverts and all pipe culverts with diameters greater than 24 inches, the Hydraulic Engineering Section will perform all work on the culvert design. This includes the:
 - hydrologic analysis to calculate the design flow rate based on the drainage basin characteristics;
 - hydraulic analysis to select the culvert dimensions and layout (e.g., longitudinal slope, invert elevations);
 - selection of culvert material (e.g., reinforced concrete, corrugated metal);
 - erosion control revetment; and
 - end treatments (e.g., energy dissipators).

The Road Design Section's Roadway Structures Design Group is responsible for the structural/service-life designs of culverts.

On projects where the Hydraulic Engineering Section does not perform the analyses, existing 24-inch pipes and smaller may be judged to be adequate during the design field review based on input from District personnel that the pipes have performed adequately.

2. Storm Drainage. The Road Design Group will present the proposed roadway design to the Hydraulic Engineering Section. See [Section 29.2.1.2](#) for the detailed information required from the Road Design Group prior to the Hydraulic Engineering Section beginning its storm drainage design.

3. Roadside Ditches. The Road Design Group determines the dimensions of the roadside ditch based on the criteria presented in [Chapters 13](#) and [19 through 23](#). Typically, no analysis is performed to determine hydraulic capacity. However, where determined necessary, the Hydraulic Engineering Section will evaluate the ditch and the potential for erosion and, if needed, recommend a permanent protective ditch lining.
4. Curb Ramps. To meet the requirements of the *Americans with Disabilities Act*, a project may require the installation of curb ramps that may, in turn, interfere with an existing curb inlet. In this case, the Road Design Group and the Hydraulic Engineering Section will work together to resolve the conflict.

4.2.6 Surveys Office

The Surveys Office is responsible for conducting aerial and field surveys for all Department projects. The following summarizes the coordination with the Road Design Group:

1. Field Survey. The decision that a field survey be required is made at the project concept stage. A survey request, outlining what is needed, is then submitted to the Preconstruction Surveys Office and assigned to the appropriate Regional Survey Group. Upon completion of the survey, the planimetric data of the site is plotted into a 2D MicroStation design file along with all alignment and property information. All cross section data is mapped into a 3D MicroStation Design file in the form of a digital terrain model or provided in ASCII files that are compatible for processing with the Department's design software. All files associated with the project are then placed on the network and the appropriate personnel notified that the survey information is available.
2. Aerial Surveys. The decision that an aerial survey is required is made at the project concept stage. A survey request is submitted to the Preconstruction Surveys Office that includes a proposed alignment outlined on a 7.5-inch USGS quad map. That information is then forwarded to an on-call aerial consultant with a request that a Contract Modification for the project be submitted. The Surveys Office, in most cases, will provide all ground surveys needed for an aerial project including the setting of panel points, traverses, drainage surveys and any additional data that might be required. The aerial consultant will provide all planimetric mapping in a 2D MicroStation design file and all Digital Terrain Models mapped in a 3D MicroStation design file as breaklines and spot elevations. All files associated with the project are then placed on the network and the appropriate personnel notified that the survey information is available.
3. Control Traverse. The Surveys Office insures that all horizontal and vertical control is set for the project and provides that information to the Road Design Section. The Road Design Section is responsible for that information being

placed on the plans in a form that can be easily found and understood by those charged with the task of constructing the project.

4.2.7 Utilities Office

The Utilities Office is responsible for coordinating with utility and railroad companies impacted by highway improvement projects. The following describes the coordination between the Utilities Office and the Road Design Groups:

1. Utility Coordination. After the Right of Way Plans are complete, the Road Design Group will provide the Utilities Office with a set of plans with the existing utilities plotted as determined from the survey. The Road Design Group will list the utility conflicts by station and offset from the centerline and place the subsurface utility locations on the cross sections. The Utilities Office will work with any impacted utility companies to implement the utility coordination process.
2. Railroad Coordination. The Utilities Office will work with the Road Design Group and other Department Units to prepare plans that incorporate railroad requirements and criteria and are acceptable to all parties.

4.2.8 Road Design Section

The Road Design Groups must coordinate the development of the Road Design Plans with the various Units within the Road Design Section. The following describes this coordination.

4.2.8.1 Roadway Structures Design Group

The Roadway Structures Design Group will prepare the design for small structures (e.g., retaining walls, box culverts and noise barrier walls). The Road Design Group will insure that these designs are compatible with the overall project design. The Roadway Structures Design Group will prepare the necessary contract plans and quantities for direct insertion into the overall set of construction plans and quantity estimates.

4.2.8.2 CADD Support

The Road Design Group is responsible for using the Department's computer-aided drafting and design packages (e.g., MicroStation, GEOPAK) in project development. CADD Support is available to assist the Road Design Group in their use.

4.2.8.3 Plans, Specifications and Estimates Group

The following describes the coordination between the Road Design Groups and Plans, Specifications and Estimates Group:

1. Bid-Proposal Documents. Once the Road Design Group has completed the final construction plans, quantities, Special Provisions and specifications, the Plans, Specifications and Estimates Group will transfer these to the Letting Preparation Group for assembly within the bid-proposal documents.
2. Reproduction. When the Road Design Group requires major printing efforts (e.g., Design Field Review Plans), the Road Design Group will coordinate with the Engineering Reproduction Services for the printing.
3. Plans Storage. The Plans Storage Unit is responsible for cataloging and storing the Final Construction Plans after they have been forwarded to the Contract Administration Office for letting. When needed, the Road Design Group will contact the Plan Storage Unit to retrieve the Final Construction Plans. The Final Plans Section stores the As-Built Plans.

4.2.8.4 Engineering/Consultant Services Unit

The following describes the coordination between the Road Design Groups and Engineering/Consultant Services Unit:

1. SCDOT Standard Drawings. Engineering Support maintains the *SCDOT Standard Drawings*. The Road Design Group will coordinate with Engineering Support to pose questions or to recommend revisions.
2. Visual Displays. When needed for public presentations, the Road Design Group will contact Engineering Visualization to prepare the maps, displays, etc.
3. Quality Control Review. The Design Services Group is responsible for conducting a quality control review of the Final Construction Plans prepared by the Road Design Groups.

4.3 EXTERNAL AGENCIES

In general, the Program Manager is responsible for coordinating with all agencies external to SCDOT. However, the Road Design Group may find it necessary to contact these agencies. This Section discusses the typical coordination activities between the Road Design Group and selected major units external to SCDOT.

4.3.1 Federal Agencies

4.3.1.1 Federal Highway Administration

The Federal Highway Administration (FHWA) administers the Federal-aid program, which funds eligible highway improvements nationwide. Their basic responsibility is to insure that the State DOTs comply with all applicable Federal laws in their expenditure of Federal funds and to insure that the State DOTs meet the applicable engineering requirements for their proposed highway projects. FHWA maintains a Division Office within each State, and this is the primary point of contact for a State DOT. All communications with FHWA must be coordinated through the Federal-aid Unit within the Preconstruction Management Section. [Section 9.9](#) describes FHWA's involvement in project development.

4.3.1.2 United States Forest Service (USFS)

USFS is responsible for the management of all national forests. USFS and the SCDOT currently have a Memorandum of Understanding (MOU) and approved procedures that describe the coordination between the two agencies for the planning and the development of projects having USFS involvement. If a proposed road design project will impact a national forest, the Road Design Group must coordinate the project development with USFS. USFS will, for example, be invited to any field reviews and receive copies of major project reports (e.g., Project Planning Report). In some cases, project actions will require USFS approval (e.g., right of way acquisition).

4.3.1.3 United States Postal Service (USPS)

Coordination with USPS may be necessary to determine location of mail delivery points and mailbox turnouts and to insure that crash-tested mailboxes are installed on the project.

4.3.1.4 Federal Aviation Administration (FAA)

Coordination may be necessary with FAA when road projects are located in the vicinity of airports. The anticipated development of the airport and existing traffic patterns that involve the airport should be considered during the design process.

4.3.1.5 National Park Service (NPS)

Coordination with NPS will be necessary where road projects are in the vicinity of land under the jurisdiction of NPS. Although the Department has no formal agreement with NPS, the level of involvement on projects will be similar to that between SCDOT and USFS.

4.3.2 Local Governments

4.3.2.1 Local Highway Agencies

The following describes the coordination between the Road Design Groups and local highway agencies:

1. Design. The Program Manager is responsible for soliciting input from the local government on road design projects in that locality and, in general, keeps the local governments up-to-date on any current or planned activities. For example, the decision on whether to provide open or closed drainage on an urban street is heavily influenced by input from the locality. In addition, larger municipalities may have their own design criteria, which must be considered during the design process. The Program Manager will keep the Road Design Group apprised of all local requirements.
2. Coordination. The Road Design Group, in coordination with the Program Manager, typically invites the local government to any field reviews and provides the local government with copies of major project reports.
3. Assistance. The Road Design Group provides technical assistance to the city and county governments, upon request. The Road Design Group responds to any verbal or written inquiries from local governments on road design issues.

4.3.2.2 Local Planning Agencies

All local governments conduct planning activities (e.g., land use, zoning). For road design projects, the Department must coordinate with the local planning agencies, Metropolitan Planning Organizations (MPO) and Council of Governments (COG) to insure that the projects are consistent with local planning activities.

Table of Contents

<u>Section</u>	<u>Page</u>
5.1 BACKGROUND	5.1(1)
5.2 SURVEYS/SUBSURFACE UTILITY ENGINEERING	5.2(1)
5.3 DESIGN AND COORDINATION	5.3(1)
5.3.1 Schedule For Relocation	5.3(1)
5.3.2 Encroachment Permits	5.3(1)
5.3.3 Required Forms.....	5.3(2)
5.4 REFERENCES.....	5.4(1)

Chapter Five

UTILITY COORDINATION

5.1 BACKGROUND

Utilities that are encountered on highway projects may include but are not limited to power, phone, cable, gas, water and sewer and may be located aboveground or underground. By State statute, public utilities are allowed to encroach on the highway right of way through the encroachment permit process.

This Chapter focuses on the necessary coordination, information, scheduling and design considerations related to the location, relocation and maintenance of utilities affected by a highway project. Utility related activities with highway design involve designing to avoid or minimize utility impacts; determining utility conflicts; and notifying and coordinating with the appropriate companies.

All utility relocations must be in accordance with the Department's *A Policy for Accommodating Utilities on Highway Rights of Way* and the *Code of Federal Regulations*, Title 23, Chapter 1, Subchapter G, part 645, subparts A and B. The Department has developed the *Policy* to regulate utility work including the location, manner, installation and adjustment of utility facilities. This type of work must be accomplished safely to insure that the utilization and future development of the highway is not impaired. Designers and the Utility Companies should follow the guidelines presented in the *Policy*.

5.2 SURVEYS/SUBSURFACE UTILITY ENGINEERING

The standard survey practice of accurately finding the location and elevation of all aboveground utility topography will continue for most projects. For other projects, where the location of underground utilities is considered critical to the design process, use the Subsurface Utility Engineering (SUE) services.

SUE is a method for identifying the location of subsurface utilities at various levels of quality. Each quality level is defined by the thoroughness, accuracy and methods used in gathering the subsurface utility information.

A representative of the Utilities Office working with the SUE firm, as well as the Project Development Team, will determine the extent of utility delineation and the appropriate levels needed based on the utility information available, utility risks and project budgetary constraints. Once the Department has contracted with the SUE firm for the required quality level(s), the SUE firm will be responsible for obtaining some or all of the following utility information in accordance with the current Department SUE CADD criteria and will be responsible for the negligent errors or omissions in the data. The following is the minimum data required:

- utility ownership information for all utilities within the project limits,
- location of all underground utilities,
- location of all aboveground utility topography,
- location of all utility poles including identification number,
- location of all aerial utility facilities, and
- utility details as required by the standard Utility Data Sheets.

5.3 DESIGN AND COORDINATION

The Road Design Group should make every effort to design a project that will avoid conflicts with major utilities. The Typical Sections, horizontal and vertical alignments, and the location of storm drainage lines can sometimes be adjusted while maintaining appropriate safety and design criteria. The increased cost of some utility avoidance provisions may be offset by reduced utility relocation costs, reduced construction time and result in an overall cost savings to the project.

If utility conflicts cannot be avoided, early coordination between the designer and the Utilities Office is important to facilitate the collection of all data necessary for plan preparation, submittal of the relocation sketches and development of any required Utility Agreements. The Utility Company is responsible for the design of the utility relocation, which must be approved by the Department. Therefore, it is important that coordination occur early and often to avoid delays during project construction. The Design Field Review provides an early opportunity for checking and identifying utilities that may be impacted by a highway project.

It is the responsibility of the road designer to insure that the required utility information is plotted on the plans. Copies of the plans, at various stages of development, are to be furnished to the Utilities Office in order to provide this information to the affected Utility Companies.

Utility Companies will review the information shown on the plans and make any corrections, additions and adjustments required. When a Utility Company has prior rights, a Utility Agreement will be prepared. All relocations, regardless of prior rights, will require utility relocation sketches.

5.3.1 Schedule For Relocation

It is important that the utility coordination procedures be performed early and often during project development. When practical, the relocation of utilities should be completed prior to the start of construction of the highway project. When performed during construction, utility relocations should be accomplished at the earliest practical date and in a manner that causes the least interference with construction progress. Follow-up procedures are vitally important to insure that the work of relocating the utilities will not unduly interfere with and delay the construction project.

5.3.2 Encroachment Permits

A permit must be issued before any new utility is installed or work is performed on the highway right of way. Permits are also required where a Utility Company desires to attach service lines to a bridge structure. For further guidance, review the procedures

described in the Department's *A Policy for Accommodating Utilities on Highway Rights of Way*.

5.3.3 Required Forms

The permits and forms associated with location and relocation of utilities during the preconstruction process are as follows:

- Form 3068A — Utility Agreement,
- Form 637 — Permit Application for Construction and Maintenance of Public Service Utility Line Along a State Highway,
- Form 638 — Application for Encroachment Permit Other than a Public Utility, and
- Form 739 — Performance Bond.

5.4 REFERENCES

1. *A Policy for Accommodating Utilities on Highway Rights of Way*, South Carolina Department of Transportation, current edition.
2. *Code of Federal Regulations*, Title 23, Chapter 1, Subchapter G, Part 645, subparts A and B.
3. *Federal-Aid Policy Guide*, Federal Highway Administration.
4. *A Policy on the Accommodation of Utilities on Freeway Right of Way*, AASHTO, 1989.

Table of Contents

<u>Section</u>	<u>Page</u>
6.1 GENERAL	6.1(1)
6.2 DESIGN ISSUES.....	6.2(1)
6.2.1 Types Of Roadway/Railroad Interfaces	6.2(1)
6.2.1.1 At-Grade Crossings	6.2(1)
6.2.1.2 Roadway/Railroad Grade Separations	6.2(1)
6.2.1.3 Parallel/Close Proximity Location Restrictions	6.2(2)
6.2.2 Drainage Design.....	6.2(2)
6.2.3 Sidewalks	6.2(3)
6.2.4 Right of Way Verification	6.2(3)
6.3 PLAN DEVELOPMENT	6.3(1)
6.3.1 All Projects.....	6.3(1)
6.3.2 Grade-Separated Crossings	6.3(1)
6.3.3 Rail Relocations.....	6.3(2)
6.3.4 Plan Distribution	6.3(2)
6.4 REFERENCES	6.4(1)

Chapter Six

RAILROAD COORDINATION

6.1 GENERAL

All roadway work affecting a railroad will require the Utilities Office to acquire the approval of and process an agreement with the Railroad Company. Because the processing of agreements with Railroad Companies may take significant time to obtain, early coordination with the Utilities Office is necessary to minimize potential delays to the project.

Roadway and structural designers need to recognize the design requirements of the Railroad Companies and provide the necessary design controls to accommodate the operational requirements of both the roadway and the railroad. All railroad at-grade crossing installations and any other work related to railroad facilities are performed by the Railroad Company except for grade separation structures which are designed and constructed by SCDOT.

This Chapter provides information for roadway projects where a railroad is a design consideration whether it involves a crossing of the railroad by the roadway, a parallel encroachment or obtaining right of way belonging to a Railroad Company. Work involving a railroad will be identified in an agreement between SCDOT and the Railroad Company. Processing of this agreement is the responsibility of the Utilities Office.

6.2 DESIGN ISSUES

6.2.1 Types Of Roadway/Railroad Interfaces

Roadways can conflict with existing railroads by crossing them or by being in close proximity to them. The conflict of roadways with rail lines is a safety and operational concern. The following railroad and roadway interfaces should be considered during design:

- at-grade crossings,
- grade-separated crossings, and/or
- parallel or close proximity locations.

6.2.1.1 At-Grade Crossings

Warning devices will be required for at-grade crossings that are within the limits of Federal-aid roadway projects and at locations where traffic engineering studies deem these devices necessary. Warning devices are designed and installed by the Railroad Company; however, the road designer must consider the restrictions of the railroad signals. The following should be considered for at-grade crossings to insure that the railroad gates are able to completely block traffic from crossing the tracks:

- maximum gate lengths,
- median type,
- median width, and
- minimum offset of railroad device from the edge of pavement.

The designer should consult with the Utilities Office for the latest warning device specifications when an at-grade crossing is being designed.

Criteria for the design, placement and installation of signs and pavement markings for railroad and roadway at-grade crossings are covered in the *Manual on Uniform Traffic Control Devices* (MUTCD).

The geometric design of railroad and roadway at-grade crossings should adhere to design criteria in [Section 15.8](#).

6.2.1.2 Roadway/Railroad Grade Separations

For grade-separated crossings, the geometrics of the roadway and structure that provides an overpass or underpass of a railroad are very similar to those for a highway grade separation without ramps, but must meet special horizontal and vertical clearances required for the safe operation of the railroad.

The roadway approach grades, roadway cross section, bridge grade and bridge width must be closely coordinated. Relevant design criteria for both are discussed in [Chapters 9 through 22](#) of this *Manual*.

The Bridge Design Section is responsible for insuring the structure design meets vertical and horizontal clearances and other criteria required by the Railroad Company. On a Federal-aid oversight project, the Federal Highway Administration must also approve these plans. Following approval of the Preliminary Bridge Plans by the Railroad Company, the Utilities Office will process the necessary agreements for the project with the Railroad Company.

The vertical clearances must be a minimum of 23 feet – 0 inches from the top of rail to the bottom of the superstructure. Additional vertical clearance may be provided where it is cost effective to do so. Existing clearance should be maintained for widening projects.

6.2.1.3 Parallel/Close Proximity Location Restrictions

A roadway parallel to and in close proximity to a railroad requires special attention by roadway designers. Although the project may not result in a direct conflict between the railroad and roadway, the proximity of the two can affect drainage design, traffic signals, etc. Make every effort to avoid encroachment on or disturbance to the railroad. [Section 15.8](#) discusses railroad crossings near intersections.

6.2.2 Drainage Design

The drainage design for road projects involving a railroad should include the following design considerations:

- Place pipe, catch basins, manholes or other structures a minimum of 20 feet from centerline of nearest track.
- Pipe placed parallel to track should have a minimum diameter of 24 inches.
- Pipe placed under the track should have a minimum diameter of 24 inches, (36 inches for Norfolk Southern tracks), and should be smooth steel meeting AREA guidelines. Pipe must be placed by the trenchless (jack and bore) method unless otherwise approved by the Railroad Company.
- Minimum cover over pipe should be 4.5 feet from the top of pipe to the base of rail unless otherwise approved by the Railroad Company.
- Show direction of flow on the Plan Sheets for drainage patterns.

- Show re-laid sideline pipes in their existing position and at the correct location to drain the newly constructed roadway ditches.

6.2.3 Sidewalks

Any concrete curb, gutter or sidewalk must terminate a minimum of 12 feet from the centerline of the track. Where sidewalk crosses the track, use asphalt across the track area.

6.2.4 Right of Way Verification

It is very difficult to verify railroad right of way widths for Right of Way and Construction Plans. Railroad right of way records are not readily available to SCDOT.

Where any railroads are encountered and railroad right of way is present, show the railroad right of way on the plans from the information that is received in the location survey. This information may be obtained from property plats, old plans and/or tax maps.

Once the Right of Way Plans are sent to the Right of Way Office, the plans should be sent to the Railroad Company via the Utilities Office. The Railroad Company should review the plans and advise the Department of any discrepancies in the railroad right of way.

6.3 PLAN DEVELOPMENT

The information required for design drawings depends on the type of roadway/railroad interface. Some information is required in the plans while other drawings are generated specifically for use by the Railroad Companies. For more information on how to incorporate railroad related information into the plans and on how to generate sheets for the Railroad Companies, see [Section 34.2.17](#) and the Road Design *Plan Preparation Guide*.

6.3.1 All Projects

Include the following information on the plans for all projects with roadway and railroad interfaces:

- right of way;
- owner of all tracks;
- distance to nearest railroad mile post;
- US DOT crossing number where an at-grade crossing is within the project limits;
- details of present and proposed roadway cross sections;
- finished roadway grade to match top of the rails (in some instances, the rails may be adjusted if approved by the Railroad Company); and
- actual location of curb, median or sidewalk from tracks (minimum of 12 feet from centerline of nearest track is required).

6.3.2 Grade-Separated Crossings

For grade-separated crossings, the Railroad Company requires:

- a profile on the survey centerline beneath the bridge;
- a traverse on the centerline of the railroad for a minimum of 200 feet left and 200 feet right of the roadway survey centerline with the appropriate topography; and
- cross sections perpendicular to the track.

No profile for the railroad traverse is necessary. Also, include the roadway fill slopes on the three interior cross sections that are perpendicular to the track. If these cross sections are omitted from the survey, contact the appropriate Engineer as soon as possible.

This information is for the Railroad Company's use only. Do not include these sheets in the Final Construction Plans. These sheets should be given to the Bridge Design Section for submission to the appropriate Railroad Company for their preliminary review along with the Bridge Plans.

For the Roadway Plans, cross sections are required every 25 feet within the railroad right of way. Show the cross sections for 100 feet on each side of survey centerline. Beyond 100 feet of centerline, provide elevations for the top of rails.

6.3.3 Rail Relocations

On projects that may require rail relocations, the designer should contact the Utilities Office as early as possible to determine feasibility and applicable railroad requirements.

6.3.4 Plan Distribution

The road designer should thoroughly review the Design Field Review Plans to determine if there is any railroad involvement and note any involvement on the Title Sheet.

Where there is railroad involvement, plans are sent to the Utilities Office. Road Design Groups must provide any revised plans to the Operations Center for distribution to the Utilities Office for any subsequent change to plans affecting the railroad right of way.

6.4 REFERENCES

1. *Road Design Plan Preparation Guide*, South Carolina Department of Transportation, 2000.
2. *Federal Aid Policy Guide*, December 1991, Transmittal 1, 23 CFR 646B.

Table of Contents

<u>Section</u>	<u>Page</u>
7.1 FEDERAL-AID FUNDING	7.1(1)
7.1.1 National Highway System	7.1(1)
7.1.2 Interstate System/Maintenance Program	7.1(2)
7.1.3 Surface Transportation Program	7.1(2)
7.1.3.1 General	7.1(2)
7.1.3.2 Urban	7.1(3)
7.1.3.3 Rural	7.1(4)
7.1.3.4 Bridges	7.1(4)
7.1.3.5 Safety	7.1(4)
7.1.3.6 Transportation Enhancements	7.1(5)
7.1.4 Bridges	7.1(5)
7.1.4.1 General	7.1(5)
7.1.4.2 Highway Bridge Replacement and Rehabilitation Program	7.1(5)
7.1.4.3 Major Bridge Program	7.1(6)
7.1.4.4 Discretionary Bridge Program	7.1(6)
7.1.4.5 Innovative Bridge Research and Construction Program ..	7.1(6)
7.1.4.6 National Historic Covered Bridge Preservation Program ..	7.1(6)
7.1.5 Federal Lands Highways	7.1(7)
7.1.6 Emergency Relief	7.1(7)
7.1.7 Congestion Mitigation and Air Quality Improvement	7.1(7)
7.1.8 National Scenic Byways Programs	7.1(8)
7.2 STATE FUNDING	7.2(1)
7.2.1 Federal-Aid Matching Funds	7.2(1)
7.2.2 State Programs	7.2(1)
7.2.3 "C" Fund Program	7.2(1)
7.3 JURISDICTIONAL SYSTEMS	7.3(1)
7.3.1 State Highway System	7.3(1)
7.3.2 County Road System	7.3(1)
7.3.3 Municipal System	7.3(1)
7.3.4 Federal Lands	7.3(1)
7.3.5 National Network (for Trucks)	7.3(1)

Chapter Seven

HIGHWAY FUNDING/SYSTEMS

South Carolina receives funding for its capital improvement program from a variety of sources. This Chapter provides an overview of the major sources that provide funding for projects on highway facilities. It also briefly discusses the segregation of the highway system into jurisdictional entities, including the National Network.

7.1 FEDERAL-AID FUNDING

Through fuel and excise taxes, the United States government collects revenues for constructing and improving the Federal and State Highway Systems. This money is collected into the Highway Trust Fund (HTF). The U.S. Congress appropriates this money back to the State governments through Transportation Acts, typically every six years. The Federal Highway Administration is responsible for distributing these funds to the States based on the guidelines provided in these Transportation Acts.

Funding has been expanded to encompass not only highway projects but also transit and environmental projects. All States receive Federal-aid funding, but the amount is dependent, among other factors, on the revenue contribution of each individual State. Federal-aid distribution includes a Minimum Guarantee provision to insure that each State receives a guaranteed minimum funding based on a State's contribution to the HTF.

The functional classification of a road or street facility is one of the significant factors that affect Federal-aid funding eligibility for several categories. [Section 9.4.1](#) discusses the functional classification system. Note that "local" facilities (i.e., those off the State Highway System) may be functionally classified as local, collector or arterial.

This Section discusses the different funding categories.

7.1.1 National Highway System

The National Highway System (NHS) is a network of principal arterial routes identified as essential for international, interstate and regional commerce and travel; national defense; and the transfer of people and goods to and from major intermodal facilities. The NHS represents approximately 4 to 5 percent of the total public road mileage in the United States. Specifically, the NHS includes the following subsystems (note that in a few cases a specific highway route may be on more than one subsystem):

1. Interstate. The current Interstate system of highways retains its separate identity within the NHS. There are also provisions to add mileage to the existing Interstate subsystem.
2. (Selected) Other Principal Arterials (OPA). These are selected highways in rural and urban areas that provide access between an arterial and a major port, airport, public transportation facility or other intermodal transportation facility.
3. Strategic Highway Network (STRAHNET). This is a network of highways that are important to the United States' strategic defense policy and which provide defense access, continuity and emergency capabilities for defense purposes. All Interstates are part of STRAHNET.
4. Major Strategic Highway Network (STRAHNET) Connectors. These are roads and highways that provide access between major military installations and highways that are part of the Strategic Highway Network.
5. Major Intermodal Connectors. These are selected streets and highways (primarily in urban areas) that provide access between another NHS designated route (Interstate or OPA) and a designated major port, airport, public transportation facility, freight facility or other intermodal transportation facility.

To properly manage the NHS, ISTEA initially mandated that each State highway agency develop and implement several management systems and one monitoring system for those facilities on the NHS. These include management systems for pavements, bridges, traffic congestion, safety, public transportation facilities/equipment, traffic monitoring and intermodal transportation facilities/systems. However, the *NHS Act* of 1995 eliminated the requirements for these management systems.

7.1.2 Interstate System/Maintenance Program

The National System of Interstate and Defense Highways retains a separate identity within the NHS. To insure the continued maintenance and improvement of this system, the IM program was established under ISTEA. These funds are distributed based on each State's lane-miles of Interstate routes open to traffic, vehicle-miles traveled on those Interstate routes, and contributions to the Highway Trust Fund attributable to commercial vehicles. Interstate reconstruction is also eligible for IM funds.

7.1.3 Surface Transportation Program

7.1.3.1 General

The Surface Transportation Program (STP) is a flexible funding program that provides Federal funds for:

- highway projects on all functional classes (except facilities functionally classified as “local”),
- bridge projects on any public road (including “local” functional classes),
- transit capital projects, and
- public bus terminals and facilities.

The basic objective of STP is to provide Federal-aid for improvements to facilities not considered to have significant national importance (i.e., facilities not on the NHS) and to minimize the Federal requirements for funding eligibility. The Federal funds allocated to STP are comparable to those funds previously designated for use on the former Federal-aid primary, Federal-aid urban and Federal-aid secondary systems. STP funds are distributed to each State based on its lane-miles of Federal-aid highways, total vehicle-miles traveled on those highways, and estimated contributions to the Highway Trust Fund.

STP expands and clarifies activities such as environmental provisions, modifications to meet ADA requirements, infrastructure-based intelligent transportation system capital improvements, and privately owned inter-city bus terminals and facilities.

A State’s STP allocation is further subdivided into the following subsections.

7.1.3.2 Urban

Urban areas receive an STP suballocation based on the State’s urban population. Urban areas are those areas identified by the U.S. Bureau of Census as having a contiguous population of 50,000 or more (urbanized areas) or 5000 or more but less than 50,000 (small urban areas). The urban area boundaries are established by the State, in cooperation with the Metropolitan Planning Organizations (MPOs) and local officials, and approved by FHWA. For the STP urban suballocation (STU), the distribution formula segregates urban population densities into three categories: less than 50,000, between 50,001 and 200,000, and more than 200,000. The urban STP suballocation provides specific funding amounts for each urban area nationwide with populations exceeding 200,000. There are four metropolitan areas in South Carolina meeting the 200,000-population level — Augusta Regional Transportation Study (ARTS), Charleston Area Transportation Study (CHATS), Columbia Area Transportation Study (COATS) and Greenville Area Transportation Study (GRATS).

Other MPOs in the State that may have funding available to them include the following:

- Anderson Area Transportation Study (ANATS),
- Florence Area Transportation Study (FLATS),
- Grand Strand Area Transportation Study (GSATS),
- Rock Hill/Fort Mill Area Transportation Study (RFATS),

- Spartanburg Area Transportation Study (SPATS), and
- Sumter Area Transportation Study (SUATS).

7.1.3.3 Rural

Rural areas are all areas outside of urbanized and small urban areas. FHWA determines a State's STP rural suballocation (STR) using a distribution formula based on the following factors:

- non-urban areas based on square miles (30 percent),
- non-urban population between 0 and 5000 (30 percent), and
- non-urban mileage systems (30 percent).

The remaining 10 percent of the STP rural suballocation is divided equally among the 50 states. A State can spend up to 15 percent of the rural STP suballocation on rural minor collectors.

7.1.3.4 Bridges

STP funds, at the discretion of the State DOT, may be used to replace or rehabilitate bridges (which meet the definition of a bridge) on any public road. Allowing STP funding for bridgework is intended to reduce the number of deficient bridges on the deficient/HBRRP eligibility list. See [Section 7.1.4](#) for a discussion on other Federal-aid funds available for bridge projects.

7.1.3.5 Safety

Under STP, 10 percent of the funds are set aside for safety construction activities, which is allocated before all other STP suballocations (e.g., STU, STR). Safety projects generally fall within two categories:

1. Hazard Elimination Projects. These are intended to correct a specific deficiency at a given highway location that generally has a high or disproportionate number of crashes or crash rates. The deficiencies may be related to structural, geometric, safety, drainage or traffic control problems. The Department selects eligible hazard elimination projects on the State Highway System based on a cost/benefit analysis, which sets priorities to realize the greatest overall reduction in crashes from the available safety funds.
2. Rail Safety Projects. These include crossing, signalization or approach work at railroad/highway grade crossings. The Department selects eligible rail safety projects on the State Highway System based on a Hazard Index at the crossing.

7.1.3.6 Transportation Enhancements

Under STP, 10 percent of the funds are set aside for transportation enhancements (TE), which is allocated before all other STP suballocations (e.g., STU, STR). Transportation enhancements encompass a broad range of environmentally related activities, but they must relate to surface transportation. Projects can include, but are not limited to:

- providing facilities or safety and educational activities for pedestrians and bicyclists;
- acquiring scenic easements and scenic or historic sites related to transportation;
- creating or expanding scenic or historic highway programs (including providing tourism or welcome center facilities);
- landscaping and other scenic beautification;
- historic preservation of transportation-related facilities;
- rehabilitation and operation of historic transportation buildings, structures or facilities (including historic railroad facilities and canals);
- preserving abandoned railway corridors (including converting the corridors to pedestrian or bicycle trails);
- control and removal of outdoor advertising;
- archeological planning and research;
- addressing environmental problems such as water pollution from highway runoff or protecting wildlife by providing safe highway-crossing methods; and
- establishment of transportation museums.

The Department is responsible for determining which projects are eligible for TE funding.

7.1.4 Bridges

7.1.4.1 General

A bridge is defined as any structure 20 feet or greater in length measured along the roadway. The Federal-aid highway program provides funds for highway bridges through several categorical sources. These are discussed in the following sections. Note that, as discussed in [Section 7.1.4.4](#), STP funds are also available for bridge projects on any public road.

7.1.4.2 Highway Bridge Replacement and Rehabilitation Program

The Highway Bridge Replacement and Rehabilitation Program (HBRRP) provides funds for eligible bridges located on any public road. This Program is the cornerstone of FHWA's efforts to correct, on a priority basis, deficient bridges throughout the nation. The number of structurally deficient and/or functionally obsolete bridges in South

Carolina compared to the number nationwide basically determines South Carolina's share of HBRRP funds.

HBRRP funds available to non-State highway facilities is based on the provision that no less than 15 percent and no more than 35 percent of the funds must be used on public roads that are functionally classified as local roads (urban and rural) or rural minor collectors.

7.1.4.3 Major Bridge Program

The Major Bridge Program is a subset of the Highway Bridge Replacement and Rehabilitation Program, and there is a special provision to use a portion of these funds for the seismic retrofit of bridges. The Major Bridge Program allocates funds for bridges that may be either on or off the State Highway System that have estimated construction costs exceeding \$1,000,000.

7.1.4.4 Discretionary Bridge Program

The Discretionary Bridge Program (DBP) is a Federal program that is designed to replace or rehabilitate deficient, high-cost highway bridges on Federal-aid highways. Eligible projects are those with construction costs exceeding \$10 million or exceeding twice the amount allocated to a State for the fiscal year under 23 USC Section 144. Projects nationwide are ranked according to a Rating Factor based on a variety of factors (e.g., Sufficiency Rating, traffic volumes, importance to national defense, project costs). These are bridges that are so expensive to replace or rehabilitate that, for a State DOT to use its annual HBRRP appropriation; it would exhaust the HBRRP funds.

7.1.4.5 Innovative Bridge Research and Construction Program

The Innovative Bridge Research and Construction Program is a discretionary program that promotes the use of innovative materials technology in the construction of bridges and other structures. The Program is a subset of the Technology Deployment Initiatives and Partnerships (TDIP) Program. The TDIP is intended to accelerate the adoption of innovative technologies.

7.1.4.6 National Historic Covered Bridge Preservation Program

Under the National Historic Covered Bridge Program, funds are authorized for the preservation and rehabilitation of historic covered bridges. The United States Secretary of Transportation, in cooperation with the States, is required to develop educational and research programs on covered bridge history and to research alternative preservation

techniques to protect historic bridges. The State of South Carolina has approximately 50 historic bridges eligible for the Program.

7.1.5 Federal Lands Highways

The Federal Lands Highways (FLH) Program provides funding for the following:

- park roads and parkways;
- Indian Reservation Roads (IRR), provided that the fund allocation and procedures for the IRR Program have been negotiated with Indian tribal governments;
- improving deficient bridges on IRRs;
- transit facilities within the public lands, national parks and Indian reservations;
- public lands highways (discretionary and forest highways); and
- refuge roads, defined as Federally owned public roads providing access to or within the National Wildlife Refuge System.

7.1.6 Emergency Relief

The Emergency Relief (ER) Program provides funding to assist State and local governments with the expense of repairing serious damage to Federal-aid highways that have resulted from natural disasters or catastrophic failures. ER funds may only be used for emergency repairs to restore essential highway traffic, to minimize damage resulting from a natural disaster or catastrophic failure, or to protect the remaining facility and make permanent repairs. If ER funds are exhausted, the United States Secretary of Transportation may borrow funds from other highway programs.

7.1.7 Congestion Mitigation and Air Quality Improvement

The Congestion Mitigation and Air Quality Improvement (CMAQ) Program provides a flexible funding source to State and local governments for transportation projects and programs designed to help meet the requirements of the *Clean Air Act*. Funding is available to areas that do not meet the National Ambient Air Quality Standards. These are considered non-attainment areas. Funding is also available to areas that were previously in non-attainment but are now in compliance. These are referred to as maintenance areas. Funds are distributed to States based on a formula that considers an area's population by county and the severity of its air quality problems within the non-attainment and maintenance areas. Greater weight is given to carbon monoxide non-attainment and maintenance areas. Eligible activities for funding include:

- transit improvements,
- travel demand management strategies,

- traffic flow improvements, and
- public fleet conversions to cleaner fuels.

7.1.8 National Scenic Byways Programs

Funds are allocated for technical assistance and grants to States to develop scenic byway programs and undertake related projects along roads designated as National Scenic Byways, All-American Roads or State Scenic Byways. These are routes that have scenic, cultural, national, recreational or archeological qualities. South Carolina currently has three designated National Scenic Byways — Cherokee Foothills Scenic Highway, Savannah River Scenic Highway and Ashley River Road.

7.2 STATE FUNDING

7.2.1 Federal-Aid Matching Funds

With few exceptions, all Federal-aid funding requires State (or local) matching funds. These matching funds are provided by the State of South Carolina for the Federal-aid program.

7.2.2 State Programs

Historically, the State of South Carolina has implemented transportation initiatives that provided 100 percent State funding. These initiatives occur intermittently on demand when a special need arises.

7.2.3 “C” Fund Program

The “C” Fund Program, which was initiated in 1946, provides State money for funding improvements to local and State roads. The Program is administered by the “C” Project Development Section, which has published an informational brochure, *The C Program*. The following briefly summarizes the operation of the Program; contact the “C” Project Development Section for more information:

1. Funding Source. “C” funds are derived from 2.66 cents/gallon of the State gas tax plus an annual allocation of \$9.5 million from the State Highway Fund, which is for distribution to donor counties. “C” funds are distributed to the counties based on a county’s land area, population and rural road mileage.
2. Local Administration. Each county has established a County Transportation Committee (CTC) to administer the “C” funds.
3. Program Administration. Each CTC chooses to administer the “C” Fund Program itself or requests SCDOT to administer the Program. Administration refers to financial management, accounting and record keeping.
4. Eligible Expenditures. These primarily include the costs of program administration and the costs for the engineering, construction and field contract management for eligible projects.
5. Project Types. Generally, these may be one of two types:
 - State road projects (i.e., those located on the State Highway System); or
 - local paving projects (i.e., those not on the State Highway System).

State road projects also include roads not currently on the State Highway System, but which are being proposed for addition to the State Highway System.

7.3 JURISDICTIONAL SYSTEMS

The State of South Carolina contains approximately 66,167 miles of public roads and streets. The network has been classified into several systems based on the responsible organization for highway and street improvement, for maintenance and for traffic enforcement.

7.3.1 State Highway System

The State Highway System consists of all highways under the jurisdiction of the South Carolina Department of Transportation. The system equals approximately 65 percent or 41,518 miles of all public highways in South Carolina. In general, these routes are the most important highways in the State, carry the greatest traffic volumes and operate at the highest speeds. Seven State highway districts perform maintenance work on the State system.

7.3.2 County Road System

South Carolina has 46 counties. The county governments are responsible for all rural roads within their boundaries that are not on the State or Municipal Highway System. There are 22,400 (±) miles of county-maintained roads in South Carolina.

7.3.3 Municipal System

The municipal system consists of urban roads and local city streets within the corporate limits that are not on the State Highway or County Road Systems. The extension of these routes outside the corporate limits, but still within the urban area, is the responsibility of the county.

7.3.4 Federal Lands

The Federal Lands Highway Program provides access to and within national forests, national parks, Indian reservations and other public lands by preparing plans, letting contracts, supervising construction facilities and conducting bridge inspections and surveys. Sumter National Forest and Francis Marion National Forest are Federal lands with roads maintained by SCDOT.

7.3.5 National Network (for Trucks)

The *Surface Transportation Assistance Act* (STAA) of 1982 required that the U.S. Secretary of Transportation, in cooperation with the State highway agencies, designate

a national network of highways that allow the passage of trucks of specified dimensions and weight. The objective of the STAA is to promote uniformity throughout the nation for legal truck sizes and weights on a National Network. The Network includes all Interstate highways and significant portions of the former Federal-aid primary system built to accommodate large-truck travel. In addition, the STAA requires that “reasonable access” be provided along other routes for the STAA commercial vehicles from the National Network to terminals and to facilities for food, fuel, repair and rest and, for household goods carriers, to points of loading and unloading.

In South Carolina, the National Network includes the Interstate Highway System and the facilities listed in [Figure 7.3A](#). SCDOT has defined “reasonable access” as 1 mile from any interchange on the National Network.

Route	From	To
US 15/401	NC State Line	US 52 Society Hill
US 17	I-95 Pocotaligo	US 21 Gardens Corner
US 17	I-26 Charleston	NC State Line
US 21	US 17 Gardens Corner	SC 170 Beaufort
US 25	NC State Line	US 78 North Augusta (via Greenwood Bypass)
US 52	US 15/401 Society Hill	End of 4-lane divide North of urban limits of Kingstree
US 52	US 17 Alt. S. Int. Moncks Corner	I-26 Exit 208 N. Charleston connector
US 76	US 52 Florence	SC 576 Marion
US 76	SC 277 Columbia	I-126 Columbia
US 78	GA State Line	I-95 St. George
US 78	I-26 Exit 205 N Charleston	US 52 N Charleston
US 123	Bibb St Westminster	US 25 Greenville
US 21/178 Bypass	US 601 Orangeburg	Orangeburg
US 276	I-385 Simpsonville	I-85 Greenville
US 301	US 321 Ulmer	I-95 Santee
US 321	I-26 S. of Columbia	I-95 Hardeeville
US 378	SC 262 Columbia	US 501 Conway
US 501	SC 576 Marion	US 17 Myrtle Beach
US 601	NC State Line	SC 151 Pageland
US 601	I-26 Jamison	US 21/178 Bypass Orangeburg
SC 72	US 25 Bypass Greenwood	I-77 Exit 61 (via SC 72 Bypass – US 21 BR – US 21 Rock Hill)
SC 121	SC 72 Whitmire	US 25 Trenton
SC 151	US 601 Pageland	US 52 Darlington
SC 277	I-77 Columbia	US 76 Columbia
SC 576	US 76 Marion	US 501 Marion

**NATIONAL NETWORK IN SOUTH CAROLINA
(Non-Interstate Routes)**

Figure 7.3A

Chapter Eight
RESERVED

Table of Contents

<u>Section</u>	<u>Page</u>
9.1	DEFINITIONS..... 9.1(1)
9.1.1	Qualifying Words 9.1(1)
9.1.2	Acronyms 9.1(3)
9.2	ADHERENCE TO GEOMETRIC DESIGN CRITERIA..... 9.2(1)
9.2.1	Department Intent..... 9.2(1)
9.2.2	Design Exceptions..... 9.2(1)
9.2.3	Project Application..... 9.2(2)
9.2.4	Documentation 9.2(2)
9.2.5	Procedures 9.2(3)
9.3	PROJECT SCOPE OF WORK 9.3(1)
9.3.1	New Construction 9.3(1)
9.3.2	Reconstruction 9.3(1)
9.3.3	3R Projects (Non-Freeways) 9.3(1)
9.3.4	3R Projects (Freeways) 9.3(2)
9.3.5	Spot Improvements 9.3(3)
	9.3.5.1 Safety Projects 9.3(3)
	9.3.5.2 HBRRP Projects..... 9.3(4)
	9.3.5.3 Special Projects 9.3(4)
9.4	HIGHWAY SYSTEMS 9.4(1)
9.4.1	Functional Classification..... 9.4(1)
	9.4.1.1 Relationship to Design 9.4(1)
	9.4.1.2 Arterials 9.4(1)
	9.4.1.3 Collectors 9.4(2)
	9.4.1.4 Local Roads and Streets 9.4(2)
9.4.2	Route Concept Report..... 9.4(2)
9.4.3	Geographic Classifications 9.4(3)
9.5	SPEED 9.5(1)
9.5.1	Definitions..... 9.5(1)
9.5.2	Design Speed Selection 9.5(2)

Table of Contents

(Continued)

<u>Section</u>	<u>Page</u>
9.6	TRAFFIC VOLUME CONTROLS 9.6(1)
9.6.1	Definitions..... 9.6(1)
9.6.2	Design Year Selection 9.6(2)
9.6.2.1	Roadway Design 9.6(2)
9.6.2.2	Other Highway Elements..... 9.6(3)
9.6.3	Design Hourly Volume Selection 9.6(4)
9.6.3.1	Selection 9.6(4)
9.6.3.2	Factors Affecting DHV Determinations..... 9.6(4)
9.6.4	Capacity Analyses 9.6(6)
9.6.4.1	Level of Service..... 9.6(6)
9.6.4.2	Objective 9.6(6)
9.7	DESIGN VEHICLES 9.7(1)
9.8	ACCESS MANAGEMENT/ACCESS CONTROL 9.8(1)
9.8.1	Definitions..... 9.8(1)
9.8.2	Access Management..... 9.8(2)
9.8.3	Procedures..... 9.8(3)
9.8.4	Criteria..... 9.8(3)
9.8.4.1	Intersections 9.8(3)
9.8.4.2	Interchanges 9.8(5)
9.9	FHWA OVERSIGHT AND INVOLVEMENT..... 9.9(1)
9.9.1	Background 9.9(1)
9.9.2	Project Oversight..... 9.9(1)
9.9.2.1	Oversight..... 9.9(1)
9.9.2.2	Laws and Regulations..... 9.9(3)
9.9.2.3	Obligation of Funds 9.9(3)
9.9.2.4	Certification 9.9(3)

Table of Contents

(Continued)

<u>Section</u>		<u>Page</u>
9.10	CONTEXT SENSITIVE DESIGN.....	9.10(1)
9.10.1	Background	9.10(1)
9.10.2	Principles.....	9.10(1)
9.11	DESIGN CONSISTENCY AND DRIVER EXPECTANCY.....	9.11(1)
9.12	REFERENCES.....	9.12(1)

Chapter Nine

BASIC DESIGN CONTROLS

Road design is predicated on many basic controls that establish the overall objective of the highway facility and identify the basic purpose of the highway project. This Chapter presents these basic controls that impact highway design. It includes a discussion on the design exception process, project scope of work, highway classification, speed, traffic volume controls, design vehicles, access control/management, FHWA involvement and context sensitive design. The application of these items to a project will impact all elements of highway design.

9.1 DEFINITIONS

9.1.1 Qualifying Words

Many qualifying words are used in highway design and in this *Manual*. For consistency and uniformity in the application of various design criteria, the following definitions apply:

1. Shall, Require, Will, Must. A mandatory condition. Designers are obligated to adhere to the criteria and applications presented in this context or to perform the evaluation indicated. For the application of geometric design criteria, this *Manual* limits the use of these words.
2. Should, Recommend. An advisory condition. Designers are strongly encouraged to follow the criteria and guidance presented in this context, unless there is reasonable justification not to do so.
3. May, Could, Can, Suggest, Consider. A permissive condition. Designers are allowed to apply individual judgment and discretion to the criteria when presented in this context. The decision will be based on a case-by-case assessment.
4. Desirable, Preferred. An indication that the designer should make every reasonable effort to meet the criteria and that he/she should only use a “lesser” value after due consideration of the “better” value.
5. Ideal. Indicating a standard of perfection (e.g., traffic capacity under “ideal” conditions).
6. Minimum, Maximum, Upper, Lower (Limits). Representative of generally accepted limits within the design community but not necessarily suggesting that these limits are inviolable. However, where the criteria presented in this context will not be met, the designer will in many cases need approval.

7. Practical, Feasible, Cost-Effective, Reasonable. Advising the designer that the decision to apply the design criteria should be based on a subjective analysis of the anticipated benefits and costs associated with the impacts of the decision. No formal analysis (e.g., cost-effectiveness analysis) is intended, unless otherwise stated.
8. Possible. Indicating that which can be accomplished. Because of its rather restrictive implication, this word will rarely be used in this *Manual* for the application of design criteria.
9. Significant, Major. Indicating that the consequences from a given action are obvious to most observers and, in many cases, can be readily measured.
10. Insignificant, Minor. Indicating that the consequences from a given action are relatively small and not an important factor in the decision making for highway design.
11. Warranted, Justified. Indicating that some well-accepted threshold or set of conditions has been met. As used in this *Manual*, “warranted” or “justified” may apply to either objective or subjective evaluations. Note that, once the warranting threshold has been met, this is an indication that the design treatment should be considered and evaluated — not that the design treatment is automatically required.
12. Standard. Indicating a design value that should not be violated without consequences. This suggestion is generally inconsistent with geometric design criteria. Therefore, “standard” will not be used in this *Manual* to apply to geometric design criteria.
13. Guideline. Indicating a design value that establishes an approximate threshold that should be met if considered practical.
14. Criteria. A term typically used to apply to design values, usually with no suggestion on the criticality of the design value. Because of its basically neutral implication, this *Manual* frequently uses “criteria” to refer to the design values presented.
15. Typical. Indicating a design practice that is most often used in application.
16. Acceptable. Design criteria that may not meet desirable values, but yet is considered to be reasonable and safe for design purposes.
17. Policy. Indicating SCDOT practice that the Department expects the designer to follow, unless otherwise justified.

9.1.2 Acronyms

The following are common acronyms for the major national agencies and publications used in highway design:

1. AASHTO. American Association of State Highway and Transportation Officials.
2. CFR. *Code of Federal Regulations*.
3. FEMA. Federal Emergency Management Agency.
4. FHWA. Federal Highway Administration.
5. HCM. *Highway Capacity Manual*.
6. ITE. Institute of Transportation Engineers.
7. ISTEA. *Intermodal Surface Transportation Efficiency Act of 1991*.
8. MUTCD. *Manual of Uniform Traffic Control Devices*.
9. NCHRP. National Cooperative Highway Research Program.
10. NHS. National Highway System.
11. SCDOT. South Carolina Department of Transportation.
12. STP. Surface Transportation Program.
13. TEA-21. *Transportation Equity Act for the 21st Century*.
14. TRB. Transportation Research Board.
15. TRR. Transportation Research Record.
16. USC. *United States Code*.
17. USDOT. United States Department of Transportation.

9.2 ADHERENCE TO GEOMETRIC DESIGN CRITERIA

The *South Carolina Highway Design Manual* presents numerous criteria on road design for application on individual road design projects. In general, the designer is responsible for making every reasonable effort to meet these criteria in the project design. However, this will not always be practical. This Section discusses the Department's procedures for identifying, justifying and processing exceptions to the geometric design criteria in the *Highway Design Manual*.

9.2.1 Department Intent

The general intent of the South Carolina Department of Transportation is that all road design criteria in this *Manual* should be met and, wherever practical, the proposed design should exceed the minimum criteria. The Department's intent is to provide a highway system that meets the transportation needs of the State while insuring an acceptable level of safety, comfort and convenience for the traveling public.

9.2.2 Design Exceptions

Recognizing that meeting the minimum criteria may not always be practical, the Department has established a process to identify, evaluate and approve exceptions to geometric design criteria. This Section presents those design elements that require a design exception when the proposed design does not meet the applicable criteria. The "controlling" design criteria are highway elements that are judged to be the most critical indicators of a highway's overall safety and serviceability.

The designer must seek a FHWA and/or SCDOT design exception when the proposed design includes any of the following elements that do not meet the following criteria:

- design speeds;
- horizontal alignment elements:
 - + minimum radii, and
 - + sight distance at curves based on level stopping sight distance (SSD);
- vertical alignment elements:
 - + K-values based on level SSD for crest and sag vertical curves,
 - + maximum grades, and
 - + vertical clearances (without clearance for future overlay);
- travel lane and shoulder widths;
- cross slopes for travel lanes and shoulders;

- superelevation rates;
- clear roadway bridge widths;
- structural capacity of bridges;
- horizontal clearances to obstructions; and
- stopping sight distances.

9.2.3 Project Application

The design exception process applies to all capital improvement projects considered new construction and reconstruction. It does not apply to spot improvement projects. Note that, for both new construction and reconstruction, the list of design elements that require an exception when not met ([Section 9.2.2](#)) is identical. However, the numerical threshold will vary accordingly to the project scope of work.

As noted in [Section 9.9](#), requests for design exceptions will be submitted by the Director of Preconstruction to FHWA for all new construction/reconstruction projects on Interstates and for projects on NHS routes that exceed \$50 million. The request for design exceptions will be processed internally within SCDOT for all other projects. See [Section 9.2.5](#).

9.2.4 Documentation

The type and detail of the documentation needed to justify a design exception will be determined on a case-by-case basis. The following lists potential factors that may be addressed in the documentation for a specific design exception:

- amount and character of the current and design year traffic;
- serviceability impacts (e.g., traffic level of service);
- number and type of crashes, fatal crash rate and fatal crash rate on a comparable system;
- project's compatibility with adjacent sections of roadway (e.g., comparisons of lane widths, shoulder width, slopes, curvature);
- probable timing for scheduled future improvements within the proposed project limits;
- cost analysis (maximum service and safety benefits for dollars invested);
- environmental considerations;
- right of way costs and impacts; and
- assessment of the structural and functional adequacy of existing bridges.

9.2.5 Procedures

A design exception may be identified at any time during the development of the project. The project development process specifies opportunities when design exceptions should be identified. Identification of design exceptions is, also, included in the quality control review of the project plans.

When a design exception is identified by the **Engineer of Record** or any Project Development Team member, the Engineer of Record will first seek to eliminate the exception to design. If the design exception cannot be removed, then the Engineer of Record will initiate the formal design exception approval process. The request for approval of the design exception will be submitted to the Program Manager **for routing to the appropriate personnel for the record of decision**. The Design Exception Request will include the request form (see [Figure 9.2A](#)) and any support data needed to justify the reason why the exception cannot be eliminated through the design process including design alternatives. The request for approval will be prepared for a design exception to AASHTO guidelines and/or for a design exception from standard SCDOT procedures.

Request for Approval of Design Exceptions can be approved only by the Director of Preconstruction. On projects requiring oversight approval by the Federal Highway Administration, the Director of Preconstruction submits the approved Design Exception Request to FHWA for their concurrence.

Submitted By: _____ Date: __/__/__ Recommended: _____ Date: __/__/__

 Engineer of Record

To: _____
 Program / Project Manager

BASIS OF DESIGN EXCEPTION

- Request for Approval of Design Exceptions to AASHTO Guidelines
- Request for Approval of Design Exceptions from Standard SCDOT Procedures

PROJECT CHARACTERISTICS

County: _____ Rd./Route: _____ Const. Pin: _____
 From: _____ To: _____
 Length: _____ (miles) MPO/COG _____
 Work Type: _____
 Functional Classification: _____

Group Designation: (1 / 2 / 3 / 4) (if applicable)

Type of Terrain: (Level / Rolling / Mountainous)

Design Speed: _____ (mph)

_____ ADT _____

_____ ADT _____

Trucks _____ %

CRASH ANALYSIS

(Attach additional sheets with accident history data)

TOTAL PROJECT ESTIMATE (\$) _____

CHECK APPROPRIATE BOX(ES) FOR DESIGN EXCEPTION(S)

- | | | |
|---|--|--|
| <input type="checkbox"/> Design Speed | <input type="checkbox"/> Maximum Grade | <input type="checkbox"/> Travel Lane Width |
| <input type="checkbox"/> Horizontal Alignment | <input type="checkbox"/> Vertical Clearance | <input type="checkbox"/> Shoulder Width |
| <input type="checkbox"/> Minimum Radii | <input type="checkbox"/> Bridge Width | <input type="checkbox"/> Horizontal Clearances |
| <input type="checkbox"/> Vertical Alignment | <input type="checkbox"/> Structural Capacity | <input type="checkbox"/> Stopping Sight Distance |
| <input type="checkbox"/> Level SSD K-Values | <input type="checkbox"/> Superelevation Rate | |
| | <input type="checkbox"/> Cross Slope | |
| | <input type="checkbox"/> Travel Lanes | |
| | <input type="checkbox"/> Shoulders | |

DESCRIBE ELEMENT(S) FOR DESIGN EXCEPTION(S)

(Attach additional Sheets as needed) _____

DESIGN EXCEPTION FORM

JUSTIFICATION FOR DESIGN EXCEPTION(S)

(Attach additional Sheets as needed) _____

DESCRIBE STEPS TO ELIMINATE DESIGN EXCEPTION(S), INCLUDE COST

(Attach additional Sheets as needed) _____

HOW WILL FUTURE CONSTRUCTION IMPACT DESIGN EXCEPTION(S)?

(Attach additional sheets as needed) _____

RECORD OF DECISION

- For
- Against

- For
- Against

- Approved
- Denied

_____/_____/_____
Regional Design Manager/
Program Manager / DEA)

_____/_____/_____
Regional Production Engineer

_____/_____/_____
(Director of Preconstruction)

- Concur

_____/_____/_____
FHWA (NHS Routes > \$50 million & All Interstate)

- cc:
- Director of Preconstruction
 - FHWA
 - Preconstruction Support Engineer
 - Regional Production Group Engineer
 - District Engineering Administrator
 - Director of Traffic Engineering

Revised record of decision– Revised: 11-2007

DESIGN EXCEPTION FORM

(Continued)

Figure 9.2A

9.3 PROJECT SCOPE OF WORK

The project scope of work will reflect the basic intent of the highway project and will determine the overall level of highway improvement. This decision, in combination with the highway functional classification (see [Section 9.4.1](#)), will determine which criteria in the *Manual* apply to the geometric design of the project. The following provides general definitions for the project scope of work, and it references the applicable chapters in Part III for the design criteria based on the project scope of work.

9.3.1 New Construction

Generally, new construction is defined as horizontal and vertical alignment on new location. The development is based on a 20-year design period beginning from the date the facility is opened. The project will be logical in scope and have logical termini. Where a facility is on new location and has a new alignment, it is considered new construction. In addition, new construction also includes any new intersection or interchange that falls within the project limits of a new or existing highway mainline or is relocated to a new point of intersection. [Chapters 19 through 22](#) present SCDOT criteria for new construction.

9.3.2 Reconstruction

Reconstruction of an existing highway will typically include the addition of travel lanes, reconstructing of the existing horizontal and vertical alignment, widening the roadway and flattening side slopes, but the highway will remain essentially within the existing highway corridor. Where an existing two-lane, two-way facility becomes a multilane facility with a rural-type median, the new median and proposed roadway are considered reconstruction. These projects will usually require some right of way acquisitions. The primary reasons for reconstructing an existing highway are because the facility cannot accommodate its current or future traffic demands, the existing alignment or cross section is deficient and/or the service life of the pavement has been exceeded. In addition, any intersection that falls within the limits of a reconstruction project will be reconstructed as needed.

Because of the significant level of work for reconstruction, the design of the project generally will be determined by the criteria for new construction based on a 20-year design period. The criteria in [Chapters 19 through 22](#) will apply to reconstruction projects.

9.3.3 3R Projects (Non-Freeways)

3R projects (rehabilitation, restoration and/or resurfacing) on non-freeways are primarily intended to extend the service life of the existing facility and to enhance highway safety.

In addition, 3R projects should make cost-effective improvements to the existing geometrics, where practical. 3R work on the mainline or at an intersection is typically work within the existing alignment. However, right of way acquisition is sometimes justified for flattening slopes, changes in horizontal alignment, changes in vertical profile and safety enhancements.

The overall objective of a 3R non-freeway project is to perform work necessary to return the highway to a condition of acceptable structural and/or functional adequacy. 3R projects may include any number of the following types of improvements:

- providing pavement resurfacing, pavement rehabilitation and/or pavement reconstruction;
- providing lane and/or shoulder widening (without adding through lanes);
- adding a two-way, left-turn lane (TWLTL);
- providing intersection improvements (e.g., adding turn lanes, lengthening turn lanes, flattening turning radii, channelization, minor realignment, corner sight distance improvements);
- flattening a horizontal or vertical curve;
- adding auxiliary lanes (e.g., truck-climbing lane);
- adding curb and gutter to an existing urban street;
- removing, widening and/or resurfacing parking lanes;
- upgrading at-grade highway/railroad crossings;
- revising the location, spacing or design of existing driveways along the mainline;
- rehabilitating and/or widening existing bridges;
- upgrading guardrail and other roadside safety appurtenances to meet current criteria;
- relocating utility poles;
- providing and/or upgrading traffic control devices;
- adjusting the roadside clear zone;
- flattening side slopes;
- providing drainage improvements; and/or
- implementing improvements to meet the Department's accessibility criteria (e.g., sidewalks and sidewalk curb ramps).

Any of the above may also be an element of work for a reconstruction project. Chapter 23 presents SCDOT procedures for the design of 3R non-freeway projects.

9.3.4 3R Projects (Freeways)

3R projects (resurfacing, restoration and/or rehabilitation) on existing freeways are primarily intended to extend the service life of the existing facility and to enhance highway safety. In addition, these projects should make cost-effective improvements to

the existing geometrics, where practical. 3R freeway projects may include any number of the following types of improvements:

- providing pavement resurfacing, pavement rehabilitation, and/or pavement reconstruction;
- realigning or widening an existing ramp or modifying an existing interchange;
- lengthening existing acceleration or deceleration lanes at freeway entrances and exits;
- improvements to interchange gore areas;
- flattening a horizontal or vertical curve;
- adding auxiliary lanes (e.g., truck-climbing lane);
- rehabilitating and/or widening existing bridges;
- upgrading guardrail and other roadside safety appurtenances to meet current criteria;
- adjusting the roadside clear zone;
- flattening side slopes; and/or
- providing drainage improvements.

9.3.5 Spot Improvements

Spot improvements are intended to correct an identified deficiency at an isolated location. The deficiency may be related to structural, geometric, safety, drainage or traffic control problems. These projects are not intended to provide a general upgrading of the highway, as are projects categorized as new construction, reconstruction or 3R.

9.3.5.1 Safety Projects

Safety projects are improvements intended to correct isolated highway deficiencies at locations where high crash or severity rates can be substantiated or where a high potential for crashes exists. The process of identifying hazardous locations, plus the procedures for selecting and developing a prioritized listing of projects for improvements, is discussed in the *SCDOT Highway Safety Improvement Program Manual*.

Roadway and bridge deficiencies may be related to structural, geometric, safety, drainage, or traffic control problems. It is not the intent of the safety improvement project to provide for general upgrading of highways. The selected criteria should be based on sound engineering assessments of conditions at the particular site. In general, the objective is to improve the problem area to a level of driver expectancy equivalent to that of adjacent sections of roadway.

Safety improvements may include intersection improvements, flattening horizontal and vertical curves, replacing or rehabilitating obsolete bridge rails and guardrails, flattening side slopes, removing roadside obstacles, resurfacing, improving railroad crossings,

correcting pavement drop-offs, improving signing, pavement markings and/or other traffic control devices.

Safety projects are generally developed and managed by the Traffic Engineering Division.

9.3.5.2 HBRRP Projects

These are bridge improvement projects funded by the Highway Bridge Replacement and Rehabilitation Program (HBRRP). For guidance on HBRRP projects, see [Section 7.1.4](#).

HBRRP projects are generally developed and managed by the Bridge Design Section.

9.3.5.3 Special Projects

These are projects that generally do not qualify as a “safety improvement” project as defined in [Section 9.3.5.1](#) and usually require State funding. Special projects are often site specific and design criteria must be tailored to meet the needs of the project. Typical projects may include adding turn lanes, providing by-pass lanes, removing roadside obstacles, etc. In some instances, special projects are implemented with the Department’s Maintenance forces. These improvements should be coordinated with the Director of Maintenance and the District Engineering Administrator.

9.4 HIGHWAY SYSTEMS

9.4.1 Functional Classification

9.4.1.1 Relationship to Design

The functional classification concept is one of the most important determining factors in highway design. In this concept, highways are grouped by the character of service they provide. Functional classification recognizes that the public highway network in South Carolina serves two basic and often conflicting functions — travel mobility and access to property. Each highway or street will provide varying levels of access and mobility, depending upon its intended service. In the functional classification scheme, the overall objective is that the highway system, when viewed in its entirety, will yield an optimum balance between its access and mobility purposes. If this objective is achieved, the benefits to the traveling public will be maximized.

The functional classification system provides the guidelines for determining the geometric design of individual highways and streets. Once the function of the highway facility is defined, the designer can select an appropriate design speed, roadway width, roadside safety elements, amenities and other design values. The *SCDOT Highway Design Manual* is based upon this systematic concept to determine geometric design.

Road Data Services has functionally classified all public roads and streets within South Carolina that are maintained by the Department. For highway design, it is necessary to identify the predicted functional class of the road or street for the selected design year (e.g., 20 years beyond the project completion date). Road Data Services will provide this information to the designer.

There are three general categories within the functional classification system — arterials, collectors, and local roads and streets. The following sections provide brief definitions for these categories. The *AASHTO A Policy on Geometric Design of Highways and Streets* provides detailed information on functional classification.

9.4.1.2 Arterials

Arterial highways are characterized by a capacity to quickly move relatively large volumes of traffic. They are sometimes deliberately restricted in their service to abutting properties. The arterial functional class is subdivided into principal and minor categories for rural and urban areas:

1. Principal Arterials. In both rural and urban areas, the principal arterials provide the highest traffic volumes and the greatest trip lengths. The designer should review the project scope of work and planning documents to determine which of the following principal arterials should be used in the design and identify its corresponding criteria:

- a. Freeways. The freeway is the highest level of principal arterial. These facilities are characterized by full control of access, high design speeds and a high level of driver comfort and safety. For these reasons, freeways are considered a special type of highway within the functional classification system, and separate design criteria have been developed for them.
 - b. Urban/Rural Arterials. These facilities are usually two or four lanes with or without a median. Partial control of access is desirable along these facilities. A high level of geometric design is desirable to move the high traffic volumes quickly and efficiently through an area.
2. Minor Arterials. In rural areas, minor arterials will provide a mix of interstate and intercounty travel service. In urban areas, minor arterials may carry local bus routes and provide intercounty connections, but they will not, for example, penetrate neighborhoods. When compared to the principal arterial system, the minor arterials provide lower travel speeds, accommodate shorter trips and distances and lower traffic volumes but provide more access to property.

9.4.1.3 Collectors

Collector routes are characterized by a roughly even distribution of their access and mobility functions. Traffic volumes and speeds will typically be somewhat lower than those of arterials. In rural areas, collectors serve intercounty travel needs and provide connections to the arterial system. All cities and towns within a region will be connected. In urban areas, collectors act as intermediate links between the arterial system and points of origin and destination. Urban collectors typically penetrate residential neighborhoods and commercial and industrial areas. Local bus routes will often include collector streets.

9.4.1.4 Local Roads and Streets

All public roads and streets not classified as arterials or collectors will have a local classification. Local roads and streets are characterized by their many points of direct access to adjacent properties and their relatively minor value in accommodating mobility. Speeds and volumes are usually low and trip distances short. Through traffic is often deliberately discouraged.

9.4.2 Route Concept Report

The comprehensive urban transportation planning process has been in place for more than 40 years. The planning concept for urbanized areas (greater than 50,000 population) has, in some areas, been extended to small urban areas (5,000 to 50,000

population). Effectively, the future urban area highway and street development concept is determined, and periodic updates are made to modify the original plan concept as needed.

SCDOT has developed and used the “route concept report” as a method for evaluating routes on a statewide basis and for determining existing and forecasted deficiencies and needs.

Road Data Services is responsible for developing and updating route concept reports for all State highways in South Carolina. Each report contains the broad planning picture of an entire route through the State. Key elements of data are consolidated into a computerized database for each route. This data includes summaries, by county and route segment, of roadway geometrics, traffic volumes, levels of service, and crash history. Information related to access control, bridges and railroad crossings is also shown in the report.

This report assists in determining short- and long-term highway improvement needs. The needs ultimately form the basis of an improvement program, and specific design criteria are established for the proper design of a project.

9.4.3 Geographic Classifications

The functional classification system is divided into urban and rural categories. Urban areas are defined as those places within boundaries having a population of 5,000 or more. Urban areas are further subdivided into urbanized areas (population of 50,000 and over) and small urban areas (population between 5,000 and 50,000). Rural areas are those areas outside the boundaries of urban areas. For design purposes, the population forecast for the design year should be used.

In many cases, an urban/rural designation is not sufficiently specific to determine the appropriate project design. Therefore, SCDOT has adopted urban design classifications of “suburban” and “urban” to reflect the extent of roadside development. These designations are incorporated into the tables of geometric design criteria for new construction/reconstruction ([Chapters 19 through 22](#)) and for existing highways ([Chapter 23](#)). The designer should consider the following descriptions when selecting the applicable design classification for urban areas:

1. **Suburban**. These areas are usually located at the fringes of urbanized and small urban areas. The predominant character of the surrounding environment may be residential, but it will also typically include a considerable number of commercial establishments and especially strip commercial development. There may also be a few industrial parks in suburban areas. On suburban roads and streets, drivers usually have a significant degree of freedom but, nonetheless, they must also devote some of their attention to entering and exiting vehicles. Roadside

development is characterized by low to moderate density. Pedestrian activity may be a significant design factor. Right of way is often available for roadway improvements.

A typical suburban arterial may have strip commercial development and perhaps a few residential properties. Posted speed limits usually range between 35 and 50 miles per hour, and there may be several signalized intersections along an arterial.

Local and collector streets in suburban areas may be located in residential areas, but may also serve commercial areas. Posted speed limits typically range between 25 and 50 miles per hour. The majority of intersections will have stop or yield control, but there may be an occasional traffic signal.

2. Urban. These areas normally refer to the densely developed commercial areas. The roadside development is most often commercial on arterials. A substantial number of collector/local roads and streets in urban areas pass through a high-density, residential environment (e.g., apartment complexes, row houses). Access to property is the primary function of the highway network in urban areas; the average driver rarely passes through an urban area for mobility purposes. Pedestrian considerations may be important, especially at intersections. Right of way for roadway improvements is usually not available.

Because of the high density of development in urban areas, the distinction between the functional classes (local, collector or arterial) becomes less important when considering geometric design elements such as design speed. The primary distinction among the three functional classes is often the relative traffic volumes and, therefore, the number of lanes. As many as half the intersections may be signalized. Posted speed limits typically range between 25 and 45 miles per hour.

9.5 SPEED

9.5.1 Definitions

The following speed definitions are commonly used in highway design:

1. Design Speed. Design speed is a selected speed used to determine the various geometric design features of the highway. A design speed is selected for each project that will establish criteria for several design elements including horizontal and vertical curvature, superelevation and sight distance. In general, the speed relates to the driver's comfort and is not the speed at which a vehicle will lose control. [Section 9.5.2](#) discusses the selection of design speed in general. [Chapters 19 through 22](#) present specific design speed criteria for various conditions.
2. Low Speed. For geometric design purposes, low speed is defined as 45 miles per hour or less.
3. High Speed. For geometric design purposes, high speed is defined as greater than 45 miles per hour.
4. Average Running Speed. Running speed is the average speed of a vehicle over a specified section of highway. It is equal to the distance traveled divided by the running time (the time the vehicle is in motion). The average running speed is the distance summation for all vehicles divided by the running time summation for all vehicles.
5. Average Travel Speed. Average travel speed is the distance summation for all vehicles divided by the total time summation for all vehicles, including stopped delays. (Note: Average running speed only includes the time the vehicle is in motion. Therefore, on uninterrupted flow facilities that are not congested, average running speed and average travel speeds are equal.)
6. Free-Flow Speed. The average speed of vehicles on a given facility, measured under low-volume conditions when drivers tend to drive at their desired speed and are not constrained by control delay.
7. Operating Speed. Operating speed is the speed at which drivers are observed operating their vehicles during free-flow conditions. In practice, the term "operating speed" is commonly used to characterize prevailing vehicular speeds on a highway segment, either through field measurements of speed or through informal field observations. Although no precise percentile is used to define operating speed, the 85th percentile is frequently used to express the operating speed. The designer should note that the term "operating speed" has little or no usage in geometric design.

8. 85th-Percentile Speed. The 85th-percentile speed is the speed below which 85 percent of vehicles travel on a given highway. The most common application of the value is its use as one of the factors, and usually the most important factor, for determining the posted, legal speed limit of a highway section. In most cases, field measurements for the 85th-percentile speed will be conducted during off-peak hours when drivers are free to select their desired speed.
9. Pace. Pace is the range of speeds, typically stated in 10 miles per hour increments, in which the highest number of observations is recorded.
10. Posted Speed Limit. The posted speed limit on State highways is typically based on traffic and engineering investigations, where statutory requirements do not apply. The selection of a posted speed limit is based on several factors:
 - the design speed used during project development (posted speed is generally 5 miles per hour less than the design speed);
 - median type on multilane facilities;
 - the 85th-percentile speed and pace speed;
 - highway functional classification and type of area;
 - road surface characteristics, grade, alignment and sight distance;
 - type and density of roadside development;
 - use of curb and gutter;
 - the crash experience;
 - the need for traffic signal progression; and
 - parking practices and pedestrian and bicycle activity.

9.5.2 Design Speed Selection

The selected design speed is based on the following:

1. Functional Classification. In general, the higher class facilities are designed with a higher design speed than the lower class facilities.
2. Urban/Rural. Design speeds in rural areas are generally higher than those in urban areas. This is consistent with the typically fewer constraints in rural areas (e.g., less development).
3. Terrain. The flatter the terrain, the higher the selected design speed may be. Lower design speeds may be used to minimize the higher construction costs often associated with more rugged terrain.
4. Traffic Volumes. On some facilities, the design speed varies depending on traffic volumes.

5. Driver Expectancy. The selected design speed should be consistent with driver expectancy. The designer should consider the following when selecting a design speed:
 - avoid major changes in the design speed throughout the project limits;
 - where necessary, provide transitional design speeds between sections adjacent to the project;
 - do not place minimum radius horizontal curves at the end of long tangents; and
 - consider the expected posted speed in the selection of the design speed.
6. Range. Design speeds generally range from 15 to 75 miles per hour in 5 miles per hour increments.

For geometric design application, the relationship between these design elements and the selected design speed reflects general cost-effective considerations. The value of a transportation facility in carrying goods and people is judged by its convenience and economy, which are directly related to its speed. See [Chapters 19 through 22](#) for specific design speed criteria.

9.6 TRAFFIC VOLUME CONTROLS

9.6.1 Definitions

The following terms are commonly used in the discussion of traffic volumes in highway design:

1. Annual Average Daily Traffic (AADT). The total traffic volume passing a point or segment of a highway facility in both directions of travel for one year divided by the number of days in the year.
2. Average Daily Traffic (ADT). The total traffic volume passing a point or segment of a highway facility in both directions of travel during a time period greater than one day but less than one year divided by the number of days in that time period. Although not precisely correct, ADT is often used interchangeably with AADT.
3. Capacity. The maximum sustainable flow rate at which vehicles or persons reasonably can be expected to traverse a point or uniform segment of a lane or roadway during a given time period under prevailing roadway, traffic, environmental and control conditions. The time period most often used for analysis is 15 minutes.
4. Delay. The additional travel time experienced by a driver, passenger or pedestrian.
5. Density. The number of vehicles on a roadway segment averaged over space, usually expressed as vehicles per mile or vehicles per mile per lane.
6. Design Hourly Volume (DHV). The one-hour vehicular volume in both directions of travel in the design year selected for highway design. Note that, for capacity analyses, the DHV is typically converted to an hourly flow rate based on the maximum 15-minute flow rate during the DHV.
7. Directional Design Hourly Volume (DDHV). The peak one-hour volume in one direction of travel during the DHV.
8. Directional Distribution (D). The distribution, by percent, of the traffic in each direction of travel during the DHV, ADT and/or AADT.
9. Flow Rate. The equivalent hourly rate at which vehicles, bicycles or persons pass a point on a lane, roadway or other trafficway; computed as the number of vehicles, bicycles or persons passing the point, divided by the time interval (usually less than 1 hour) in which they pass. Expressed as vehicles, bicycles or persons per hour.
10. Level of Service (LOS). A qualitative measure describing operational conditions within a traffic stream, based on service measures such as speed and travel

time, freedom to maneuver, traffic interruptions, comfort and convenience. In the *Highway Capacity Manual*, the qualitative descriptions of each level of service (A through F) have been converted into quantitative measures for the capacity analysis for each highway element, including:

- freeway mainline,
- freeway mainline/ramp junctions,
- freeway weaving areas,
- two-lane rural highways,
- multilane rural highways,
- urban and suburban streets,
- signalized intersections,
- two-way stop intersections,
- all-way stop intersections,
- roundabouts, and
- interchange ramp terminals.

The *Highway Capacity Manual* also provides procedures for determining the level of service for transit, pedestrians and bicyclists. [Chapters 19 through 22](#) present guidelines for selecting the LOS for capacity analyses in road design.

11. K. The ratio of DHV to ADT. K will vary based on the hour selected for design and the characteristics of the specific highway facility.
12. Peak-Hour Factor (PHF). A ratio of the volume occurring during the maximum-volume hour to the maximum rate of flow during a given time period within the peak hour (typically, 15 minutes). PHF may be expressed as follows:

$$\text{PHF} = \frac{\text{Peak Hour Volume}}{4(\text{Peak 15 minute Volume})}$$

13. Service Flow Rate. The maximum hourly rate at which vehicles, bicycles or persons reasonably can be expected to traverse a point or uniform segment of a lane or roadway during a given time period (usually 15 minutes) under prevailing roadway, traffic, environmental and control conditions, while maintaining a designated level of service; expressed as vehicles, bicycles or persons per hour or vehicles per hour per lane.

9.6.2 Design Year Selection

9.6.2.1 Roadway Design

The geometric design of a highway should be developed to accommodate expected traffic volumes during the life of the facility assuming reasonable maintenance. This involves projecting the traffic volumes to a selected future year. Recommended design

years are presented in Figure 9.6A. The design year is measured from the expected construction completion date. Projected traffic volumes on State highways are provided by the Planning Division.

PROJECT SCOPE OF WORK	TYPICAL
New Construction/Reconstruction	20 Years
3R Freeway Projects	Current*
3R Non-Freeway Projects	Current*
Spot Improvements	Current*

* *In general, current traffic volumes may be used. However, if a project will introduce a new geometric design element (e.g., relocation of a horizontal curve), the element should be designed using a 10-year projection and preferably a 20-year projection.*

RECOMMENDED DESIGN YEAR SELECTION

Figure 9.6A

9.6.2.2 Other Highway Elements

The following presents the recommended criteria for selection of a design year for highway elements other than road design:

1. Bridges. The structural life of a bridge may be 75 years or more. For new bridges, bridge replacement and bridge reconstruction, the clear roadway width of the bridge will be based on the 20-year traffic volume projection beyond the construction completion date. In addition, the designer may, on selected projects, evaluate if the bridge design will reasonably accommodate structural expansion to meet the clear roadway width across the bridge based on a traffic volume projection beyond 20 years.
2. Underpasses. The design year used for the geometric design of underpasses will be determined on a case-by-case basis.
3. Right of Way/Grading. The designer may consider potential right of way needs for the anticipated long-term corridor growth for a year considerably beyond that used for roadway design, especially in large metropolitan areas. No specific design year is recommended for use. For example, when selecting an initial median width on a divided highway, the designer may evaluate the potential need for future expansion of the facility to add through travel lanes. Other examples include potential future interchanges, potential reconstruction of a two-

lane, two-way facility to a multilane highway, and the use of flatter side slopes to provide more future options.

4. Drainage Design. Drainage appurtenances are designed to accommodate a flow rate based on a specific design year or frequency of occurrence. The selected design year or frequency will be based on the functional class of the facility, the ADT and the specific drainage appurtenance (e.g., culvert). The structural design life of new drainage appurtenances is typically 50 years.
5. Pavement Design. The pavement structure is designed to withstand the vehicular loads during the design analysis period without falling below a selected pavement serviceability rating. The design life for pavements is typically 20 years.

9.6.3 Design Hourly Volume Selection

9.6.3.1 Selection

For most geometric design elements that are determined by traffic volumes, the peaking characteristics are most significant. The highway facility should be able to accommodate the design hourly volume (adjusted for the peak-hour factor) at the selected level of service. This design hourly volume (DHV) will affect many design elements including the number of through travel lanes, lane and shoulder widths and intersection geometrics. The designer should also analyze the proposed design using the a.m. and p.m. DHVs separately. This could have an impact on the geometric design of the highway.

See the *Highway Capacity Manual* for a detailed discussion on selecting the DHV. Because the design of the project is significantly dependent upon the projected design hourly volumes, carefully examine these projections before using them for design purposes.

9.6.3.2 Factors Affecting DHV Determinations

The following factors will affect the DHV determination:

1. K Factor. The proportion of ADT occurring in the design hour is commonly referred to as the “K” factor. The K factor is expressed as a decimal and is lowest on facilities where fluctuation of peak hour volumes is the least. The highest K values generally occur on recreational routes that have high seasonal, daily and hourly variations. K factors generally range between 0.09 in urban areas and 0.10 in rural areas.

2. Directional Flow. The proportion of DHV traffic traveling in the predominant direction is known as the directional factor (D). This factor reflects the imbalance in directional flow often observed, for example, where traffic is traveling toward employment centers in the a.m. peak and returning home in the p.m. peak. When D is applied to the DHV, it is known as the directional design hour volume (DDHV).
3. Composition. Composition of traffic is normally expressed as the percentage of trucks present in the traffic stream during the design hour. For geometric design and capacity studies, truck traffic is usually converted to passenger car equivalents, because trucks occupy more space and exhibit restrictive operational characteristics. For the purposes of design, light delivery trucks, pickups, etc., operate similarly to passenger cars and are considered to be passenger cars. The *Highway Capacity Manual* presents the passenger car equivalents for large trucks, single-unit trucks with dual rear wheels, buses and recreational vehicles based on the type of facility.

If the K factor, directional distribution and traffic composition are not provided, review the *Highway Capacity Manual* to determine the default values for the facility type being designed. Example 9.6(1) illustrates the procedure for converting ADT to DHV and DDHV.

Example 9.6(1)

Given: Two-lane, rural arterial
ADT = 5,080
K = 14 percent
D = 60 percent

Problem: Determine the DHV and DDHV for the facility.

Solution: The conversion formulas for non-directional ADT to DHV and DDHV are as follows:

$$\text{DHV} = \text{ADT} \times K$$
$$\text{DDHV} = \text{ADT} \times K \times D$$

Therefore,

$$\text{DHV} = 5,080 \times 0.14 = 711 \text{ vehicles per hour}$$
$$\text{DDHV} = 5,080 \times 0.14 \times 0.60 = 427 \text{ vehicles per hour (in the predominant direction)}$$

9.6.4 Capacity Analyses

9.6.4.1 Level of Service

Level of service (LOS) describes a qualitative measure of operational conditions within a traffic stream as perceived by motorists. A designated LOS is described in terms of average travel speed, density, traffic interruptions, comfort, convenience and safety.

Because drivers will accept different driving operational conditions, including lower travel speeds on different facilities, it is not practical to establish one level of service for application to every type of highway. Therefore, several levels have been established for the various classes and types of highways. The values of speed and design hourly volume used in each case to identify a level of service are the lowest acceptable speed and highest obtainable volume for that specific level.

[Chapters 19 through 22](#) present LOS criteria for each highway type.

9.6.4.2 Objective

The highway mainline, intersection or interchange should be designed to accommodate the selected design hourly volume (DHV) at the selected level of service (LOS). This may involve adjusting the various highway factors which affect capacity until a design is determined that will accommodate the DHV. The detailed calculations, factors and methodologies are presented in the *Highway Capacity Manual* (HCM).

The designer should note that, in reality, the service flow rate of the facility is calculated. Capacity assumes a LOS E; the service flow rate is the maximum volume of traffic that a proposed highway of given geometrics is able to serve without the degree of congestion falling below a selected LOS. This is almost always higher than LOS E.

The HCM has established measures of effectiveness (MOE) for the level-of-service definition for each highway element on various types of highway facilities. These are presented in [Figure 9.6B](#). For each MOE, the HCM will provide the analytical tools to calculate the numerical value. The designer should note that highway capacity MOEs may be segregated into two broad categories; (1) uninterrupted flow, or open highway conditions; and (2) interrupted flow, as at stop-controlled or signalized intersections. Uninterrupted flow occurs on highways where the influence of intersections and abutting property development is not significant, and the design volume of a facility can be determined by an hourly rate of flow.

TYPE OF FACILITY	MEASURE OF EFFECTIVENESS
Freeways Basic freeway segments Weaving areas Ramp junctions	Density (passenger cars per mile per lane) Density (passenger cars per mile per lane) Density (passenger cars per hour per lane)
Multilane Highways	Density (passenger cars per mile per lane) Average travel speed (miles per hour) Service flow rate (passenger cars per hour per lane) Maximum volume to capacity ratio (v/c)
Two-Lane, Two-Way Highways	Average travel speed (miles per hour) Percent time-spent-following (percent)
Signalized Intersections	Average controlled delay per vehicle (seconds/vehicle)
Unsignalized Intersections	Average controlled delay per vehicle, for the stopped legs (seconds/vehicle)
Urban Streets	Average travel speed (miles per hour)
Interchanges	Delay (seconds/vehicle)

MEASURES OF EFFECTIVENESS FOR LEVEL OF SERVICE

Figure 9.6B

The following presents the simplified procedure for conducting a capacity analysis for the highway mainline:

1. Select the design year ([Section 9.6.2](#)).
2. Determine the DHV ([Section 9.6.3](#)).
3. Select the level of service (see [Chapters 19 through 22](#)).
4. Document the proposed highway geometric design (lane width, length of weaving section, number and width of approach lanes at intersections, etc.).
5. Using the *Highway Capacity Manual*, analyze the capacity of the highway element for the proposed design.

6. Compare the calculated measured level of service (LOS) with the desired LOS. If the calculated LOS is greater than or equal to the desired LOS, the proposed design will generally meet the objectives of the capacity analysis. If the LOS is lower than the desired LOS, the proposed design may need further evaluation. The designer should either adjust the highway design or should adjust one of the capacity elements (e.g., the selected design year or the level-of-service goal).

The Traffic Engineering Division will perform and review the results of the capacity analyses. Software used for the analyses must be approved by the Department.

9.7 DESIGN VEHICLES

The physical and operational characteristics of vehicles using the highway are important controls in roadway design. Design criteria may vary according to the type of vehicle and the volume of each type of vehicle in the traffic stream.

Vehicular characteristics that impact design include:

1. Size. Vehicular sizes determine lane and shoulder widths, vertical clearances and, indirectly, highway capacity calculations.
2. Offtracking. The design of intersection turning radii, traveled way widening for horizontal curves and pavement widths for interchange ramps are usually controlled by the largest design vehicle likely to use the facility with some frequency.
3. Storage Requirements. Turn bay storage lengths, bus turnouts and parking lot layouts are determined by the number and types of vehicles to be accommodated.
4. Sight Distance. Eye height and braking distances vary for passenger cars and trucks, which can impact sight distance considerations.
5. Acceleration and Deceleration. Acceleration and deceleration rates often govern the dimensioning of such design features as speed-change lanes at intersections and interchange ramps and climbing lanes.
6. Vehicular Stability. Certain vehicles with high centers of gravity may be prone to skidding or overturning, affecting design speed selection and superelevation design elements.

Figures 9.7A and 9.7B present vehicular dimensions and minimum turning radii for typical design vehicles used in South Carolina. Figure 9.7C presents turning characteristics of a typical tractor-semitrailer combination truck. Computer-simulated, turning templates are available for these design vehicles (e.g., AutoTurn).

The selection of appropriate design vehicles for intersections and interchanges is discussed in Chapters 15 and 16, respectively. In general, the designer should select the largest design vehicle that will use the facility with some frequency. However, the designer should consider local restrictions and the occasional larger vehicle that may use the facility. Also note that the twin trailer trucks are restricted to the National Truck Network; see Section 7.3.5.

Design Vehicle Type	Symbol	Dimensions (feet)										Typical Kingpin to Center of Rear Axle
		Overall			Overhang		Wheelbases					
		Height	Width	Length	Front	Rear	WB ₁	WB ₂	S	T	WB ₃	
Passenger car	P	4.25	7	19	3	5	11	–	–	–	–	–
Single unit truck	SU	11-13.5	8.0	30	4	6	20	–	–	–	–	–
City transit bus	CITY-BUS	10.5	8.5	40	7	8	25	–	–	–	–	–
Intercity Bus	BUS-40	12.0	8.5	40	6	6.3	24	3.7	–	–	–	–
	BUS-45	12.0	8.5	45	6	8.5	26.5	4.0	–	–	–	–
Conventional school bus	S-BUS 36	10.5	8.0	35.8	2.5	12	21.3	–	–	–	–	–
Large school bus	S-BUS 40	10.5	8.0	40	7	13	20	–	–	–	–	–
Combination trucks												
Intermediate Semitrailer	WB-40	13.5	8.0	45.5	3	2.5 ^a	12.5	27.5	–	–	–	27.5
Intermediate Semitrailer	WB-50	13.5	8.5	55	3	2 ^a	14.6	35.4	–	–	–	37.5
Interstate Semitrailer*	WB-62*	13.5	8.5	68.5	4	2.5 ^a	21.6	40.4	–	–	–	42.5
Semitrailer - Full Trailer ("Double Bottom")	WB-67D	13.5	8.5	73.3	2.33	3	11.0	23.0	3.0 ^b	7.0 ^b	23.0	23.0
Recreational vehicles												
Motor home	MH	12	8	30	4	6	20	–	–	–	–	–
Car and camper trailer	P/T	10	8	48.7	3	10	11	–	5	19	–	–
Car and boat trailer	P/B	–	8	42	3	8	11	–	5	15	–	–
Motor home and boat trailer	MH/B	12	8	53	4	8	20	–	6	15	–	–
Farm Tractor	TR	10	8-10	16 ^c	–	–	10	9	3	6.5	–	–

* Design vehicle with 48-foot trailer as adopted in 1982 STAA.

- a = Combined dimension of 19.4 feet is typical.
b = Combined dimension of 10.0 feet is typical.
c = To obtain the total length of tractor and one wagon, add 18.5 feet to tractor length.

WB₁, WB₂, WB₃ are effective vehicle wheelbases starting at the front and moving towards the back of the vehicle.

S is the distance from the rear effective axle of a vehicle to the hitch point.

T is the distance from the hitch point of a vehicle measured back to the center of the next axle or center of the tandem axle assembly.

See [Chapter 15](#) for design vehicles used in South Carolina.

TYPICAL DESIGN VEHICLE DIMENSIONS

Figure 9.7A

Design Vehicle Type	Passenger Car	Single Unit Truck	City Transit Bus	Inter-City Bus		Conventional School Bus	Large ⁽³⁾ School Bus	Intermediate Semi-Trailer	Intermediate Semi-Trailer	Inter-State Semi-Trailer	Semi-Trailer/ Full Trailer (Double Bottom)	Motor Home	Passenger Car with Camper	Passenger Car with Boat Trailer	Motor Home and Boat Trailer	Farm ⁽⁴⁾ Tractor with One Wagon
Symbol	P	SU	CITY-BUS	BUS-40	BUS-45	S-BUS 36	S-BUS 40	WB-40	WB-50	WB-62 ⁽¹⁾	WB-67D	MH	P/T	P/B	MH/B	TR/W
Minimum design ⁽²⁾ turning radius (ft)	24	42	42.0	45	45	38.9	39.4	40	45	45	45	40	33	24	50	18
Centerline turning radius (CTR) (ft)	21	38	37.8	40.8	40.8	34.9	35.4	36	41	41	41	36	30	21	46	14
Minimum inside radius (ft)	14.4	28.3	24.5	27.6	25.5	23.8	25.4	19.3	17.0	7.9	19.3	25.9	17.4	8.0	35.1	10.5

(1) Design vehicle with 48-foot trailer as adopted in 1982 STAA.

(2) The turning radius assumed by a designer when investigating possible turning paths and is set at the centerline of the front axle of a vehicle. If the minimum turning path is assumed, the CTR approximately equals the minimum design turning radius minus one-half the front width of the vehicle.

(3) School buses are manufactured from 42 passenger to 84 passenger sizes. This corresponds to wheelbase lengths of 132 inches to 237 inches, respectively. For these different sizes, the minimum design turning radii vary from 28.8 feet to 39.4 feet and the minimum inside radii vary from 14.0 feet to 25.4 feet.

(4) Turning radius is for 150-200 horsepower tractor with one 18.5 feet long wagon attached to hitch point. Front wheel drive is disengaged and without brakes being applied.

(5) See [Figure 9.7C](#) for additional guidance on turning characteristics.

MINIMUM TURNING RADII OF TYPICAL DESIGN VEHICLES

Figure 9.7B

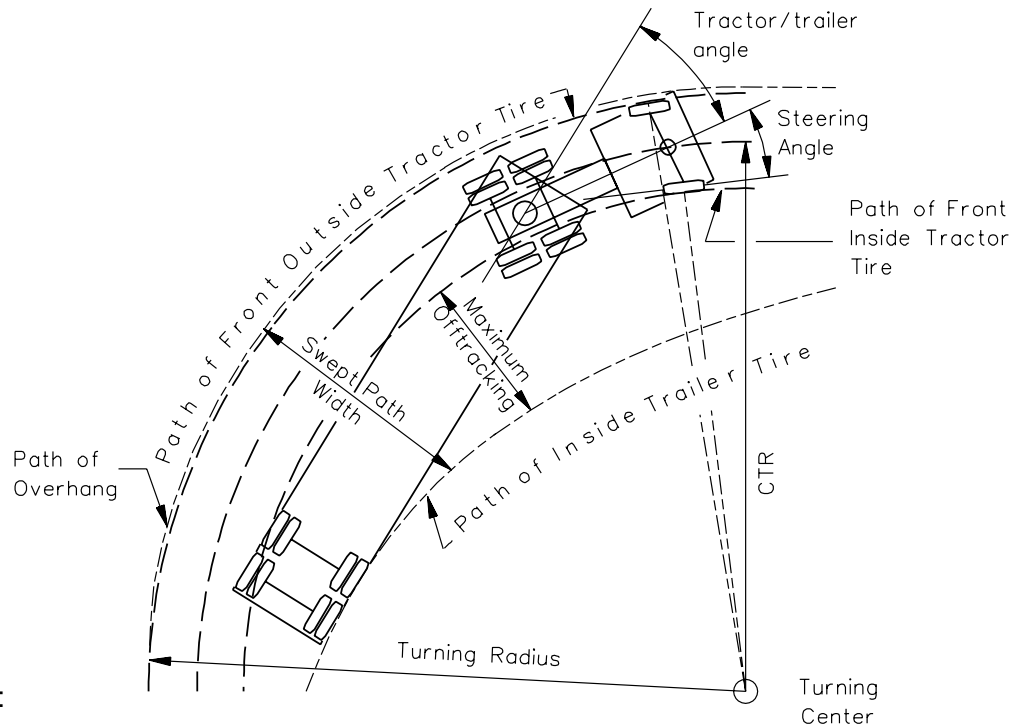

Definitions:

1. **Turning Radius.** The circular arc formed by the turning path radius of the front outside tire of a vehicle. Vehicular manufacturers also describe this radius as the “turning curb radius.”
2. **CTR.** The turning radius assumed by a designer when investigating possible turning paths. It is set at the center of the front axle of a vehicle.
3. **Offtracking.** The difference in the paths of the front and rear wheels of a vehicle as it negotiates a turn. The path of each rearward tire of a turning vehicle does not coincide with that of the corresponding forward tire. This phenomenon is shown in the drawing above.
4. **Swept Path Width.** The amount of roadway width that a vehicle covers in negotiating a turn equal to the amount of offtracking plus the width of the vehicle. The most significant dimension affecting the swept path width of a tractor/semitrailer is the distance from the kingpin to the rear trailer axle or axles. The greater this distance, the greater the swept path width.
5. **Steering Angle.** The maximum angle of turn built into the steering mechanism of the front wheels of a vehicle. This maximum angle controls the minimum turning radius of the vehicle.
6. **Tractor/Trailer Angle.** The angle between adjoining units of a tractor/semitrailer when the combination unit is placed into a turn. This angle is measured between the longitudinal axes of the tractor and trailer as the vehicle turns. The maximum tractor/trailer angle occurs when a vehicle makes a 180° turn at the minimum turning radius and is reached slightly beyond the point where a maximum swept path width is achieved.

TURNING CHARACTERISTICS OF A TYPICAL DESIGN VEHICLE

Figure 9.7C

9.8 ACCESS MANAGEMENT/ACCESS CONTROL

9.8.1 Definitions

The following definitions apply to access management and access control:

1. Access Control. The condition where the public authority regulates the right of abutting owners to have access to and from a public highway by declaring the highway to be either fully or partially access controlled. This is accomplished through the purchase of access rights, driveway controls, turning restrictions or geometric design (e.g., grade separations).
2. Access Management. The process of governing access to land development by a public agency where the agency considers the highway facility and its surrounding activities as part of an overall system. Individual parts of the system (e.g., zoning, land-use planning, site plan development, driveway permits, public transportation, roadway network) should be properly integrated and coordinated. Through proper application of access management, the objectives of providing safe and efficient traffic flow coupled with access to abutting properties can be achieved.
3. Controlled-Access Highway. *South Carolina Code 57-5-1010* states: "Controlled-access facility means a State highway or section of State highway especially designed for through traffic, and over, from or to which highway owners or occupants of abutting property or others shall have only a controlled right or easement of access." The abutting landowner or others have no legal right of access except at points and manners as determined by the Department.
4. Full Control of Access/Limited Access. Highways that are designated to have full control of access are referred to as freeways. Priority is given to through traffic and access to the highway is only provided at interchanges with selected public roads. All other intersecting roads are terminated at the right of way line, perpetuated with grade separations, or interconnected with other roads. Access is provided to properties abutting the freeway via frontage roads, service drives or the existing public road system. Full control of access maximizes the capacity, safety and vehicular speeds on the highway.
5. Partial Control of Access/Limited Access. An expressway design is the common term used for this type of facility. Priority is given to through traffic. Some intersections will be provided and private entrance connections will be allowed by permit. The proper selection and spacing of intersections and other connections provides a balance between the mobility and access functions of the highway.
6. Control by Regulation. All highways warrant some degree of access control by permit or by design. Control by regulation is exercised by the Department, county highway departments or municipalities to specify the location of private

accesses to and from the public road system. Occasionally, statutory control is used to restrict access to only public roads and major traffic generators. Zoning may be used to effectively control development on adjacent property so that major generators do not hinder traffic operations. However, zoning restrictions are at the discretion of the local government. Driveway regulations and permits are used to control the geometric design of an entrance, driveway spacing and driveway proximity to public road intersections.

7. Control Access Line. A line established by the Department that delineates areas where ingress to and egress from a highway facility is prohibited. When an existing access-controlled highway is reconstructed, the access control lines should be reviewed for possible revisions.

9.8.2 Access Management

Access management is a public authority's selective use of regulations, policies and procedures to limit or control public access to and from property abutting highways. It plays an important part in providing a safe and efficient highway system.

Highway transportation involves the movement of persons and goods along highways. A complete system of transportation services must also provide access to abutting properties. There is a trade-off between the mobility and access uses of a highway. In developed areas, arterial highways are particularly susceptible to decisions which conflict with and compromise the principal function of mobility for which the arterial was designed. Generally, the high-capacity, "full-controlled" access highway and the "local access" residential or commercial street, at the other end of the capacity range, present the fewest access management problems and best meet service characteristics noted in the functional classification system.

Traditionally, as a community grows, land subdivides and develops, and businesses are attracted to busy highways. Direct and frequent access is obtained by constructing driveways and intersections. To be effective, address access management in the early stages of land development. As crossroad traffic volumes increase, traffic signals are warranted, and the need to plan for major access points is critical to the mobility function of major highways. Total disregard of access management can create traffic congestion and lead to public demands for better transportation service.

The control and regulation of access to roadways offers the following benefits:

- protects the safety of the motoring public,
- protects the level of service and carrying capacity of the roadway,
- provides reasonable access to development in accordance with needs, and
- delays the need for expensive new projects.

The designer should consider the following objectives of access management:

- limit the number of conflict points,
- separate conflict areas,
- limit the severity of conflicts,
- limit vehicular speed change requirements, and
- maintain the performance of the roadway.

9.8.3 Procedures

The Project Planning Report should identify the type of control proposed for each project. Where it is necessary to revise the control access line, the designer should coordinate with the Right of Way Office.

“Control Access” or “Limited Access” lines should be clearly denoted on the plan drawings; see [Chapter 34](#). Record any breaks in existing access lines on the right of way instrument of record.

9.8.4 Criteria

9.8.4.1 Intersections

Locate all points of access as far from the roadway intersections or railroads as feasible and practical. See SCDOT's *Access and Roadside Management Standards* for additional guidance. In determining the access lines, consider the following:

1. Intersection Radii. Do not locate an access within the radius of the intersecting roadways.
2. Sight Distance. At intersections where the Department has purchased the triangular or sight distance areas, driveways are not permitted to cross or enter the area, except where the elongation of areas may warrant special considerations.
3. Limited Access Facilities. Projects that allow vehicular access to the mainline, via at-grade intersections, are considered “Limited Access.” The control access line will turn away from the mainline facility and follow the side road right of way for a distance of approximately 250 feet; see [Figure 9.8A](#). This distance may be adjusted to accommodate property access along the side road.
4. Median Openings. Wherever applicable, points of access should align directly with existing median openings. Relocate points of access that do not align directly a minimum of 100 feet (edge to edge) from the nearest crossover so that conflicts with traffic using the crossover can be avoided; see [Figure 9.8B](#).

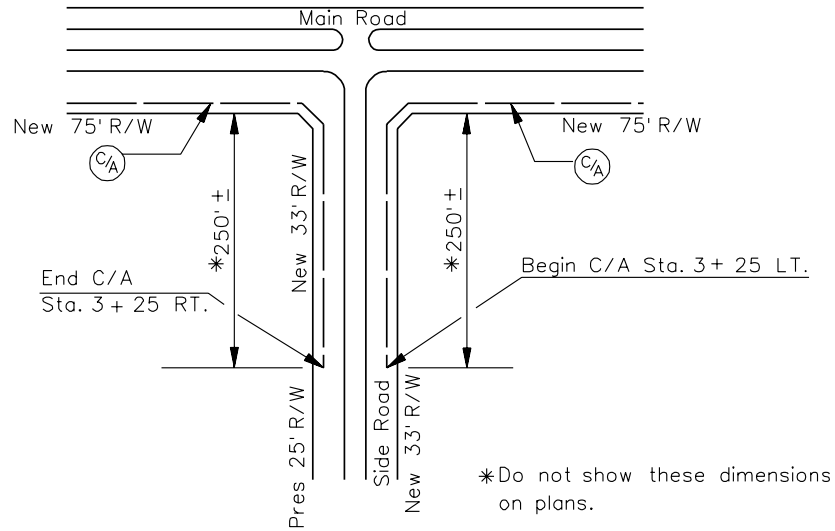

**CONTROL OF ACCESS
(Limited Access Facilities)**

Figure 9.8A

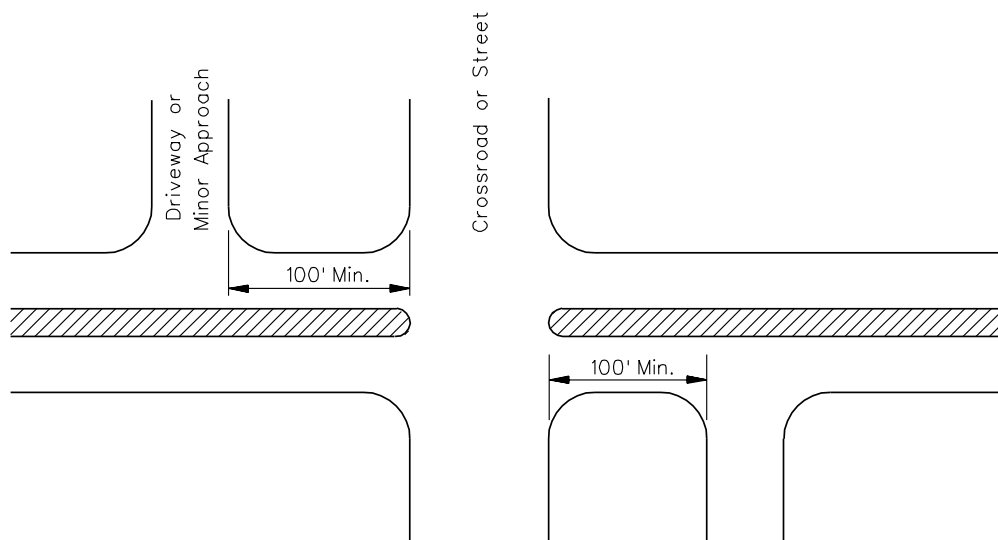

POINTS OF ACCESS WITH MEDIAN CROSSOVERS

Figure 9.8B

9.8.4.2 Interchanges

Proper access control must be provided along the crossing road in the vicinity of the ramp/crossing road intersection or along a frontage road where present. This will insure that the intersection has approximately the same degree of freedom and absence of conflict as the freeway itself. The access control criteria should be consistent with these goals.

Figures 9.8C, 9.8D and 9.8E present access control for several typical interchange designs. These provide SCDOT policy for the location of the limits of control of access lines along the ramp, at ramp/crossroad intersections, across from the ramp terminal and along frontage roads.

As indicated in the figures, the control of access limits extend a distance along the crossing road away from the ramp or frontage road intersection. The 100 feet in urban areas and 300 feet in rural areas should usually satisfy any congestion concerns. However, in areas where the potential for development exists that would create traffic problems, it may be appropriate to consider longer lengths of access control. In addition, many areas have changed over the years from rural to urban. A change in area character alone is not a sufficient justification to alter the location of the control of access line when an existing interchange will be rehabilitated or when SCDOT receives requests for additional access points from outside interests.

These figures note that, on the crossing road, the limit of no access should extend the indicated distance beyond “the ramp terminal.” This is defined as the tangent point (PT) of a radius return or the end of a taper for an auxiliary lane on the crossing road.

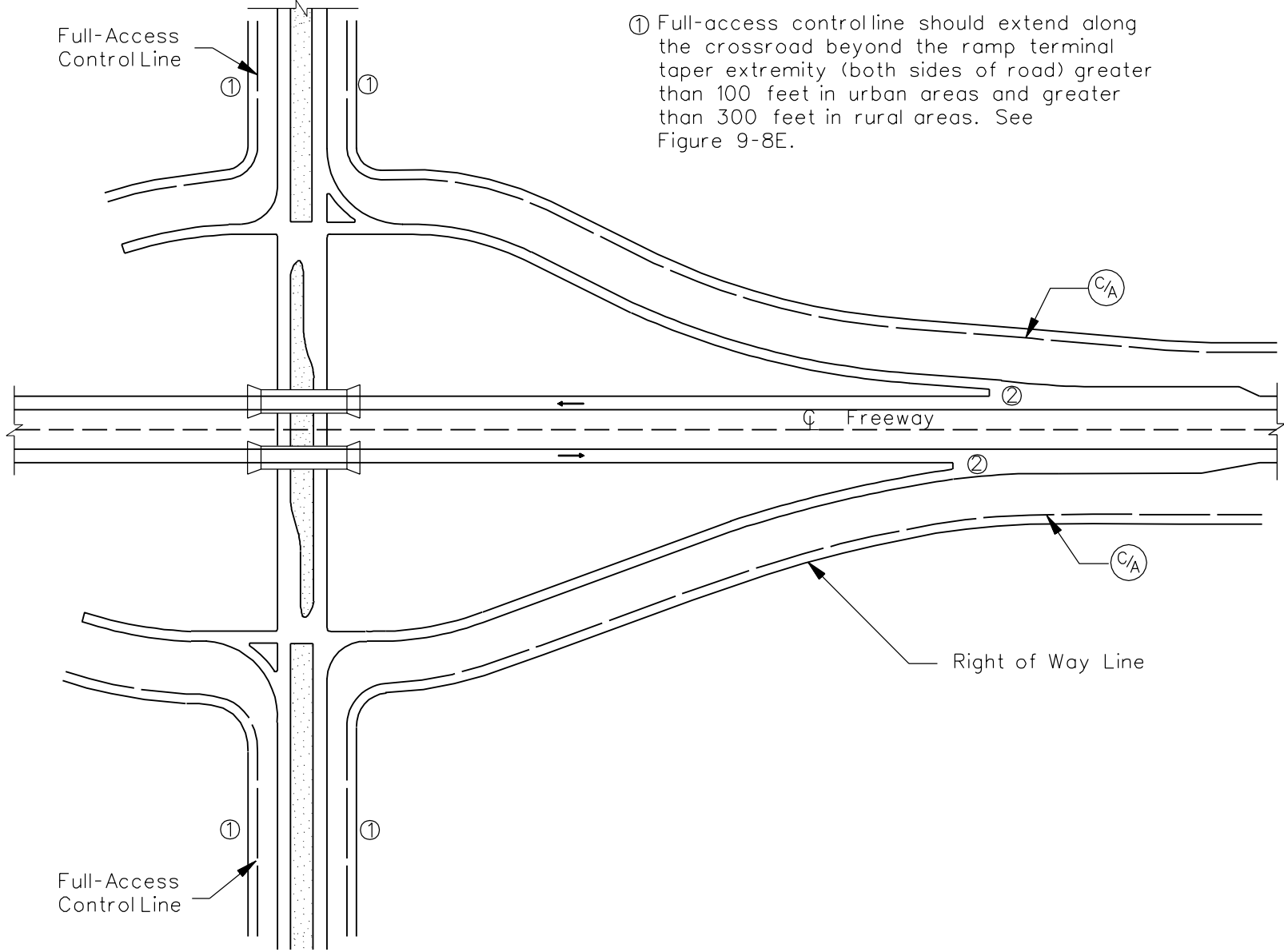

① Full-access control line should extend along the crossroad beyond the ramp terminal taper extremity (both sides of road) greater than 100 feet in urban areas and greater than 300 feet in rural areas. See Figure 9-8E.

TYPICAL ACCESS CONTROL FOR A DIAMOND INTERCHANGE

Figure 9.8C

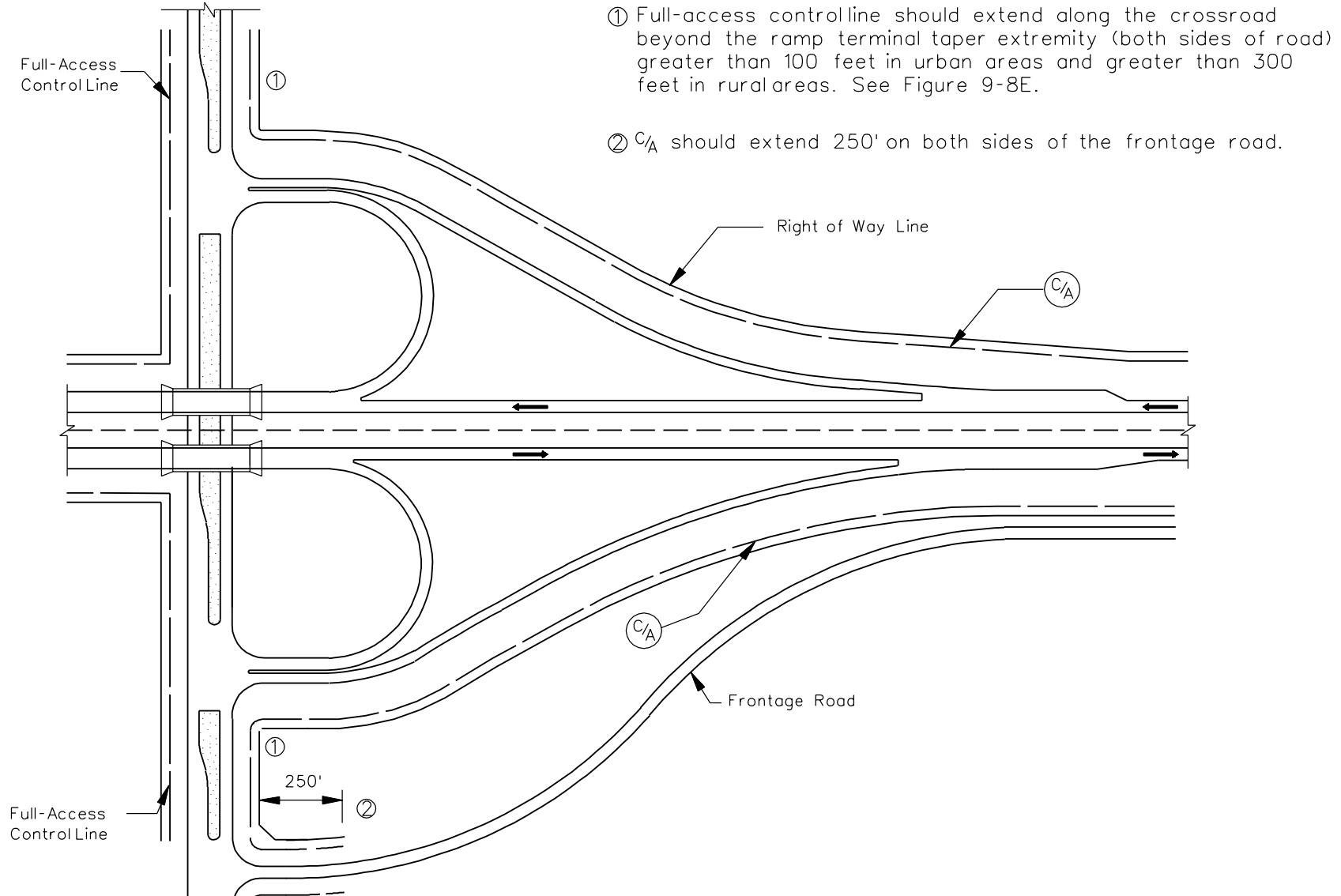

TYPICAL ACCESS CONTROL FOR A PARTIAL CLOVERLEAF INTERCHANGE

Figure 9.8D

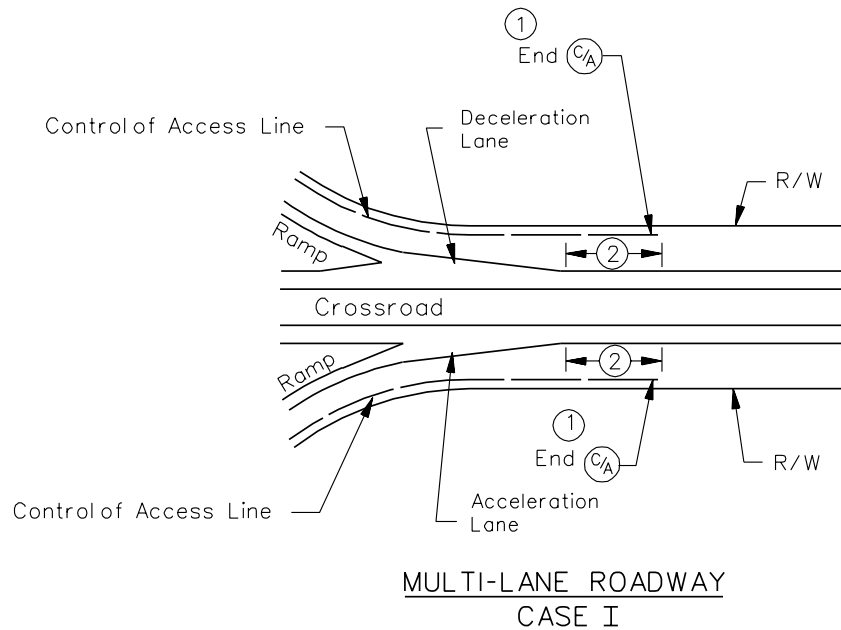

- ① Full-access control line should extend along the crossroad beyond the ramp terminal taper extremity (both sides of road) greater than 100 feet in urban areas and greater than 300 feet in rural areas. The end of access control should be at opposite points, where feasible.
- ② In Case I and II, the auxiliary lane terminating the greater distance from the interchange area should govern.

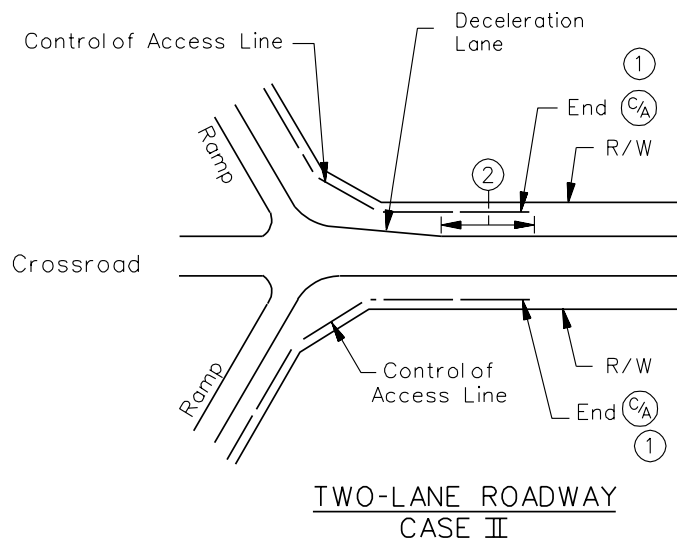

ACCESS CONTROL AT RAMP TERMINALS

Figure 9.8E

9.9 FHWA OVERSIGHT AND INVOLVEMENT

9.9.1 Background

Prior to the passage of the *Intermodal Surface Transportation Efficiency Act* (ISTEA) in 1991, the Federal-aid Highway Program had focused on the construction and improvement of four Federal-aid Systems – Interstate, Primary, Secondary and Urban. ISTEA provided authorizations for highways, highway safety and mass transportation for the next six years. This legislation contained major changes concerning the highway funding program. ISTEA provided for three Federal funding program categories:

- Interstate,
- National Highway System (NHS), and
- Surface Transportation Program (STP).

See [Chapter 7](#) for a discussion on the Federal-aid funding categories.

ISTEA necessitated changes in the working relationship between the Department and FHWA, especially for the type and extent of oversight on Federal-aid projects. *Transportation Equity Act for the 21st Century* (TEA-21), signed in 1998, maintains the Federal funding categories of ISTEA, but this Act precipitated further changes in Federal oversight actions on State highway projects.

9.9.2 Project Oversight

9.9.2.1 Oversight

The following applies:

1. Interstate System. All new construction and reconstruction projects on the Interstate system are to be developed with full FHWA oversight and approval as shown in [Figure 9.9A](#). Upon agreement by the FHWA Division Engineer and the Department, large or complex rehabilitation projects (e.g., 3R freeway projects, maintenance projects) may also be considered for full FHWA oversight.
2. NHS System. For new construction and reconstruction projects on the non-Interstate NHS system, FHWA oversight and approval will be required where the total project costs exceed \$50 million. For 3R projects and new construction and reconstruction projects less than \$50 million, SCDOT will assume all responsibilities in accordance with Section 106 of Title 23 USC.

Project Level Actions	Highway Systems		
	Interstate or NHS > \$50 million	NHS ≤ \$50 million	Non-NHS
All Preliminary Engineering	x		
National Environmental Policy Act (NEPA)	x	x	x
Uniform Relocation Assistance Act and all ROW Matters	x	x	x
Utility Relocation/Railroads	x		
All PS&E Approvals	x	x	
Authority to Advertise for Bid	x		
Approvals of the Award of the Contract	x		
Disadvantaged Business Enterprise (DBE) Program	x	x	x
All Construction Engineering	x		
Davis-Bacon Act Regarding Wages	x	x	x
Approval of Extra Work, Time Extensions and Claims	x		
Approval of Minor Construction Supplemental Agreements and Contract Modifications	x		
Final Acceptance	x		
Interchange Modification and New Access Requests	x		
Utility Crossings and Encroachments	x		
Changes in Right of Way	x		
Highway Beautification	x		
Landscape and Roadside Development	x		
Bridge Type, Size and Location	x		
Geometric Design Approval and Design Exceptions	x		

X = FHWA Involvement Required

Notes:

1. *SCDOT will assume all FHWA responsibilities for design, plans, specifications, estimates, contract awards and inspection of all projects except as shown in the chart.*
2. *Projects not on the NHS will be designed, constructed, operated and maintained according to applicable State laws, regulations, standards and procedures.*
3. *SCDOT can ask FHWA to become involved on any project anytime or for any phase of work of a project. SCDOT can ask for technical assistance on any project issue.*
4. *Any State function is subject to all Title 23 requirements and is subject to FHWA review. FHWA will include a sampling of non-Interstate NHS projects and projects not on the NHS as part of all process reviews and product evaluations.*

FHWA PROJECT OVERSIGHT ACTIONS

Figure 9.9A

3. All other Projects with Federal Funding Participation. SCDOT will assume all responsibilities in accordance with Section 106 of Title 23 USC. This applies to all design activities, PS&E approvals, concurrence in awards and construction and maintenance activities. This precludes the need for any FHWA approval or concurrence, except those actions that require FHWA approval outside of Title 23 USC (e.g., *National Environmental Policy Act* (NEPA), Title VI of the *Civil Rights Act*, *Fair Housing Act* and the *Uniform Relocation Assistance and Land Acquisitions Policies Act*).

9.9.2.2 Laws and Regulations

SCDOT follows all applicable Federal-aid laws and regulations, including the following, plus any other applicable laws and regulations:

- Title 23 USC – *United States Code*, “Highways”;
- 23 CFR – *Code of Federal Regulations*, “Highways”;
- 49 CFR Part 26, “Participation by Disadvantaged Business Enterprises in Department of Transportation Financial Assistance Programs”;
- *The Federal Managers’ Financial Integrity Act of 1982*;
- Title 57 of the *South Carolina Code of Laws*; and
- *Americans with Disabilities Act*.

9.9.2.3 Obligation of Funds

SCDOT requests obligation of funds, and FHWA responds to those requests using FHWA’s electronic Financial Management Information System (FMIS).

SCDOT does not submit requests for obligation of funds on any Federal-aid project until the NEPA approval process has been completed and the projects for which funds are being sought are listed in South Carolina’s Statewide Transportation Improvement Program (STIP).

9.9.2.4 Certification

SCDOT follows all Federal and State laws, regulations and directives for the design, construction, operation and maintenance of all Federal-aid projects.

FHWA is not precluded from reviewing or investigating any phase of the Federal-aid program including control documents on any Federal-aid projects, especially those that

contain unique features or those with unusual circumstances. Furthermore, this does not preclude SCDOT from requesting FHWA involvement in projects. This does not change any of the responsibilities of FHWA regarding the requirements of NEPA, Title VI of the *Civil Rights Acts*, the *Fair Housing Act* and the *Uniform Relocation Assistance and Land Acquisition Policies Act*.

9.10 CONTEXT SENSITIVE DESIGN

9.10.1 Background

During the 1990s, highway design changed rapidly throughout the United States. Highway designers and builders have learned that they must be more sensitive to the impact of highways on the environment and communities. New and better ways of designing highways are evolving following the completion of the Interstate system, based on a growing interest in the improvement of highways and their integration into the communities they serve.

Following the substantial completion of the US Interstate System, the transportation focus for many States has shifted to congestion management and system preservation projects that involve existing facilities. Most of these existing facilities are substantially developed, and transportation improvement projects will affect this development. Working with community stakeholders to preserve and enhance the human and natural environment thus has become a significant component of these projects. To best address the challenges of these projects, many State transportation agencies and professional organizations are interested in implementing a context sensitive design approach for project development.

The *1995 NHS Designation Act* (Section 109 of Title 23, *United States Code*) states:

A design for new construction, reconstruction, resurfacing (except for maintenance resurfacing), restoration, or rehabilitation of a highway on the National Highway System (other than a highway also on the Interstate System) may take into account, in addition to the criteria described in subsection (a):

- *the constructed and natural environment of the area;*
- *the environmental, scenic, aesthetic, historic, community, and preservation impacts of the activity; and*
- *access for other modes of transportation.*

9.10.2 Principles

The following are the basic principles behind context sensitive design:

1. Qualities of Excellence in Transportation Design. The following apply:
 - The project satisfies the purpose and needs as agreed to by a full range of stakeholders. This agreement is forged in the earliest phase of the project and amended as warranted as the project develops.
 - The project is a safe facility for both the user and the community.

- The project is in harmony with the community, and it preserves environmental, scenic, aesthetic, historic and natural resource values of the area (i.e., exhibits context sensitive design).
- The project exceeds the expectations of both designers and stakeholders and achieves a level of excellence in people's minds.
- The project involves the efficient and effective use of the resources (e.g., time, budget, community) of all involved parties.
- The project is designed and built with minimal disruption to the community.
- The project is seen as having added lasting value to the community.

2. Characteristics of the Process Contributing to Excellence. The following apply:

- Communication with all stakeholders is open, honest, early and continuous.
- A multidisciplinary team is established early, with disciplines based on the needs of the specific project, and with the inclusion of the public.
- A full range of stakeholders are involved with transportation officials in the scoping phase. The purposes of the project are clearly defined, and consensus on the scope is forged before proceeding.
- The highway development process is tailored to meet the circumstances. This process should examine multiple alternatives that will result in a consensus of approach methods.
- A commitment to the process from top agency officials and local leaders is secured.
- The public involvement process, which includes informal meetings, is tailored to the project.
- The landscape, the community and valued resources are understood before engineering design is started.
- A full range of tools for communication on project alternatives is used (e.g., visualization).

9.11 DESIGN CONSISTENCY AND DRIVER EXPECTANCY

Design consistency is achieved when the geometric features of the roadway are consistent with the operational characteristics expected by the driver. Inconsistencies normally relate to:

- changes in design speed,
- changes in cross section, and/or
- incompatibility in geometry and operational requirements.

Variations in design speed may occur on a given stretch of roadway when portions of the highway have been constructed as separate projects over an extended period of time. Inconsistencies may include changes in criteria or SCDOT policy, reclassification of the facility or financial feasibility.

The following are two major types of design inconsistencies relative to cross sections:

1. Service Inconsistencies. Service inconsistencies include cross-sectional differences within a given section of highway that are untypical of the area (e.g., one bridge, among many, that does not have full shoulder width; 10-foot wide lanes for a short distance where all other lanes are 12 feet; a short two-lane section on a multilane segment of a highway; a single lane drop on a section of highway that does not have any other lane drops; a left exit on a freeway where all other exits are from the right). Driver expectancies are formed through experience and training. The successful response to situations that generally occur in the same way is an important part of the driver's store of knowledge.
2. Alignment Inconsistency. Cross sectional inconsistencies are usually the result of upgrading a highway cross section without upgrading the alignment. Pavements may be widened and shoulders added on an older two-lane highway. The wider cross section might convey a conflicting message to the driver and lead to an inappropriate expectancy based on the visual aspects of the cross section. Cross section features are more often apparent than the alignment. However, widening alone can measurably improve the safety characteristics of a road, particularly on very narrow, low-volume roads. Designers should be aware of potential inconsistencies that frequently can be overcome with relatively low-cost treatments. Pavement markings, warning signs and delineation devices can be very helpful to the driver when roads are widened on old alignments.

Incompatibility in geometric and operational requirements may result even when geometric components are appropriately selected. An example of this is when a direct entry ramp is designed to permit vehicular entry into the stream of traffic without coming to a complete stop. However, the vehicle is forced to stop when a gap in the through traffic stream is not immediately available.

Driver expectancy relates to the readiness of the driver to respond to events or the presentation of information. It can be defined as an inclination, based on previous experience, to respond in a set manner to a roadway or traffic situation. It should be stressed that the initial response is to the expected situation rather than the actual one.

There are certain elements in the design of various components of the roadway that particularly affect design consistency, driver expectancy and vehicular operation. These components include horizontal and vertical alignment, embankments and cut slopes, shoulders, crown and cross slope, superelevation, bridge widths, signing, delineation and guardrail.

9.12 REFERENCES

1. *A Policy on Geometric Design of Highways and Streets*, AASHTO, 2001.
2. *Highway Capacity Manual 2000*, Transportation Research Board, 2000.
3. *Manual on Uniform Traffic Control Devices: Millennium Edition*, FHWA, ATSSA, AASHTO and ITE, 2001.
4. *Access and Roadside Management Standards*, SCDOT, 1996.
5. *A Policy on Design Standards – Interstate System*, AASHTO, 1991.
6. “Context Sensitive Design/Thinking Beyond the Pavement,” FHWA Website, 2002.
7. “Standards,” Section 109 of Title 23, *United States Code*.
8. *Flexibility in Highway Design*, FHWA Publication No. FHWA-PD-97-062, FHWA, 1997.
9. “Design Exceptions: Legal Aspects,” TRR 1445, Transportation Research Board, 1994.

Table of Contents

<u>Section</u>	<u>Page</u>
10.1 STOPPING SIGHT DISTANCE	10.1(1)
10.1.1 Assumptions.....	10.1(1)
10.1.2 Level Grade.....	10.1(1)
10.1.3 Grade Adjustment	10.1(2)
10.2 PASSING SIGHT DISTANCE.....	10.2(1)
10.2.1 Design.....	10.2(1)
10.2.2 Application.....	10.2(1)
10.3 DECISION SIGHT DISTANCE	10.3(1)
10.3.1 General	10.3(1)
10.3.2 Applications.....	10.3(1)
10.4 INTERSECTION SIGHT DISTANCE.....	10.4(1)
10.4.1 Basic Criteria.....	10.4(1)
10.4.2 Case B – Intersections with Stop Control on the Minor Road	10.4(4)
10.4.2.1 Case B1– Left-Turn From the Minor Road	10.4(4)
10.4.2.2 Case B2 – Right-Turn From the Minor Road.....	10.4(8)
10.4.2.3 Case B3 – Crossing Maneuver From the Minor Road....	10.4(8)
10.4.3 Case D – Intersections with Traffic Signal Control	10.4(10)
10.4.4 Case E – Intersections With All-Way Stop Control.....	10.4(10)
10.4.5 Case F – Left Turns From the Major Road.....	10.4(11)
10.4.6 Effect of Skew	10.4(11)
10.4.7 Examples of ISD Applications	10.4(14)
10.5 REFERENCES.....	10.5(1)

Chapter Ten

SIGHT DISTANCE

Sight distance is the length of the roadway ahead that is visible to the driver. This Chapter discusses stopping, passing, decision and intersection sight distances.

10.1 STOPPING SIGHT DISTANCE

The available sight distance on a roadway should be long enough to enable a vehicle traveling at or near the design speed to stop before reaching a stationary object in its path. Although greater lengths of visible roadway are desirable, the sight distance at every point along a roadway should be at least that needed for a vehicle to stop. Stopping sight distance (SSD) is the sum of the distance traveled during a driver's perception/reaction or brake reaction time and the distance traveled while braking to a stop.

10.1.1 Assumptions

The AASHTO *A Policy on Geometric Design of Highways and Streets* presents the basic equations for determining SSD. The following briefly discusses the basic assumptions within the SSD model:

1. Brake Reaction Time. This is the time interval between when the obstacle in the road can be physically seen and when the driver first applies the brakes. Based on several studies of observed driver reactions, the assumed value is 2.5 seconds. This time is considered adequate for approximately 90 percent of drivers in simple to moderately complex highway environments.
2. Braking Action. The braking action is based on the driver's ability to decelerate the vehicle while staying within the travel lane and maintaining steering control during the braking maneuver. A deceleration rate of 11.2 feet/second/second is considered to be comfortable for 90 percent of the drivers.
3. Speed. Use the highway's design speed to determine the initial driver speed.

10.1.2 Level Grade

Figure 10.1A provides stopping sight distances for passenger cars on grades less than 3 percent. Wherever conditions permit, use values that exceed the required stopping distance for design. When applying the SSD values, the height of eye is assumed to be

3.5 feet and the height of object 2 feet. [Figure 10.1B](#) provides a graphical representation of SSD criteria.

10.1.3 Grade Adjustment

The longitudinal gradient of the roadway impacts the distance needed for vehicles to brake to a stop. [Figure 10.1C](#) presents the grade-adjusted SSD. The designer should make every effort to meet these SSD values where downgrades are 3 percent or greater.

Design Speed (mph)	Brake Reaction Distance (ft)	Braking Distance On Level Grade (ft)	Stopping Sight Distance	
			Calculated (ft)	Design (ft)
15	55.1	21.6	76.7	80
20	73.5	38.4	111.9	115
25	91.9	60.0	151.9	155
30	110.3	86.4	196.7	200
35	128.6	117.6	246.2	250
40	147.0	153.6	300.6	305
45	165.4	194.4	359.8	360
50	183.8	240.0	423.8	425
55	202.1	290.3	492.4	495
60	220.5	345.5	566.0	570
65	238.9	405.5	644.4	645
70	257.3	470.3	727.6	730
75	275.6	539.9	815.5	820
80	294.0	614.3	908.3	910

Note: These SSD values assume a minor road approach grade less than or equal to 3 percent. For grades greater than 3 percent, see [Figure 10.1C](#).

**STOPPING SIGHT DISTANCE
(Level Grade)
Figure 10.1A**

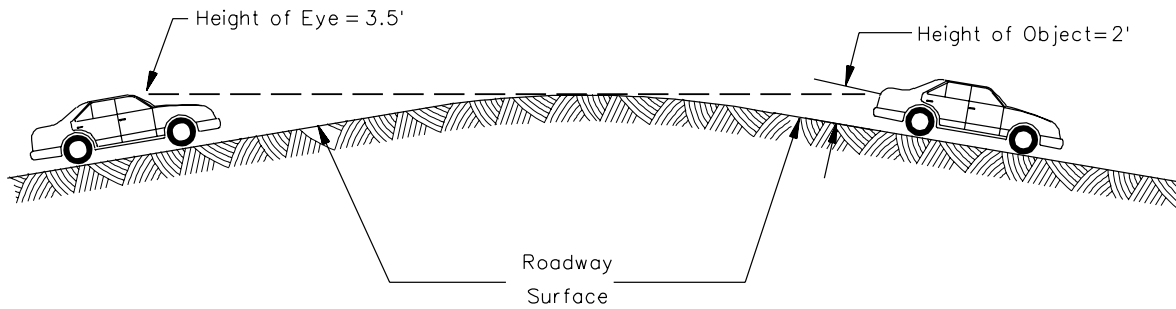

STOPPING SIGHT DISTANCE CRITERIA

Figure 10.1B

SSD FOR DOWNGRADES								
Design Speed (mph)	(3%)	(4%)	(5%)	(6%)	(7%)	(8%)	(9%)	(10%)
15	80	80	80	85	85	85	85	85
20	115	120	120	120	125	125	125	130
25	160	160	165	165	170	170	175	180
30	205	210	215	215	220	225	230	235
35	260	265	270	270	280	285	290	295
40	315	320	330	335	340	350	355	365
45	380	385	395	400	410	420	430	440
50	450	455	465	475	485	495	510	520
55	520	530	545	555	565	580	595	610
60	600	610	625	640	655	670	690	705
65	685	700	715	730	750	765	785	810
70	775	790	810	825	845	870	895	920
75	870	885	905	930	955	980	1005	1035
80	965	990	1010	1035	1065	1095	1125	1155
SSD FOR UPGRADES								
Design Speed (mph)	(3%)	(4%)	(5%)	(6%)	(7%)	(8%)	(9%)	(10%)
15	75	75	75	75	75	75	75	75
20	110	110	110	110	105	105	105	105
25	150	150	145	145	145	145	140	140
30	190	190	190	185	185	180	180	180
35	240	235	235	230	230	225	225	220
40	290	285	280	280	275	275	270	270
45	345	340	335	335	330	325	320	320
50	405	400	395	390	385	380	375	370
55	470	465	460	450	445	440	435	430
60	540	530	525	515	510	505	495	490
65	615	605	595	585	580	570	565	555
70	690	680	670	660	650	640	630	625
75	775	760	750	735	725	715	705	695
80	860	845	830	820	805	795	785	770

Notes:

1. Calculated SSD is not shown. Values in figure have been rounded up to the next highest 5-foot increment.
2. For grades less than 3 percent, no adjustment is necessary (i.e., use the level SSD values in [Figure 10.1A](#)).
3. For grades intermediate between figure values, use a straight-line interpolation to determine the SSD and round up to the next highest 5-foot increment.

GRADE-ADJUSTED STOPPING SIGHT DISTANCE**Figure 10.1C**

10.2 PASSING SIGHT DISTANCE

Passing sight distance considerations are limited to two-lane, two-way highways. On these facilities, vehicles may overtake slower moving vehicles, and the passing maneuver must be accomplished on a lane used by opposing traffic. The minimum passing sight distance for two-lane highways is determined from the sum of four distances as illustrated in [Figure 10.2A](#). For a discussion on how to determine these four distances, the designer should review the AASHTO *A Policy on Geometric Design of Highways and Streets*.

10.2.1 Design

For use in design, passing sight distance should be determined on the basis of the length needed to complete normal passing maneuvers. Normal passing maneuvers are when the passing driver can determine that no potentially conflicting vehicles exist before beginning the maneuver. While there may be occasions to consider passing multiple vehicles, it is not practical to assume these conditions in developing minimum design criteria. Instead, passing sight distance should be determined for a single vehicle passing a single vehicle.

10.2.2 Application

[Figure 10.2B](#) provides the minimum passing sight distance for design on two-lane, two-way highways. These distances allow the passing vehicle to safely complete the entire passing maneuver. These values should not be confused with the values presented in the *MUTCD* for the placement of no-passing zone stripes. In this case, the values are based on different operational assumptions (i.e., distance for the passing vehicle to abort the passing maneuver). The designer should also realize that the highway capacity adjustment in the *Highway Capacity Manual* for two-lane, two-way highways is based on the *MUTCD* criteria for marking no-passing zones. It is not based on the percent of passing sight distance found in the AASHTO *A Policy on Geometric Design of Highways and Streets* as shown in [Figure 10.2C](#).

Passing sight distance is measured from a 3.5-foot height of eye to a 3.5-foot height of object. The 3.5-foot height of object allows the opposing driver to see a sufficient portion of the on-coming vehicle to determine whether to pass.

On rural new construction/reconstruction projects, the designer should attempt to provide passing sight distance over the length of the project consistent with the percentages shown in [Figure 10.2C](#). In determining the percentages, each passing sight distance segment should be greater than 1500 feet. It is generally not cost effective to make significant improvements to the horizontal and vertical alignment solely to increase the available passing sight distance.

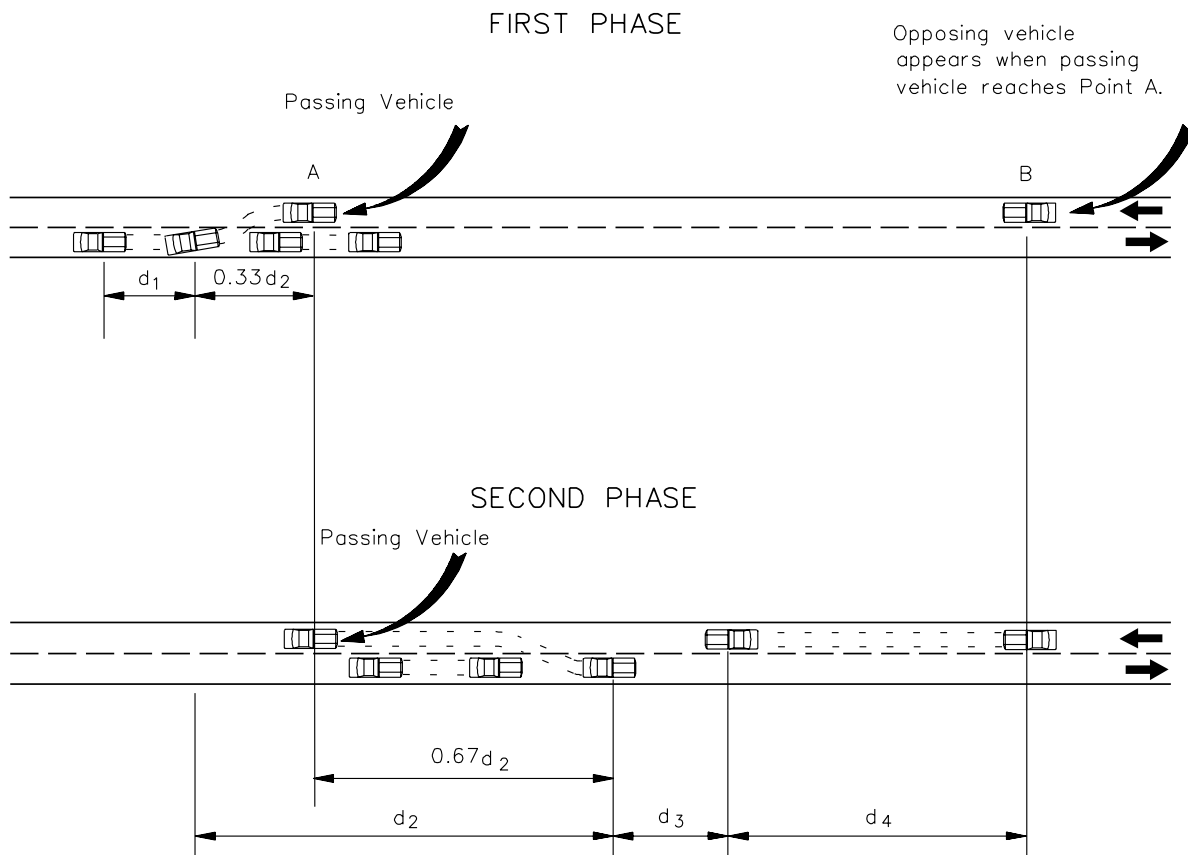

- d_1 = Distance traversed during perception and reaction time and during the initial acceleration to the point of encroachment on the left lane.
- d_2 = Distance traveled while the passing vehicle occupies the left lane.
- d_3 = Distance between the passing vehicle at the end of its maneuver and the opposing vehicle.
- d_4 = Distance traversed by an opposing vehicle for two-thirds of the time the passing vehicle occupies the left lane, or $2/3$ of d_2 above.

Note: To determine d_1 , d_2 , d_3 and d_4 , see the AASHTO A Policy on Geometric Design of Highways and Streets.

ELEMENTS OF PASSING DISTANCE (Two-Lane Highways)

Figure 10.2A

Design Speed (mph)	Passing Sight Distance (ft)	
	Calculated	Rounded for Design
20	706	710
25	897	900
30	1088	1090
35	1279	1280
40	1470	1470
45	1625	1625
50	1832	1835
55	1984	1985
60	2133	2135
65	2281	2285
70	2479	2480
75	2578	2580
80	2677	2680

**PASSING SIGHT DISTANCE
(Two-Lane, Two-Way Highways)**

Figure 10.2B

Terrain	Minimum Percentage Passing Sight Distance		
	Arterials	Collectors	Local
Level	60%	50%	40%
Rolling	40%	30%	20%

**PERCENT OF PASSING SIGHT DISTANCE
(Rural)**

FIGURE 10.2C

10.3 DECISION SIGHT DISTANCE

10.3.1 General

At some sites, drivers may be required to make decisions where the highway environment is difficult to perceive or where unexpected maneuvers are required. These are areas of concentrated demand where the roadway elements, traffic volumes and traffic control devices may all compete for the driver's attention. This relatively complex environment may increase the required driver perception/reaction time beyond that provided by the SSD values (i.e., 2.5 seconds) and, in some locations, the desired vehicular maneuver may be a speed/path/direction change rather than a stop. At these locations, the designer should consider providing decision sight distance to provide an additional margin of safety.

Figure 10.3A provides decision sight distances according to various design speeds. The avoidance maneuvers assumed in the development of Figure 10.3A are:

- Avoidance Maneuver A: Stop on rural road.
- Avoidance Maneuver B: Stop on urban road.
- Avoidance Maneuver C: Speed/path/direction change on rural road.
- Avoidance Maneuver D: Speed/path/direction change on suburban road.
- Avoidance Maneuver E: Speed/path/direction change on urban road.

10.3.2 Applications

In general, the designer should consider using decision sight distance at any relatively complex location where the driver perception/reaction time may exceed 2.5 seconds. Example locations where decision sight distance may be a factor include:

- freeway exit/entrance gores;
- freeway lane drops;
- freeway left-side entrances or exits;
- intersections near a horizontal curve;
- highway/railroad grade crossings;
- approaches to detours and lane closures;
- high-speed, high-volume urban arterials with considerable roadside friction; and/or
- isolated traffic signals on high-speed rural highways.

As with SSD, the driver height of eye is 3.5 feet and the height of object is typically 2.0 feet. However, candidate sites for decision sight distance may also be candidate sites for assuming that the "object" is the pavement surface (e.g., freeway exit gores). Therefore, the designer may assume a 0.0-foot height of object for application at some sites.

Design Speed (mph)	Decision Sight Distance for Avoidance Maneuver (ft)				
	A	B	C	D	E
30	220	490	450	535	620
35	275	590	525	625	720
40	330	690	600	715	825
45	395	800	675	800	930
50	465	910	750	890	1030
55	535	1030	865	980	1135
60	610	1150	990	1125	1280
65	695	1275	1050	1220	1365
70	780	1410	1105	1275	1445
75	875	1545	1180	1365	1545
80	970	1685	1260	1455	1650

Notes:

Avoidance Maneuver A: Stop on rural road.

Avoidance Maneuver B: Stop on urban road.

Avoidance Maneuver C: Speed/path/direction change on rural road.

Avoidance Maneuver D: Speed/path/direction change on suburban road.

Avoidance Maneuver E: Speed/path/direction change on urban road.

DECISION SIGHT DISTANCE

Figure 10.3A

10.4 INTERSECTION SIGHT DISTANCE

For an at-grade intersection to operate properly, adequate sight distance should be available. The designer should provide sufficient sight distance for a driver to perceive potential conflicts and to perform the actions needed to negotiate the intersection safely. The additional costs and impacts of removing sight obstructions are often justified.

In general, intersection sight distance (ISD) refers to the corner sight distance available in intersection quadrants that allows a driver approaching an intersection to observe the actions of vehicles on the crossing leg(s). ISD evaluations involve establishing the needed sight triangle in each quadrant by determining the legs of the triangle on the two intersecting roadways. The necessary clear sight triangle is based on the type of traffic control at the intersection and on the design speeds of the two roadways. The types of traffic control and maneuvers are as follows:

- Case A – Intersections with no control (not used by SCDOT),
- Case B – Intersections with stop control on the minor road:
 - + Case B1 – Left-turn from the minor road,
 - + Case B2 – Right-turn from the minor road,
 - + Case B3 – Crossing maneuver from the minor road,
- Case C – Intersections with yield control on the minor road:
 - + Case C1 – Crossing maneuver from the minor road (not used by SCDOT),
 - + Case C2 – Left or right-turn from the minor road,
- Case D – Intersections with traffic signal control,
- Case E – Intersections with all-way stop control, and
- Case F – Left turns from the major road.

For guidance on these cases, see the AASHTO *A Policy on Geometric Design of Highways and Streets* or NCHRP Report 383, *Intersection Sight Distance*.

10.4.1 Basic Criteria

The Department uses gap acceptance as the conceptual basis for its ISD criteria at stop-controlled and traffic-signal controlled intersections. The intersection sight distance is obtained by providing clear sight triangles both to the right and left as shown in [Figure 10.4A](#). The lengths of legs of these sight triangles are determined as follows:

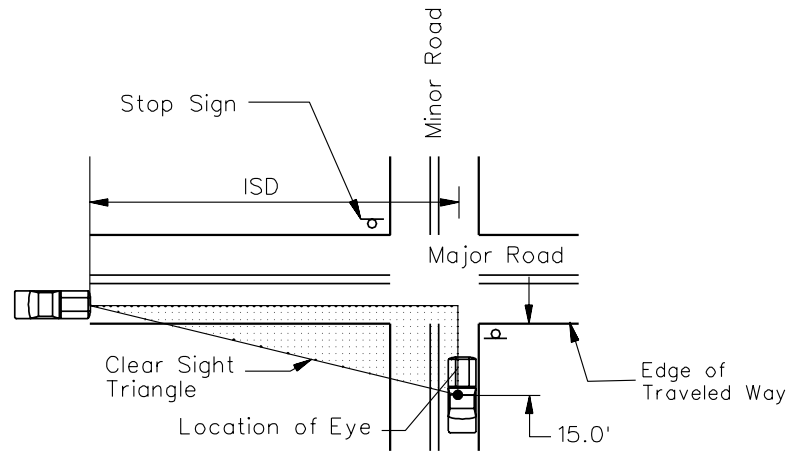

CLEAR SIGHT TRIANGLE FOR VIEWING
TRAFFIC APPROACHING FROM THE LEFT

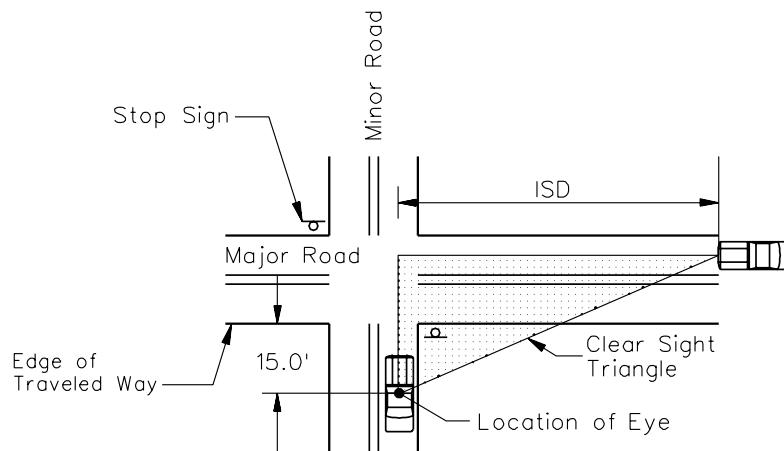

CLEAR SIGHT TRIANGLE FOR VIEWING
TRAFFIC APPROACHING FROM THE RIGHT

Note: The turning radius can change the 15-foot eye location. Adjust this 15-foot dimension using a turning template, if needed.

CLEAR SIGHT TRIANGLES (STOP-CONTROLLED) INTERSECTIONS

Figure 10.4A

1. Minor Road. The length of leg along the minor road is based on two parts. The first is the location of the driver's eye on the minor road. This is typically assumed to be 15 feet from the edge of traveled way for the major road and in the center of the lane on the minor road; see [Figure 10.4A](#). The second part is based on the distance to the center of the vehicle on the major road. For vehicles approaching from the left, this is assumed to be the center of the closest travel lane from the left. For vehicles approaching from the right, this is assumed to be the center of the closest travel lane for vehicles approaching from the right; see [Figure 10.4A](#).
2. Major Road. The length of the sight triangle leg or ISD along the major road is determined using the following equation:

$$ISD = 1.47 V_{\text{major}} t_g \quad (\text{Equation 10.4.1})$$

Where:

ISD	=	length of sight triangle leg along major road (ft)
V_{major}	=	design speed of major road (mph)
t_g	=	gap acceptance time for entering the major road (sec)

The gap acceptance time (t_g) varies according to the design vehicle, the maneuver type, the grade on the minor road approach, the number of lanes on the major roadway, the type of operation and the intersection skew.

3. Height of Eye/Object. The height of eye for passenger cars is assumed to be 3.5 feet above the surface of the minor road. The height of object (approaching vehicle on the major road) is also assumed to be 3.5 feet. An object height of 3.5 feet assumes that a sufficient portion of the oncoming vehicle must be visible to identify it as an object of concern by the minor road driver. If there are a sufficient number of trucks to warrant their consideration, assume an eye height of 7.6 feet for a tractor/semitrailer and 6 feet for single-unit trucks and buses. If a truck is the assumed entering vehicle, the object height will still be 3.5 feet for the passenger car on the major road.

Within this clear sight triangle, if practical, the objective is to remove, lower any object, trim lower tree branches, etc., that obstruct the driver's view. These objects may include buildings, parked or turning vehicles, trees, hedges, tall crops, unmowed grass, fences, retaining walls and the actual ground line. In addition, where a crossroad intersects the major road near a bridge on a crest vertical curve, items such as bridge parapets, piers, abutments, guardrail or the crest vertical curve itself may restrict the clear sight triangle.

10.4.2 Case B – Intersections with Stop Control on the Minor Road

Where traffic on the minor road of an intersection is controlled by stop signs, the driver of the vehicle on the minor road should have sufficient sight distance for a safe departure from the stopped position assuming that the approaching vehicle comes into view as the stopped vehicle begins its departure. At a four-leg intersection, the designer should also check the sight distance across the intersection.

10.4.2.1 Case B1– Left-Turn From the Minor Road

To determine the ISD for vehicles turning left onto the major road, the designer should use [Equation 10.4.1](#) and the gap acceptance times (t_g) presented in [Figure 10.4B](#) for vehicles approaching from the left and right. [Figures 10.4C](#) and [10.4D](#), which solve [Equation 10.4.1](#), provide the ISD values for left-turning design vehicles onto a two-lane level facility and a four-lane with a TWLTL level facility, respectively. The designer should also consider the following:

1. Multilane Facilities. For multilane facilities, the gap acceptance times presented in [Figure 10.4B](#) should be adjusted (i.e., add 0.5 second for passenger cars or 0.7 second for trucks) to account for the additional distance required by the turning vehicle to cross the additional lanes or median.
2. Medians. The following will apply:
 - a. For a multilane facility which does not have a median wide enough to store a design vehicle, divide the median width by 12 feet to determine the lane value (e.g., for a 4-foot median use 0.33), and then use the criteria in [Figure 10.4B](#) to determine the appropriate time factor.
 - b. On facilities with a median wide enough to store the design vehicle (e.g., 3 feet clearance at both ends of vehicle), the designer should evaluate the sight distance needed in two separate steps:
 - First, with the vehicle stopped on the side road (the bottom portion in [Figure 10.4E](#)), use the gap acceptance times and distances for a vehicle turning right ([Figures 10.4B](#) and [10.4C](#)) to determine the applicable ISD. Under some circumstances, it may be necessary to check the crossing maneuver to determine if it is the critical movement. Crossing criteria are discussed in [Section 10.4.2.3](#).
 - Second, with the vehicle stopped in the median (top portion in [Figure 10.4E](#)), assume a two-lane roadway design and use the adjusted gap acceptance times and distances for vehicles turning left ([Figures 10.4B](#) and [10.4C](#)) to determine the applicable ISD.

3. Approach Grades. If the approach grade on the minor road exceeds 3 percent, increase the level ISD value by 10 percent.
4. Design Vehicle. A passenger vehicle is used in most design ISD situations. However, at some intersections (e.g., near truck stops, interchange ramps, schools, grain elevators), the designer should use the design vehicle for determining the ISD. The gap acceptance times (t_g) for passenger cars, single-unit and tractor/semitrailer trucks are provided in [Figure 10.4B](#). ISD values for level, two-lane roadways are presented in [Figure 10.4C](#). The height of eye for these vehicles is discussed in [Section 10.4.1](#).

Design Vehicle	Gap Acceptance Time (t_g) (sec)
Passenger Car	7.5
Single-Unit Truck	9.5
Tractor/Semitrailer	11.5

Adjustments:

1. Multilane Highways. For left turns onto two-way multilane highways, add 0.5 second for passenger cars or 0.7 second for trucks for each additional lane from the left, in excess of one, to be crossed by the turning vehicle. Assume that the left-turning driver will enter the left-travel lane on the far side of the major road.
2. Minor Road Approach Grades. If the approach grade on the minor road exceeds 3 percent, increase the level ISD value by 10 percent.
3. Major Road Approach Grade. Major road grade does not affect calculations.

**GAP ACCEPTANCE TIMES
(Left Turns From Minor Road)**

Figure 10.4B

Design Speed (V_{major}) (mph)	ISD (ft)		
	Passenger Cars	Single-Unit Trucks	Tractor/Semitrailers
15	170	210	255
20	225	280	340
25	280	350	425
30	335	420	510
35	390	490	595
40	445	560	680
45	500	630	765
50	555	700	850
55	610	770	930
60	665	840	1015
65	720	910	1100
70	775	980	1185
75	830	1050	1270
80	885	1115	1350

Note: These ISD values assume a minor road approach grade less than or equal to 3 percent. For grades greater than 3 percent, increase the ISD value by 10 percent.

INTERSECTION SIGHT DISTANCES
(For Vehicles Approaching from the Left and
For Vehicles Approaching from the Right on a Two-Lane Highway or Street Only)

Figure 10.4C

Design Speed (V_{major}) (mph)	ISD (ft)		
	Passenger Cars	Single-Unit Trucks	Tractor/Semitrailers
15	195	245	290
20	255	330	385
25	320	410	485
30	385	490	580
35	445	570	675
40	510	655	770
45	575	735	865
50	635	815	965
55	700	900	1060
60	765	980	1155
65	825	1060	1250
70	890	1140	1350
75	955	1225	1445
80	1015	1305	1540

Notes:

1. *Calculated ISD is not shown. Values in the figure have been rounded up to the next highest 5-foot increment.*
2. *These ISD values assume a minor road approach grade less than or equal to 3 percent. For grades greater than 3 percent, increase the ISD value by 10 percent.*
3. *These ISD values assume the left-turning vehicle will enter the inside travel lane on the far side of the major road.*
4. *For a right turn from a minor road (i.e., ISD to the left), use the ISD values presented in [Figure 10.4C](#).*
5. *Gap acceptance time (t_g) adjustment factors have been used for each additional lane from the left, in excess of one, to be crossed by the turning vehicle (i.e., additional 0.5 second for passenger cars, additional 0.7 second for trucks).*

INTERSECTION SIGHT DISTANCES
(For Vehicles Approaching from the Right on a
Four-Lane Highway with a TWLTL Only)

Figure 10.4D

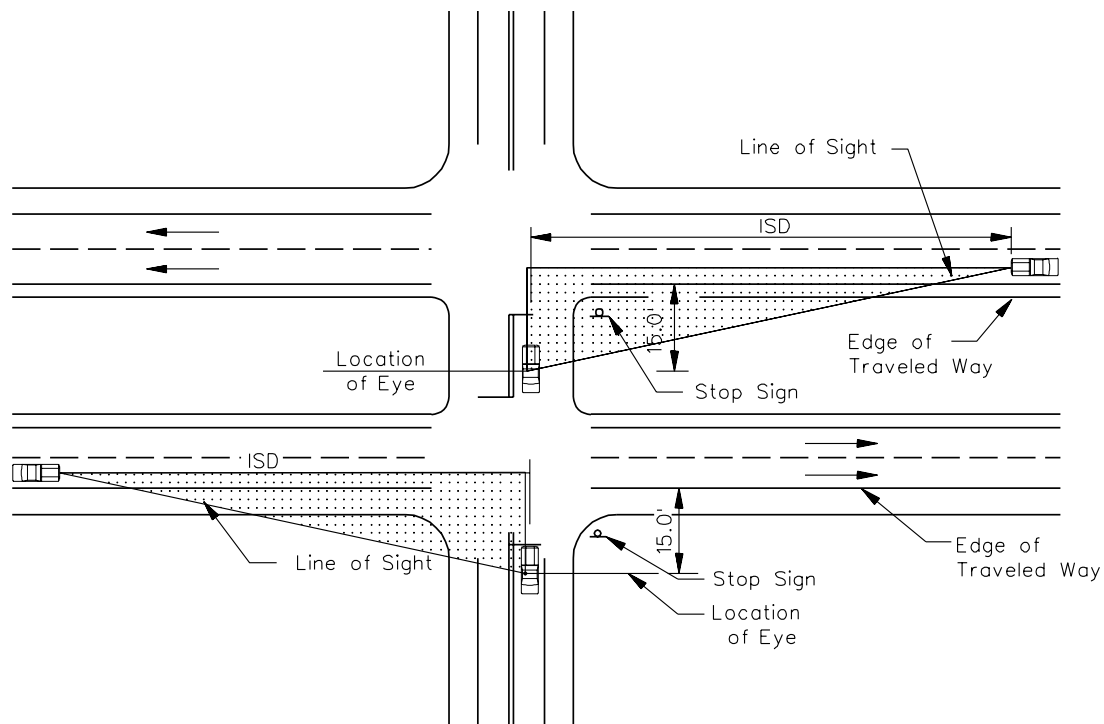

INTERSECTION SIGHT DISTANCE (Divided Facilities)

Figure 10.4E

10.4.2.2 Case B2 – Right-Turn From the Minor Road

ISD for right turns is determined using [Figure 10.4C](#). Note that there are no adjustments required for facilities with medians.

10.4.2.3 Case B3 – Crossing Maneuver From the Minor Road

In the majority of cases, the ISD for turning vehicles typically will provide adequate sight distance to allow a vehicle to cross the major road. However, in the following situations, the crossing sight distance may be the more critical movement:

- where left and/or right turns are not permitted from a specific approach and the crossing maneuver is the only legal or expected movement (e.g., indirect left turns);
- where the design vehicle must cross more than six travel lanes or, with medians, the equivalent distance; or

- where a substantial volume of heavy vehicles cross the highway and there are steep grades on the minor road approach.

Use [Equation 10.4.1](#) and the adjusted gap acceptance times (t_g) in [Figure 10.4F](#) to determine the ISD for crossing maneuvers. [Figure 10.4G](#) presents the applicable ISD values for crossing maneuvers for a level, two-lane highway with no median. Where medians are present, include the median width in the overall length to determine the applicable gap time. Divide this width by 12 feet to determine lane value for the crossing maneuver (e.g., for a 15-foot median use 1.25).

Design Vehicle	Gap Acceptance Time (t_g) (sec)
Passenger Car	6.5
Single-Unit Truck	8.5
Tractor/Semitrailer	10.5

Adjustments:

1. Multilane Highway. Where the design vehicle is crossing a major road with more than two lanes, add 0.5 second for passenger cars or 0.7 second for trucks for each additional lane in excess of two. See the discussion in [Section 10.4.2.3](#) for additional guidance.
2. Approach Grade. If the approach grade on the minor road exceeds 3 percent, increase the ISD value by 10 percent.

**GAP ACCEPTANCE TIMES
(Crossing Maneuvers)**

Figure 10.4F

Design Speed (V_{major}) (mph)	ISD (ft)		
	Passenger Cars	Single-Unit Trucks	Tractor/Semitrailers
15	145	110	235
20	195	250	310
25	240	315	390
30	290	375	465
35	335	440	545
40	385	500	620
45	430	565	695
50	480	625	775
55	530	690	850
60	575	750	930
65	625	815	1005
70	670	875	1080
75	720	940	1160
80	765	1000	1235

Notes:

1. *These ISD values assume turns onto a two-lane facility without a median.*
2. *These ISD values assume a minor road approach grade of 3 percent. For grades greater than 3 percent, increase the ISD value by 10 percent.*

**TWO-LANE INTERSECTION SIGHT DISTANCES
(Crossing Maneuvers)**

Figure 10.4G

10.4.3 Case D – Intersections with Traffic Signal Control

Traffic signals should not be an alternative to providing adequate sight distance. Intersection sight distance as described in [Section 10.4.2](#) should be provided.

10.4.4 Case E – Intersections With All-Way Stop Control

For intersections with all-way stop control, provide sufficient sight distance so that the first stopped vehicle on each approach is visible to all other approaches. The ISD criteria for left- or right-turning vehicles as discussed in [Section 10.4.2](#) are not applicable in this situation. Often, intersections are converted to all-way stop control to address limited sight distance at the intersection.

10.4.5 Case F – Left Turns From the Major Road

For all intersections, regardless of the type of traffic control, the designer should consider the sight distance for a stopped vehicle turning left from the major road. This situation is illustrated in [Figure 10.4H](#). The driver will need to see straight ahead for a sufficient distance to turn left and clear the opposing travel lanes before an approaching vehicle reaches the intersection. Sight distance for opposing left turns may be increased by offsetting the left-turn lanes.

Use [Equation 10.4.1](#) and the gap acceptance times (t_g) from [Figure 10.4I](#) to determine the applicable ISD for the left-turning vehicle. Where the left-turning vehicle must cross more than one opposing lane, add 0.5 second for passenger cars or 0.7 second for trucks for each additional lane in excess of one. Where medians are present and the left-turns are not offset, the designer will need to consider the median width in the same manner as discussed in [Section 10.4.2.1](#). [Figure 10.4J](#) provides the ISD values for typical design vehicles and two common left-turning situations.

10.4.6 Effect of Skew

Where it is impractical to realign an intersection that is greater than 30 degrees from the perpendicular, adjust the gap acceptance times (t_g) presented in the above sections to account for the additional travel time required for a vehicle to make a turn or cross a facility. For oblique-angled intersections, determine the actual path length for a turning or crossing vehicle by dividing the total distance of the lanes and/or median to be crossed by the sine of the intersection angle. If the actual path length exceeds the total width of the lanes to be crossed by 12 feet or more, apply the applicable adjustment factors; see [Figure 10.4K](#).

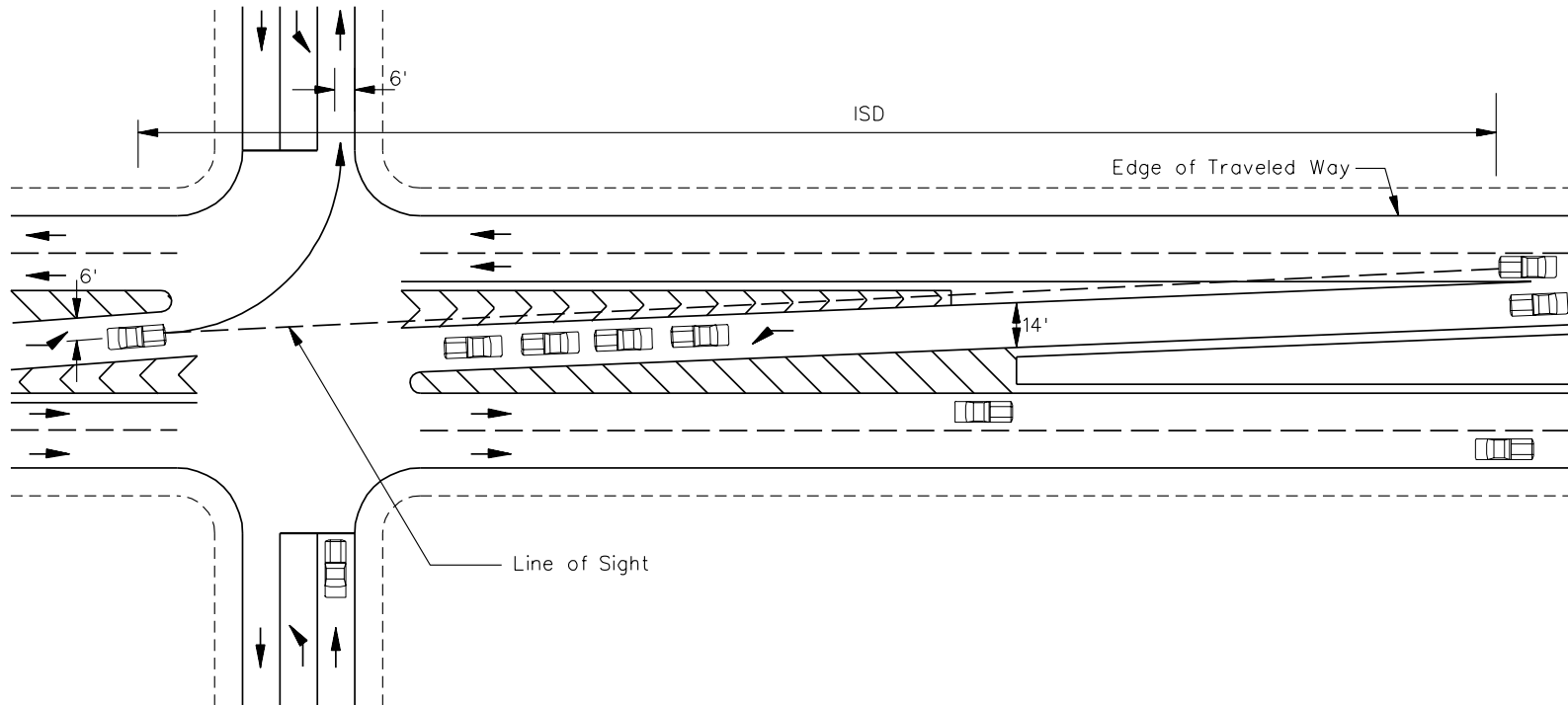

Notes:

1. See [Figure 10.4J](#) for ISD values.
2. See [Section 10.4.5](#) for discussion and application.

**INTERSECTION SIGHT DISTANCE FOR A STOPPED VEHICLE TURNING LEFT
(On Major Road)**

Figure 10.4H

Design Vehicle	Gap Acceptance Time (t_g) (sec)
Passenger Car	5.5
Single-Unit Truck	6.5
Tractor/Semitrailer	7.5

Adjustments: Where left-turning vehicles cross more than one opposing lane, add 0.5 second for passenger cars or 0.7 second for trucks for each additional lane in excess of one. See [Section 10.4.5](#) for additional guidance on median widths.

**GAP ACCEPTANCE TIMES
(Left Turns From Major Road)**

Figure 10.4I

Design Speed (V_{major}) (mph)	ISD (ft)					
	Passenger Cars		Single-Unit Trucks		Tractor/Semitrailers	
	Crossing 1 lane	Crossing 2 lanes	Crossing 1 lane	Crossing 2 lanes	Crossing 1 lane	Crossing 2 lanes
15	125	135	145	160	170	185
20	165	180	195	215	225	245
25	205	225	240	265	280	305
30	245	265	290	320	335	365
35	285	310	335	370	390	425
40	325	355	385	425	445	485
45	365	400	430	480	500	545
50	405	445	480	530	555	605
55	445	490	530	585	610	665
60	485	530	575	640	665	725
65	530	575	625	690	720	785
70	570	620	670	745	775	845
75	610	665	720	795	830	905
80	650	710	765	850	885	965

Note: Assumes no median on major road.

**INTERSECTION SIGHT DISTANCES
(Left Turns From Major Road)**

Figure 10.4J

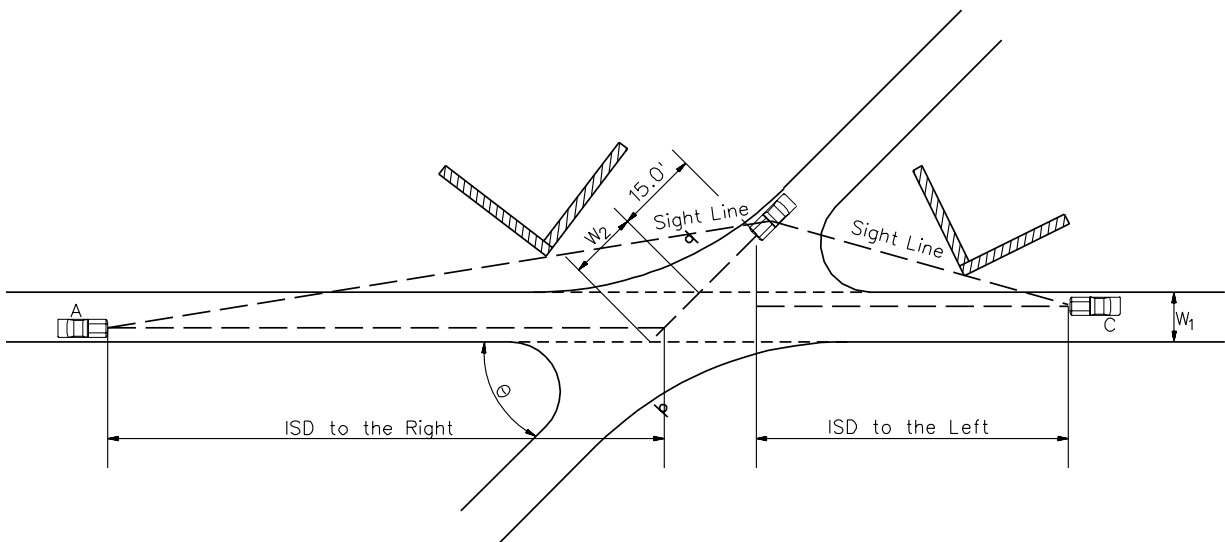

$$W_2 = \frac{W_1}{\sin \theta}$$

Where: W_1 = Major road traveled way width (feet)

W_2 = Adjusted width for skew (feet)

θ = Intersection angle (degrees)

SIGHT DISTANCE AT SKEWED INTERSECTIONS

Figure 10.4K

10.4.7 Examples of ISD Applications

The following three examples illustrate the application of the ISD criteria:

Example 10.4.7(1)

Given: Minor road intersects a four-lane highway with a TWLTL.
 Minor road is stop controlled and intersects major road at 90 degrees.
 Design speed of the major highway is 45 miles per hour.
 All travel lane widths are 12 feet.
 The TWLTL width is 15 feet.
 Grade on minor road is 1 percent.
 Trucks are not a concern.

Problem: Determine the ISD to the left and right from the minor road.

Solution: The following steps will apply:

1. For the passenger car turning right, the ISD to the left can be determined directly from [Figure 10.4C](#). For the 45 miles per hour design speed, the ISD to the left is 500 feet.
2. For the passenger car turning left, the ISD to the right must reflect the additional time required to cross the additional lanes and TWLTL; see [Section 10.4.2.1](#). The following will apply:

- a. First, determine the extra width required by the one additional travel lane and the TWLTL and divide this number by 12 feet:

$$\frac{(12 + 15)}{12} = 2.25 \text{ lanes}$$

- b. Next, multiply the number of lanes by 0.5 second to determine the additional time required:

$$(2.25 \text{ lanes})(0.5 \text{ sec/lane}) = 1.125 \text{ seconds}$$

- c. Add the additional time to the basic gap time of 7.5 seconds and insert this value into Equation 10.4.1:

$$\text{ISD} = (1.47)(45)(7.5 + 1.125) = 575 \text{ feet}$$

Provide an ISD of 575 feet to the right for the left-turning vehicle.

3. Check the crossing vehicle, as discussed in [Section 10.4.2.3](#). The following will apply:

- a. First determine the extra width required by the two additional travel lanes and the TWLTL and divide this number by 12 feet:

$$\frac{(12 + 12 + 15)}{12} = 3.25 \text{ lanes}$$

- b. Next, multiply the number of lanes by 0.5 second to determine the additional time required:

$$(3.25 \text{ lanes})(0.5 \text{ sec/lane}) = 1.625 \text{ seconds}$$

- c. Add the additional time to the basic gap time of 6.5 seconds and insert this value into [Equation 10.4.1](#):

$$\text{ISD} = (1.47)(45)(6.5 + 1.625) = 540 \text{ feet}$$

The 540 feet for the crossing maneuver is less than the 575 feet required for the left-turning vehicle and, therefore, is not the critical maneuver.

Example 10.4.7(2)

Given: Minor road intersects a four-lane divided highway.
 Minor road is stop controlled and intersects major road at 90 degrees.
 Design speed of the major highway is 60 miles per hour.
 All travel lane widths are 12 feet.
 The median width is 50 feet.
 Grade on minor road is 4 percent.
 Grade in median is 1 percent
 The design vehicle is a 64-passenger school bus that is 35.8 feet long.

Problem: Determine the ISD to the left and right from the minor road.

Solution: The following steps apply:

1. For a school bus, assume a SU design vehicle.
2. For the school bus turning right, the ISD to the left can be determined directly from [Figure 10.4C](#). For the 60 miles per hour design speed, the ISD to the left is 840 feet. However, the approach grade is greater than 3 percent; therefore, increase the 840 feet by 10 percent:

$$(840 \text{ feet})(1.10) = 925 \text{ feet}$$

3. Determine if the crossing maneuver is critical; see [Section 10.4.2.3](#). Also, because the approach is greater than 3 percent, the value must be increased by 10 percent. Using [Equation 10.4.1](#) directly and [Figure 10.4F](#):

$$\text{ISD} = (1.47)(60)(8.5)(1.10) = 825 \text{ feet}$$

The crossing maneuver ISD is less than the right-turning maneuver and, therefore, is not critical.

4. For the school bus turning left, it can be assumed the school bus can safely stop in the median (i.e., 50 feet minus 35.8 feet). The ISD to the right can be determined directly from [Figure 10.4C](#). For the 60 miles per hour design speed, the ISD to the right for the left turn is 840 feet. The crossing maneuver will not be critical.

Example 10.4.7(3)

Given: Minor road intersects a four-lane divided highway.
 Minor road is stop controlled and intersects major road at 90 degrees.
 Design speed of the major highway is 50 miles per hour.
 All travel lane widths are 12 feet.
 Existing median width is 24 feet.
 Trucks are not a concern.

Problem: Determine the ISD for a vehicle turning left from the major road.

Solution:

The median is too narrow to store the turning vehicle. Therefore, the turning movement must be made in one motion. For the passenger car turning left, the ISD must reflect the additional time required to cross the median and additional lanes; see [Section 10.4.5](#). The following will apply:

1. First, determine the extra width required by the one additional travel lane and the median and divide this number by 12 feet:

$$\frac{(12 + 24)}{12} = 3 \text{ lanes}$$

2. Next, multiply the number of lanes by 0.5 second to determine the additional time required:

$$(3 \text{ lanes})(0.5 \text{ sec/lane}) = 1.5 \text{ seconds}$$

3. Add the additional time to the basic gap time of 5.5 seconds and insert this value into [Equation 10.4.1](#):

$$\text{ISD} = (1.47)(50)(5.5 + 1.5) = 515 \text{ feet}$$

Provide an ISD of 515 feet for the left-turning vehicle.

10.5 REFERENCES

1. *A Policy on Geometric Design of Highways and Streets*, AASHTO, 2001.
2. NCHRP Report 400, *Determination of Stopping Sight Distances*, Transportation Research Board, 1997.
3. *Highway Capacity Manual 2000*, Transportation Research Board, 2000.
4. NCHRP Report 383, *Intersection Sight Distance*, Transportation Research Board, 1996.

Table of Contents

<u>Section</u>	<u>Page</u>
11.1 DEFINITIONS	11.1(1)
11.2 HORIZONTAL CURVES	11.2(1)
11.2.1 General Theory	11.2(1)
11.2.1.1 Basic Curve Equation.....	11.2(1)
11.2.1.2 Superelevation	11.2(1)
11.2.1.3 Side Friction	11.2(3)
11.2.2 Types of Horizontal Curves	11.2(3)
11.2.2.1 General	11.2(3)
11.2.2.2 Simple Curves.....	11.2(3)
11.2.2.3 Compound Curves	11.2(3)
11.2.2.4 Reverse Curves	11.2(3)
11.2.2.5 Broken-Back Curves	11.2(5)
11.2.3 Minimum Radii	11.2(5)
11.2.4 Maximum Deflection Without Curve	11.2(5)
11.2.5 Minimum Length of Curve	11.2(5)
11.2.6 Traveled Way Widening	11.2(6)
11.2.7 Design Controls.....	11.2(6)
11.3 SUPERELEVATION DEVELOPMENT	11.3(1)
11.3.1 Superelevation Rates	11.3(1)
11.3.1.1 Maximum Superelevation Rate	11.3(1)
11.3.1.2 Superelevation Tables	11.3(1)
11.3.1.3 Minimum Radii Without Superelevation	11.3(1)
11.3.2 Transition Lengths.....	11.3(6)
11.3.2.1 Calculation	11.3(7)
11.3.2.2 Application of Transition Length	11.3(9)
11.3.3 Point of Revolution	11.3(10)
11.3.3.1 Two-Lane, Two-Way Highways	11.3(10)
11.3.3.2 Multilane Highways	11.3(10)

Table of Contents
(Continued)

Section	Page
11.3.4 Shoulder Treatment	11.3(11)
11.3.5 Compound Curves	11.3(11)
11.3.6 Reverse Curves	11.3(12)
11.3.7 Bridges	11.3(14)
11.3.8 Drainage	11.3(14)
11.4 HORIZONTAL SIGHT DISTANCE	11.4(1)
11.4.1 Sight Obstruction (Definition)	11.4(1)
11.4.2 Length > Stopping Sight Distance	11.4(1)
11.4.2.1 Stopping Sight Distance (SSD)	11.4(1)
11.4.2.2 Entering/Exiting Portions (Typical Application).....	11.4(3)
11.4.3 Length < Stopping Sight Distance	11.4(3)
11.4.4 Application.....	11.4(4)
11.5 REFERENCES.....	11.5(1)

Chapter Eleven

HORIZONTAL ALIGNMENT

This Chapter presents SCDOT criteria for the design of horizontal alignment elements. This includes horizontal curvature, superelevation and sight distance around horizontal curves.

11.1 DEFINITIONS

The following presents definitions for basic elements of horizontal alignment:

1. Broken-Back Curves. Closely spaced horizontal curves with deflection angles in the same direction with an intervening, short tangent section (less than 1500 feet).
2. Compound Curves. A series of two or more simple curves with deflections in the same direction immediately adjacent to each other without a tangent section.
3. Maximum Side Friction (f_{max}). Limiting values selected by AASHTO for use in the design of horizontal curves. The designated f_{max} values represent a threshold of driver discomfort and not the point of impending skid.
4. Maximum Superelevation (e_{max}). An overall superelevation control used on a widespread basis. Its selection depends on several factors including type of area (rural or urban), design speed and climate.
5. Normal Crown (NC). The typical cross slope on a tangent section of roadway (i.e., no superelevation).
6. Point of Revolution. The point about which the pavement is revolved to superelevate the roadway.
7. Relative Longitudinal Gradient (G_R). For superelevation transition sections on two-lane facilities, the relative gradient between the centerline profile grade and edge of traveled way grade.
8. Remove Adverse Crown (RC). A superelevated roadway section that is sloped across the entire traveled way in the same direction and at a rate equal to the cross slope on the tangent section (typically, 2.08 percent).
9. Reverse Curves. Two simple curves with deflections in opposite directions which are joined by a relatively short tangent distance or which have no intervening tangent (i.e., the PT and PC are at the same point).

10. Side Friction (f). The interaction between the tire and the pavement surface to counterbalance, in combination with the superelevation, the centrifugal force or lateral acceleration of a vehicle traversing a horizontal curve.
11. Simple Curves. Continuous arcs of constant radius which achieve the necessary highway deflection without an entering or exiting transition.
12. Superelevation (e). The amount of cross slope or “bank” provided on a horizontal curve to counterbalance, in combination with the side friction, the centrifugal force of a vehicle traversing the curve.
13. Superelevation Transition Length. The distance required to transition the roadway from a normal crown section to the design superelevation rate. Superelevation transition length is the sum of the tangent runout (TR) and superelevation runoff (L) distances:
 - a. Tangent Runout (TR). The distance needed to change from a normal crown section to a point where the adverse cross slope of the outside lane or lanes is removed (i.e., the cross slope of the outside lane(s) is level).
 - b. Superelevation Runoff (L). The distance needed to change the cross slope from the end of the tangent runout (adverse cross slope is removed) to a section that is sloped at the design superelevation rate (e).

11.2 HORIZONTAL CURVES

Horizontal curves are, in effect, transitions between two tangents. These deflectional changes are necessary in virtually all highway alignments to avoid impacts on a variety of field conditions (e.g., right of way, natural features, man-made features). [Figure 11.2A](#) illustrates a simple horizontal curve.

11.2.1 General Theory

This Section briefly summarizes the theoretical basis for the design of horizontal curves. For more information, the designer should review the latest edition of *AASHTO A Policy on Geometric Design of Highways and Streets*.

11.2.1.1 Basic Curve Equation

The point-mass formula is used to define vehicular operation around a curve. Where the curve is expressed using its radius, the basic equation for a simple curve is:

$$R = \frac{V^2}{15(e + f)} \quad (\text{Equation 11.2.1})$$

Where:

- R = radius of curve, feet
- e = superelevation rate, decimal
- f = side-friction factor, decimal
- V = vehicular speed, miles per hour

To convert to the degree-of-curve definition for a horizontal curve, use the following equation:

$$D = 5729.578/R \quad (\text{Equation 11.2.2})$$

Where:

- D = degree of curve, degrees
- R = radius of curve, feet

11.2.1.2 Superelevation

Superelevation allows a driver to negotiate a curve at a higher speed than would otherwise be comfortable. Superelevation and side friction work together to offset the outward pull of the vehicle as it traverses the horizontal curve. In highway design, it is necessary to establish limiting values of superelevation (e_{\max}) based on the operational characteristics of the facility. See [Section 11.3.1](#).

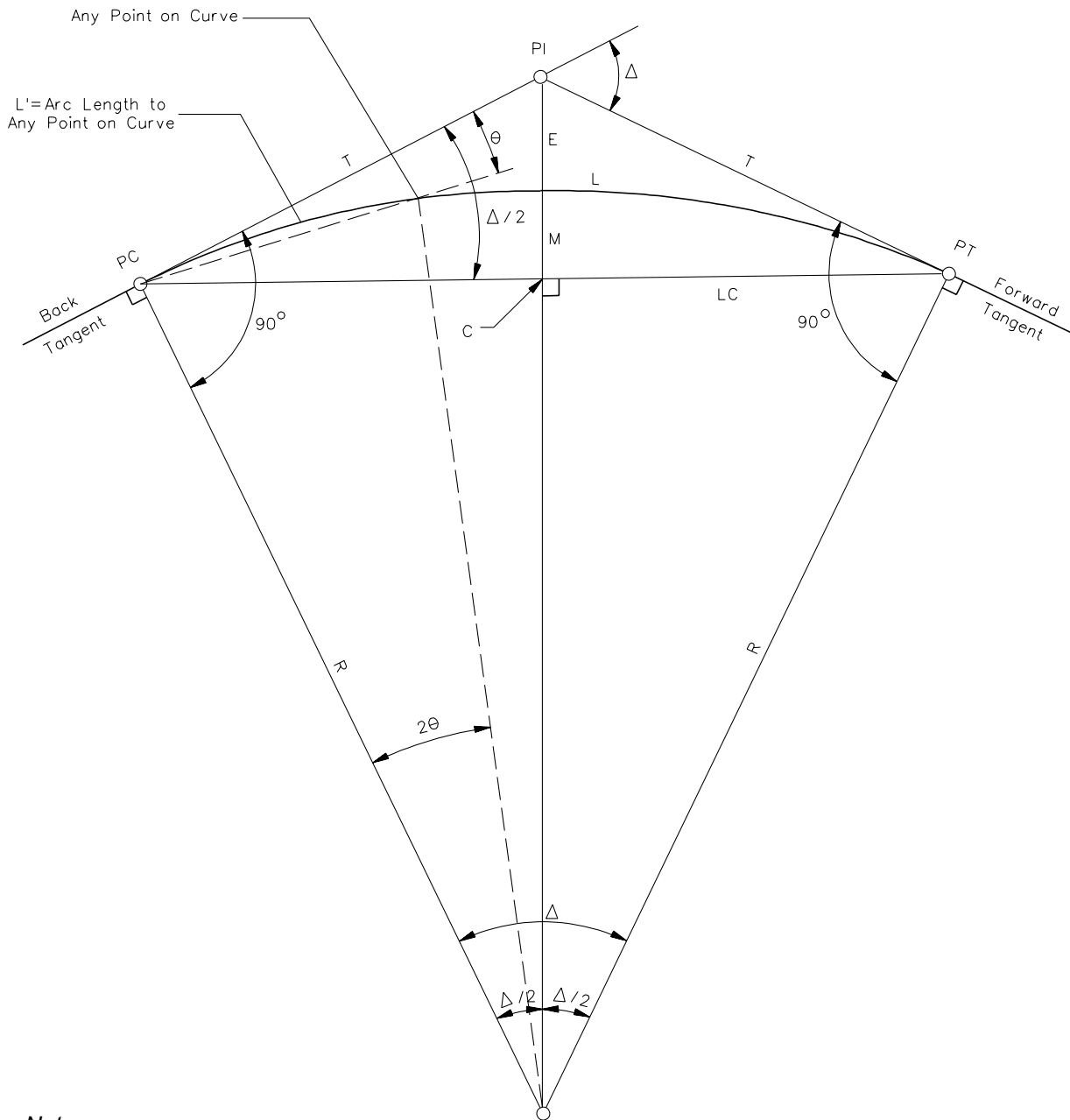

Notes:

- PI = Point of Intersection of Tangents*
- PC = Point of Curvature (Beginning of Curve)*
- PT = Point of Tangency (End of Curve)*
- R = Radius of Curve, feet*
- C = Mid-point of Long Chord*
- Δ = Deflection Angle Between Tangents or Central Angle, degrees*
- T = Tangent, Distance, feet*
- LC = Length of Long Chord, feet*
- L = Length of Curve, feet*
- E = External Distance, feet*
- M = Middle Ordinate*

$$E = T \tan\left(\frac{\Delta}{4}\right)$$

$$T = R \tan\left(\frac{\Delta}{2}\right) \text{ where } \Delta \text{ is expressed as a decimal}$$

$$LC = 2T \left(\cos\left(\frac{\Delta}{2}\right) \right)$$

$$M = R \left(1 - \cos\left(\frac{\Delta}{2}\right) \right)$$

$$L = \frac{\Delta R}{57.2958}$$

SIMPLE HORIZONTAL CURVE ELEMENTS

Figure 11.2A

11.2.1.3 Side Friction

AASHTO has established limiting side-friction factors (f) for various designs. It is important to understand that the f values used in design represent a threshold of driver discomfort and not the point of impending skid. See [Figures 11.2B](#) through [11.2D](#) for maximum f values.

11.2.2 Types of Horizontal Curves

11.2.2.1 General

This Section discusses the types of horizontal curves that may be used to achieve the necessary roadway deflection. For each type, the discussion briefly describes the curve and presents the SCDOT usage of the curve type.

11.2.2.2 Simple Curves

Simple curves are continuous arcs of constant radius that achieve the necessary roadway deflection without an entering or exiting transition. The radius (R) defines the circular arc that a simple curve will transcribe. All angles and distances for simple curves are computed in a horizontal plane; see [Figure 11.2A](#).

Because of their simplicity and ease of design, survey and construction, SCDOT typically uses the simple curve on its highways. See the *Road Design Plan Preparation Guide* for more details on the design and layout of simple curves.

11.2.2.3 Compound Curves

Compound curves are a series of two or more simple curves of different radii with deflections in the same direction. SCDOT uses compound curves on a highway mainline only to maintain a desired alignment or to meet field conditions (e.g., to avoid obstructions which cannot be relocated) where a simple curve is not applicable. When a compound curve is used on a highway mainline, the radius of the flatter circular arc (R_1) should not be more than 50 percent greater than the radius of the sharper circular arc (R_2). In other words, $R_1 \leq 1.5 R_2$. These design guidelines for compound curves are developed on the premise that travel is in the direction of sharper curvature. For the acceleration condition, the 2:1 ratio is not as critical and may be exceeded.

[Chapter 15](#) discusses the use of compound curves for intersections (e.g., for curb radii, for turning roadways). [Chapter 16](#) discusses the use of compound curves on interchange ramps.

Design Speed, (V) (miles per hour)	f_{\max}	Minimum Radii, R_{\min}^* (feet)
55	0.130	965
60	0.120	1205
65	0.110	1485
70	0.100	1820

MINIMUM RADII
($e_{\max} = 8.0$ Percent)

Figure 11.2B

Design Speed, (V) (miles per hour)	f_{\max}	Minimum Radii, R_{\min}^* (feet)
20	0.170	115
25	0.165	185
30	0.160	275
35	0.155	380
40	0.150	510
45	0.145	660
50	0.140	835

MINIMUM RADII
($e_{\max} = 6.0$ Percent)

Figure 11.2C

Design Speed, (V) (miles per hour)	f_{\max}	Minimum Radii, R_{\min}^* (feet)
20	0.170	130
25	0.165	205
30	0.160	305
35	0.155	425
40	0.150	565
45	0.145	735

MINIMUM RADII
($e_{\max} = 4.0$ Percent)

Figure 11.2D

$$*R_{\min} = \frac{V^2}{15(e_{\max} + f_{\max})}$$

11.2.2.4 Reverse Curves

Reverse curves are two simple curves with deflections in opposite directions that are joined by a relatively short tangent distance. In rural areas, 500 feet should desirably be provided between the PT and PC of the two curves for appearance. Superelevation development for reverse curves requires special attention. This is discussed in [Section 11.3](#).

11.2.2.5 Broken-Back Curves

Broken-back curves are closely spaced horizontal curves with deflection angles in the same direction with an intervening, short tangent section (less than 1500 feet) from PT to PC. Desirably, the use of broken-back curves should be limited on the highway mainline because of the potential for confusing a driver, problems with superelevation development and the unpleasant view of the roadway that is created.

11.2.3 Minimum Radii

The minimum radii is calculated from [Equation 11.2.1](#) using the applicable values of e_{\max} and f_{\max} . See [Figures 11.2B, 11.2C and 11.2D](#). In most cases, the designer should limit the use of minimum radii because this results in the use of maximum superelevation rates.

11.2.4 Maximum Deflection Without Curve

It may be appropriate to omit a horizontal curve where very small deflection angles are present. As a guide, the designer may retain deflection angles of approximately 1 degree or less (urban) and 0 degree 30 minutes or less (rural) on the highway mainline. For these angles, the absence of a horizontal curve should not affect aesthetics.

11.2.5 Minimum Length of Curve

For small deflection angles, horizontal curves should be sufficiently long to avoid the appearance of a kink. For aesthetics, a minimum 500-foot length of curve for a 5-degree central angle will eliminate the sense of abruptness. Where the central angle is less than 5 degrees, see [Figure 11.2E](#) for the minimum length of curve.

Deflection Angle	Minimum Length (Feet)
5°00'	500
4°30'	550
4°00'	600
3°30'	650
3°00'	700
2°30'	750
2°00'	800

MINIMUM LENGTHS OF CURVE

Figure 11.2E

11.2.6 Traveled Way Widening

Traveled way widening may be considered on the inside edge of horizontal curves on two-lane highways for the following reasons:

1. Vehicles (especially trucks) occupy a greater effective width because rear wheels track inside of front wheels when rounding a curve.
2. Known problem areas (e.g., where the inside shoulder has broken up) may warrant widening.

Figure 11.2F presents design values to be used for traveled way widening on horizontal curves.

Widening should be applied to the inside edge of pavement only. The transition distance for traveled way widening should equal the superelevation transition length, and it should be applied with the superelevation transition. See the *SCDOT Standard Drawings* for details.

11.2.7 Design Controls

As discussed in Chapter 11, the design of horizontal alignment involves, to a large extent, complying with specific limiting criteria. These include minimum radii, superelevation rates and sight distance around curves. In addition, the designer should adhere to certain design principles and controls that will determine the overall safety of the facility and will enhance the aesthetic appearance of the highway. These design principles include:

Radius of curve (feet)	Traveled Way Width = 24 feet							Traveled Way Width = 22 feet							Traveled Way Width = 20 feet						
	Design Speed (miles per hour)							Design Speed (miles per hour)							Design Speed (miles per hour)						
	30	35	40	45	50	55	60	30	35	40	45	50	55	60	30	35	40	45	50	55	60
7000																				2.0	2.0
6500																				2.0	2.1
6000																			2.0	2.1	2.1
5500																		2.0	2.0	2.1	2.2
5000																	2.0	2.0	2.1	2.2	2.2
4500																	2.0	2.1	2.2	2.2	2.3
4000															2.0	2.1	2.2	2.3	2.4	2.4	2.5
3500															2.1	2.2	2.3	2.4	2.5	2.5	2.6
3000															2.2	2.3	2.4	2.5	2.6	2.7	2.8
2500													2.0	2.1	2.5	2.6	2.7	2.8	2.9	3.0	3.1
2000											2.0	2.1	2.3	2.4	2.7	2.8	2.9	3.0	3.1	3.3	3.4
1800									2.0	2.2	2.3	2.4	2.5	2.6	2.9	3.0	3.2	3.3	3.4	3.5	3.6
1600								2.1	2.2	2.3	2.4	2.6	2.7	2.8	3.1	3.2	3.3	3.4	3.6	3.7	3.8
1400						2.0	2.1	2.3	2.5	2.6	2.7	2.9	3.0	3.1	3.3	3.5	3.6	3.7	3.9	4.0	4.1
1200				2.0	2.2	2.3	2.4	2.6	2.7	2.9	3.0	3.2	3.3	3.4	3.6	3.7	3.9	4.0	4.2	4.3	4.4
1000	2.0	2.2	2.3	2.5	2.6	2.8	3.0	3.0	3.2	3.3	3.5	3.6	3.8	4.0	4.0	4.2	4.3	4.5	4.6	4.8	5.0
900	2.3	2.5	2.7	2.8	3.0	3.2		3.3	3.5	3.7	3.8	4.0	4.2		4.3	4.5	4.7	4.8	5.0	5.2	
800	2.7	2.9	3.0	3.2	3.4	3.6		3.7	3.9	4.0	4.2	4.4	4.6		4.7	4.9	5.0	5.2	5.4	5.6	
700	3.1	3.3	3.5	3.7	3.9			4.1	4.3	4.5	4.7	4.9			5.1	5.3	5.5	5.7	5.9		
600	3.8	4.0	4.2	4.4	4.6			4.8	5.0	5.2	5.4	5.6			5.8	6.0	6.2	6.4	6.6		
500	4.6	4.8	5.0	5.2				5.6	5.8	6.0	6.2				6.6	6.8	7.0	7.2			
450	5.1	5.3	5.5					6.1	6.3	6.5					7.1	7.3	7.5				
400	5.8	6.0	6.3					6.8	7.0	7.3					7.8	8.0	8.3				
350	6.7	7.0	7.2					7.7	8.0	8.2					8.7	9.0	9.2				
300	7.8	8.1						8.8	9.1						9.8	10.1					
250	9.4							10.4							11.4						
200	11.8							12.8							13.8						

Note: Values shown are for WB-62 design vehicle and represent widening in feet.

**VALUES FOR TRAVELED WAY WIDENING ON INSIDE OF HORIZONTAL CURVES
(Two-Lane Highways, One-Way or Two-Way)**

Figure 11.2F

1. Consistency. Alignment should be consistent. Sharp curves at the ends of long tangents and sudden changes from gentle to sharply curving alignment should be avoided.
2. Directional. Alignment should be as directional as practical and consistent with physical and economic constraints. On divided highways a flowing line that conforms generally to the natural contours is preferable to one with long tangents that slash through the terrain. Directional alignment will be achieved by using the smallest practical central angles.
3. Use of Minimum Radii. The use of minimum radii should be avoided if practical, especially in level terrain.
4. High Fills. Avoid sharp curves on long, high fills. Under these conditions, it is difficult for drivers to perceive the extent of horizontal curvature.
5. Alignment Reversals. Avoid abrupt reversals in alignment (reverse curves). Provide a sufficient tangent distance between the curves to insure proper superelevation transitions for both curves and to allow time for the motorist to perceive the next decision point.
6. Broken-Back Curvature. This arrangement is not aesthetically pleasing. It may violate driver expectancy and may create undesirable superelevation development requirements. They should be avoided when possible.
7. Compound Curves. Limit the use of compound curves on highway mainline.
8. Coordination with Natural/Man-Made Features. The horizontal alignment should be properly coordinated with the existing alignment at the ends of new projects, natural topography, available right of way, utilities, roadside development and natural/man-made drainage patterns.
9. Environmental Impacts. Horizontal alignment should be properly coordinated to avoid or minimize environmental impacts (e.g., encroachment onto wetlands).
10. Intersections. Horizontal alignment through intersections may present special problems (e.g., intersection sight distance, superelevation development, crossover crowns). See [Chapter 15](#) for the design of intersections.
11. Coordination with Vertical Alignment. [Section 12.2.2](#) discusses general design principles for the coordination between horizontal and vertical alignment.
12. Bridges. Horizontal alignment must be coordinated with the location of bridges. The need for curvature and superelevation development should be evaluated for each bridge location. Avoid superelevation transitions on bridges if possible to facilitate bridge design and construction. Crossing angles between the mainline and other features must also be considered.

11.3 SUPERELEVATION DEVELOPMENT

The *SCDOT Standard Drawings* includes a graphical presentation of typical Department practices for superelevation development (e.g., point of revolution, distribution of superelevation between tangent and curve). Section 11.3 provides an elaboration on Department superelevation practices.

11.3.1 Superelevation Rates

11.3.1.1 Maximum Superelevation Rate

As discussed in [Section 11.2](#), the selection of a maximum rate of superelevation (e_{max}) depends upon several factors. These include design speed, urban/rural location, type of existing or expected roadside development, type of traffic operations expected and prevalent climatic conditions within South Carolina. For new construction/reconstruction projects, [Figure 11.3A](#) summarizes the Department's selection of e_{max} .

11.3.1.2 Superelevation Tables

Based on the selection of e_{max} , [Figures 11.3B](#), [11.3C](#) and [11.3D](#) allow the designer to select the appropriate superelevation rate (e) for any combination of curve radius (R) and design speed (V). Note that the superelevation rates in the tables are expressed as percents.

11.3.1.3 Minimum Radii Without Superelevation

A horizontal curve with a sufficiently large radius does not require superelevation, and the normal crown section (NC) used on tangent can be maintained throughout the curve. On sharper curves for the same design speed, a point is reached where a superelevation rate of 2.08 percent (the normal cross slope) across the total traveled way width is appropriate. This is considered remove adverse crown (RC). For sharper radii, superelevation rates steeper than 2.08 percent are necessary. [Figure 11.3E](#) provides the thresholds or radii ranges for a normal crown (NC) section and remove adverse crown (RC) section at various design speeds.

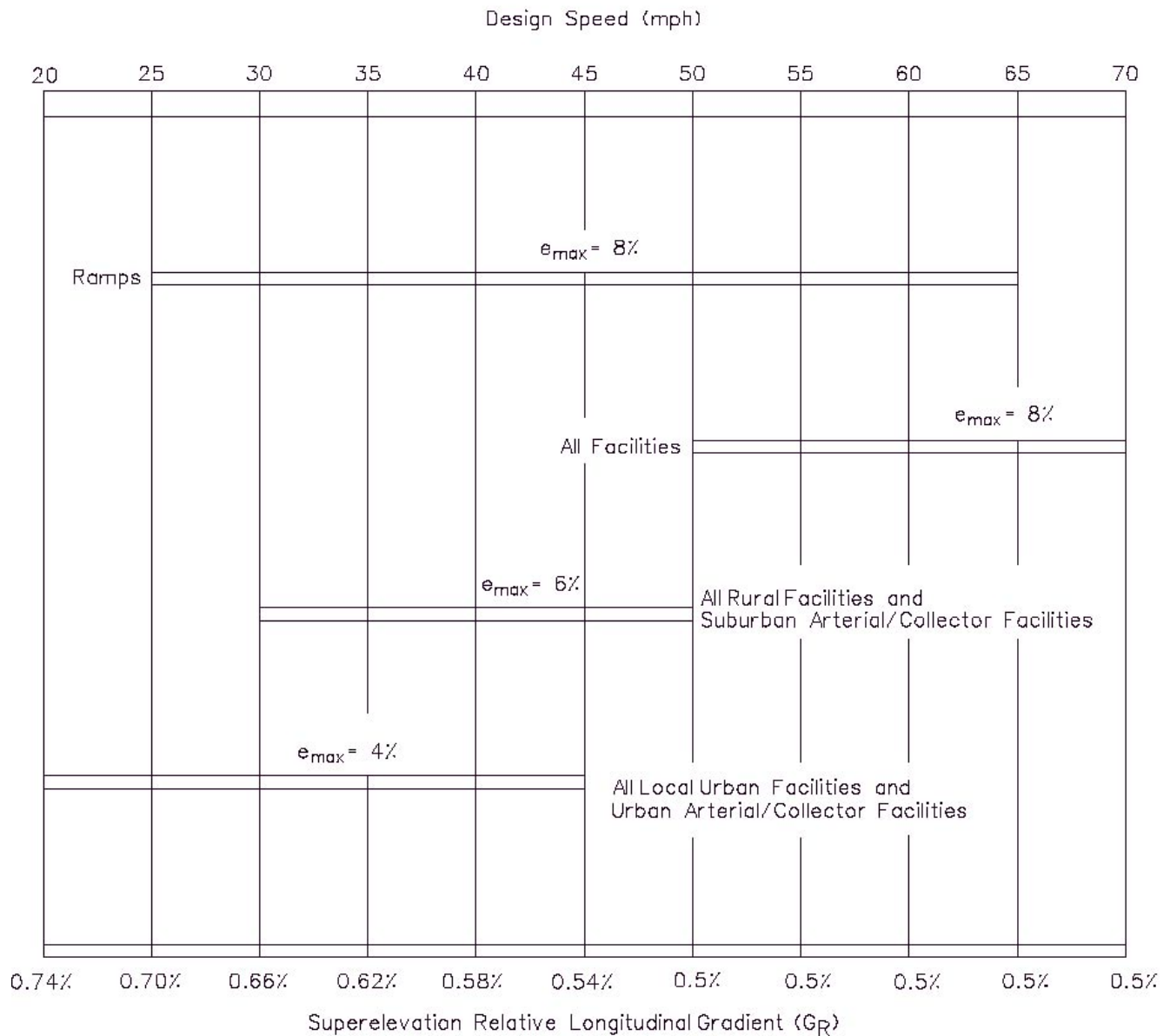

APPLICATION OF e_{max} AND RELATIVE LONGITUDINAL GRADIENTS

Figure 11.3A

Range of Design Speeds for All Facilities changed to 50mph - Revised: 10-2004

Approx. D*	R (ft)	V = 55 mph		V = 60 mph		V = 65 mph		V = 70 mph	
		e (%)	L (ft)	e (%)	L (ft)	e (%)	L (ft)	e (%)	L (ft)
0°15'	23000	NC	0	NC	0	NC	0	NC	0
	20000	NC	0	NC	0	NC	0	NC	0
	17000	NC	0	NC	0	NC	0	NC	0
	14000	NC	0	NC	0	NC	0	RC	50
0°30'	12000	NC	0	NC	0	RC	50	RC	50
	10000	NC	0	RC	50	RC	50	2.1	51
0°45'	8000	RC	50	2.1	51	2.4	58	2.6	63
1°00'	6000	2.4	58	2.7	65	3.1	75	3.4	82
	5000	2.8	68	3.2	77	3.6	87	4.1	99
1°30'	4000	3.4	82	3.9	94	4.4	106	4.9	118
	3500	3.8	92	4.4	106	4.9	118	5.5	132
2°00'	3000	4.3	104	5.0	120	5.6	135	6.3	152
2°30'	2500	5.0	120	5.7	137	6.4	154	7.2	173
3°00'	2000	5.9	142	6.6	159	7.4	178	7.9	190
	1800	6.3	152	7.1	171	7.7	183	R _{min} = 1820 (L = 192)	
3°30'	1600	6.7	161	7.5	180	8.0	192		
4°00'	1400	7.2	173	7.8	188	R _{min} = 1485 (L = 192)			
5°00'	1200	7.7	185	R _{min} = 1205 (L = 192)					
	1000	8.0	192						
	900	R _{min} = 965 (L = 192)							
7°00'	800								

e_{max} = 0.08 or 8.0%

* The roughly approximate degree of curve values are shown for information only. Use the applicable curve radius to determine the design superelevation rate.

Key to Table:

R = Radius of curve in feet.

R_{min} = Calculated minimum radii in feet, which have been rounded to the next highest 5-foot increment.

V = Design speed in miles per hour.

e = Superelevation rate shown as a percent.

L = Minimum length of superelevation runoff in feet from adverse cross slope removed (cross slope of outside lane is level) to full superelevation for a two-lane highway and the point of revolution about the centerline. The calculated tangent runout length must be added to this number. Values in table assume 12-foot lane widths.

NC = Normal crown (2.08 percent typical).

RC = Remove adverse crown (i.e., superelevate traveled way at normal cross slope).

Note: See [Figure 11.3E](#) for more precise radii ranges for NC and RC.

SUPERELEVATION RATE (e) AND MINIMUM LENGTH OF RUNOFF (L) FOR e_{max} = 8.0%

Figure 11.3B

Approx. D*	R (%)	V = 25 mph		V = 30 mph		V = 35 mph		V = 40 mph		V = 45 mph		V = 50 mph	
		e (%)	L (ft)	e (%)	L (ft)	e (%)	L (ft)	e (%)	L (ft)	e (%)	L (ft)	e (%)	L (ft)
0°15'	23000	NC	0	NC	0	NC	0	NC	0	NC	0	NC	0
	20000	NC	0	NC	0	NC	0	NC	0	NC	0	NC	0
	17000	NC	0	NC	0	NC	0	NC	0	NC	0	NC	0
0°30'	14000	NC	0	NC	0	NC	0	NC	0	NC	0	NC	0
	12000	NC	0	NC	0	NC	0	NC	0	NC	0	NC	0
	10000	NC	0	NC	0	NC	0	NC	0	NC	0	NC	0
0°45'	8000	NC	0	NC	0	NC	0	NC	0	NC	0	NC	0
	6000	NC	0	NC	0	NC	0	NC	0	RC	46	RC	50
1°00'	5000	NC	0	NC	0	NC	0	RC	43	RC	46	2.2	53
	4000	NC	0	NC	0	RC	40	RC	43	2.3	51	2.7	65
1°30'	3500	NC	0	NC	0	RC	40	2.1	43	2.6	58	3.0	72
	3000	NC	0	RC	38	RC	40	2.4	50	2.9	64	3.4	82
2°00'	2500	NC	0	RC	38	2.3	45	2.8	58	3.3	73	3.8	92
	2000	RC	36	2.2	40	2.8	54	3.3	68	3.8	84	4.3	104
3°00'	1800	RC	36	2.4	44	3.0	58	3.6	74	4.1	91	4.6	111
	1600	2.1	36	2.7	49	3.3	64	3.8	79	4.4	98	4.9	118
3°30'	1400	2.3	39	2.9	53	3.6	70	4.1	85	4.7	104	5.2	125
	1200	2.6	45	3.3	60	3.9	75	4.5	93	5.0	111	5.6	135
4°00'	1000	3.0	51	3.7	67	4.3	83	4.9	101	5.5	122	5.9	142
	900	3.2	55	3.9	71	4.5	87	5.1	106	5.7	127	6.0	144
7°00'	800	3.4	58	4.1	75	4.8	93	5.4	112	5.9	131	R _{min} = 835 (L = 144)	
8°00'	700	3.7	63	4.4	80	5.1	99	5.7	118	6.0	133		
11°00'	600	4.0	69	4.7	85	5.4	105	5.9	122	R _{min} = 660 (L = 133)			
	500	4.3	74	5.1	93	5.7	110	R _{min} = 510 (L = 124)					
13°00'	450	4.5	77	5.3	96	5.9	114						
14°00'	400	4.8	82	5.6	102	6.0	116						
16°00'	350	5.1	87	5.8	105	R _{min} = 380 (L = 116)							
20°00'	300	5.4	93	6.0	109								
23°00'	250	5.7	98	R _{min} = 275 (L = 109)									
	200	6.0	103										
	150	R _{min} = 185 (L = 103)											

e_{max} = 0.06 or 6.0 %

* The roughly approximate degree of curve values are shown for information only. Use the applicable curve radius to determine the design superelevation rate.

Key to Table:

R = Radius of curve in feet.

R_{min} = Calculated minimum radii in feet, which have been rounded to the next highest 5-foot increment.

V = Design speed in miles per hour.

e = Superelevation rate shown as a percent.

L = Minimum length of superelevation runoff in feet from adverse cross slope removed (cross slope of outside lane is level) to full superelevation for a two-lane highway and the point of revolution about the centerline. The calculated tangent runout length must be added to this number. Values in table assume 12-foot lane widths.

NC = Normal crown (2.08 percent typical).

RC = Remove adverse crown (i.e., superelevate traveled way at normal cross slope).

Note: See Figure 11.3E for more precise radii ranges for NC and RC.

SUPERELEVATION RATE (e) AND MINIMUM LENGTH OF RUNOFF (L) FOR e_{max} = 6.0%

Figure 11.3C

Approx. D*	R (%)	V = 20 mph		V = 25 mph		V = 30 mph		V = 35 mph		V = 40 mph		V = 45 mph	
		e (%)	L (ft)	e (%)	L (ft)	e (%)	L (ft)	e (%)	L (ft)	e (%)	L (ft)	e (%)	L (ft)
0°15'	23000	NC	0	NC	0	NC	0	NC	0	NC	0	NC	0
	20000	NC	0	NC	0	NC	0	NC	0	NC	0	NC	0
	17000	NC	0	NC	0	NC	0	NC	0	NC	0	NC	0
	14000	NC	0	NC	0	NC	0	NC	0	NC	0	NC	0
0°30'	12000	NC	0	NC	0	NC	0	NC	0	NC	0	NC	0
	10000	NC	0	NC	0	NC	0	NC	0	NC	0	NC	0
0°45'	8000	NC	0	NC	0	NC	0	NC	0	NC	0	NC	0
1°00'	6000	NC	0	NC	0	NC	0	NC	0	NC	0	NC	0
	5000	NC	0	NC	0	NC	0	NC	0	NC	0	RC	46
1°30'	4000	NC	0	NC	0	NC	0	NC	0	RC	43	RC	46
	3500	NC	0	NC	0	NC	0	RC	40	RC	43	2.2	49
2°00'	3000	NC	0	NC	0	NC	0	RC	40	2.1	43	2.4	53
2°30'	2500	NC	0	NC	0	RC	38	RC	40	2.4	50	2.6	58
3°00'	2000	NC	0	RC	36	RC	38	2.3	45	2.6	54	2.9	64
	1800	NC	0	RC	36	2.1	38	2.4	46	2.7	56	3.0	67
3°30'	1600	NC	0	RC	36	2.2	40	2.6	50	2.9	60	3.2	71
4°00'	1400	RC	34	RC	36	2.4	44	2.7	52	3.0	62	3.4	76
5°00'	1200	RC	34	2.2	38	2.5	45	2.9	56	3.2	66	3.6	80
	1000	RC	34	2.4	41	2.7	49	3.1	60	3.5	72	3.8	84
	900	2.1	34	2.5	43	2.9	53	3.2	62	3.6	74	3.9	87
7°00'	800	2.2	35	2.6	45	3.0	55	3.4	66	3.8	79	4.0	89
8°00'	700	2.3	37	2.7	46	3.2	58	3.6	70	3.9	81	R _{min} = 735 (L = 89)	
	600	2.5	41	2.9	50	3.4	62	3.8	74	4.0	83		
11°00'	500	2.6	42	3.1	53	3.6	65	3.9	75	R _{min} = 565 (L = 83)			
13°00'	450	2.7	44	3.2	55	3.7	67	4.0	77				
14°00'	400	2.9	47	3.4	58	3.8	69	R _{min} = 425 (L = 77)					
16°00'	350	3.0	49	3.6	62	3.9	71						
20°00'	300	3.2	52	3.7	63	4.0	73	R _{min} = 305 (L = 73)					
23°00'	250	3.4	55	3.9	67								
	200	3.7	60	R _{min} = 205 (L = 69)									
	150	3.9	563										
		R _{min} = 130 (L = 65)											

e_{max} = 0.04 or 4.0 %

* The roughly approximate degree of curve values are shown for information only. Use the applicable curve radius to determine the design superelevation rate.

Key to Table:

R = Radius of curve in feet.

R_{min} = Calculated minimum radii in feet, which have been rounded to the next highest 5-foot increment.

V = Design speed in miles per hour.

e = Superelevation rate shown as a percent.

L = Minimum length of superelevation runoff in feet from adverse cross slope removed (cross slope at outside lane is level) to full superelevation for a two-lane highway and the point of revolution about the centerline. The calculated tangent runout length must be added to this number. Values in table assume 12-foot lane widths.

NC = Normal crown (2.08 percent typical).

RC = Remove adverse crown (i.e., superelevate traveled way at normal cross slope).

Note: See Figure 11.3E for more precise radii ranges for NC and RC.

SUPERELEVATION RATE (e) AND MINIMUM LENGTH OF RUNOFF (L) FOR e_{max} = 4.0%
Figure 11.3D

Design Speed (miles per hour)	Radius of Curve (feet)			
	e_{max}	Normal Crown (NC)	Remove Adverse Crown (RC)	Superelevated Section Required (see applicable e_{max} figure)
20	4%	$R > 1443$	$1443 \geq R > 893$	$R \leq 893$
25	4%	$R > 2099$	$2099 \geq R > 1315$	$R \leq 1315$
30	4%	$R > 2875$	$2875 \geq R > 1817$	$R \leq 1817$
	6%	$R > 3154$	$3154 \geq R > 2166$	$R \leq 2166$
35	4%	$R > 3775$	$3755 \geq R > 2403$	$R \leq 2403$
	6%	$R > 4134$	$4134 \geq R > 2845$	$R \leq 2845$
40	4%	$R > 4801$	$4801 \geq R > 3074$	$R \leq 3074$
	6%	$R > 5249$	$5249 \geq R > 3619$	$R \leq 3619$
45	4%	$R > 5955$	$5955 \geq R > 3833$	$R \leq 3833$
	6%	$R > 6499$	$6499 \geq R > 4489$	$R \leq 4489$
50	6%	$R > 7886$	$7886 \geq R > 5456$	$R \leq 5456$
55	8%	$R > 9735$	$9735 \geq R > 6869$	$R \leq 6869$
60	8%	$R > 11,466$	$11,466 \geq R > 8104$	$R \leq 8104$
65	8%	$R > 12,904$	$12,904 \geq R > 9145$	$R \leq 9145$
70	8%	$R > 14,439$	$14,439 \geq R > 10,263$	$R \leq 10,263$

**MINIMUM RADII FOR NORMAL CROWN (NC) AND
REMOVE ADVERSE CROWN (RC) SECTIONS**

Figure 11.3E

11.3.2 Transition Lengths

As defined in [Section 11.1](#), the superelevation transition length is the distance required to transition the roadway from a normal crown section to the full design superelevation rate. The superelevation transition length is the sum of the tangent runout distance (TR) and superelevation runoff length (L).

11.3.2.1 Calculation

Six-lane divided freeways require special considerations. See the discussion below.

1. Superelevation Runoff. The e_{\max} tables ([Figures 11.3B through 11.3D](#)) present the superelevation runoff lengths (L) for two-lane highways. Superelevation runoff lengths for two-lane and multi-lane facilities are calculated as follows:

$$L = \frac{(e)(W)}{G_R} \quad \text{(Equation 11.3.1)}$$

Where:

- L = Minimum superelevation runoff length (assuming the point of revolution is about the roadway centerline), feet
- e = Design superelevation rate, decimal
- W = Distance between the point of revolution and the outside edge of the traveled way, feet*
- G_R = Relative longitudinal gradient between the profile grade and the edge of adjacent travel lane, decimal (see [Figure 11.3A](#))

* The L values in [Figures 11.3B through 11.3D](#) for two-lane highways have been calculated assuming that the width (W) is 12 feet. For a four-lane highway with a depressed median and where each roadway is crowned about the centerline and on independent alignment, W will be 12 feet. For a typical urban multilane highway with a flush median or two-way, left-turn lane (i.e., the crown is in the center of the flush median or TWLTL), W will be the distance from the crown (or point of revolution) to the outside edge of traveled way. In Chapter 19, [Figures 19.2A, 19.2B and 19.2C](#) present typical cross sections for freeways. For all three sections, W is 36 feet, because the two points of revolution are about the inside edge of the two inside (or future) travel lanes.

2. Tangent Runout. The tangent runout distance will be calculated using the following:

$$TR = \frac{S_{\text{normal}}}{e} (L) \quad (\text{Equation 11.3.2})$$

Where:

TR = Minimum tangent runout length (assuming the point of revolution is about the roadway centerline), feet

S_{normal} = Normal cross slope (typically 0.0208), decimal

L = Superelevation runoff length, feet (See Equation 11.3.1)

e = Design superelevation rate, decimal

3. Superelevation Transition Length. Once the tangent runout (TR) distance is calculated, this distance is added to the design superelevation runoff length (L). The total of these two numbers equals the theoretical superelevation transition length used for design.
4. Six-Lane Divided Freeways. In Chapter 19, [Figures 19.2B](#) and [19.2C](#) present two typical cross sections on tangent for a six-lane divided freeway. The designer must devote special consideration to superelevation development on these facilities. The first objective is to transition the highway from the typical cross section to a section that slopes at a uniform rate across the traveled way in the same direction. This transition must be achieved to meet certain criteria and principles, including:
- Rate of Transition. The rate of transition (i.e., the relative longitudinal gradient) should be the same as that for the superelevation runoff.
 - Point of Revolution. [Section 11.3.3.2](#) discusses the point of revolution for multilane highways. However, an “initial” point of revolution (and sometimes more than one) must be selected to remove any crown and achieve a plane section. This will often be a point other than that used for the “primary” point of revolution to transition from the uniform cross slope to the design superelevation rate. For example, the Typical Section on [Figure 19.2B](#) presents a cross slope of 2.08 percent (48H:1V) for the center and inside travel lane and a cross slope of 2.78 percent (36H:1V) for the outside travel lane. The outside travel lane must be transitioned from a 2.78 percent slope to a 2.08 percent slope. To accomplish this, there will be an “initial” point of revolution at the line between the center and outside travel lanes.

- c. Tangent Runout. The end of the tangent runout occurs where the outside travel lane(s) are level. For a typical section such as in [Figure 19.2B](#), two separate calculations will be necessary to determine the tangent runout length. Also note that the initial part of the superelevation runoff is used to transition from the end of the tangent runout to a roadway section with a uniform slope.

11.3.2.2 Application of Transition Length

Once the superelevation runoff and tangent runout have been calculated, the designer must determine how to fit the length into the horizontal and vertical planes. The following will apply:

1. Simple Curves. Typically for new construction/reconstruction projects, 67 percent of the superelevation runoff length will be placed on the tangent and 33 percent on the curve. Exceptions to this practice may be necessary to meet field conditions. The generally accepted range is 60 percent to 80 percent on the tangent and 40 percent to 20 percent on the curve. In extreme cases (e.g., to avoid placing any superelevation transition on a bridge or approach slab), the superelevation runoff may be distributed 50 percent to 100 percent on the tangent and 50 percent to 0 percent on the curve. This will usually occur only in urban or suburban areas with highly restricted right of way conditions. When considering the tangent runout distance, this results in a distribution of the total superelevation transition length of approximately 75 percent on the tangent and 25 percent on the curve. However, because the distribution of the superelevation transition length is not an exact science, the ratio should be rounded slightly (e.g., to the nearest 5-foot increment) to simplify design and layout in construction.
2. Field Application (Vertical Profile). At the beginning and end of the superelevation transition length, angular breaks occur in the profile at the edge of the pavement if not smoothed. Field personnel usually smooth these abrupt angular breaks out during construction. This is usually accomplished by visually adjusting the wire used to control the vertical and horizontal position of the blacktop spreader or slip-form paver.

As a guide, the vertical curve transitions, to eliminate angular breaks, should have a length in feet numerically equivalent to the approximate design speed in miles per hour ± 10 feet with 40 feet as a minimum. In addition, designers should graphically or numerically investigate the transition areas to identify potential flat spots for drainage before finalizing construction plans. When the edge of pavement profile is adjusted, the cross slopes and elevations on the cross sections should reflect these changes.

3. Ultimate Development. If the proposed facility is planned for an ultimate development of additional lanes, the designer should, where practical, reflect this length in the initial superelevation transition application. For example, a four-lane divided facility may be planned for an ultimate six-lane divided facility. Therefore, the superelevation transition length for the initial four-lane facility should be consistent with the future requirements of the six-lane facility. See [Section 11.3.3](#) for more discussion.

11.3.3 Point of Revolution

The following discusses the point of revolution for two-lane, two-way highways and multilane highways. The *SCDOT Standard Drawings* presents typical figures illustrating the application of the point of revolution in superelevation development.

11.3.3.1 Two-Lane, Two-Way Highways

The point of revolution will typically be about the centerline of the roadway on two-lane, two-way highways. This method will yield the least amount of elevation differential between the pavement edges and their normal profiles. Occasionally, it may be necessary to revolve about the inside or outside edge of the traveled way. This may be necessary to meet field conditions (e.g., drainage on a curbed facility, roadside development). Note that, as discussed in [Section 11.3.2.1](#), revolution about the edge of traveled way will require an increase in the superelevation runoff and tangent runout lengths.

On a two-lane highway with an auxiliary lane (e.g., a climbing lane), the point of revolution will typically be about the centerline of the two through lanes.

11.3.3.2 Multilane Highways

Several highway features may significantly influence superelevation development for multilane highways. These include guardrail, median barriers, drainage and major at-grade intersections. The designer should carefully consider the intended function of all highway features and insure that the superelevated section and selected point of revolution does not compromise traffic operations. In addition, the designer should consider the likely ultimate development of the facility and select a point of revolution that will lend itself to future expansion.

The following summarizes typical Departmental practices for selecting the point of revolution on multilane facilities:

1. Undivided Facilities. Revolve about the centerline of the entire roadway section.
2. Flush Medians. Revolve about the centerline of the entire roadway section. Note that this also applies to two-way, left-turn lane sections.
3. Raised Medians. Revolve about the centerline of the entire roadway section.
4. Depressed Medians. On new construction projects, where the median width is sufficient for two additional future lanes, the point of revolution will be about the two inside edges of the two future travel lanes.

For projects on existing multilane divided facilities with a depressed median, where there is no anticipation of adding future travel lanes in the median, the point of revolution will be about the two edges of the existing median (i.e., the median will remain in a horizontal plane through the superelevated curve).

5. Independent Roadways. On multilane divided facilities where the median is sufficiently wide (i.e., the two roadways are on independent alignments), the points of revolution will be about the centerlines of the two roadways.

11.3.4 Shoulder Treatment on Superelevated Curves

1. Low Side. On new construction projects, the low side shoulder will be transitioned to match the slope rate and direction of the adjacent travel lane when the slope rate exceeds the normal shoulder slope.
2. High Side. The high-side shoulder will be transitioned to match the slope rate and direction of the adjacent travel lane throughout the curve.

11.3.5 Compound Curves

As discussed in [Section 11.2.2.3](#), compound curves should rarely be used on mainline and, then, only two-centered curves should be used. When used, the development of superelevation requires special considerations. These criteria should be met:

1. If the distance between the PC and PCC is less than or equal to 300 feet, use a uniform longitudinal gradient throughout the transition. Develop the superelevation so that, for the first curve, two-thirds of the design superelevation rate for this curve will be attained at the PC. Develop the superelevation so that, for the second curve, the design superelevation rate will be available at the PCC.
2. If the distance between the PC and PCC is more than 300 feet, it may be preferable to consider the two curves separately. Superelevation for the entering curve is developed by the distribution method used for simple curves. This curve's superelevation rate will then be maintained until it is necessary to

develop the remaining superelevation of the second curve as consistent with the Department's superelevation development practices (e.g., for the relative longitudinal gradient).

11.3.6 Reverse Curves

Reverse curves are two closely spaced simple curves with deflections in opposite directions. In some situations, because of the proximity of the curves, it is not possible to adhere to the standard superelevation development criteria for each curve and achieve a normal tangent section between the curves. If this is the case, the designer should use the following steps to adjust the superelevation development:

1. Determine the point where the transitions should meet. The length of transition should favor the curve with the smaller (sharper) radius. Assume that, for the first iteration, the cross slope at this point is the normal crown (2.08 percent, typically).
2. Determine the relative longitudinal gradient (G_R) from [Figure 11.3A](#).
3. Apply the superelevation rate while maintaining G_R and working back from the point determined in Step 1.
4. Examine the superelevation of the curves to insure that:
 - no more than 40 percent of the transitions occur in either curve, and
 - the length of full superelevation on each curve is sufficient.
5. If either of the criteria set forth in Step 4 are not met, recalculate the superelevation with the normal cross slope reduced to no less than 1 percent.

If the superelevation still cannot be developed properly, the designer should consider revising the alignment or possibly adjusting the design speed.

[Figure 11.3G](#) illustrates superelevation development for reverse curves.

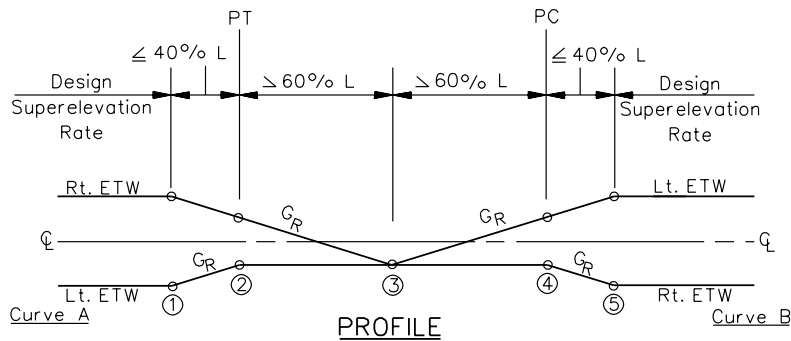
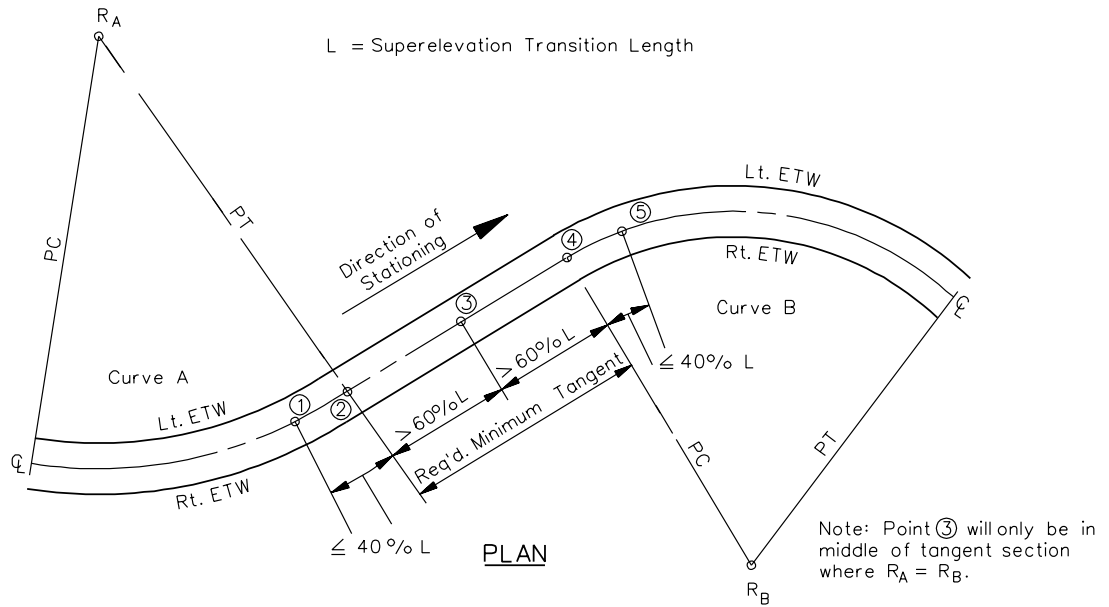

$e_A = \text{Design Superelevation Rate for Curve A}$
 $e_B = \text{Design Superelevation Rate for Curve B}$

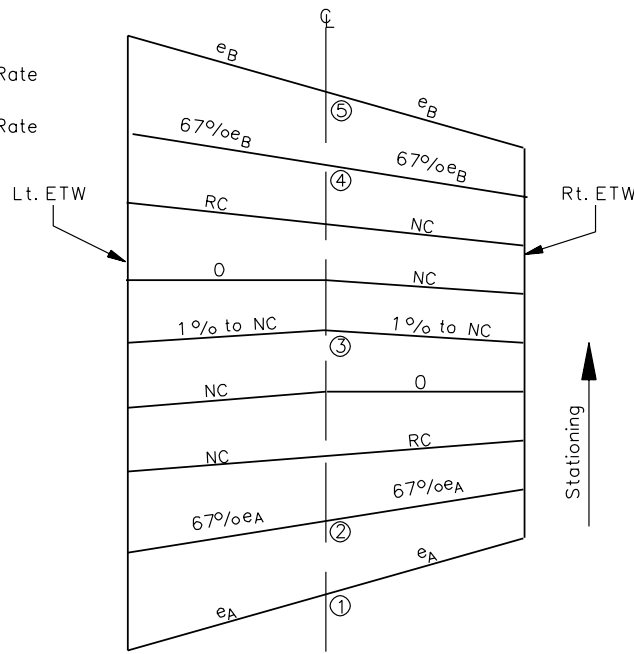

CROSS SECTIONS

SUPERELEVATION DEVELOPMENT FOR REVERSE CURVES

Figure 11.3G

11.3.7 Bridges

From the perspective of the roadway user, a bridge is an integral part of the roadway system and, ideally, horizontal curves and their transitions will be located irrespective of their impact on bridges. However, practical factors in bridge design and bridge construction warrant consideration in the location of horizontal curves at bridges. The following presents, in order from the most desirable to the least desirable, the application of horizontal curves to bridges:

1. Considering both the complexity of design and construction difficulty, the most desirable treatment is to locate the bridge and its approach slabs on a tangent section (i.e., no portion of the curve or its superelevation development will be on the bridge or bridge approach slabs).
2. If a horizontal curve is located on a bridge, the superelevation transition should not be located on the bridge or its approach slabs. This will result in a uniform cross slope (i.e., the design superelevation rate) throughout the length of the bridge and bridge approach slabs.
3. If the superelevation transition is located on the bridge or its approach slabs, the designer should place on the roadway approach that portion of the superelevation development which transitions the roadway cross section from its normal crown to a point where the roadway slopes uniformly (i.e., to a point where the crown has been removed). This will avoid the need to warp the crown on the bridge or the bridge approach slabs.

11.3.8 Drainage

Two potential pavement surface drainage problems are of concern in the superelevation transition section. One problem relates to the potential lack of adequate longitudinal grade. This problem generally occurs where the longitudinal gradient of the point of revolution is equal to, but opposite in sign to, the relative longitudinal gradient for the superelevation transition (e.g., 0.50 percent). It results in the edge of traveled way having negligible longitudinal grade, which can lead to poor pavement surface drainage, especially on curbed cross sections.

The second potential drainage problem relates to adequate lateral drainage due to negligible cross slope during pavement rotation. This problem occurs in the transition section where the cross slope of the outside lane varies from an adverse slope at the normal cross slope rate to a superelevated slope at the normal cross slope rate. This length of the transition section includes the tangent runoff section and an equal length of the superelevation runoff section. Within this length, the pavement cross slope may not be sufficient to adequately drain the pavement laterally.

Two techniques can be used to alleviate these two potential drainage problems. One technique is to provide a minimum profile (finished) grade in the transition section. The second technique is to provide a minimum edge-of-traveled-way grade in the transition section. Both techniques can be incorporated in the design by use of the following criteria:

1. Maintain a minimum profile (finished) grade of 0.5 percent through the transition section.
2. Maintain a minimum edge-of-traveled-way grade of 0.2 percent (0.5 percent for curbed streets) through the transition section.

To illustrate the combined use of the two grade criteria, consider an uncurbed roadway curve having a relative longitudinal gradient of +0.50 percent in the superelevation transition section entering the curve and -0.50 percent for the superelevation transition section exiting the curve. The first criterion would exclude finished grades between -0.50 and +0.50 percent. The second criterion would exclude finished grades in the range of -0.30 to -0.70 percent (entering) and those in the range of +0.30 to +0.70 percent (exiting). Given the overlap between the ranges for controls 1 and 2, the profile (finished) grade throughout the curve must be outside of the range of -0.70 to +0.70 percent to satisfy both criteria and provide adequate pavement surface damage.

11.4 HORIZONTAL SIGHT DISTANCE

11.4.1 Sight Obstruction (Definition)

Sight obstructions on the inside of a horizontal curve are defined as obstacles that interfere with the line of sight on a continuous basis. These include walls, cut slopes, wooded areas, buildings and high farm crops. In general, point obstacles (e.g., traffic signs, utility poles) are not considered sight obstructions on the inside of horizontal curves. The designer must examine each curve individually to determine whether it is necessary to remove an obstruction or adjust the horizontal alignment to obtain the required sight distance.

11.4.2 Length > Stopping Sight Distance

Where the length of curve (L) is greater than the stopping sight distance (SSD) used for design, the needed clearance on the inside of the horizontal curve is calculated as follows:

$$M = R \left(1 - \cos \left[\frac{28.65 \text{ SSD}}{R} \right] \right) \quad \text{(Equation 11.4.1)}$$

Where:

- | | | |
|-----|---|---|
| M | = | Middle ordinate, or distance from the center of the inside travel lane to the obstruction, feet |
| R | = | Radius of curve at the center of inside lane, feet |
| SSD | = | Stopping sight distance, feet |

11.4.2.1 Stopping Sight Distance (SSD)

At a minimum, SSD will be available throughout the horizontal curve. The following discusses the application of SSD to sight distance at horizontal curves:

1. Level Grade. [Figure 11.4A](#) provides the horizontal clearance criteria (i.e., middle ordinate) for various combinations of stopping sight distance (see [Figure 10.1A](#)) and curve radii for level grades. For those selections of SSD that fall outside of the figures (i.e., $M > 40$ feet and/or $R < 100$ feet), the designer should use [Equation 11.4.1](#) to calculate the needed clearance.
2. Grade Adjustment. [Figure 10.1C](#) presents SSD values for passenger cars adjusted for 3 to 10 percent up and downgrades. If the up or downgrade on the facility is 3 percent or steeper, the designer should consider providing horizontal clearances adjusted for grade. These SSD values should be used directly in [Equation 11.4.1](#) to calculate the middle ordinate.

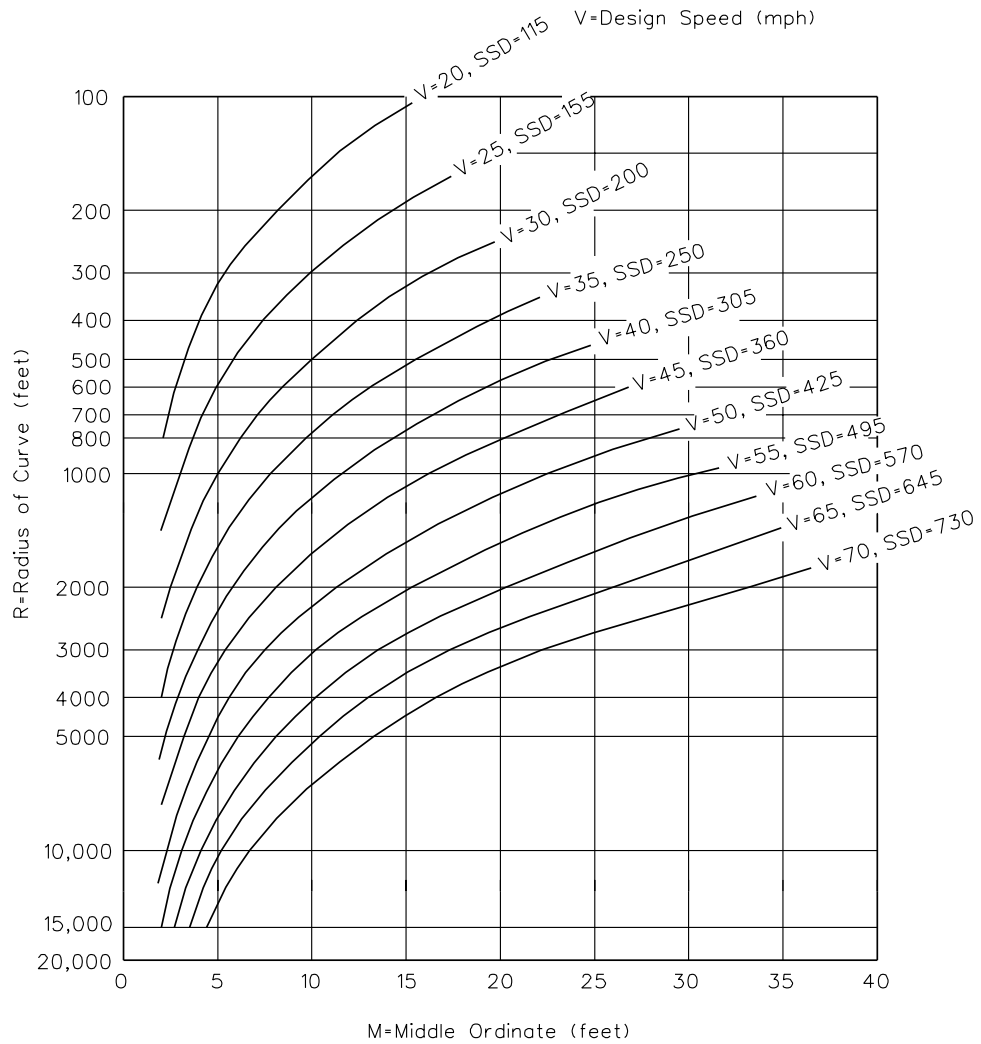
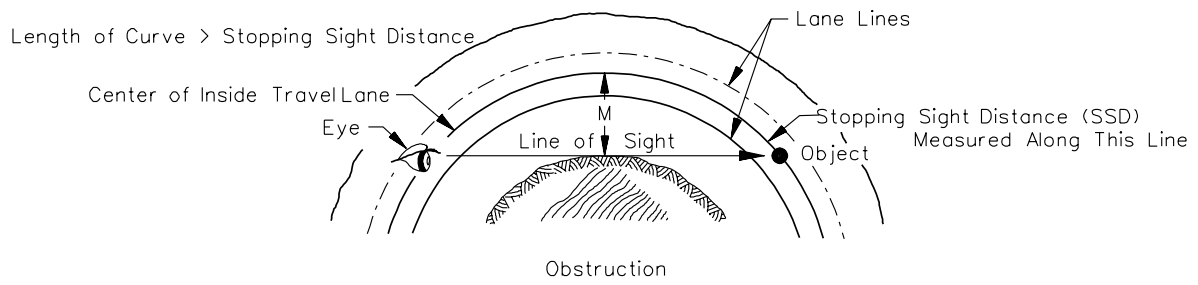

**STOPPING SIGHT DISTANCE AT HORIZONTAL CURVES
(Level Grades)**

Figure 11.4A

11.4.2.2 Entering/Exiting Portions (Typical Application)

The M values from [Figure 11.4A](#) apply between the PC and PT. In addition, some transition is needed on the entering and exiting portions of the curve. [Example 11.4\(1\)](#) (See [Figure 11.4B](#)) illustrates the determination of clearance requirements for the entering and exiting portions of a curve. The designer should use the following steps:

- Step 1: Locate the point that is on the outside edge of shoulder and a distance of SSD/2 before the PC.
- Step 2: Locate the point which is a distance M measured laterally from the center of the inside travel lane at the PC.
- Step 3: Connect the two points located in Steps 1 and 2. The area between this line and the roadway should be clear of all continuous obstructions.
- Step 4: A symmetrical application of Steps 1 through 3 should be used beyond the PT.

11.4.3 Length < Stopping Sight Distance

When the length of curve is less than the stopping sight distance used in design, the M value from the basic equation will never be reached. As an approximation, the horizontal clearance for these curves should be determined as follows:

- Step 1: For the given R and SSD, calculate M assuming $L > SSD$.
- Step 2: The maximum M' value will be needed at a point of L/2 beyond the PC. M' is calculated from the following proportion:

$$\frac{M'}{M} = \frac{1.2L}{SSD} \quad (\text{Equation 11.4.2})$$

$$M' = \frac{1.2(L)(M)}{SSD}$$

- Where:
- M' = Middle ordinate for a curve where $L < SSD$, feet
 - M = Middle ordinate for the curve based on Equation 11.4.1, feet
 - L = Length of the curve, feet
 - SSD = Stopping sight distance, feet

- Step 3: Locate the point that is on the outside edge of shoulder and a distance of $SSD/2$ before the PC.
- Step 4: Connect the two points located in Steps 2 and 3. The area between this line and the roadway should be clear of all continuous obstructions.
- Step 5: A symmetrical application of Steps 2 through 4 should be used on the exiting portion of curve.

Example 11.4(2) ([See Figure 11.4C](#)) illustrates the determination of clearance requirements for the entering and exiting portions of a curve where $L < SSD$.

11.4.4 Application

For sight distance applications at horizontal curves, the height of eye is 3.5 feet and the height of object is 2 feet. Both the eye and object are assumed to be in the center of the inside travel lane. The line-of-sight intercept with the obstruction is at the midpoint of the sightline and 2.75 feet above the center of the inside lane.

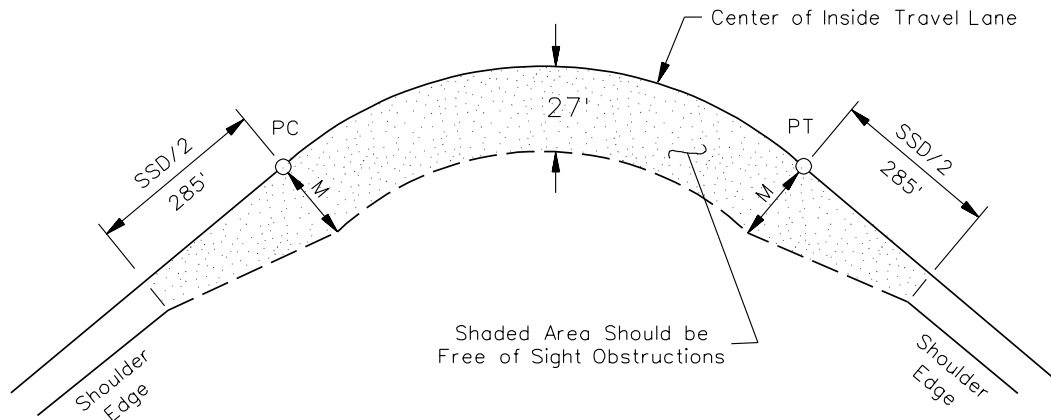

Example 11.4(1)

Given: Design Speed = 60 miles per hour
 $R = 1500$ feet
 Level Grade

Problem: Determine the horizontal clearance requirements for a horizontal curve on a two-lane highway using SSD.

Solution: Figure 10.1A yields a $SSD = 570$ feet. Using Equation 11.4.1 for horizontal clearance ($L > SSD$):

$$M = R \left(1 - \cos \left[\frac{28.65 \text{ SSD}}{R} \right] \right)$$

$$M = 1500 \left(1 - \cos \left[\frac{(28.65)(570)}{1500} \right] \right) = 27 \text{ feet}$$

The above figure also illustrates the horizontal clearance requirements for the entering and exiting portion of the horizontal curve.

SIGHT CLEARANCE REQUIREMENTS FOR HORIZONTAL CURVES ($L > SSD$)

Figure 11.4B

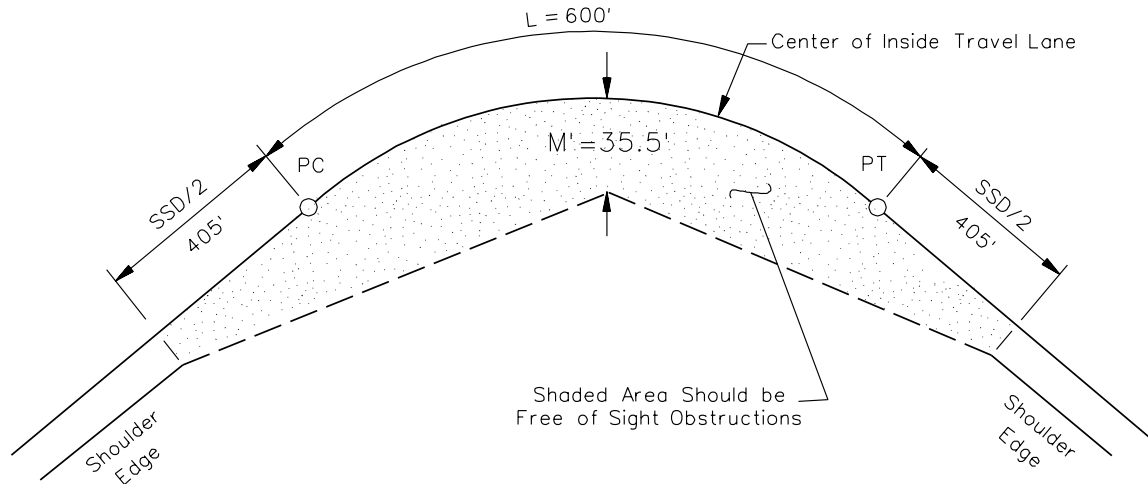

Example 11.4(2)

Given: Design Speed = 70 miles per hour
 R = 2050 feet
 L = 600 feet
 Grade = 5.0 percent downgrade

Problem: Determine the clearance requirements for the horizontal curve on a two-lane highway.

Solution: Because the downgrade is greater than 3.0 percent, the curve should desirably be adjusted for grade. [Figure 10.1C](#) yields a SSD of 810 feet for 70 miles per hour and a 5.0 percent downgrade. Therefore, $L < SSD$ (600 feet < 810 feet), and the horizontal clearance is calculated from [Equation 11.4.2](#) as follows:

$$M(L > SSD) = 2050 \left[1 - \cos \frac{(28.65)(810)}{2050} \right] = 39.88 \text{ feet}$$

$$M'(L < SSD) = \frac{1.2(600)(39.88)}{810}$$

$$M' = 35.5 \text{ feet}$$

Therefore, a minimum clearance of 35.5 feet should be provided at a distance of $L/2 = 300$ feet beyond the PC. The obstruction-free triangle around the horizontal curve would be defined by M' (35.5 feet) at $L/2$ and by points at the shoulder edge at $SSD/2 = 405$ feet before the PC and beyond the PT.

SIGHT CLEARANCE REQUIREMENTS FOR HORIZONTAL CURVES (L < SSD)

Figure 11.4C

11.5 REFERENCES

1. *A Policy on Geometric Design of Highways and Streets*, AASHTO, 2001.

Table of Contents

<u>Section</u>	<u>Page</u>
12.1 DEFINITIONS	12.1(1)
12.2 DESIGN PRINCIPLES AND PROCEDURES	12.2(1)
12.2.1 General Controls for Vertical Alignment	12.2(1)
12.2.2 Coordination of Horizontal and Vertical Alignment	12.2(2)
12.2.3 Design of Profile Grade Lines	12.2(3)
12.2.3.1 General	12.2(3)
12.2.3.2 Profile Grade Line Locations	12.2(4)
12.2.3.3 Factors Affecting the Design of Profile Grade Lines.....	12.2(5)
12.3 GRADES	12.3(1)
12.3.1 Maximum Grades	12.3(1)
12.3.2 Minimum Grades	12.3(1)
12.3.3 Critical Length of Grade	12.3(1)
12.4 TRUCK-CLIMBING LANES	12.4(1)
12.4.1 Guidelines	12.4(1)
12.4.1.1 Two-Lane Highways.....	12.4(1)
12.4.1.2 Multilane Highways	12.4(1)
12.4.2 Capacity Analysis	12.4(2)
12.4.3 Design Guidelines	12.4(2)
12.4.4 Downgrades	12.4(5)
12.4.5 Truck Speed Profile.....	12.4(5)
12.5 VERTICAL CURVES	12.5(1)
12.5.1 Crest Vertical Curves	12.5(1)
12.5.1.1 Equations	12.5(1)
12.5.1.2 Stopping Sight Distance	12.5(1)
12.5.1.3 Passing Sight Distance	12.5(2)
12.5.1.4 Drainage	12.5(5)

Table of Contents

(Continued)

<u>Section</u>	<u>Page</u>
12.5.2 Sag Vertical Curves	12.5(5)
12.5.2.1 Equations	12.5(5)
12.5.2.2 Stopping Sight Distance.....	12.5(6)
12.5.2.3 Comfort Criteria.....	12.5(8)
12.5.2.4 Underpasses.....	12.5(8)
12.5.2.5 Drainage	12.5(9)
12.5.3 Vertical Curve Computations.....	12.5(9)
12.6 VERTICAL CLEARANCES.....	12.6(1)
12.7 REFERENCES.....	12.7(1)

Chapter Twelve

VERTICAL ALIGNMENT

The vertical alignment contributes significantly to a highway's safety, aesthetics, operations and costs. Long, gentle vertical curves provide greater sight distances and a more pleasing appearance for the driver. [Chapters 19 through 22](#) provide numerical criteria for various vertical alignment elements based on highway functional class, project scope of work and urban/rural location. This Chapter provides additional guidance on these and other vertical alignment elements, including developing a profile grade line, maximum and minimum grades, critical lengths of grade, truck-climbing lanes, vertical curvature and vertical clearances.

12.1 DEFINITIONS

1. Broken-Back Curves. A grade line with two vertical curves in the same direction separated by a short section of tangent grade.
2. Bus. A heavy vehicle involved in the transport of passengers on a for-hire, charter or franchised transit basis. Also, can be called a motor coach.
3. Critical Length of Grade. The maximum length of a specific upgrade on which a loaded truck can operate without an unreasonable reduction in speed.
4. Grade Slopes. The slope expressed as a percent between two adjacent VPI's. The numerical value for the grade is the vertical rise or fall in feet for each foot of horizontal distance. The numerical value is multiplied by 100 and is expressed as a percent. Upgrades in the direction of stationing are identified as positive (+). Downgrades are identified as negative (-).
5. Heavy Vehicles. Any vehicle with more than four wheels touching the pavement during normal operation. Heavy vehicles collectively include trucks, recreational vehicles and buses.
6. K-Values. The horizontal distance needed to produce a 1 percent change in gradient.
7. Level Terrain. Level terrain generally is considered to be flat and has minimal impact on vehicular performance. Highway sight distances in level terrain generally can be made longer without major construction expense.
8. Momentum Grade. Sites where an upgrade is preceded by a downgrade. These locations allow a truck to increase its speed on the downgrade before ascending the upgrade.

9. Mountainous Terrain. Locations where longitudinal and transverse changes in elevation are abrupt, and benching and side hill excavation are usually required to provide the desirable horizontal and vertical alignment. Mountainous terrain aggravates the performance of trucks relative to passenger cars and results in some trucks operating at crawl speeds.
10. Performance Curves. A set of curves that illustrate the effect grades will have on the design vehicle's acceleration and/or deceleration.
11. Profile Grade Line. A series of tangent lines connected by vertical curves. Typically, the grade line is located along the roadway centerline of undivided multilane facilities and two-lane, two-way highways.
12. Recreational Vehicle. A heavy vehicle, generally operated by a private motorist, engaged in the transportation of recreational equipment or facilities; examples include campers, boat trailers, motorcycle trailers, etc.
13. Rolling Terrain. Locations where the natural slopes consistently rise above and fall below the roadway grade line and, occasionally, steep grades present some restriction to the desirable horizontal and vertical alignment. In general, rolling terrain generates steeper grades causing trucks to reduce speeds below those of passenger cars.
14. Truck. A heavy vehicle engaged primarily in the transport of goods and materials or in the delivery of services other than public transportation. For geometric design and capacity analyses, trucks are defined as vehicles with six or more tires. Data on trucks is compiled and reported by Roadway Data Services in the Traffic Engineering Division.
15. VPC (Vertical Point of Curvature). The point at which a tangent grade ends and the vertical curve begins.
16. VPI (Vertical Point of Intersection). The point where the extension of two tangent grades intersect.
17. VPT (Vertical Point of Tangency). The point at which the vertical curve ends and the tangent grade begins.

12.2 DESIGN PRINCIPLES AND PROCEDURES

12.2.1 General Controls for Vertical Alignment

As discussed in this Chapter, the design of vertical alignment involves, to a large extent, complying with specific limiting criteria. These criteria include maximum and minimum grades, sight distance at vertical curves and vertical clearances. In addition, the designer should adhere to certain general design principles and controls that will determine the overall safety and operation of the facility and will enhance the aesthetic appearance of the highway. These design principles for vertical alignment include:

1. Consistency. Use a smooth grade line with gradual changes, consistent with the type of highway and character of terrain.
2. Coordination with Natural/Man-Made Features. The vertical alignment should be properly coordinated with the natural topography, available right of way, utilities, roadside development and natural/man-made drainage patterns. This is especially important in mountainous terrain.
3. Roller Coaster. Avoid a “roller-coaster” type of profile, especially where the horizontal alignment is relatively straight. This type of profile may be proposed in the interest of economy, but it is aesthetically undesirable. To avoid this type of profile, incorporate horizontal curvature and/or flatter grades that may require greater excavations and higher embankments into the design.
4. Broken-Back Curvature. Avoid “broken-back” grade lines (two crest or sag vertical curves separated by a short tangent). This alignment is particularly noticeable on divided highways with open-ditch median sections. One long vertical curve is more desirable.
5. Long Grades. On a long ascending grade, it is preferable to place the steepest grade at the bottom and flatten the grade near the top. It is also preferable to break the sustained grade with short intervals of flatter grades. Evaluate substantial lengths of grades for their effect on traffic operations (e.g., trucks).
6. Sags. Avoid sag vertical curves in cuts unless adequate drainage can be provided. Also, avoid drainage problems on bridges by not placing the low point of a sag vertical curve on a bridge.
7. Intersections. Maintain moderate grades through intersections to facilitate braking and turning movements. See [Section 15.2.7](#) for specific information on vertical alignment through intersections.
8. Environmental Impacts. Vertical alignment should be properly coordinated with environmental impacts. However, the safety of motorists using the highway should not be compromised.

12.2.2 Coordination of Horizontal and Vertical Alignment

Horizontal and vertical alignments should not be designed independently. Instead they should complement each other. This is especially true for new construction projects. A thorough study of the alignment is always warranted.

Horizontal and vertical alignments are among the most important design elements for a highway. Excellence in their design and coordination increases the highway's utility and safety, encourages uniform speeds, and can greatly improve the highway's appearance. This usually can be accomplished with little additional costs. The designer should coordinate the layout of the horizontal and vertical alignment as early as practical in the design process.

In addition, consider the following when coordinating horizontal and vertical alignment on rural and suburban highways:

1. **Balance.** Horizontal curvature and grades should be in proper balance. Maximum curvature with flat grades or flat curvature with maximum grades does not achieve this desired balance. A compromise between the two extremes produces the best design relative to safety, capacity, ease and uniformity of operations and aesthetics.
2. **Coordination.** Vertical curvature superimposed upon horizontal curvature (i.e., vertical and horizontal PI's at approximately the same stations) generally results in a more pleasing appearance and reduces the number of sight distance restrictions. Successive changes in profile not in combination with horizontal curvature may result in a series of humps visible to the driver for some distance, which may produce an unattractive design. However, in some circumstances, superimposing the horizontal and vertical alignment must be tempered somewhat by [Comments 3 and 4](#) below.
3. **Crest Vertical Curves.** Do not introduce sharp horizontal curvature at or near the top of pronounced crest vertical curves. This is undesirable because the driver cannot perceive the horizontal change in alignment, especially at night when headlight beams project straight ahead into space. This problem can be avoided if the horizontal curvature leads the vertical curvature or by using design values which well exceed the minimums.
4. **Sag Vertical Curves.** Do not introduce sharp horizontal curves at or near the low point of pronounced sag vertical curves or at the bottom of steep grades. Because visibility of the road ahead is foreshortened, only flat horizontal curvature will avoid an undesirable, distorted appearance. At the bottom of long grades, vehicular speeds often are higher, particularly for trucks, and erratic operations may occur, especially at night and during icy conditions.

5. Passing Sight Distance. In some cases, the need for frequent passing opportunities and a higher percentage of passing sight distance may supersede the desirability of combining horizontal and vertical alignment. In these cases, it may be necessary to provide long tangent sections to secure sufficient passing sight distance; see [Chapter 10](#).
6. Superelevation. When vertical and horizontal curves are superimposed, the superelevation may cause a distortion in the outer pavement edges. For curb and gutter sections, plot and review the profile along the top of curb and remove any irregularities with a smooth vertical curve.
7. Intersections. At intersections, horizontal and vertical alignment should be as flat as practical to provide a design which produces sufficient sight distance and gradients for vehicles to slow, stop or turn; see [Chapter 15](#).
8. Divided Highways. On divided facilities with wide medians, it may be advantageous to provide independent alignments for the two one-way roadways. Where traffic volumes justify a divided facility, and rolling or rugged terrain exists, a superior design can result from the use of independent alignments and profiles.
9. Residential Areas. For highways near subdivisions, design the alignment and profile to minimize nuisance factors to neighborhoods. For freeways, a depressed facility can make the highway less visible and reduce the noise to adjacent residents. Also, for all highway types, minor adjustments to the horizontal alignment may increase the buffer zone between the highway and residential areas.
10. Aesthetics. Design the alignment to enhance attractive scenic views of rivers, rock formations, parks, golf courses, etc. The highway should head into rather than away from those views that are considered to be aesthetically pleasing. The highway should fall towards those features of interest at a low elevation and rise toward those features that are best seen from below or in silhouette against the sky.

12.2.3 Design of Profile Grade Lines

12.2.3.1 General

The profile grade line of a highway typically has the greatest impact on a facility's cost, aesthetics, safety and operation. The profile is a series of tangent lines connected by parabolic vertical curves.

The designer must carefully evaluate many factors when establishing the profile grade line of a highway. These include:

- maximum and minimum gradients;
- sight distance criteria;
- earthwork balance;
- bridges and drainage structures;
- high-water levels (flood frequency);
- drainage considerations;
- water table elevations;
- intersections and interchanges;
- railroad/highway crossings;
- types of soil;
- adjacent land use and values;
- highway safety;
- coordination with other geometric features (e.g., the cross section);
- topography/terrain;
- truck performance;
- available right of way and associated costs;
- type and location of utilities;
- urban/rural location;
- aesthetics/landscaping;
- construction costs;
- environmental impacts;
- driver expectations;
- airport flight paths (e.g., grades and lighting); and
- pedestrian and disabled accessibility.

The following Sections discuss the establishment of the profile grade line in more detail.

12.2.3.2 Profile Grade Line Locations

The location of the profile grade line on the roadway cross section varies according to the highway and median type. The profile grade line locations are shown in the typical cross section figures provided in [Chapters 19 through 22](#). The profile grade line should generally coincide with the axis of rotation for superelevation. The recommended profile grade line for various typical sections are as follows:

1. Flush Medians. The profile grade line should coincide with the highway centerline.
2. Depressed Medians. The profile grade lines should be located at the point of grade on each of the traveled ways. The grade on each of the traveled ways may be independent of each other when the median width varies or on freeways

where the terrain is conducive to independent roadway designs. Separate horizontal alignments may need to be developed as well.

3. Ramps/Freeway to Freeway Connections. The profile grade line is normally established on the survey line but may be positioned at either edge of the ramp traveled way or the centerline on multilane ramps.

12.2.3.3 Factors Affecting the Design of Profile Grade Lines

Evaluate the following factors when developing a profile grade line on a project:

1. Vertical Curves. Long vertical curves on urban streets are generally impractical. The designer will typically need to lay out the profile grade line to meet existing conditions. Therefore, the minimum vertical curve lengths generally are provided on urban streets. Where practical, locate VPI's at or near the centerlines of cross streets. For flat urban areas where the algebraic difference in grades is less than 1 percent, use the minimum length of sag or crest curve as discussed in [Sections 12.5.1](#) and [12.5.2](#) (i.e., $L = 3V$). At signalized and stop-controlled intersections, some flattening of the approaches also may be required for better traffic operations.
2. Grade Differential. Avoid appreciable grade differentials between roadways on divided facilities, for either interim or ultimate designs, in the vicinity of intersections. Confusion and/or wrong-way movements could result for traffic entering from the crossroad if the pavement surface of the roadway on the opposite side is obscured from view.
3. Soils. The type of material encountered often influences the profile grade line at certain locations. For example, if rock is encountered, it may be more economical to raise the grade line and reduce the rock excavation. Soils that are unsatisfactory for embankment or cause a stability problem in cut areas may also be determining factors in establishing the profile grade line. The designer should coordinate the development of the profile grade line with the Geotechnical Section.
4. Drainage. Proper placement of the pavement structure above the surrounding topography can significantly enhance the life and serviceability of the roadway. Consequently, the profile grade line should be compatible with the roadway drainage design. Consider the following:
 - a. Culverts. The roadway elevation should meet the Department criteria for minimum cover at culverts and minimum freeboard above the headwater level at culverts. See the *SCDOT Requirements for Hydraulic Design Studies* for more information on the hydraulic and structural design of culverts.

- b. Coordination with Geometrics. The profile grade line must reflect compatibility between drainage design and roadway geometrics. Items to consider include the design of sag and crest vertical curves, spacing of inlets on curbed facilities, impacts on adjacent properties, superelevated curves, intersection design elements and interchange design elements.
 - c. Curb and Gutters. Curbs and gutters may complicate the layout of the profile grade line. Take special care to avoid flat spots where water may pond, especially through radius returns. [Section 12.3](#) provides the minimum gradients for curbed streets. In very flat areas, the profile grade line may be rolled up and down at 0.3 to 0.5 percent to provide the necessary drainage. At intersections, the surface drainage preferably should be intercepted upstream of an intersection. Insure adequate drainage is provided behind curbs.
5. Erosion Control. To minimize erosion, consider the following relative to the profile grade line:
- Minimize the number of deep cuts and high-fill sections.
 - Conform the highway to the contour and drainage patterns of the area.
 - Use natural land barriers and contours to channelize runoff and confine erosion and sedimentation.
 - Minimize the amount of disturbance.
 - Preserve and use existing vegetation.
 - Reduce the slope length by benching and insure that erosion is confined to the right of way and does not deposit sediment or erode adjacent lands.
 - Avoid locations having high erosion potential (e.g., loose soils).
 - Avoid cut or fill sections in seepage areas.
6. Earthwork Balance. Where practical and consistent with other project objectives, design the profile grade line to provide a balance of earthwork. However, this should not be achieved at the expense of smooth grade lines, aesthetics or sight distance requirements at vertical curves, or when there is excessive land acquisition costs. Ultimately, a project-by-project assessment will determine whether a project will be borrow, waste or balanced.

Balancing earthwork is typically impractical in urban areas. An excess of excavation is preferable to the need for borrow, due to the generally higher cost of borrow in urban areas.

7. Bridges. Carefully coordinate the design of the profile grade line with any bridges within the project limits. The following will apply:
 - a. Vertical Clearances. The criteria in [Chapters 19 through 22](#) must be met. When laying the preliminary grade line, an important element in determining the available vertical clearance is the assumed structure depth. This will be based on the structure type, span lengths and depth/span ratio. The designer should coordinate with the Bridge Design Section to determine the roadway and bridge grade lines.
 - b. Bridges Over Waterways. Where a proposed facility will cross a body of water, the bridge elevation must be consistent with the necessary waterway opening to meet the Department's hydraulic requirements. The designer must coordinate with the Hydraulic Engineering and Bridge Design Sections to determine the appropriate bridge elevation. Also, see [Section 12.6](#).
 - c. Railroad Bridges. Any proposed highway over a railroad must meet the applicable criteria (e.g., vertical clearances, structure type and depth). The designer should contact the Utilities Office for more information.
 - d. Highway Under Bridge. When practical, the low point of a roadway sag vertical curve should not be within the shadow of the bridge. This will help minimize ice accumulations, and it will reduce the ponding of water beneath the bridge. To achieve these objectives, the low point of roadway sag should be approximately 100 feet or more from the side of the bridge.
 - e. High Embankments. Consider the impact that high embankments will have on bridges and culverts. High embankments will increase the span length thus increasing structure costs, and also increase the length and type of culvert to carry the overburden.
 - f. Low Point. It is desirable to locate the low point of a sag vertical curve off the bridge deck.
8. Ties With Existing Highways. A smooth transition is needed between the proposed profile grade line of the project and the existing grade line of an adjoining highway section. Consider existing grade lines for a sufficient distance beyond the beginning and end of a project to insure adequate sight distances. Connections should be made which are compatible with the design speed of the new project and which can be used if the adjoining road section is reconstructed.
9. Underground Utilities. On existing streets, insure that any change in the profile grade line will still provide the minimum coverage for utilities. For additional guidance on minimum utility clearances, see SCDOT publication *A Policy for Accommodating Utilities on Highway Rights of Way*.

10. Right of Way. Careful consideration must be given when substantially lowering or raising the profile grade line. This will often result in more right of way impacts (e.g., steeper driveways, removing parking, reducing front lawns, adding retaining walls). Where roadside development is extensive, the cross section design of a curb and gutter street is important. Insure profiles for existing driveways are acceptable.

12.3 GRADES

12.3.1 Maximum Grades

Chapters 19 through 22 present the Department's criteria for maximum grades based on functional classification, urban/rural location, type of terrain, design speed and project scope of work. Wherever practical, use grades flatter than the maximum.

12.3.2 Minimum Grades

The following provides the Department's criteria for minimum grades:

1. Roadways without Curbs. It is desirable to provide a minimum longitudinal gradient of approximately 0.5 percent. This allows for the possibility of alterations to the original pavement. Longitudinal gradients of 0 percent may be acceptable on some pavements that have adequate cross slopes. In these cases, check the flow lines of the outside ditches to insure adequate drainage.
2. Roadways with Curbs/Valley Gutters. The median edge or centerline profile of streets with curb and gutter desirably should have a minimum longitudinal gradient of 0.5 percent. Where the adjacent development or flatter terrain precludes the use of a profile with a 0.5 percent grade, provide a minimum longitudinal gradient of at least 0.3 percent. Because surface drainage is retained within the roadway, the longitudinal gradient must be steeper on curb sections to avoid ponding of water on the roadway surface. Where additional catch basins are not feasible, then trench drains may be installed in the gutters to enhance the drainage of the roadway. Trench drains in gutters will reduce potential ponding in the gutter area caused by flat or near flat grades occurring in areas being superelevated and in vertical curves. For additional information on trench drains, see [Chapter 29](#).

12.3.3 Critical Length of Grade

The critical length of grade is the maximum length of a specific upgrade on which a truck can operate without an unreasonable reduction in speed. The highway gradient in combination with the length of the grade will determine the truck speed reduction on upgrades. For additional guidance, see the *Highway Capacity Manual* and the *AASHTO A Policy on Geometric Design of Highways and Streets*.

The following will apply to the critical length of grade:

1. Design Vehicle. [Figure 12.3A](#) presents the critical length of grade for a 200-pound/horsepower truck. This vehicle applies to all truck routes in South Carolina. However, in some instances the recreational vehicle may be used as the design vehicle. [Figure 12.3B](#) presents the critical length of grade for a recreational vehicle.
2. Criteria. [Figures 12.3A](#) and [12.3B](#) provide the critical lengths of grade for a given percent grade and acceptable speed reduction. Although [Figure 12.3A](#) is based on an initial truck speed of 70 miles per hour and [Figure 12.3B](#) on an initial recreational vehicle speed of 55 miles per hour, they apply to any design or posted speed. For design purposes, use the 10-mile-per-hour speed reduction curve in the figures to determine if the critical length of grade is exceeded.
3. Momentum Grades. Where an upgrade is preceded by a downgrade, trucks will often increase their speed to ascend the upgrade. A speed increase of 5 miles per hour on moderate downgrades (3 percent to 5 percent) and 10 miles per hour on steeper downgrades (6 percent to 8 percent) of sufficient length are reasonable adjustments to the initial speed. This assumption allows the use of a higher speed reduction curve in [Figure 12.3A](#). However, the designer should also consider that these speed increases may not always be attainable. If traffic volumes are sufficiently high, a truck may be behind another vehicle when descending the momentum grade thereby restricting the increase in speed. Therefore, only consider these increases in speed if the highway has a level of service B or better.
4. Measurement. Vertical curves are part of the length of grade. [Figure 12.3C](#) illustrates how to measure the length of grade to determine the critical length of grade using [Figure 12.3A](#).
5. Application. If the critical length of grade is exceeded, either flatten the grade, if practical, or evaluate the need for a truck-climbing lane; see [Section 12.4](#).
6. Highway Types. The critical-length-of-grade criteria apply equally to two-lane or multilane highways and apply equally to urban and rural facilities.
7. Example Problems. [Examples 12.3\(1\)](#) and [12.3\(2\)](#) illustrate the use of [Figure 12.3A](#) to determine the critical length of grade. [Example 12.3\(3\)](#) illustrates the use of [Figures 12.3A](#) and [12.3C](#).

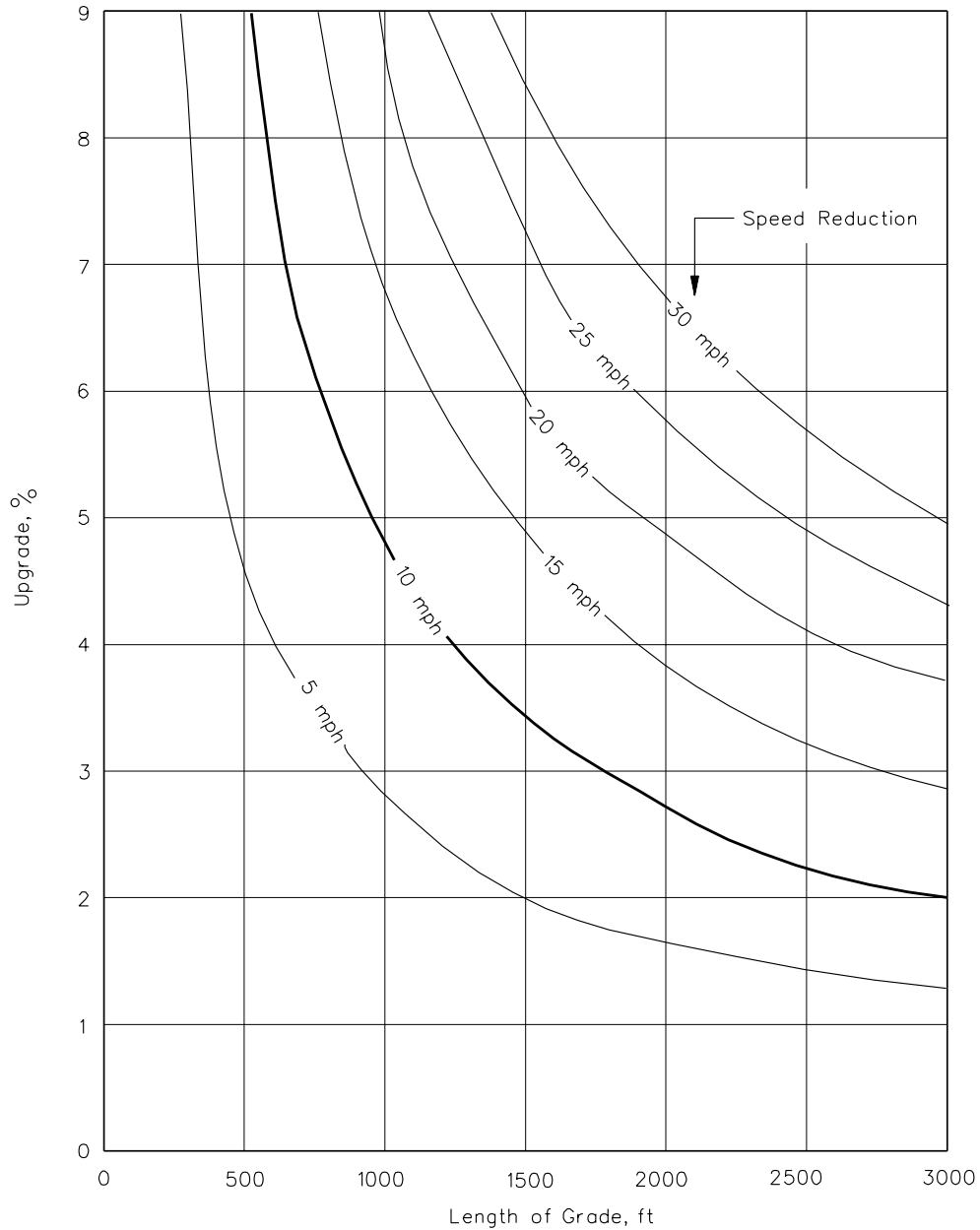

Notes:

1. Typically, the 10 mile-per-hour curve will be used.
2. See examples in this Section for use of figure.
3. Figure is based on a truck with initial speed of 70 miles per hour. However, it may be used for any design or posted speed.

**CRITICAL LENGTH OF GRADE
(200 lb/hp Truck)**

Figure 12.3A

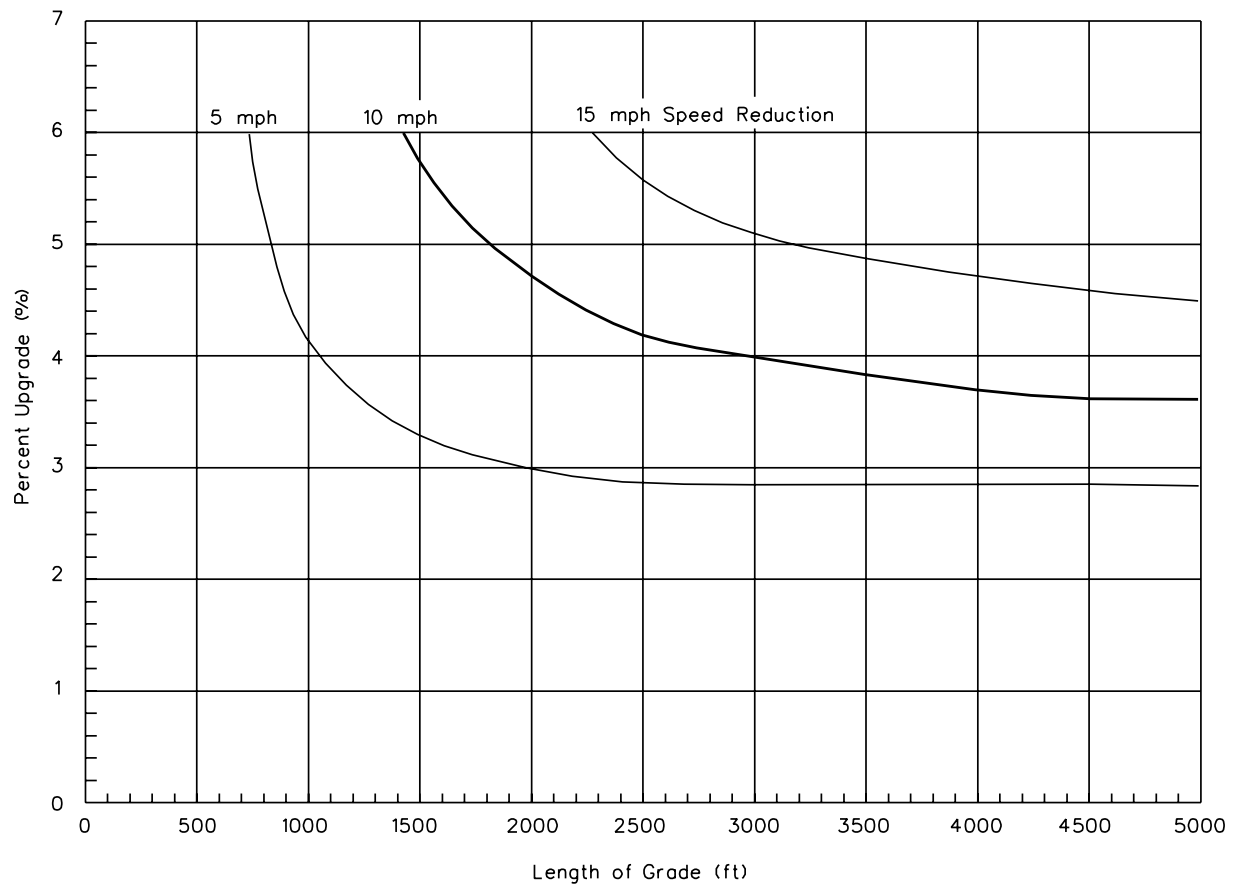

Notes:

1. Typically, the 10 mile-per-hour curve will be used.
2. Figure is based on a recreation vehicle with initial speed of 55 miles per hour. However, it may be used for any design or posted speed.

**CRITICAL LENGTH OF GRADE
(Recreation Vehicle)**

Figure 12.3B

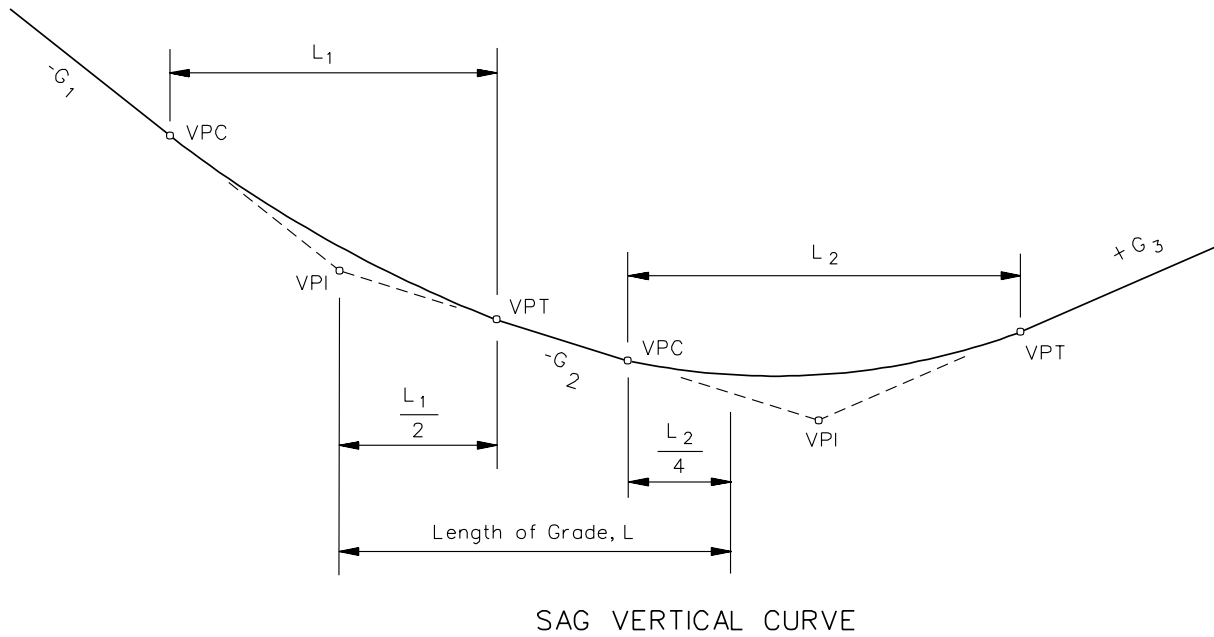
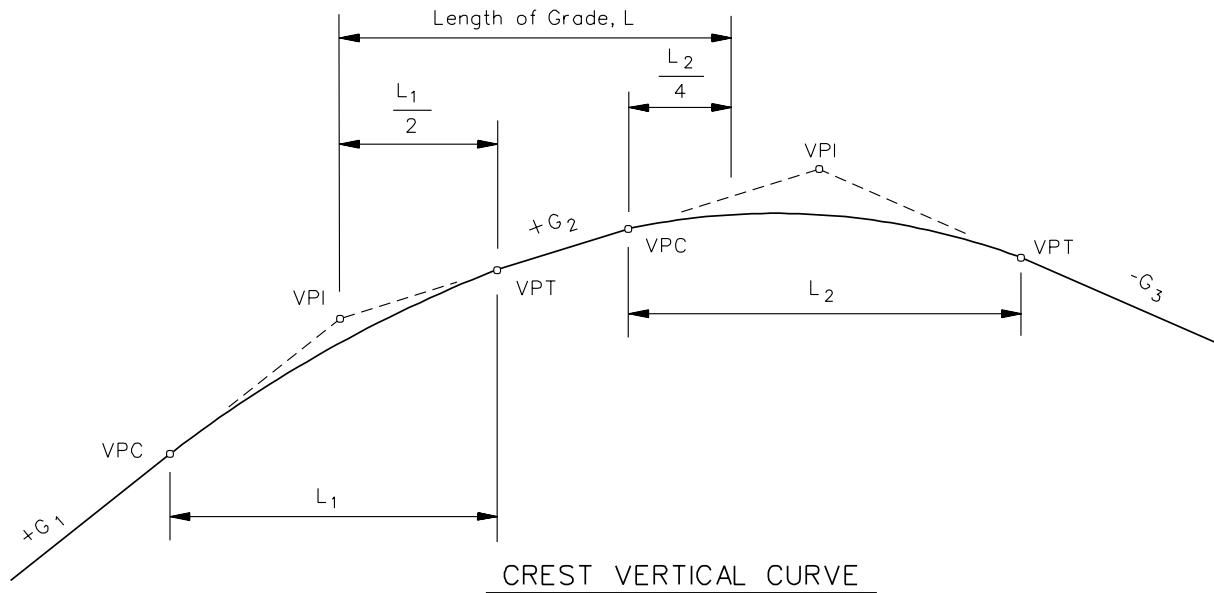

Notes:

1. For vertical curves where the two tangent grades are in the same direction (both upgrades or both downgrades), 50 percent of the curve length will be part of the length of grade.
2. For vertical curves where the two tangent grades are in opposite directions (one grade up and one grade down), 25 percent of the curve length will be part of the length of grade.
3. The above diagram is included for illustrative purposes only. Broken back vertical curves are to be avoided where practical.

MEASUREMENT FOR LENGTH OF GRADE

Figure 12.3C

* * * * *

Example 12.3(1)

Given: Level Approach
G = + 4 percent
L = 1500 feet (length of grade)
Rural Principal Arterial

Problem: Determine if the critical length of grade is exceeded.

Solution: [Figure 12.3A](#) yields a critical length of grade of 1250 feet for a 10 mile-per-hour speed reduction. The length of grade (L) exceeds this value. Therefore, flatten the grade, if practical, or evaluate the need for a truck-climbing lane.

Example 12.3(2)

Given: Level Approach
G₁ = + 4.5 percent
L₁ = 500 feet
G₂ = + 2 percent
L₂ = 700 feet
Rural Collector with a significant number of heavy trucks

Problem: Determine if the critical length of grade is exceeded for the combination of grades G₁ and G₂.

Solution: From [Figure 12.3A](#), G₁ yields a truck speed reduction of approximately 4 miles per hour. G₂ yields a speed reduction of approximately 3 miles per hour. The total of 7 miles per hour is less than the maximum 10 mile-per-hour speed reduction. Therefore, the critical length of grade is not exceeded.

Example 12.3(3)

Given: [Figure 12.3D](#) illustrates the vertical alignment on a low-volume, two-lane rural collector highway with sufficient number of large trucks to govern the design.

Problem: Determine if the critical length of grade is exceeded for G₂ or for the combination upgrade G₃ and G₄.

Solution: Use the following steps:

Step 1. Determine the length of grade using the criteria in [Figure 12.3C](#). For this example, these are calculated as follows:

$$L_2 = \frac{1000}{4} + 600 + \frac{800}{4} = 1050 \text{ feet}$$

$$L_3 = \frac{800}{4} + 700 + \frac{400}{2} = 1100 \text{ feet}$$

$$L_4 = \frac{400}{2} + 300 + \frac{600}{4} = 650 \text{ feet}$$

Step 2. Determine the critical length of grade in both directions. For trucks, use [Figure 12.3A](#) to determine the critical length of grade.

- a. For trucks traveling left to right, enter into [Figure 12.3A](#) the value for G_3 (3.5 percent) and $L_3 = 1100$ feet. The speed reduction is approximately 7.5 miles per hour. For G_4 (2 percent) and $L_4 = 650$ feet, the speed reduction is approximately 3.5 miles per hour. The total speed reduction on the combination upgrade G_3 and G_4 is approximately 11 miles per hour. This exceeds the maximum 10 mile-per-hour speed reduction. However, on low-volume roads, one can assume a 5 mile-per-hour increase in truck speed for the 3 percent “momentum” grade (G_2), which precedes G_3 . Therefore, a speed reduction may be as high as 15 miles per hour before concluding that the combination grade exceeds the critical length of grade. Assuming the benefits of the momentum grade, this leads to the conclusion that the critical length of grade is not exceeded.
- b. For trucks traveling in the opposite direction, on [Figure 12.3A](#), enter in the value for G_2 (3 percent) and determine the critical length of grade for the 10 mile-per-hour speed reduction (i.e., 1700 feet). Because L_2 is less than 1700 feet (i.e., 1050 feet), the critical length of grade for this direction is not exceeded.

* * * * *

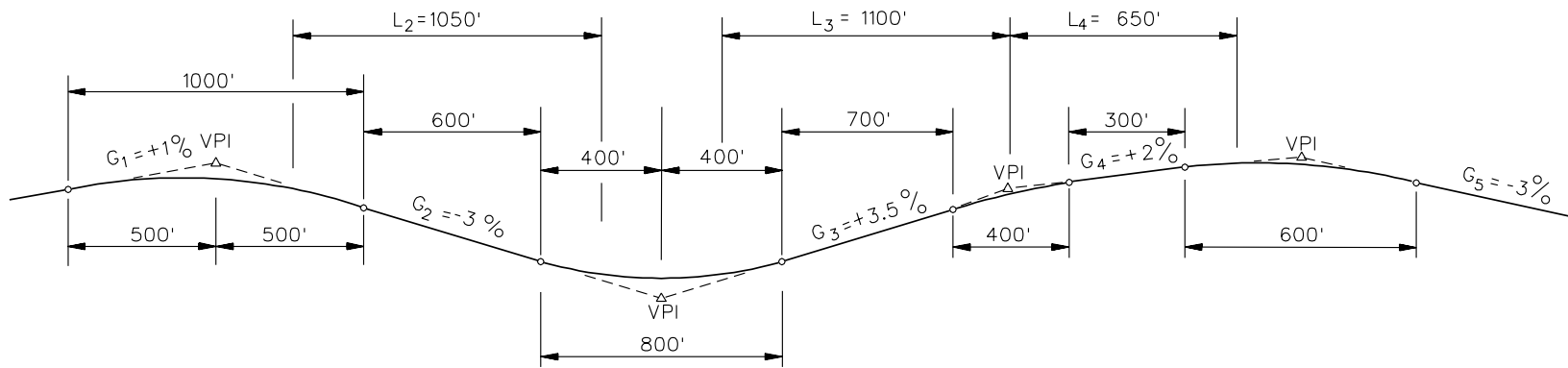

CRITICAL LENGTH OF GRADE CALCULATIONS
(Example 12.3(3))
Figure 12.3D

12.4 TRUCK-CLIMBING LANES

12.4.1 Guidelines

A truck-climbing lane may be necessary to allow a specific upgrade to operate at an acceptable level of service. The following criteria apply.

12.4.1.1 Two-Lane Highways

On a two-lane, two-way highway, a truck-climbing lane should be considered if the following conditions are satisfied:

- the traffic volume exceeds 200 vehicles per hour during the design hour; and
- the heavy-vehicle volume (i.e., trucks, buses, and recreational vehicles) exceeds 20 vehicles/hour during the design hour; and
- the construction costs and the construction impacts (e.g., environmental, right of way) are considered reasonable; and
- one of the following conditions exists:
 - + the critical length of grade is exceeded for the 10 mile-per-hour speed reduction curve (see [Figure 12.3A](#) or [Figure 12.3B](#)); or
 - + the level of service (LOS) on the upgrade is E or F; or
 - + there is a reduction of two or more LOS when moving from the approach segment to the grade.

In addition, safety considerations may justify the addition of a climbing lane regardless of grade or traffic volumes.

12.4.1.2 Multilane Highways

A truck-climbing lane may be considered on a multilane highway if the following conditions are satisfied:

- the directional service volume exceeds 1000 vehicles per hour; and
- the construction costs and the construction impacts (e.g., environmental, right of way) are considered reasonable; and
- one of the following conditions exists:

- + the critical length of grade is exceeded for the 10 mile-per-hour speed reduction curve (see [Figure 12.3A](#) or [Figure 12.3B](#)); or
- + the LOS on the upgrade is E or F; or
- + there is a reduction of one or more LOS when moving from the approach segment to the grade.

In addition, safety considerations may justify the addition of a climbing lane regardless of grade or traffic volumes.

12.4.2 Capacity Analysis

See the *Highway Capacity Manual* for details on how to prepare a capacity analysis for climbing lanes on two-lane and multilane highways.

12.4.3 Design Guidelines

[Figure 12.4A](#) summarizes the design criteria for a truck-climbing lane. Also consider the following:

1. Design Speed. For entering speeds equal to or greater than 70 miles per hour, use 70 miles per hour for the truck design speed. For speeds less than 70 miles per hour, use the roadway design speed or the posted speed limit whichever is less. Under restricted conditions, the designer may want to consider the effect a momentum grade will have on the entering speed. See [Section 12.3.3](#) for additional information on momentum grades. However, the maximum speed will be 70 miles per hour.
2. Superelevation. For horizontal curves, superelevate the truck-climbing lane at the same rate as the adjacent travel lane.
3. Performance Curves. [Figure 12.4B](#) presents the deceleration and acceleration rates for a 200-pound/horsepower truck.
4. End of Full-Width Lane. In addition to the criteria in [Figure 12.4A](#), insure there is sufficient sight distance available to the point where the truck, RV or bus will begin to merge into the through travel lane. At a minimum, this will be stopping sight distance. Desirably, the driver should have decision sight distance available to the end of the taper. See [Section 10.3](#) for the decision sight distance values.

DESIGN ELEMENT	DESIRABLE	MINIMUM
Lane Width	12 ft	Freeway: 12 ft Other Facilities: 11 ft
Shoulder Width	Same as Approach Roadway	6 ft
Cross Slope on Tangent	2%	2%
Beginning of Full-Width Lane ⁽¹⁾	Location where the truck speed has been reduced to 10 mph below the posted speed limit.	Location where the truck speed has been reduced to 45 mph.
End of Full-Width Lane ⁽²⁾	Location where truck has reached highway posted speed or 55 mph whichever is less.	Location where truck has reached 10 mph below highway posted speed limit.
Entering Taper	300 ft	300 ft
Exiting Taper	600 ft	50:1
Minimum Full-Width Length	1000 ft or greater	1000 ft

Notes:

1. Use [Figure 12.4B](#) to determine truck deceleration rates. In determining the applicable truck speed, the designer may consider the effect of momentum grades.
2. Use [Figure 12.4B](#) to determine truck acceleration rates. Also, see Comment 4 in [Section 12.4.3](#).

DESIGN CRITERIA FOR TRUCK-CLIMBING LANES

Figure 12.4A

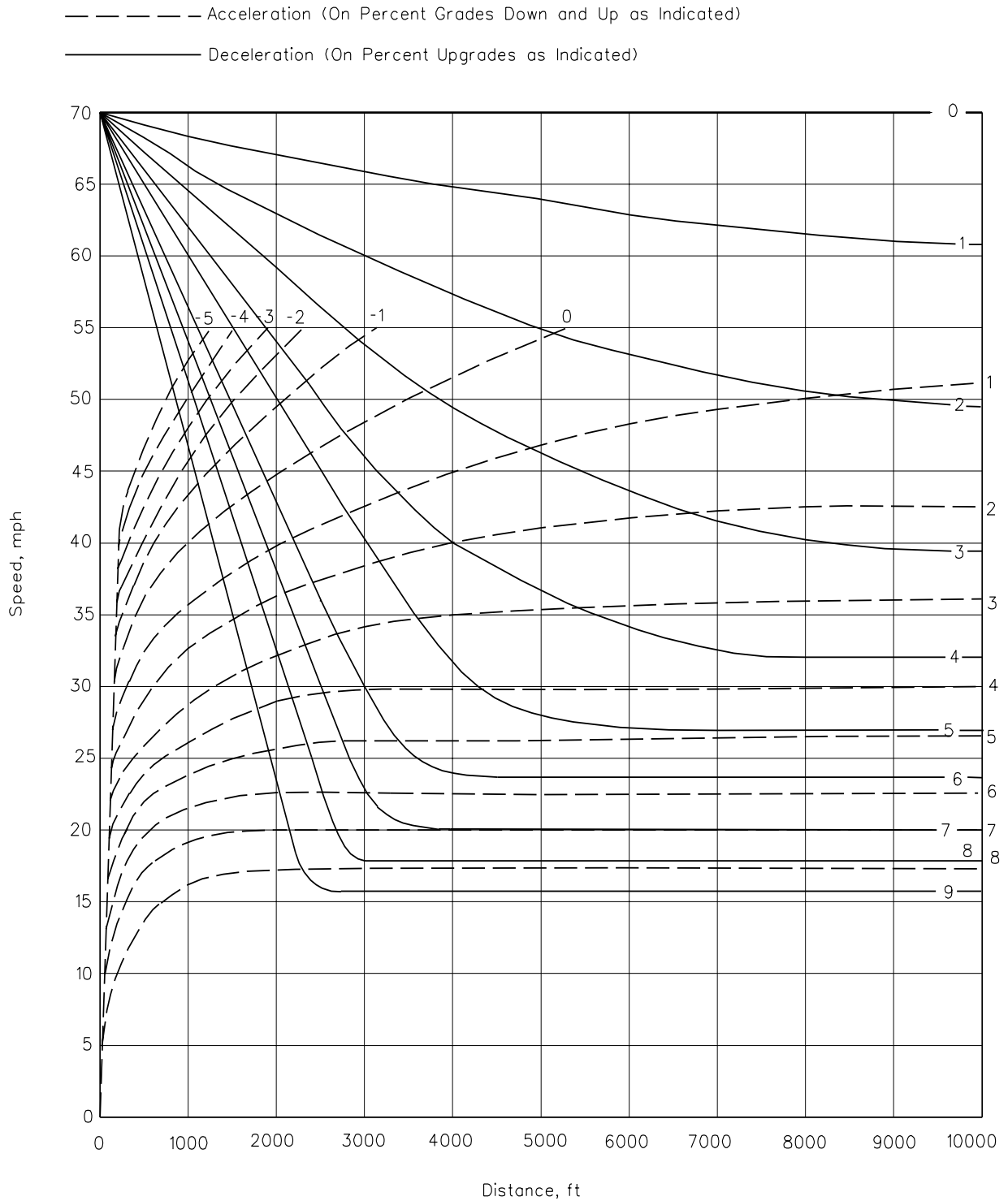

Note: For entering speeds equal to or greater than 70 miles per hour, use an initial speed of 70 miles per hour. For speeds less than 70 miles per hour, use the design speed or posted speed limit as the initial speed.

**PERFORMANCE CURVES FOR TRUCKS
 (200 lb/hp)
 Figure 12.4B**

The full-lane width should be extended beyond the crest vertical curve and not ended just beyond the crest vertical curve. Also, desirably the full-lane width should not end on a horizontal curve.

5. Signing and Pavement Markings. Contact the Traffic Engineering Division for guidance on signing and pavement markings for climbing lanes.

12.4.4 Downgrades

Truck lanes on downgrades are typically not considered. However, steep downhill grades may also have a detrimental effect on the capacity and safety of facilities with high-traffic volumes and numerous heavy trucks. Although specific criteria have not been established for these conditions, trucks descending steep downgrades in low gear may produce nearly as great an effect on operations as an equivalent upgrade. The need for a truck lane for downhill traffic will be considered on a site-by-site basis.

12.4.5 Truck Speed Profile

For highways with a single grade, the critical length of grade and deceleration and acceleration rates can be directly determined from [Figure 12.4B](#). However, it is often necessary to find the impact of a series of significant grades in succession. If several different grades are present, then a speed profile may need to be developed.

The following example illustrates how to construct a truck speed profile and how to use [Figure 12.4B](#).

Example 12.4(1)

Given: Level Approach
 $G_1 = +3$ percent for 800 feet (VPI to VPI)
 $G_2 = +5$ percent for 3200 feet (VPI to VPI)
 $G_3 = -2$ percent beyond the composite upgrade (G_1 and G_2)
 $V = 60$ mile-per-hour design speed with a 55 mile-per-hour posted speed limit
Rural Principal Arterial

Problem: Using the criteria in [Figure 12.4A](#) and [Figure 12.4B](#), construct a truck speed profile and determine the beginning and ending points of the full-width climbing lane.

Solution: The following steps apply:

Step 1: Determine the truck speed on G_1 using [Figure 12.4B](#) and plot the truck speed at 200-foot increments in [Figure 12.4C](#). Assume an initial truck speed of 55 miles per hour. Move horizontally along the 55 mile-per-hour line to the 3 percent deceleration curve. This is approximately 2800 feet along the horizontal axis. This is the starting point for G_1 .

Distance From VPI ₁ (feet)	Horizontal Distance on Figure 12.4B (feet)	Truck Speed (miles per hour)	Comments
0	2800	55	VPI ₁
200	3000	54	
400	3200	53	
600	3400	52	
800	3600	51	VPI ₂

Step 2: Determine the truck speed on G_2 using [Figure 12.4B](#) and plot the truck speed at 200-foot increments in [Figure 12.4C](#). From Step 1, the initial speed on G_2 is the final speed from G_1 (i.e., 51 miles per hour). Move right horizontally along the 51 mile-per-hour line to the 5 percent deceleration curve. This is approximately 1900 feet along the horizontal axis. This is the starting point for G_2 .

Figure 12.4C Distance From VPI ₁ (feet)	Horizontal Distance on Figure 12.4B (feet)	Truck Speed (miles per hour)	Comments
800	1900	51	VPI ₂
1000	2100	49	
1200	2300	47	
1400	2500	45	
1600	2700	43	
1800	2900	41	
2000	3100	39	
2200	3300	37	
2400	3500	35	
2600	3700	33	
2800	3900	32	
3000	4100	31	
3200	4300	30	
3400	4500	29	
3600	4700	29	
3800	4900	28	
4000	5100	28	VPI ₃

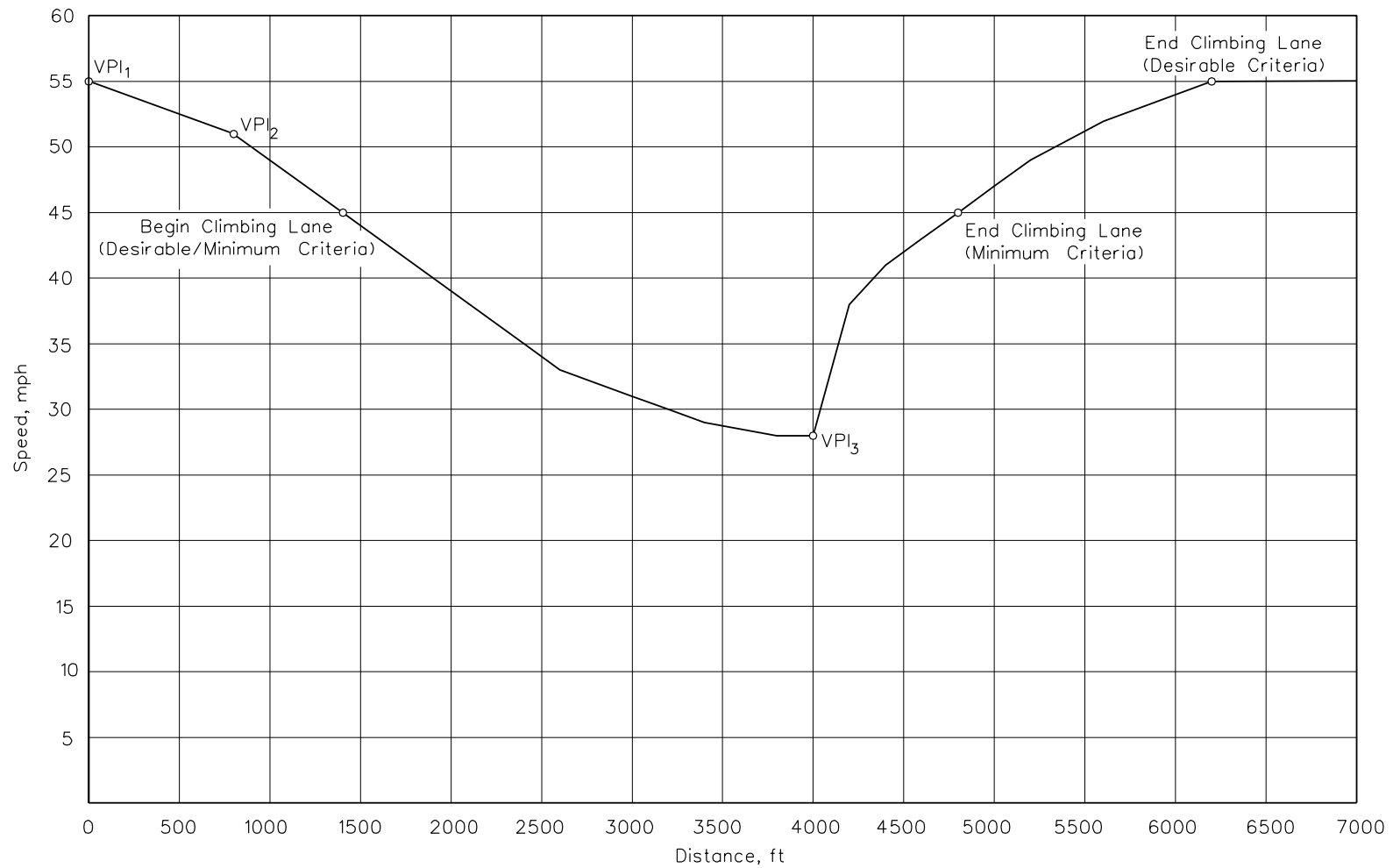

TRUCK SPEED PROFILE
(Example 12.4(1))
Figure 12.4C

Step 3: Determine the truck speed on G_3 using [Figure 12.4B](#) until the truck has fully accelerated to 55 miles per hour and plot the truck speed at 200-foot increments in [Figure 12.4C](#). The truck will have a speed of 28 miles per hour as it enters the 2 percent downgrade at VPI_3 . Read into [Figure 12.4B](#) at the 28 mile-per-hour point on the vertical axis and move over horizontally to the -2 percent line. This is approximately 150 feet along the horizontal axis. This is the starting point for G_3 .

Figure 12.4C Distance From VPI_1 (feet)	Horizontal Distance on Figure 12.4B (feet)	Truck Speed (miles per hour)	Comments
4000	150	28	VPI_3
4200	350	38	
4400	550	41	
4600	750	43	
4800	950	45	
5000	1150	47	
5200	1350	49	
5400	1550	50	
5600	1750	52	
5800	1950	53	
6000	2150	54	
6200	2350	55	

Step 4: Determine the beginning and end of the full-width climbing lane. From [Figure 12.4A](#), the desirable and minimum beginning of the full-width lane will be where the truck has reached a speed of 45 miles per hour (10 miles per hour below the posted speed). This point occurs 1400 feet beyond VPI_1 .

For ending the full-width climbing lane, the desirable criteria from [Figure 12.4A](#) is where the truck speed has reached the posted speed limit (55 miles per hour) or 6200 feet beyond the VPI_1 . The minimum criterion is where the truck has reached a speed of 45 miles per hour (10 miles per hour below the posted speed). This occurs at 4800 feet beyond VPI_1 .

12.5 VERTICAL CURVES

12.5.1 Crest Vertical Curves

12.5.1.1 Equations

Crest vertical curves are in the shape of a parabola. The basic equations for determining the minimum length of a crest vertical curve are:

$$L = \frac{AS^2}{200(\sqrt{h_1} + \sqrt{h_2})^2} \quad (\text{Equation 12.5.1})$$

$$K = \frac{S^2}{200(\sqrt{h_1} + \sqrt{h_2})^2} \quad (\text{Equation 12.5.2})$$

$$L = KA \quad (\text{Equation 12.5.3})$$

where:

- L = length of vertical curve, feet
- A = absolute value of the algebraic difference between the two tangent grades, percent
- S = sight distance, feet
- h_1 = height of eye above road surface, feet
- h_2 = height of object above road surface, feet
- K = horizontal distance needed to produce a 1 percent change in gradient

The length of a crest vertical curve will depend upon “A” for the specific curve and upon the selected sight distance, height of eye and height of object. Equation 12.5.1 and the resultant values of K are predicated on the sight distance being less than the length of vertical curve. However, these values can also be used, without significant error, where the sight distance is greater than the length of vertical curve. The following Sections discuss the selection of K-values. For design purposes, round the calculated length up to the next highest 50-foot increment.

12.5.1.2 Stopping Sight Distance

The principal control in the design of crest vertical curves is to insure that minimum stopping sight distance (SSD) is available throughout the vertical curve. The following discusses the application of K-values for various operational conditions:

1. Passenger Cars (Level Grade). [Figure 12.5A](#) presents K-values for passenger cars on a level grade. Level conditions are assumed where the grade on the far side of the vertical curve is less than 3 percent. The minimum values are calculated by assuming $h_1 = 3.5$ feet, $h_2 = 2$ feet and $S = SSD$ in the basic equation for crest vertical curves (Equation 12.5.1).
2. Passenger Cars (Grade Adjusted). For crest vertical curves, consider grade adjustments where the downgrade is 3 percent or greater. However, every effort should be made to provide stopping sight distances greater than the design values in [Figure 10.1A](#) where horizontal sight restrictions occur on downgrades, even when the horizontal sight obstruction is a cut slope. No adjustment is necessary for grades less than 3 percent. Use [Equation 12.5.1](#) and the grade adjusted SSD's from [Figure 10.1C](#) to determine the length of vertical curve.
3. Minimum Length. The minimum length of a crest vertical curve in feet should be $3V$, where V is the design speed in miles per hour.
4. Minimum Values. Designs should be made to values as high as are commensurate with conditions. Minimum values should be used only where the use of higher value will result in unacceptable social, economic or environmental consequences.

12.5.1.3 Passing Sight Distance

At some locations, it is desirable to provide passing sight distance in the design of crest vertical curves. [Section 10.2](#) discusses the application and design values for passing sight distance on two-lane, two-way highways. Passing sight distance values are used as the "S" value in the basic equation for crest vertical curves ([Equation 12.5.1](#)). In addition, the following will apply:

1. Height of Eye (h_1). For passenger cars, $h_1 = 3.5$ feet.
2. Height of Object (h_2). Passing sight distance is predicated upon the passing driver being able to see a sufficient portion of the top of the oncoming car. Therefore, $h_2 = 3.5$ feet.
3. K-Values. [Figure 12.5B](#) presents the K-values for passenger cars using the passing sight distances presented in [Figure 10.2B](#).

Design Speed (miles per hour)	Stopping ¹ Sight Distance (feet)	Rate of Vertical Curvature, K-Value ²	
		Minimum ³	
		Calculated	Design
15	80	3.0	3
20	115	6.1	7
25	155	11.1	12
30	200	18.5	19
35	250	29.0	29
40	305	43.1	44
45	360	60.1	61
50	425	83.7	84
55	495	113.5	114
60	570	150.6	151
65	645	192.8	193
70	730	246.9	247
75	820	311.6	312
80	910	383.7	384

Notes:

1. Stopping sight distances (SSD) are from [Figure 10.1A](#).
2. Maximum K-value for drainage on curbed roadways is 167; see [Section 12.5.1.4](#).
3. (Minimum) $K = \frac{SSD^2}{2158}$, where: $h_1 = 3.5$ feet, $h_2 = 2$ feet

**K-VALUES FOR CREST VERTICAL CURVES — STOPPING SIGHT DISTANCES
(Passenger Cars — Level Grades)**

Figure 12.5A

Design Speed (miles per hour)	Passing Sight Distance ¹ (feet)	Rate of Vertical Curvature ² , K-Value
20	710	180
25	900	289
30	1090	424
35	1280	585
40	1470	772
45	1625	943
50	1835	1203
55	1985	1407
60	2135	1628
65	2285	1865
70	2480	2197
75	2580	2377
80	2680	2565

Notes:

1. Design passing sight distances (PSD) are from [Section 10.2](#).

2. $K = \frac{PSD^2}{2800}$, where: $h_1 = 3.5$ feet, $h_2 = 3.5$ feet

**K-VALUES FOR CREST VERTICAL CURVES — PASSING SIGHT DISTANCES
(Passenger Cars)**

Figure 12.5B

12.5.1.4 Drainage

Proper drainage must be considered in the design of crest vertical curves. Typically, drainage problems will not be experienced if the vertical curvature is sharp enough so that a minimum longitudinal gradient of at least 0.3 percent is reached at a point about 50 feet from either side of the apex. To insure that this objective is achieved, determine the length of the crest vertical curve assuming a K-value of 167 or less. Where the maximum drainage K-value is exceeded, carefully evaluate the drainage design near the apex. With the use of proper cross slopes, drainage generally should not be a problem on crest vertical curves.

12.5.2 Sag Vertical Curves

12.5.2.1 Equations

Sag vertical curves are in the shape of a parabola. Typically, they are designed to allow the vehicular headlights to illuminate the roadway surface (i.e., the height of object = 0.0 feet for a given distance "S." The light beam from the headlights is assumed to have a 1° upward divergence from the longitudinal axis of the vehicle. These assumptions yield the following basic equations for determining the minimum length of sag vertical curves:

$$L = \frac{AS^2}{200[h_3 + S(\tan 1^\circ)]} = \frac{AS^2}{200h_3 + 3.5S} \quad (\text{Equation 12.5.4})$$

$$K = \frac{S^2}{200h_3 + 3.5S} \quad (\text{Equation 12.5.5})$$

$$L = KA \quad (\text{Equation 12.5.6})$$

where:

L = length of vertical curve, feet

A = absolute value of the algebraic difference between the two tangent grades, percent

S = sight distance, feet

h_3 = height of headlights above pavement surface, feet

K = horizontal distance needed to produce a 1 percent change in gradient

The length of a sag vertical curve will depend upon “A” for the specific curve and upon the selected sight distance and headlight height. [Equation 12.5.4](#) and the resultant values of K are predicated on the sight distance being less than the length of vertical curve. However, these values can also be used, without significant error, where the sight distance is greater than the length of vertical curve. The following Sections discuss the selection of K-values.

12.5.2.2 Stopping Sight Distance

The principal control in the design of sag vertical curves is to insure minimum stopping sight distance (SSD) is available for headlight illumination throughout the sag vertical curve. The following discusses the application of K-values for various operational conditions:

1. Passenger Cars (Level Grade). [Figure 12.5C](#) presents K-values for passenger cars. These are calculated by assuming $h_3 = 2$ feet and $S = SSD$ in the basic equation for sag vertical curves ([Equation 12.5.4](#)). The minimum values represent the lowest acceptable sight distance on a facility. Use longer than the minimum lengths of curves to provide a more aesthetically pleasing design.
2. Passenger Cars (Grade Adjusted). For sag vertical curves, consider grade adjustments where the downgrade is 3 percent or greater. No adjustment is necessary for grades less than 3 percent. However, every effort should be made to provide stopping sight distances greater than the design values in [Figure 10.1A](#) where horizontal sight restrictions occur on downgrades, even when the horizontal sight obstruction is a cut slope. Use [Equation 12.5.4](#) and the grade adjusted SSD from [Figure 10.1C](#) to determine the length of vertical curve.
3. Minimum Length. The minimum length of a sag vertical curve in feet should be $3V$, where V is the design speed in miles per hour.
4. Minimum Values. Designs should be made to values as high as are commensurate with conditions. Minimum values should be used only where the use of higher value will result in unacceptable social, economic or environmental consequences.

Design Speed (miles per hour)	Stopping ¹ Sight Distance (feet)	Rate of Vertical Curvature ³ , K-Value	
		Calculated	Design
15	80	9.4	10
20	115	16.5	17
25	155	25.5	26
30	200	36.4	37
35	250	49.0	49
40	305	63.4	64
45	360	78.1	79
50	425	95.7	96
55	495	114.9	115
60	570	135.7	136
65	645	156.5	157
70	730	180.3	181
75	820	205.6	206
80	910	231.0	231

Notes:

1. Stopping sight distances (SSD) are from [Figure 10.1A](#).
2. Maximum K-value for drainage on curbed roadways and bridges is 167, see [Section 12.5.2.5](#).
3.
$$K = \frac{SSD^2}{400 + 3.5SSD}, \text{ where: } h_3 = 2 \text{ feet}$$

**K-VALUES FOR SAG VERTICAL CURVES — STOPPING SIGHT DISTANCES
(Passenger Cars — Level Grades)**

Figure 12.5C

12.5.2.3 Comfort Criteria

On fully lighted sections of highway and where it is impractical to provide a sag curve based on stopping sight distance, the sag vertical curve may be designed to meet the comfort criteria. These criteria are based on the effect of change in the vertical direction of a sag vertical curve due to the combined gravitational and centrifugal forces. The general consensus is that riding is comfortable on sag vertical curves when the centripetal acceleration does not exceed 1 foot/second². The length-of-curve equation for the comfort criteria is:

$$L = \frac{AV^2}{46.5} \quad \text{(Equation 12.5.7)}$$

where:

L = length of vertical curve, feet

A = absolute value of the algebraic difference between the two tangent grades, percent

V = design speed, miles per hour

12.5.2.4 Underpasses

Check sag vertical curves through underpasses to insure that the underpass structure does not obstruct the driver's visibility. Use the following equation to check sag vertical curves through underpasses:

$$L = \frac{AS^2}{800(C - 4.25)} \quad \text{(Equation 12.5.8)}$$

where:

L = length of vertical curve, feet

A = absolute value of the algebraic difference between the two tangent grades, percent

S = sight distance, feet

C = vertical clearance of underpass, feet

Compare the L calculated from [Equation 12.5.8](#) for underpasses with the L calculated based on headlight illumination ([Equation 12.5.4](#)). The larger of the two lengths will govern.

12.5.2.5 Drainage

Proper drainage must be considered in the design of sag vertical curves on highways with curbs, bridges and medians with concrete median barriers. Drainage problems are minimized if the sag vertical curve is sharp enough so that a minimum longitudinal gradient of at least 0.3 percent is reached at a point about 50 feet from either side of the low point. This results in a K-value of 167 or less. For most design speeds, the K-values are less than 167; see [Figure 12.5C](#). However, for higher design speeds and/or where longer sag vertical curves are required on highways with curbs or on bridges, it may be necessary to install additional inlets on either side of the low point.

For a highway without curbs, drainage should not be a problem at sag vertical curves if the highway has proper cross slopes.

12.5.3 Vertical Curve Computations

The following will apply to the mathematical design of vertical curves:

1. Definitions. [Figure 12.5D](#) presents the common terms and definitions used in vertical curve computations.
2. Measurements. All measurements for vertical curves are made on the horizontal or vertical plane, not along the profile grade line. With the simple parabolic curve, the vertical offsets from the tangent vary as the square of the horizontal distance from the VPC or VPT. Elevations along the curve are calculated as proportions of the vertical offset at the point of vertical intersection (VPI). The equations for computing a symmetrical vertical curve are shown in [Figure 12.5E](#). [Figure 12.5F](#) provides an example of how to use these formulas.
3. Vertical Curve Through Fixed Point. The vertical curve of a highway often must be designed to pass through an established elevation and location. For example, it may be necessary to tie into an existing side road or to clear existing structures. [Figure 12.5G](#) provides the procedure for determining how to pass a vertical curve through a fixed point. [Figure 12.5H](#) illustrates an example on how to use these formulas.
4. VPI Stationing. The designer may need to determine the VPI station between two known VPI's. [Figure 12.5I](#) illustrates how to determine the intermediate VPI given the gradients, stations and elevations of the other VPI's.

ELEMENT	ABBREVIATION	DEFINITION
Vertical Point of Curvature	VPC	The point at which a tangent grade ends and the vertical curve begins.
Vertical Point of Tangency	VPT	The point at which the vertical curve ends and the tangent grade begins.
Vertical Point of Intersection	VPI	The point where the extension of two tangent grades intersect.
Grade	G_1, G_2	The slope between two adjacent VPI's expressed as a percent. The numerical value for percent of grade is the vertical rise or fall in feet for each 100 feet of horizontal distance. Upgrades in the direction of stationing are identified as positive (+). Downgrades are identified as negative (-).
External Distance	E	The vertical distance (offset) between the VPI and the roadway surface along the vertical curve.
Algebraic Difference in Grade (Absolute Value)	A	The value of A is determined by the difference in percent between two tangent grades $ G_2 - G_1 $.
Length of Vertical Curve	L	The horizontal distance in feet from the VPC to the VPT.
Tangent Elevation	Tan. Elev.	The elevation on the tangent line between the VPC and VPI and the VPI and VPT.
Elevation on Vertical Curve	Curve Elev.	The elevation of the vertical curve at any given point along the curve.
Horizontal Distance	x	Horizontal distance measured from the VPC or VPT to any point on the vertical curve in feet.
Tangent Offset	y	Vertical distance from the tangent line to any point on the vertical curve in feet.
Low/High Point	x_T	The station at the high point for crest curves or the low point for sag curves. At this point, the slope of the tangent to the curve is equal to 0 percent.
Symmetrical Curve	—	The VPI is located at the mid-point between VPC and VPT stationing.

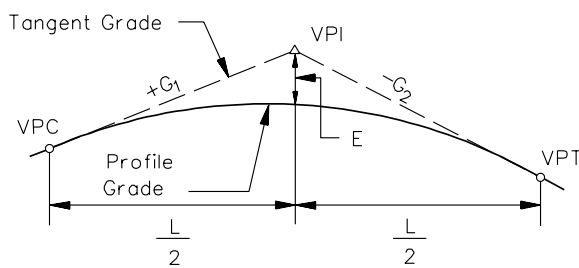

CREST VERTICAL CURVE

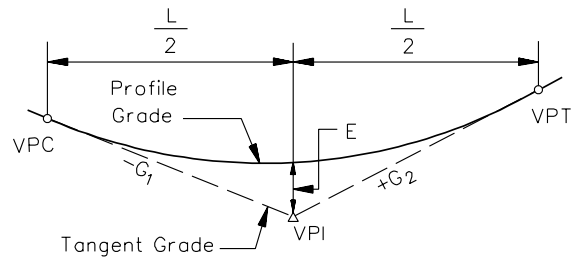

SAG VERTICAL CURVE

VERTICAL CURVE DEFINITIONS

Figure 12.5D

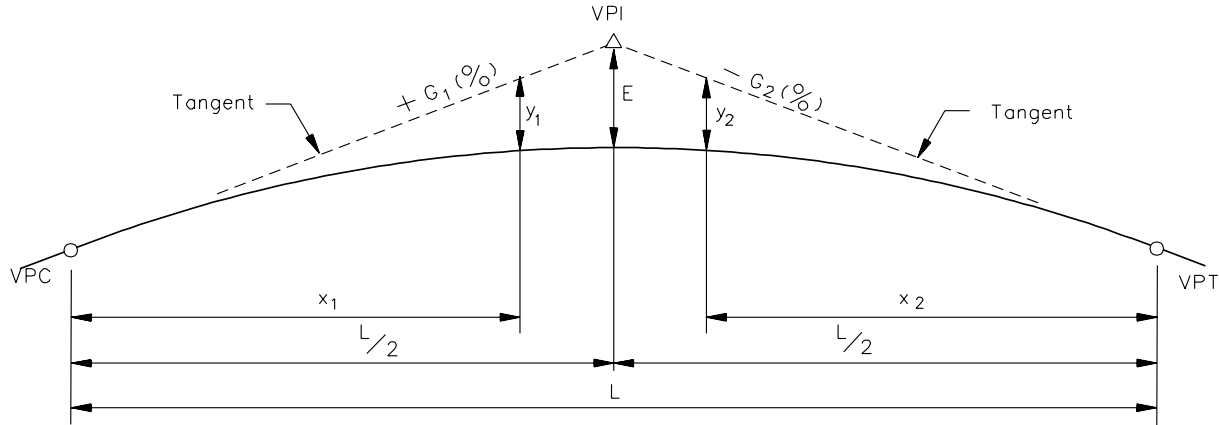

- E = External distance @VPI, feet
 y = Any tangent offset, feet
 L = Horizontal length of vertical curve, feet
 x = Horizontal distance from VPC or VPT to any ordinate "y", feet
 G_1 & G_2 = Rates of grade, expressed algebraically, percent

NOTE: ALL EXPRESSIONS TO BE CALCULATED ALGEBRAICALLY
(Use algebraic signs of grades; grades in percent.)

1. Elevations of VPC and VPI:

$$\text{VPC ELEV.} = \text{VPI ELEV.} - \left(\frac{G_1}{100} \times \frac{L}{2} \right) \quad (\text{Equation 12.5.9})$$

$$\text{VPT ELEV.} = \text{VPI.} + \left(\frac{G_2}{100} \times \frac{L}{2} \right) \quad (\text{Equation 12.5.10})$$

2. For the elevation of any point "x" on a vertical curve:

$$\text{CURVE ELEV.} = \text{TAN ELEV.} \pm y \quad (\text{Equation 12.5.11})$$

Where:

Left of VPI (x_1 measured from VPC):

$$(a) \quad \text{TAN ELEV.} = \text{VPC ELEV.} + \left(\frac{G_1}{100} \right) x_1 \quad (\text{Equation 12.5.12})$$

$$(b) \quad y_1 = x_1^2 \frac{(G_2 - G_1)}{200 L} \quad (\text{Equation 12.5.13})$$

SYMMETRICAL VERTICAL CURVE EQUATIONS

Figure 12.5E

Right of VPI (x_2 measured from VPT):

$$(a) \quad \text{TAN ELEV.} = \text{VPT ELEV.} - \left(\frac{G_2}{100} \right) x_2 \quad (\text{Equation 12.5.14})$$

$$(b) \quad y_2 = x_2^2 \frac{(G_2 - G_1)}{200 L} \quad (\text{Equation 12.5.15})$$

At the VPI:

$$y = E \text{ and } x = L / 2$$

$$(a) \quad \text{TAN ELEV.} = \text{VPC ELEV.} + \frac{G_1 L}{200}$$

or $\text{TAN ELEV.} = \text{VPT ELEV.} - \frac{G_2 L}{200}$ (Equation 12.5.16)

$$(b) \quad E = \frac{L(G_2 - G_1)}{800} \quad (\text{Equation 12.5.17})$$

3. Calculating high or low point in the vertical curve:

$$(a) \quad \text{To determine distance "x}_T\text{" from VPC: } x_T = \frac{L G_1}{G_1 - G_2} \quad (\text{Equation 12.5.18})$$

$$(b) \quad \text{To determine high or low point stationing: } \text{VPC STA.} + x_T \quad (\text{Equation 12.5.19})$$

$$(c) \quad \text{To determine high or low point elevation on a vertical curve:}$$

$$\text{ELEV.}_{\text{HIGH OR LOW POINT}} = \text{VPC ELEV.} - \frac{L G_1^2}{(G_2 - G_1) 200} \quad (\text{Equation 12.5.20})$$

Revised Equation 12.5.18 and 12.5.19 for calculating high or low point in vertical curve – 9-2008

SYMMETRICAL VERTICAL CURVE EQUATIONS

(Continued)

Figure 12.5E

Example 12.5(1)

Given: $G_1 = -1.75$ percent
 $G_2 = +2.25$ percent
 Elev. of VPI = 591.00 feet
 Station of VPI = 10 + 85.00
 $L = 1200$ feet
 Symmetrical Vertical Curve
 Rural Area

Problem: Compute the vertical curve elevations for each 100-foot station. Compute the low point elevation and stationing.

Solution:

1. Draw a diagram of the vertical curve and determine the stationing at the beginning (VPC) and the end (VPT) of the curve.

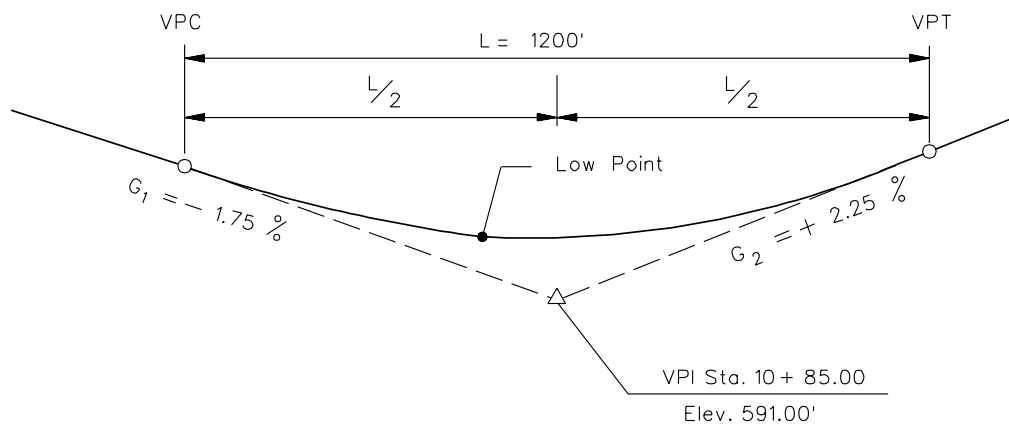

$$\text{VPC Station} = \text{VPI Sta} - \frac{1}{2}L = (10 + 85) - 600 = 4 + 85.00$$

$$\text{VPT Station} = \text{VPI Sta} + \frac{1}{2}L = (10 + 85) + 600 = 16 + 85.00$$

2. Elevations of VPC and VPI:

$$\text{VPC ELEV.} = 591.00 - \left(\frac{-1.75}{100} \times \frac{1200}{2} \right) = 601.50 \text{ feet} \quad (\text{Equation 12.5.9})$$

$$\text{VPT ELEV.} = 591.00 + \left(\frac{2.25}{100} \times \frac{1200}{2} \right) = 604.50 \text{ feet} \quad (\text{Equation 12.5.10})$$

3. Set up a table to show the vertical curve elevations at the 100-foot stations, substituting the values into [Equations 12.5.12](#) through [12.5.15](#). Calculate the elevation to the nearest 0.01 foot.

SYMMETRICAL VERTICAL CURVE COMPUTATIONS
(Example 12.5(1))

Figure 12.5F

Example 12.5(1)

Solution: (Continued)

Station	Control Point	Tangent Elevation (feet)	x	x ²	y= x ² /60,000	Grade Elevation (feet)
4+85	VPC	601.50	0	0	0.00	601.50
5+85		599.75	100	10000	0.17	599.92
6+85		598.00	200	40000	0.67	598.67
7+85		596.25	300	90000	1.50	597.75
8+85		594.50	400	160000	2.67	597.17
9+85		592.75	500	250000	4.17	596.92
10+85	VPI	591.00	600	360000	6.00	597.00
11+85		593.25	500	250000	4.17	597.42
12+85		595.50	400	160000	2.67	598.17
13+85		597.75	300	90000	1.50	599.25
14+85		600.00	200	40000	0.67	600.67
15+85		602.25	100	10000	0.17	602.42
16+85	VPT	604.50	0	0	0.00	604.50

4. Calculate the low point using Equations 12.5.18, 12.5.19 and 12.5.20:

$$x_T = \frac{1200 (-1.75)}{-1.75 - 2.25} = \frac{-2100}{-4.00} = 5 + 25 \text{ ft from VPC}$$

therefore, the Station at the low point is:

$$\text{VPC}_{\text{STA}} + x_T = (4 + 85) + (5 + 25) = 10 + 10.00$$

Elevation at the low point on curve is:

$$\text{Elev. Of low point} = 601.50 - \frac{1200 (-1.75)^2}{(2.25 - (-1.75)) 200} = 601.50 - 4.59 = 596.91 \text{ feet}$$

Corrected low point calculation – 9-2008

VERTICAL CURVE COMPUTATIONS

(Example 12.5(1))

(Continued)

Figure 12.5F

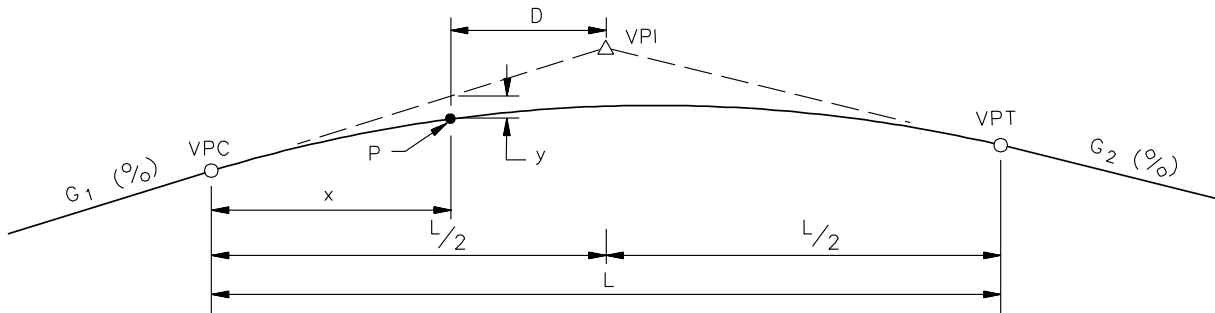

G_1 = Grade in, percent

D = Distance from "P" to VPI, feet

G_2 = Grade out, percent

L = Length of vertical curve, feet

A = Algebraic difference in grades, percent

y = Vertical curve correction at point "P", feet

x = Distance from VPC to "P", feet

Given: G_1, G_2, D

Problem: Determine the length of a vertical curve required to pass through a given point (P).

Solution:

1. Find algebraic difference in grades:

$$A = G_2 - G_1$$

$$\text{VPT ELEV.} = \text{VPI ELEV.} + \left(\frac{G_2}{100} \right) \left(\frac{L}{2} \right) \quad (\text{Equation 12.5.21})$$

2. Find vertical curve correction at Point P:

$$y = x^2 \left(\frac{G_2 - G_1}{200 L} \right)$$

From Equation 12.5.13 (x measured from VPC):

3. From inspection of the above diagram:

$$x + D = L / 2 \text{ or } L = 2(x + D) \quad (\text{Equation 12.5.22})$$

SYMMETRICAL VERTICAL CURVE THROUGH A GIVEN POINT

Figure 12.5G

By substituting $2(x+D)$ for L , and A for $(G_2 - G_1)$ into [Equation 12.5.13](#). Yields:

$$A x^2 + (-400 y) x + (-400 D y) = 0 \quad (\text{Equation 12.5.23})$$

4. Solve for "x" using the quadratic equation:

$$x = \frac{-b \pm \sqrt{b^2 - 4ac}}{2a} = \frac{400y \pm \sqrt{160000 y^2 + 1600ADy}}{2A} \quad (\text{Equation 12.5.24})$$

Solving for "X" will result in two answers. If both answers are positive, there are two solutions. If one answer is negative, it can be eliminated and only one solution exists.

5. Substitute X and D into [Equation 12.5.22](#) and solve for L:

Note: Two positive X values, will result in two L solutions. Desirably, use the longer vertical curve solution provided it meets the sight distance criteria (based on the selected design speed and algebraic difference in grades).

SYMMETRICAL VERTICAL CURVE THROUGH A GIVEN POINT

(Continued)

Figure 12.5G

Example 12.5(2)

Given: Design Speed = 55 miles per hour
 $G_1 = -1.5$ percent
 $G_2 = +2.0$ percent
 $A = 3.5$ percent
 VPI Station = 29 + 00.00
 VPI Elevation = 652.40 feet

Problem: At Station 27 + 50, a new highway must pass under the center of an existing railroad that is at elevation 679.78 feet at the highway centerline. The railroad bridge that will be constructed over the highway will be 4 feet in depth, 20 feet in width and at right angles to the highway. Determine the length of the symmetrical vertical curve that would be required to provide a 16 feet-6 inches clearance under the railroad bridge.

Solution:

1. Sketch the problem with known information labeled.

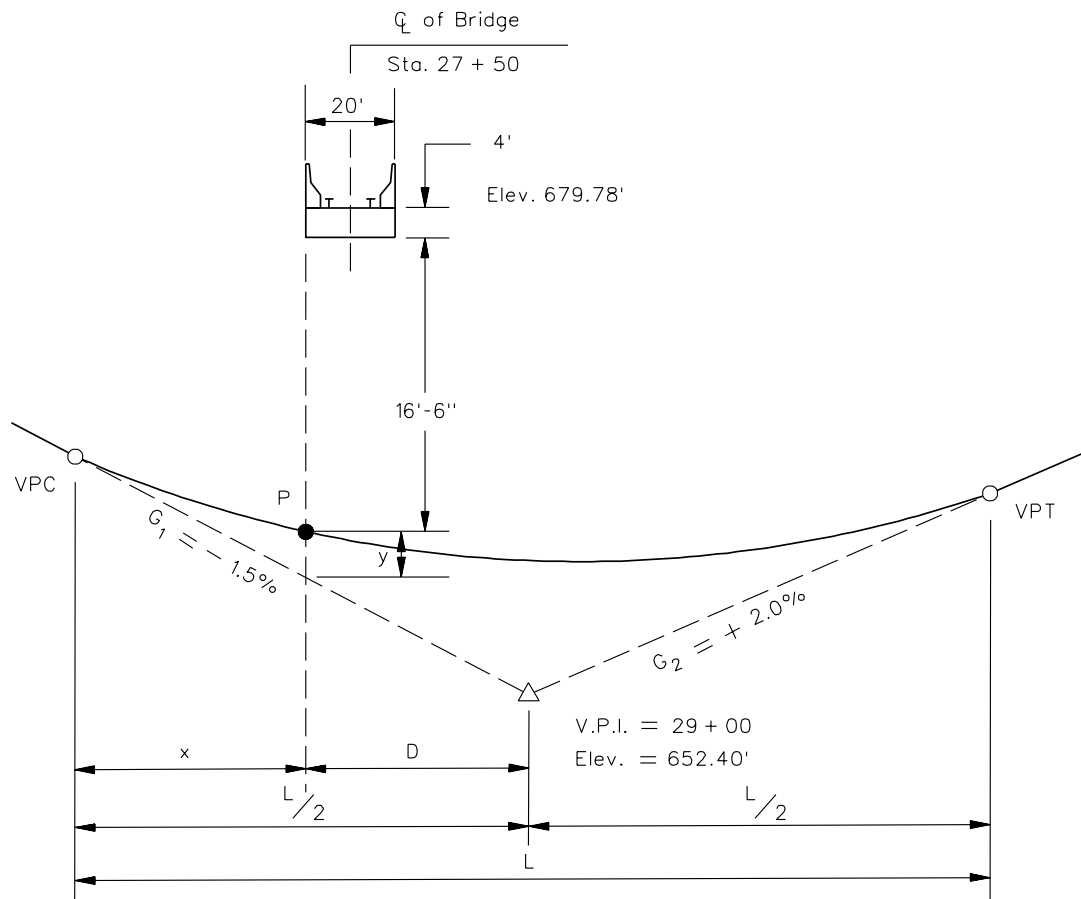

**SYMMETRICAL VERTICAL CURVE THROUGH A GIVEN POINT
 (Example 12.5(2))**

Figure 12.5H

Example 12.5(2) (continued)

2. Determine the station where the minimum 16'-6" vertical clearance will occur (Point P):

From inspection of the sketch, the critical location is on the left side of the railroad bridge. The critical station is:

$$\text{STA. P} = \text{BRIDGE CENTERLINE STATION} - \frac{1}{2} (\text{BRIDGE WIDTH})$$

$$\text{STA. P} = \text{STA. 27} + 50 - \frac{1}{2} (20)$$

$$\text{STA. P} = \text{STA. 27} + 40$$

3. Determine the elevation of Point P:

$$\text{ELEV. P} = \text{ELEV. TOP RAILROAD BRIDGE} - \text{BRIDGE DEPTH} - \text{CLEARANCE}$$

$$\text{ELEV. P} = 679.78 - 4.0 - 16.5$$

$$\text{ELEV. P} = 659.28 \text{ feet}$$

4. Determine distance, D, from Point P to VPI:

$$D = \text{STA. VPI} - \text{STA. P} = (29 + 00) - (27 + 40) = 160 \text{ feet}$$

5. Determine the tangent elevation at Point P:

$$\text{ELEV. TANGENT AT P} = \text{VPI ELEV.} - \left(\frac{G_1}{100} \right) D = 652.40 - \left(\frac{-1.5}{100} \right) 160 = 654.80 \text{ feet}$$

6. Determine the vertical curve correction (y) at Point P:

$$y = \text{ELEV. ON CURVE} - \text{ELEV. OF TANGENT} = 659.28 - 654.80 = 4.48 \text{ feet}$$

SYMMETRICAL VERTICAL CURVE THROUGH A GIVEN POINT**(Example 12.5(2))**

(Continued)

Figure 12.5H

7. Solve for x using [Equation 12.5.24](#):

$$x = \frac{400(4.48) \pm \sqrt{(160000)(4.48)^2 + 1600(3.5)(160)(4.48)}}{2(3.5)}$$

$$x = 640 \text{ feet AND } x = -128 \text{ feet (Disregard)}$$

8. Using [Equation 12.5.22](#), solve for L:

$$L = 2(x + D)$$

$$L = 2(640 + 160)$$

$$L = 1600 \text{ feet}$$

9. Determine if the solution meets the desirable passenger car stopping sight distance for the 55 mile-per-hour design speed. From [Figure 12.5C](#), the minimum design K-value:

$$K = 115$$

The algebraic difference in grades:

$$A = G_2 - G_1 = (+2.0) - (-1.5) = 3.5.$$

From [Equation 12.5.6](#), determine the minimum length of vertical curve which meets the desirable stopping sight distance:

$$L_{\text{MIN}} = KA$$

$$L_{\text{MIN}} = (115) 3.5 = 402.5 \text{ feet}$$

L = 1600 feet, which exceeds the minimum design stopping sight distance.

SYMMETRICAL VERTICAL CURVE THROUGH A GIVEN POINT

(Example 12.5(2))

(Continued)

Figure 12.5H

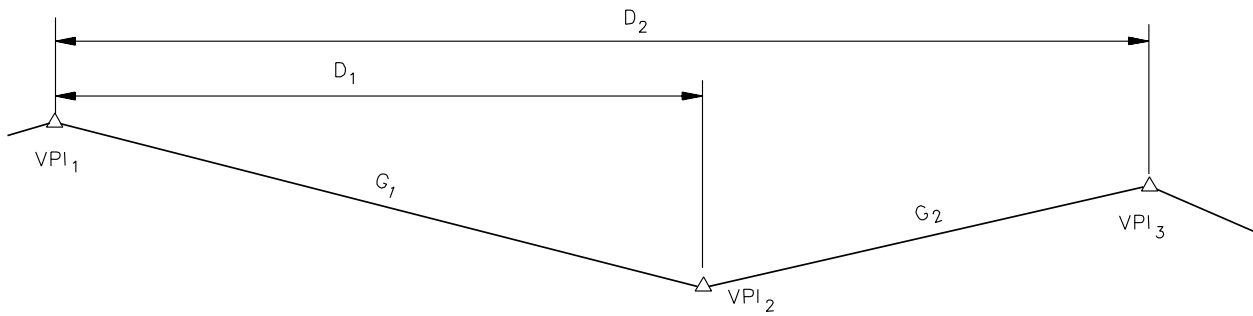

D_1 = Distance between VPI₁ and VPI₂, feet

D_2 = Distance between VPI₁ and VPI₃, feet

Example 12.5(3)

Given: Station and Elevation at VPI₁
 Station and Elevation at VPI₃
 G_1, G_2 (percent)

Problem: Find Station and Elevation of VPI₂.

Solution:

1. Find the station of VPI₂:

$$D_1 = \frac{(\text{ELEV. VPI}_3 - \text{ELEV. VPI}_1) - G_2 D_2}{G_1 - G_2} \quad (\text{Equation 12.5.25})$$

$$\text{STA. VPI}_2 = \text{STA. VPI}_1 + D_1$$

2. Find the elevation of VPI₂:

$$\text{ELEV. VPI}_2 = \text{ELEV. VPI}_1 + G_1 D_1 \quad (\text{Equation 12.5.26})$$

VERTICAL CURVE COMPUTATION (Intermediate VPI) (Example 12.5(3))

Figure 12.5I

12.6 VERTICAL CLEARANCES

Vertical clearances should be established above all sections of the roadway surface, including the shoulder. [Chapters 19 through 22](#) present the minimum roadway vertical clearances for new construction and reconstruction projects and the minimum clearances for structures allowed to remain-in-place. In addition to the criteria presented in this Chapter, consider the following:

1. Pedestrian Bridges. See [Chapters 19 through 22](#) for the minimum vertical clearance under pedestrian bridges.
2. Sign Trusses. Sign structures over all routes should be a minimum 17 feet-6 inches.
3. Traffic Signals. On all new or reconstruction projects, provide a minimum vertical clearance of 16 feet-6 inches with a maximum clearance of 18 feet-0 inches. Consult with the Traffic Engineering Division for additional guidance. Measure this clearance from the roadway surface to the bottom of the signal housing or to the bottom of the back plate.
4. Railroads. The minimum vertical clearance for all facilities over railroads is 23 feet-0 inches.
5. Navigable Water. Review the US Coast Guard permit requirements to determine the minimum vertical clearance.
6. Lakes and Reservoirs. Provide a minimum vertical clearance of 8 feet-0 inches above the high water mark for the lake or reservoir.

12.7 REFERENCES

1. *A Policy on Geometric Design of Highways and Streets*, AASHTO, 2001.
2. *Highway Capacity Manual 2000*, TRB, 2000.

Table of Contents

<u>Section</u>	<u>Page</u>
13.1 DEFINITIONS/NOMENCLATURE.....	13.1(1)
13.2 ROADWAY SECTION.....	13.2(1)
13.2.1 Typical Sections	13.2(1)
13.2.2 Pavement Surface Type	13.2(1)
13.2.3 Traveled Way	13.2(2)
13.2.3.1 Lane Widths	13.2(2)
13.2.3.2 Provisions for Bicycles on Traveled Way.....	13.2(3)
13.2.3.3 Traveled Way Cross Slopes.....	13.2(3)
13.2.4 Shoulders	13.2(5)
13.2.4.1 Function.....	13.2(5)
13.2.4.2 Shoulder Width.....	13.2(6)
13.2.4.3 Shoulder Cross Slopes.....	13.2(6)
13.2.4.4 Use of Rumble Strips on Shoulders	13.2(7)
13.2.5 Auxiliary Lanes	13.2(7)
13.2.6 Miscellaneous Roadway Elements.....	13.2(8)
13.2.6.1 Sidewalks	13.2(8)
13.2.6.2 On-Street Parking Lanes.....	13.2(9)
13.2.6.3 Curbed Sections.....	13.2(9)
13.3 ROADSIDE ELEMENTS	13.3(1)
13.3.1 Slopes and Ditches.....	13.3(1)
13.3.1.1 Purpose	13.3(1)
13.3.1.2 Fill Slopes.....	13.3(1)
13.3.1.3 Cut Slopes.....	13.3(2)
13.3.1.4 Ditch Section	13.3(4)
13.3.1.5 Roadside Safety.....	13.3(4)
13.3.2 Roadside Features	13.3(4)
13.3.3 Geotechnical Features	13.3(4)
13.3.4 Aesthetics.....	13.3(5)

Table of Contents

(Continued)

<u>Section</u>	<u>Page</u>
13.4 MEDIANS	13.4(1)
13.4.1 Functions	13.4(1)
13.4.2 Median Types	13.4(1)
13.4.2.1 Flush Medians	13.4(1)
13.4.2.2 Raised Medians.....	13.4(3)
13.4.2.3 Depressed Medians	13.4(3)
13.4.3 Median Selection.....	13.4(3)
13.5 BRIDGE AND UNDERPASS CROSS SECTIONS	13.5(1)
13.5.1 Bridges	13.5(1)
13.5.1.1 Bridge Roadway Widths	13.5(1)
13.5.1.2 Vertical Clearance	13.5(1)
13.5.1.3 Highway Grade Separations.....	13.5(1)
13.5.1.4 Highway Overpassing Railroad	13.5(1)
13.5.2 Underpasses	13.5(3)
13.5.3 Traveled Way Width Reductions	13.5(3)
13.6 REFERENCES.....	13.6(1)

Chapter Thirteen

CROSS SECTION ELEMENTS

The highway cross section will establish the basic operational and safety features for the facility, and it will have a significant impact on the project cost, especially for earthwork. [Chapters 19 through 22](#) contain the Typical Sections and design criteria for cross sections of freeways, rural highways, suburban/urban streets, and local roads and streets for South Carolina. This Chapter provides additional guidance which should be considered in the design of these cross section elements, including the roadway section, roadway elements, medians and bridge and underpass cross sections.

13.1 DEFINITIONS/NOMENCLATURE

[Figures 13.1A, 13.1B, 13.1C](#) and [13.1D](#) provide the basic nomenclature for cross section elements for freeways, rural highways, urban streets with curb and gutter and urban street valley gutters. The following definitions apply to the highway cross section:

1. Auxiliary Lane. The portion of the roadway adjoining the through traveled way for purposes supplementary to through traffic movement including parking, speed change, turning, storage for turning, weaving or truck climbing.
2. Backslope. The side slope created by the connection of the ditch bottom or shelf, upward and outward, to the natural ground.
3. Back Lip. The portion of a valley gutter section beyond the gutter.
4. Buffer. Where used, the area or strip, between the roadway and a sidewalk.
5. Cross Slope. The slope in the cross section view of the travel lanes, expressed as a percent or ratio based on the change in horizontal compared to the change in vertical.
6. Depressed Median. A median that is lower in elevation than the traveled way and designed to carry a certain portion of the roadway runoff.
7. Divided Highway. A roadway that has separate traveled ways, usually with a depressed or CMB median for traffic in opposite directions.
8. Fill Slopes. Slopes extending outward and downward from the shoulder hinge point to intersect the natural ground line.
9. Flush Median. A paved median that is essentially level with the surface of the adjacent traveled way.

10. Foreslope. This is the side slope in a cut section created by connecting the shoulder to the ditch hinge point, downward and outward.
11. Median Slope. The slope in the cross section view of a median beyond the shoulder, expressed as a ratio of the change in horizontal to the change in vertical.
12. Hinge Point. The point where the height of fill and depth of cut are determined. For fills, the point is located at the intersection of the shoulder and the fill slope. For cuts, the hinge point is located at the toe of the backslope.
13. Roadway. The combination of the traveled way, both shoulders or curb and gutters, and any auxiliary lanes on the mainline highway. Traveled ways separated by a depressed median have two or more roadways.
14. Shelf. On curbed facilities, the relatively flat area located between the back of the curb and the break for the fill or backslopes.
15. Shoulder. The portion of the roadway contiguous to the traveled way for the accommodation of stopped vehicles, for emergency use, and for lateral support of base and surface courses. On sections with curb and gutter, the shoulder includes the gutter.
16. Shoulder Slope. The slope in the cross section view of the shoulders, expressed as a percent or ratio.
17. Slope Offset. On curbed facilities with sidewalks, the distance between the back of the sidewalk and the break for the fill slope or backslope.
18. Sloping Curb (Mountable Curb). A longitudinal element placed at the roadway edge for delineation, to control drainage, to control access, etc. Sloping curbs have a height of 6 inches or less with a face no steeper than 1 horizontal (H) to 3 vertical (V).
19. Toe of Slope. The intersection of the fill slope or foreslope with the natural ground or ditch bottom.
20. Top of Slope (Cut). The intersection of the backslope with the natural ground.
21. Traveled Way. The portion of the roadway for the movement of vehicles, exclusive of shoulders and auxiliary lanes.
22. Two-Way-Left-Turn-Lane (TWLTL). A lane in the median area that extends continuously along a street or highway and is marked to provide a deceleration and storage area, out of the through traffic stream, for vehicles traveling in either direction to use in making left turns.

23. Undivided Highway. A roadway that does not have a physical barrier (e.g., depressed median, CMB median) between opposing traffic lanes.
24. Valley Gutter. A paved longitudinal element placed at the roadway edge to control drainage. The valley gutter is designed with a backslope of 10 percent and a width of 3 feet or greater.
25. Vertical Curb (Barrier Curb). A longitudinal element, typically concrete, placed at the roadway edge for delineation, to control drainage, to control access, etc. Vertical curbs may range in height between 6 and 12 inches with a face no steeper than 1 horizontal (H) to 6 vertical (V).

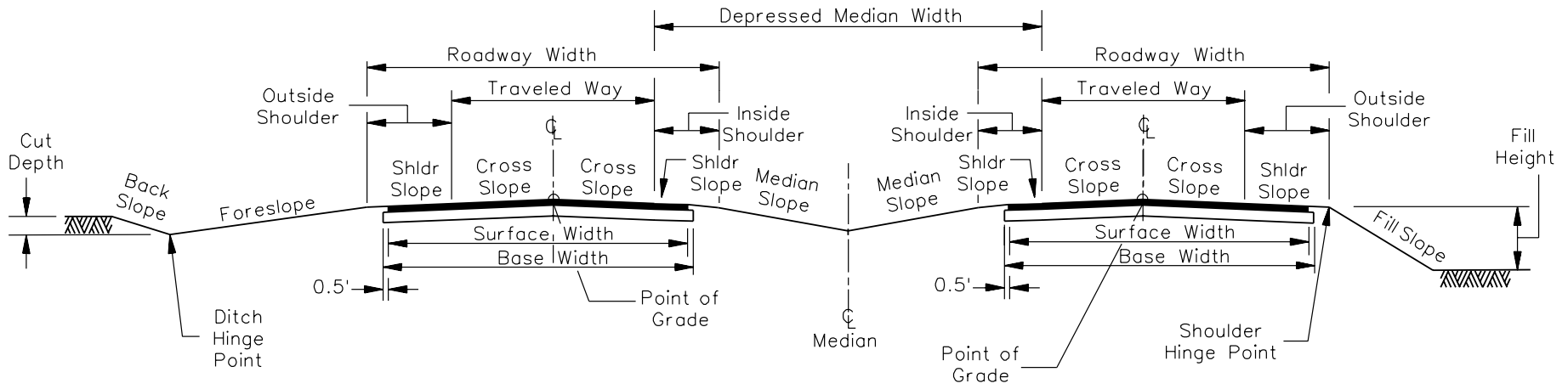

FREEWAY NOMENCLATURE
Figure 13.1A

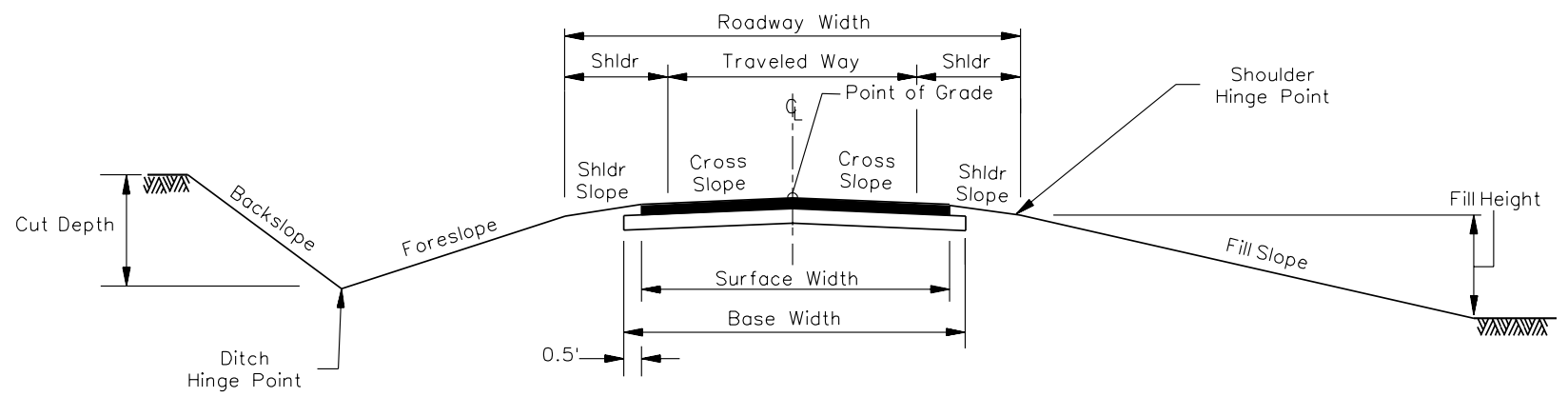

RURAL NOMENCLATURE
Figure 13.1B

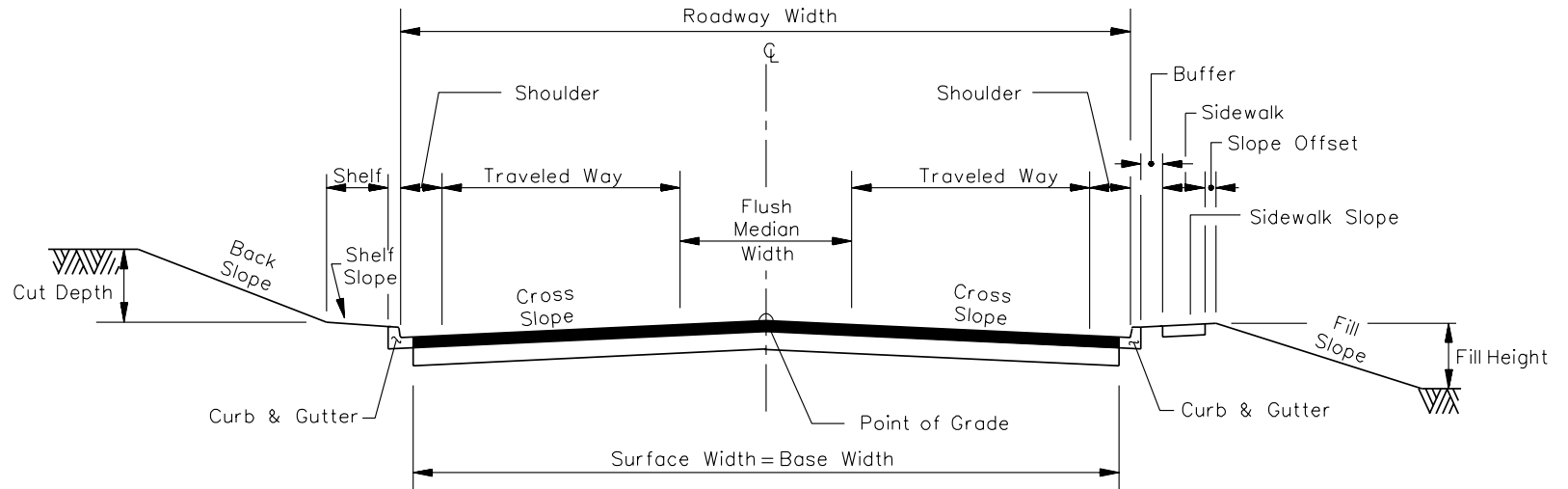

**URBAN NOMENCLATURE
(Curb and Gutter)**

Figure 13.1C

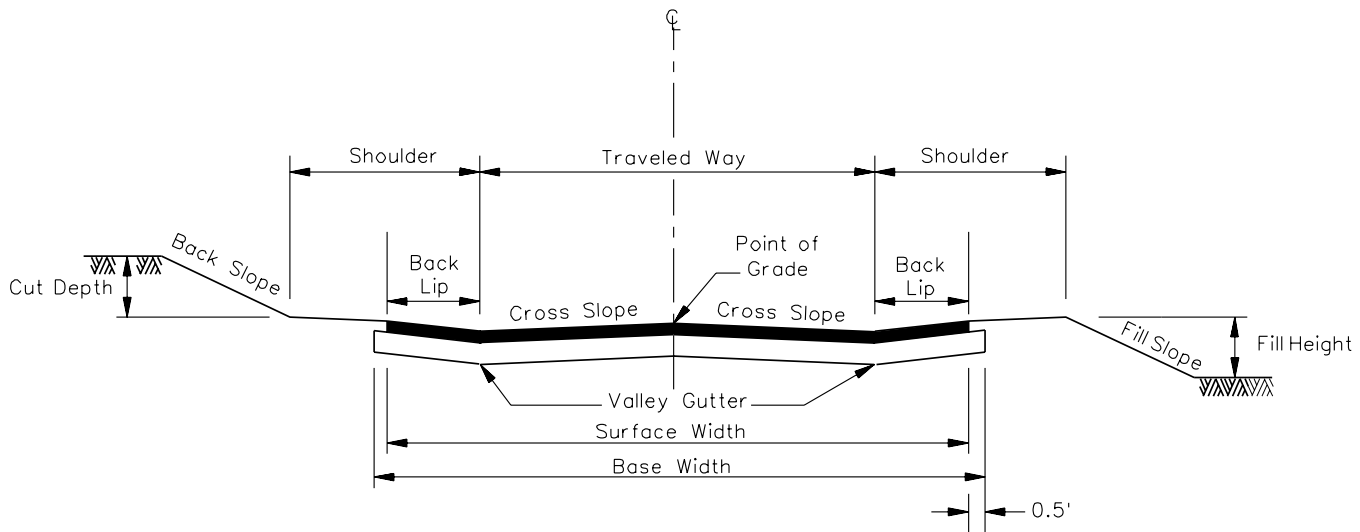

**URBAN NOMENCLATURE
(Valley Gutter)**

Figure 13.1D

13.2 ROADWAY SECTION

13.2.1 Typical Sections

Typical Sections are graphical representations with dimensions showing the width, limits and slopes of the various cross sectional elements the designer uses for a particular project. Typical Sections generally illustrate one side in a fill section and the other side in a cut section for both normal crown and superelevated sections. Typical Sections detail the thickness, depth and layers of the pavement structural components. Typical Sections for freeways, rural highways, suburban/urban streets and local roads and streets are presented in [Chapters 19 through 22](#), respectively.

13.2.2 Pavement Surface Type

The selection of pavement type requires the designer to consider the following factors:

- volume and composition of traffic,
- soil characteristics,
- weather,
- historical performance of various pavement types in the project area,
- energy conservation,
- availability of materials,
- initial costs, and
- life cycle costs.

Pavements are generally classified into one of three categories – high, intermediate and low. The selection of the appropriate type pavement for a particular road, street or highway is primarily based upon the anticipated volume and type of traffic. For more information on pavement selection, see the Department's latest *Instructional Bulletin*, "Guidelines for Hot Mix Asphalt Selection." The Department uses the following pavement types:

1. High-Type Pavements. High-type pavements are classified as asphaltic concrete (flexible) or concrete (rigid). They are used wherever the designer expects high volumes of traffic. Adequate design and construction techniques should allow pavements to retain their cross sectional shape, smooth riding qualities, to drain properly and maintain good skid-resistant properties throughout their expected service life. The primary objective in the selection, design and construction of high-type pavements is to insure maximum performance. The proper design and construction avoids performing non-routine maintenance and the resultant interruption and annoyance to traffic operations as well as the associated increased cost to the responsible governmental entity and the highway user.

2. Intermediate-Type Pavements. Intermediate pavements are designed to lesser criteria than the high type. Intermediate-type pavements are a variety of bituminous surface treatments on a prepared base. These are generally used on collectors and local roads and streets.
3. Low-Type Pavements. Low-type surfaces are generally prevalent on very low volume roads and normally consist of earth-type base (sand-clay) and earth base with macadam, stabilized aggregate or some other type of stone surface. The Department has a very limited number of roadways with this type of pavement.

13.2.3 Traveled Way

The traveled way is the area upon which vehicles travel. The traveled way has a great influence on the operational safety of any highway facility whether it is a two-lane rural road or an urban multilane freeway.

13.2.3.1 Lane Widths

Lane widths range from 9 to 14 feet with the 12-foot width being the most common practice for highway facilities. The following are several factors used in determining lane widths:

1. Highway Classification. Highway classification and type are major determining factors in the selection of lane width. Generally, highway classification is a function of expected traffic usage. Arterials and freeways will have wider widths while collectors and local streets and roads will have narrower widths. [Chapters 19 through 22](#) provide lane widths for the various functional classifications.
2. Traffic Volume. The volume of traffic is also a factor in determining lane width. For example, a wider lane provides desirable clearances between vehicles traveling in opposite directions on two-lane, two-way rural highways when high traffic volumes and high percentages of commercial vehicles are expected.
3. Width Considerations. In general, wider lanes have a greater capacity than narrow lanes because motorists are less inhibited by the close proximity of adjacent traffic. This results in a higher running speed and, in some instances, increases capacity. However, widths greater than 12 feet do not necessarily increase traffic capacity. Guidelines for lane widths for specific types of roadways are provided in the design criteria tables of [Chapters 19 through 22](#).
4. Lateral Obstructions. Consider the location of lanes with respect to curbs and other lateral obstructions when selecting appropriate lane widths. Motorists tend to avoid close obstacles; therefore, wider lanes are needed. The absence of a usable shoulder and the close proximity of obstructions to the edge of the

traveled way also influence driver behavior. For more information on lateral obstructions and the effects on driver behavior, see [Chapter 14](#).

5. Trucks. Significant volumes of trucks influence the lane width selection. The size and location of trucks, within their respective travel lane, have a similar effect as a lateral obstruction on both opposing and adjacent traffic. Trucks tend to cause other traffic to travel at reduced running speeds that reduces overall capacity.

13.2.3.2 Provisions for Bicycles on Traveled Way

Provisions for bicycles are an important consideration where new highways are being constructed or existing highways are being widened or otherwise improved. This is particularly true in urban and suburban areas and where tourism is a major factor. In many instances, the following low capital investment measures can considerably enhance highway safety and provide capacity for bicycle traffic:

- paved shoulders with a minimum usable shoulder width of 4 feet,
- travel lanes 14 feet wide (or wider) if there is limited shoulder width or curb and gutter,
- bicycle-safe drainage grates,
- smooth riding surfaces,
- separate facilities where bicycle traffic is expected to be high and where additional rights of way can be obtained reasonably,
- adjusting manhole covers to the grade, and
- removing or redesigning existing rumble strips.

For additional guidance on bike lanes, see the AASHTO *Guide for the Development of Bicycle Facilities*.

13.2.3.3 Traveled Way Cross Slopes

The purpose of the pavement cross slope is to promote rapid removal of drainage from the pavement surface while enabling the driver to maintain control of the vehicle. Because low-type pavements are loose and pervious, they require a greater cross slope than high-type surfaces in order to reduce saturation of the unpaved surface and base materials. [Figure 13.2A](#) presents cross slopes for the various types of pavements used by the Department.

Surface Class	Surface Type	Cross Slope
High	Hot Mix Asphalt Concrete Surface Course or Portland Cement Concrete on a Prepared Base.	2.08% (48H:1V) for first 2 lanes
Intermediate	Bituminious Surface Treatment on a Prepared Subbase.	2.08% (48H:1V)
Low	Earth Base/Stabilized Aggregate or Macadam.	2.78% (36H:1V) and 4.17 (24H:1V)

NORMAL PAVEMENT CROSS SLOPES

Figure 13.2A

Cross slopes of 2.08 percent are permitted for up to two lanes plus one half the width of a flush median. Pavement beyond the second lane should have a cross slope of 2.78 percent. This is for travel lanes as well as auxiliary lanes. Where profile grades are less than 2.00 percent with curb and gutter, the designer may consider using a cross slope of 2.78 percent for the outside lane.

The following further describes the cross slopes used by the Department based on highway classification:

1. Two-Lane Highways. Crown the traveled way pavement at the centerline and use a cross slope of 2.08 percent away from the centerline.
2. Four-Lane Divided Highways. Crown the traveled way pavement at the centerline of each roadway and use a cross slope of 2.08 percent away from the centerline for all lanes.
3. Three-, Five- or Seven-Lane Highways (with TWLTL). Crown the pavement at the center of the TWLTL and use a cross slope of 2.08 percent away from the centerline for all lanes on three- and five-lane highways. For a seven-lane section, the cross slope of the outside lane will be 2.78 percent.
4. Six-Lane Highways with a Concrete Median Barrier (CMB). The following will apply:
 - a. CMB Raised. Crown the median at the centerline of the CMB and use a slope of 2.08 percent away from the center for the inside shoulders and for the first two travel lanes adjacent to the inside shoulder. Use a slope of 2.78 percent for the third lane breaking away from the outside edge of the second travel lane.
 - b. CMB Depressed. When the median is lower than the adjacent traveled way, the traveled way will be crowned between the first and second travel lanes (i.e., one lane sloping to the inside and two lanes sloping to the outside). The cross slope on all travel lanes will be 2.08 percent. The inside shoulder is sloped towards the CMB at a rate of 4.17 percent.

13.2.4 Shoulders

13.2.4.1 Function

Shoulders are defined as that portion of the roadway contiguous to the traveled way. They extend from the edge of the travel lane to the intersection of the foreslope. Shoulders may either be earth type or paved or a combination of both. Useable shoulders constitute the actual width of shoulder available for emergency stopping. For examples of shoulders, see [Figure 13.2B](#).

Shoulders serve many functions, and the wider the shoulder, the greater the benefits. Shoulder functions include:

- providing structural support for the traveled way,
- increasing highway capacity,
- encouraging uniform travel speeds,
- providing space for emergency and discretionary stops,
- improving roadside safety by providing more recovery area for run-off-the-road vehicles,
- providing a sense of openness,
- improving sight distance around horizontal curves,
- enhancing highway aesthetics,

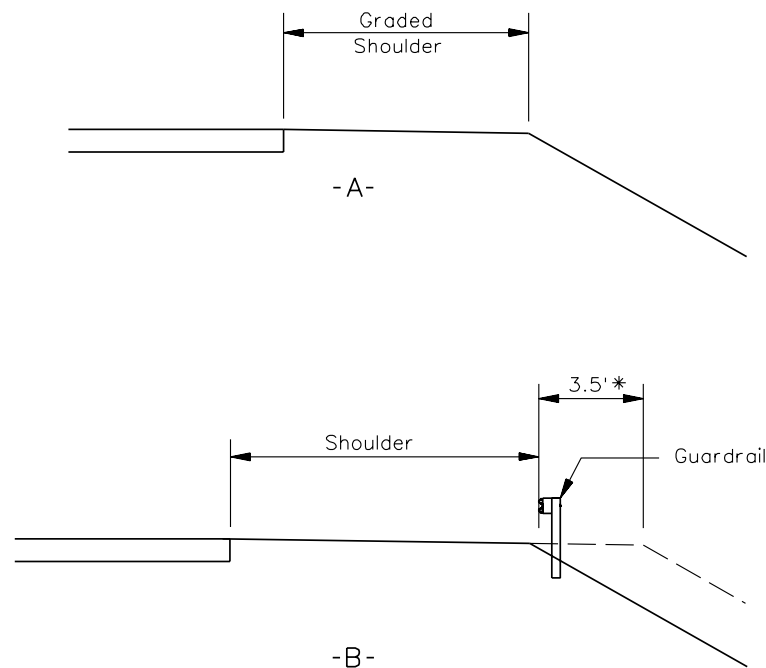

* Add 3.5' to the shoulder for roadside barrier and lateral support.

SHOULDERS

Figure 13.2B

- facilitating maintenance operations,
- providing additional lateral clearance to roadside appurtenances,
- facilitating pavement drainage,
- providing space for pedestrian and bicycle use, and
- providing space for bus stops.

13.2.4.2 Shoulder Width

Shoulder widths will vary according to functional classification, traffic volumes and urban or rural location. The design criteria tables in [Chapters 19 through 22](#) present the shoulder width criteria for the various conditions.

In addition, guardrail can influence the shoulder width. Where guardrail is provided, increase the width of the shoulder by 3.5 feet to maintain the desirable useable width and to provide support for the guardrail. See [Figure 13.2B](#).

13.2.4.3 Shoulder Cross Slopes

Greater cross slopes are provided on shoulders than on adjacent travel lanes for two reasons: 1) the runoff carried across the shoulder is a combined total of both the adjacent travel lane and the shoulder; and 2) in many cases, the shoulder surface material is rougher than the adjacent travel lane requiring a steeper slope to maintain a similar flow rate. Not all shoulders are paved, so it is necessary to remove the water as rapidly as possible before it penetrates the shoulder with the potential of reducing its structural support capabilities. Normal shoulder slopes are shown in [Figure 13.2C](#). Note that for superelevated sections **on new construction projects**, the high side is sloped at the superelevated rate and the low side is sloped at the **superelevation rate when the slope exceeds** normal shoulder slope. See [Figure 13.2D](#) for shoulder treatments with superelevated sections. For additional guidance on superelevated sections, see [Chapter 11](#).

All shoulders should be structurally adequate to support truck usage for emergency purposes. In addition, shoulder materials should also be sufficiently stable to provide lateral support of the adjacent pavements.

Surface Class	Surface Type	Cross Slope
Paved	Hot Mix Asphalt Concrete or Portland Cement Concrete	4.17%* (24H:1V)
Turf	Compacted Earth with Grass Surface	8.33% (12H:1V)

* If paved shoulder is 2 feet or less, continue the travel way cross slope.

NORMAL SHOULDER CROSS SLOPES

Figure 13.2C

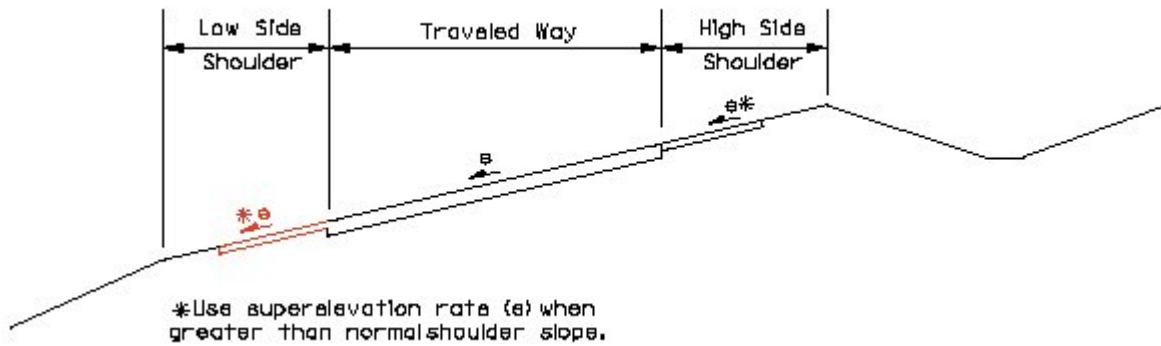

SUPERELEVATED SHOULDER SLOPES

Figure 13.2D

For maintenance operations, it is advantageous for the shoulders to be delineated from through traffic lanes. This generally can be accomplished by using a different surface treatment, a different surface gradation and finish, or by pavement markings if the same surface material is used for both the traveled way and shoulder and by use of rumble strips.

13.2.4.4 Use of Rumble Strips on Shoulders

Rumble strips on the shoulder can potentially prevent run-off-the-road crashes by alerting sleepy or inattentive drivers. However, other factors must be considered when using rumble strips, including:

- use of the shoulder by bicyclists,
- impact on pavement life,
- impact on maintenance operations, and
- initial construction costs.

Consider installing continuous, milled shoulder rumble strips on all freeways as an effective means of reducing single vehicle, run-off-the-road crashes caused primarily by any form of motorist inattention. This includes paved inside and outside shoulders of 4 to 10 feet. Do not use mill-in rumble strips on ramps, acceleration lanes or deceleration lanes. Place a note on the plan sheet showing “Begin Mill-in Rumble Strip” and “End Mill-in Rumble Strip” with an arrow to the appropriate location; see *SCDOT’s Standard Drawings*. Typically, SCDOT uses rumble strips only on freeways.

13.2.5 Auxiliary Lanes

Auxiliary lanes are any lanes beyond the basic through travel lanes. They are intended for use by vehicular traffic for specific functions (e.g., TWLTL). The following will apply to the design of auxiliary lanes:

1. Width. With the exception of TWLTL, the width of an auxiliary lane is typically the same as that of the adjacent through lane. Auxiliary lane widths for various classifications of highways are provided in the design criteria tables in [Chapters 19 through 22](#).
2. Types. Auxiliary lanes include:
 - single left- and right-turn lanes at intersections,
 - double left- and right-turn lanes at intersections,
 - truck climbing lanes,
 - acceleration/deceleration lanes at interchanges or intersections,
 - weaving lanes within an interchange,
 - continuous auxiliary lanes between two closely spaced interchanges,
 - two-way, left-turn lanes (TWLTL),
 - parking lanes, and
 - passing lanes.
3. Shoulders. The shoulder width adjacent to the auxiliary lane should be the same as the normal shoulder width for the approaching roadway. At a minimum, the width should be 4 feet assuming the roadway has a shoulder width equal to or greater than 4 feet.
4. Cross Slope. The cross slope for an auxiliary lane will depend on the number of lanes and cross slope of the adjacent traveled way. If the auxiliary lane is the second lane from the crown, it will be sloped at 2.08 percent. If the auxiliary lane is the third or fourth lane from the crown, it will be sloped at 2.78 percent. See [Section 13.2.3.3](#) for additional information on cross slopes.

13.2.6 Miscellaneous Roadway Elements

Miscellaneous roadway elements include sidewalks, parking lanes, and curbs and curbed sections. This section provides a brief overview of these elements. For more detail on the design criteria for these elements, see [Chapter 21](#).

13.2.6.1 Sidewalks

Generally, sidewalks are an integral part of city streets. For suburban residential areas, the construction of sidewalks is often deferred. However, sidewalks in rural and suburban areas are still often justified at points of community development such as schools, local businesses, shopping centers and industrial plants that result in pedestrian concentrations along the highway. If pedestrian activity is anticipated, include sidewalks as part of the construction.

For additional guidance on sidewalks, see [Section 21.2.10](#).

13.2.6.2 On-Street Parking Lanes

Adjacent land use may create a demand for on-street parking within urban areas and in rural communities. Parking lanes provide convenient access for motorists to businesses and residences. However, on-street parking reduces capacity, impedes traffic flow and increases the crash potential.

The decision to retain existing on-street parking or to introduce on-street parking should be compatible with the future land use and in cooperation with the local community. For additional guidance on parking lanes, see [Section 21.2.8](#).

13.2.6.3 Curbed Sections

Curbs are often used on urban facilities to control drainage, delineate the pavement edge, channelize vehicular movements, control access, limit right of way needs, provide separation between vehicles and pedestrians and present an attractive appearance. For curbed sections with a sidewalk, use a slope of 50H:1V for the sidewalk sloping towards the roadway. For curbed sections without a sidewalk, provide a 6-foot shelf with a 30H:1V slope towards the curb. See the *Standard Drawings* for more information. Generally, curbs are not used in rural areas.

Selecting a curbed section or one without curbs depends upon many variables and the decision will be made on a case-by-case basis. See [Section 21.2.9](#) for guidance on curb and gutters.

13.3 ROADSIDE ELEMENTS

13.3.1 Slopes and Ditches

13.3.1.1 Purpose

Earth slopes are required to provide roadside and median ditches adjacent to highway facilities and to provide a stable transition from the highway profile to adjacent terrain features. Flat slopes also facilitate turf establishment and are often required for soil stability. Flat and well-rounded side slopes, combined with proper roadway elevations above natural ground lines also enhance the roadway aesthetically as well as provide easy accessibility with regard to maintenance operations.

Using broad flat slopes on roadside ditches, which are visible to the driver, lessen the feeling of restriction and add considerably to a driver's willingness to use the shoulder and earth slope area in emergencies. The use of flat side slopes for roadside ditches reduces both the depth and velocity of water, and thereby minimizes damage from erosion.

Slopes should be evaluated with respect to:

- right of way acquisition, and
- significant tree policy.

Modifications to the designed cut or fill slopes may be allowed upon request without the specific approval or authorization of the Program Manager provided the modifications do not significantly increase the cost to the project.

13.3.1.2 Fill Slopes

Fill slopes are the foreslopes extending outward and downward from the shoulder hinge point to intersect the natural ground line. The slope criteria is dependent upon the functional classification, fill height, urban/rural location and the presence of curbs. Although [Chapters 19 through 22](#) provide design criteria for fill sections for each of the classifications of roadways, the designer must also consider right of way restrictions, utility considerations, roadside safety and roadside development in determining the appropriate fill slope. [Figure 13.3A](#) provides the fill slope ratios for typical conditions as measured from the shoulder hinge point.

Fill Height	*Foreslope Ratio
≤ 5 feet	6H:1V
5 < 10 feet	4H:1V
≥10 feet	2H:1V

*Foreslopes should be transitioned.

TYPICAL FILL SLOPE RATIOS

Figure 13.3A

13.3.1.3 Cut Slopes

The following cut slopes will apply:

1. Earth Cuts. In earth cuts on facilities without curbs, roadside ditches are provided to control drainage. The ditch section includes the foreslope, ditch width (typically a V ditch is used) and backslope as appropriate for the facility type. On facilities with curbs and no sidewalks, a shelf (typically 6 feet measured from the back of curb) is provided, and the backslope of 2H:1V is located beyond the shelf. See the Typical Sections in [Chapters 19 through 22](#).
2. Rock Cuts. In rock cuts, the backslope generally is 0.25H:1V but could vary depending on the type of rock and field conditions; see [Figure 13.3B](#). For large cuts, benching of the backslope may be required.

If the rock face is located within the clear zone, provide a smooth rock cut or shield it with a roadside barrier. If the rock face and ditch to capture falling rock is outside of the clear zone, a roadside barrier typically will not be warranted.

A hydraulic analysis should be performed to evaluate the need to control cascading water from the top of the cut and to determine the conveyance needs or roadside drainage at the toe of the cut.

3. Daylighting. Daylighting extends or flattens backslopes and can provide several benefits, including:
 - enhancing aesthetics,
 - enhancing roadside safety,
 - providing needed fill material,
 - removing undesirable features,
 - obliterating existing roadbeds, and
 - providing convenient outfall points for roadside drainage.

The decision to use daylighting should be made on a case-by-case basis.

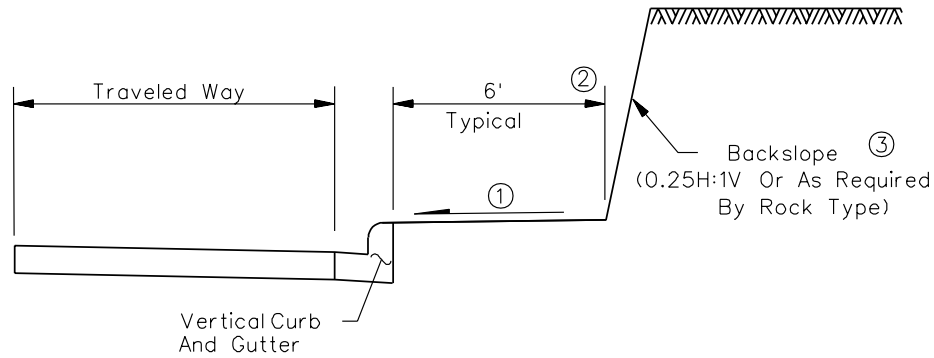

(A) CURB AND GUTTER SECTION

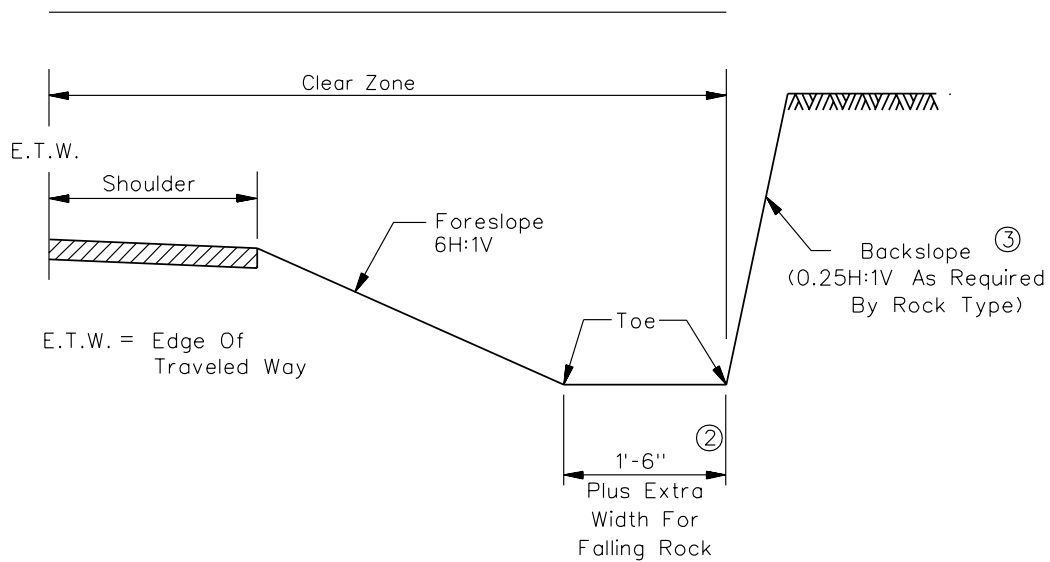

(B) DITCH SECTION

Notes:

- ① Use 50H:1V if sidewalks are presented or anticipated. Use 30H:1V if sidewalks are not present or anticipated.
- ② Discuss with the Geotechnical Section to determine extra width needed for falling rock.
- ③ Backslopes in rock may require benching. Contact the Geotechnical Section.

TYPICAL ROCK CUT SECTIONS**Figure 13.3B**

13.3.1.4 Ditch Section

A properly designed roadside ditch will insure the proper drainage of the pavement subgrade and the adequate conveyance of surface flow without creating erosion. Roadside ditches are provided adjacent to embankment locations and in cut sections.

The Department typically uses a V-ditch section along facilities without curb and gutter. The ditch section includes the foreslope and backslope. If the longitudinal gradient is greater than 3 percent, the Hydraulic Engineering Section will review the ditch design as well as include specially designed sediment control items and lining, as appropriate.

13.3.1.5 Roadside Safety

See [Chapter 14](#) for specific criteria to determine the necessary foreslope, ditch width and backslope combinations.

13.3.2 Roadside Features

See [Chapter 14](#) for information on roadside features.

13.3.3 Geotechnical Features

During the project development stage, the designer must insure that the topography and geology of the selected alignment and profile are compatible with the proposed fill and cut slope sections. All geotechnical data must be collected and analyzed as early as possible after the preliminary design phase. Plans, profiles and cross sections will be forwarded to the Research and Materials Laboratory to determine the boring locations and tests needed to perform a comprehensive geotechnical study report. The geotechnical report may encompass the following:

- geology of the terrain,
- embankment settlement,
- slope stability analysis,
- soil stabilization,
- soil support value,
- soil classification, and
- soil boring profiles.

The recommendations of the geotechnical report will be incorporated in the right of way plan preparation.

13.3.4 Aesthetics

There are various methods in which to improve the visual impact of a roadway. Varying the cross section elements will typically improve the aesthetics of the roadway. This may include:

- increasing or decreasing the side slopes to reduce the magnitude of exposed cut and fill slopes;
- reducing ditch widths or depths to reduce the amount of cut, with the approval of the Hydraulic Engineering Section;
- using slope rounding to blend cuts and fills into the natural ground;
- warping side slopes to match the natural landscape;
- retaining existing vegetation;
- using a raised or depressed median with plantings; and/or
- providing structures that match the natural landscape.

13.4 MEDIANS

13.4.1 Functions

A median is defined as the area of a divided highway separating the traffic into opposing directions. The principal functions of a median are:

- to provide separation from opposing traffic,
- to prevent undesirable turning movements,
- to provide an area for deceleration and storage of left-turning vehicles,
- to provide an area for storage of vehicles for emergency stopping,
- to facilitate drainage collection,
- to provide a recovery area for run-off-the-road vehicles,
- to provide an area for pedestrian refuge,
- to provide width for future lanes, and
- to minimize headlight glare.

13.4.2 Median Types

[Figure 13.4A](#) provides typical sections for the flush, flush with a concrete median barrier (CMB) and depressed medians.

13.4.2.1 Flush Medians

A flush median is defined as the paved median surface at essentially the same plane as the adjoining traveled way. Flush medians are used most often on urban highways and streets where design speeds are 45 miles per hour or less. The following will apply:

1. Flush. Typical widths for a flush median on an urban street can range from 4 to 15 feet. To accommodate a separate left-turn lane, a flush median should be at least 12 feet wide. Two-way, left-turn lanes (TWLTL) are also considered flush medians. They are paved and striped for delineation and normally 15 feet wide. To provide proper drainage they are typically crowned in the center with a cross slope of 2.08 percent in each direction. For additional information on flush medians, see [Section 21.2.6](#).
2. Flush with CMB. A flush median with a CMB may be used on urban freeways where the right of way may prohibit widening to the outside. Desirably, the existing medians should be sufficiently wide to allow for the addition of 12-foot wide travel lanes and 10-foot shoulders adjoining the CMB where there are three or more travel lanes in each direction. However, the predominant median width for most urban freeways in South Carolina is 36 feet. This allows for the use of two 12-foot travel lanes, a 2.5-foot wide CMB and two 4.75-foot wide shoulders.

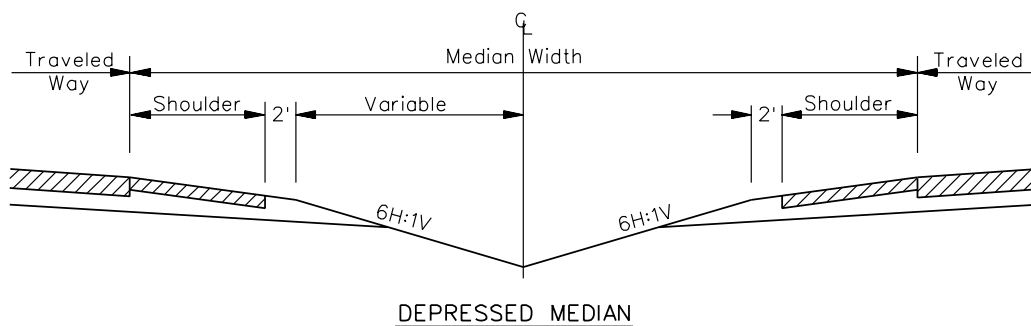
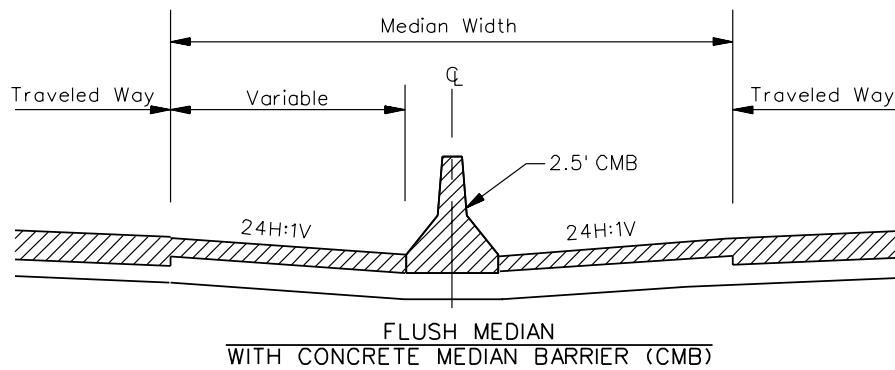
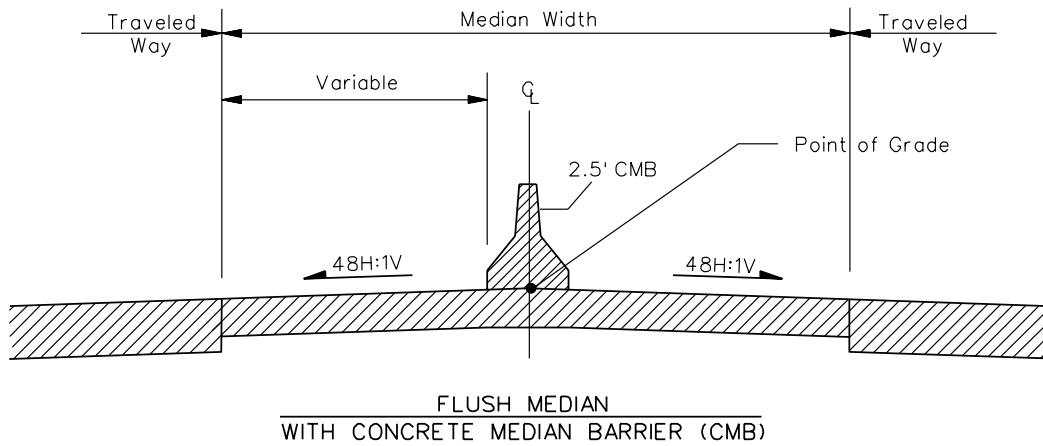
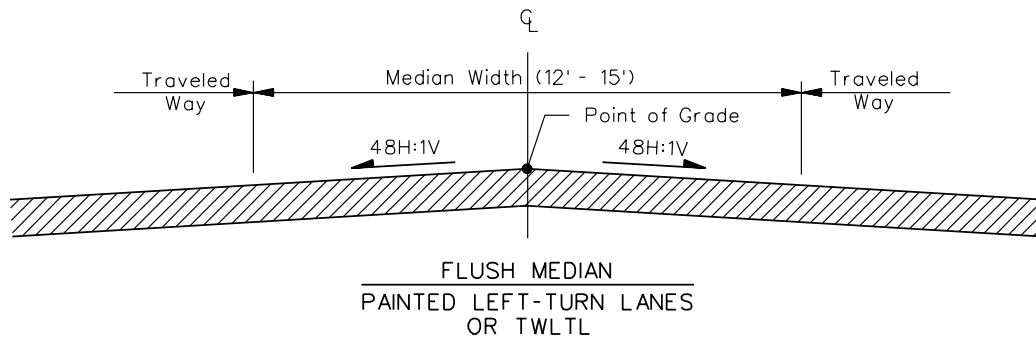

MEDIAN TYPES

Figure 13.4A

13.4.2.2 Raised Medians

In general, the Department does not use raised medians. They may only be considered by special request. When used, consider the following:

1. Design Speed. Raised medians should only be used where the design speed is 45 miles per hour or less.
2. Width. Enough right of way should be available for widths that will provide space for the initial and future installation of left-turn lanes at public street intersections and high-traffic generator locations. At intersections, the raised median is typically 4 feet wide. The length may be determined by need for control of turning maneuvers near the intersection.
3. Access Control. Access to driveways and other private developments will be restricted unless a median opening is provided.
4. Green Areas. Raised medians delineating green areas in the center of roadways should be curb and gutter. Give special attention to eliminate areas that trap water in transition from normal to superelevated sections. Cross slopes in the median are 30H:1V.

13.4.2.3 Depressed Medians

A depressed median is typically used on freeways and other divided rural arterials. Depressed medians typically have good drainage characteristics and, therefore, are preferred on major highways.

Depressed medians should be as wide as practical to allow for the addition of future travel lanes on the inside while maintaining a sufficient future median width. The minimum width is 48 feet. This allows for the initial development of a depressed median with 6H:1V side slopes and a ditch with sufficient depth to accommodate the runoff. The 48-foot width allows for two future travel lanes with two 10-foot shoulders and a 4-foot CMB section. The maximum width for a depressed median is approximately 84 feet with 8H:1V side slopes. Beyond this, the two roadways of the divided facility are typically placed on independent alignment.

13.4.3 Median Selection

When selecting a median type, recognition must be given to urban/rural location, access needs, design speeds, availability of right of way, safety, capacity, intersection spacing, traffic signals, sight distance, turn-lane length, economics, environmental impacts, public appearance and functional classification. Higher functional classifications will

warrant a greater effort in managing access to a street or highway and in retaining mobility.

On certain projects, more than one median type may be necessary and/or desirable. The length of a project will be a major influence in this determination. On relatively short highway sections, the number of different median types should be limited to a select few. On longer highway projects, changes of median types should generally be made at the borders of natural cultural subdivisions.

The following are some characteristics of the different median types:

1. Flush Medians. Flush medians provide an area for left-turn movements and permit direct access to adjoining properties. This allows for numerous unrestricted conflict points. The flush median may serve as refuge for disabled vehicles and serve as a temporary lane for emergency vehicles.
2. Raised Medians. Raised medians also provide for left-turn movements at select locations. They allow for better access management. This median provides a refuge area for pedestrians and an open space for aesthetic considerations.
3. Depressed Medians. Although additional right of way is required, depressed medians provide wider separation between opposing flows and greater drainage capabilities. Wide depressed medians may provide for future widening.

13.5 BRIDGE AND UNDERPASS CROSS SECTIONS

The roadway cross section should be carried over and under bridges, which often requires special considerations because of the confining nature of bridges and their high unit costs.

13.5.1 Bridges

13.5.1.1 Bridge Roadway Widths

In general, bridge widths should match the approach roadway widths (traveled way plus shoulders). [Figure 13.5A](#) provides guidelines for bridge widths. However, in determining the width for major water crossings, consider the cost of the structure, traffic volume and potential for future width requirements.

13.5.1.2 Vertical Clearance

Vertical clearances should be established above all sections of pavement including the shoulder. [Section 12.6](#) and the design criteria tables in [Chapters 19 through 22](#) provide the minimum vertical clearances for new construction and reconstruction projects.

13.5.1.3 Highway Grade Separations

Horizontal clearances for highway grade separation structures, where guardrail or barrier protection is not provided, should conform to the requirements in [Figure 13.5B](#); however, they may be reduced where protection is provided. These are minimum requirements and should be increased as required.

13.5.1.4 Highway Overpassing Railroad

The horizontal clearance, measured from the centerline of the track to the face of the adjacent bridge substructure, should be a minimum of 25 feet. The horizontal clearance from the centerline of track to the face of the embankment fill slope, measured to the elevation to the highest rail, should be 20 feet. This 20-foot clearance may be increased at individual structure locations, as required, to provide adequate drainage or to allow adequate room to accommodate other special situations (e.g., future tracks).

When an existing overpass over a railroad is to be widened or rehabilitated, the existing horizontal clearances should be maintained, if less than 25 feet.

Approach Roadway	Conditions	Bridge Width (Gutter to Gutter)
Urban Streets (Curb and Gutter)	With or without concrete sidewalk.	Provide a sidewalk on bridge matching roadway gutter hinge points with bridge gutter hinge points.
Freeways and Arterials	12-foot shoulder (10 foot paved + 2 foot unpaved).	Use 12-foot shoulder hinge point for bridge gutter line.
	10-foot shoulder (paved and unpaved).	Use 10-foot shoulder hinge point for bridge gutter line.
	10-foot shoulder (6 foot paved + 4 foot unpaved).	Use 10-foot shoulder hinge point for bridge gutter line on inside of divided highways.
	10-foot shoulder (4 foot paved + 6 foot unpaved).	
Rural Collectors and Local Roads	6- to 8- foot shoulders (2 foot paved + 4 to 6 foot unpaved) with paved roadway.	Use shoulder hinge point for bridge gutter line. Bridge width is equal to width of roadway section (outside shoulder to outside shoulder).
Ramps	In direction of traffic (left) 10-foot shoulder (4 foot paved + 6 foot unpaved).	Use 10-foot shoulder line for bridge gutter line.
	In direction of traffic (right) 10-foot shoulder (6 foot paved + 4 foot unpaved).	Use 10-foot shoulder hinge point for bridge gutter line.

GUIDELINES FOR BRIDGE ROADWAY WIDTHS

Figure 13.5A

Highway Below Structure	Horizontal Clearance to Overpassing Structure*
Design Speed \leq 40 mph	10 feet from edge of traveled way
Design Speed = 45 to 50 mph	20 feet from edge of traveled way
Design Speed \geq 55 mph	30 feet from edge of traveled way

* or as determined by clear zone requirements, if greater.

HORIZONTAL CLEARANCES

Figure 13.5B

13.5.2 Underpasses

The approaching roadway cross section, including any auxiliary lanes, should be carried through the underpass. Desirably, include the clear zone width for each side through the underpass. It is important to consider the potential for further development or traffic increases in the vicinity of the underpass that may significantly increase traffic or pedestrian volumes. If appropriate, an allowance for future widening may be provided to allow for sufficient lateral clearance for one additional lane in each direction.

13.5.3 Traveled Way Width Reductions

When approaching a narrow bridge or underpass, the traveled way width may need to be reduced to allow the roadway to pass over or under a bridge. The Department determines the need for traveled way reductions on a case-by-case basis. Where it is deemed necessary, design the traveled way reduction transitions using the taper rates in [Figure 13.5C](#).

Design Speed (mph)	Taper Rate
30	20:1
35	25:1
40	40:1
45	45:1
50	50:1
55	55:1
60	60:1
65	65:1
70	70:1

Note: Taper Length (L) = Taper Rate x Offset Distance

TAPER RATES FOR LANE REDUCTIONS

Figure 13.5C

13.6 REFERENCES

1. *A Policy on Geometric Design of Highways and Streets*, AASHTO, 2001.
2. *Guide for the Development of Bicycle Facilities*, AASHTO, 1999.
3. *Highway Capacity Manual 2000*, TRB, 2000.
4. *Roadway Shoulder Rumble Strips*, Technical Advisory #T5040.35, FHWA, 2001.
5. *Roadside Design Guide*, AASHTO, 1996.
6. NCHRP Report 375, *Median Intersection Design*, 1995.
7. *Manual on Uniform Traffic Control Devices, Millennium Edition*, FHWA, ATSSA, AASHTO and ITE, 2001.

Table of Contents

<u>Section</u>	<u>Page</u>
14.1 APPLICATION	14.1(1)
14.1.1 Appurtenance Type	14.1(1)
14.1.2 Coordination With Other Publications	14.1(2)
14.2 DEFINITIONS	14.2(1)
14.3 ROADSIDE CLEAR ZONES	14.3(1)
14.3.1 Background	14.3(1)
14.3.2 Clear Zone Values	14.3(2)
14.3.2.1 Speed	14.3(2)
14.3.2.2 Design Year	14.3(2)
14.3.2.3 Traffic Volumes	14.3(2)
14.3.2.4 Side Slopes	14.3(2)
14.3.2.5 Alignment (Horizontal Curve Adjustment)	14.3(5)
14.3.2.6 Facilities with Curbs	14.3(5)
14.3.2.7 Lane Width	14.3(8)
14.3.2.8 Auxiliary Lanes	14.3(8)
14.3.3 Fill Slopes	14.3(9)
14.3.3.1 Recoverable Fill Slopes	14.3(9)
14.3.3.2 Critical Fill Slope	14.3(9)
14.3.4 Roadside Ditches	14.3(9)
14.4 ROADSIDE BARRIER WARRANTS	14.4(1)
14.4.1 Range of Treatments	14.4(1)
14.4.2 Warrant Methodologies	14.4(1)
14.4.2.1 Department Policy	14.4(1)
14.4.2.2 Engineering Judgment Method	14.4(1)
14.4.2.3 Cost-Effectiveness Method	14.4(2)
14.4.3 Roadside Hazards	14.4(2)
14.4.4 Embankments	14.4(3)
14.4.5 Transverse Slopes	14.4(3)
14.4.6 Roadside Drainage Features	14.4(6)

Table of Contents

(Continued)

<u>Section</u>	<u>Page</u>
14.4.6.1	Curbs..... 14.4(6)
14.4.6.2	Cross Drainage Structures 14.4(7)
14.4.6.3	Parallel Drainage Structures..... 14.4(9)
14.4.7	Roadside Ditches (Earth Cuts) 14.4(9)
14.4.8	Rock Cuts..... 14.4(12)
14.4.9	Bridge Rails 14.4(12)
14.4.10	Retaining Walls 14.4(12)
14.4.11	Traffic Control Devices 14.4(13)
14.4.11.1	Highway Signs..... 14.4(13)
14.4.11.2	Traffic Signal Equipment 14.4(14)
14.4.12	Luminaires..... 14.4(14)
14.5	ROADSIDE BARRIERS 14.5(1)
14.5.1	Types..... 14.5(1)
14.5.1.1	Steel Beam Guardrail 14.5(1)
14.5.1.2	Thrie Beam..... 14.5(1)
14.5.1.3	Half-Section Concrete Barrier..... 14.5(1)
14.5.1.4	Other Systems..... 14.5(2)
14.5.2	Barrier Selection..... 14.5(2)
14.5.2.1	Performance Criteria 14.5(2)
14.5.2.2	Dynamic Deflection 14.5(2)
14.5.2.3	Maintenance..... 14.5(3)
14.6	ROADSIDE BARRIER LAYOUT 14.6(1)
14.6.1	Length of Need 14.6(1)
14.6.1.1	Basic Calculation..... 14.6(1)
14.6.1.2	End Terminals 14.6(12)
14.6.1.3	Length of Need (Outside of Horizontal Curves)..... 14.6(12)
14.6.1.4	Length of Need (Bridge Approaches) 14.6(12)

Table of Contents

(Continued)

<u>Section</u>	<u>Page</u>
14.6.2 Lateral Placement.....	14.6(12)
14.6.3 Placement Behind Curbs.....	14.6(14)
14.6.4 Placement on Slopes.....	14.6(16)
14.6.5 Barrier Flare	14.6(16)
14.6.6 Terminal Treatments	14.6(16)
14.6.7 Transitions.....	14.6(17)
14.6.8 Minimum Length/Gaps	14.6(18)
14.6.9 Adjustable Height Guardrail.....	14.6(18)
 14.7 MEDIAN BARRIERS.....	 14.7(1)
14.7.1 Types.....	14.7(1)
14.7.2 Median Barrier Warrants/Selection.....	14.7(1)
14.7.3 Median Barrier Layout.....	14.7(1)
14.7.3.1 Median Slopes.....	14.7(2)
14.7.3.2 Flared/Divided Median Barriers	14.7(2)
14.7.3.3 Terminal Treatments	14.7(3)
14.7.3.4 Superelevation	14.7(3)
14.7.3.5 Maintenance/Emergency Crossovers.....	14.7(3)
14.7.3.6 Barrier-Mounted Obstacles.....	14.7(3)
14.7.4 Glare Screens	14.7(3)
 14.8 IMPACT ATTENUATORS (Crash Cushions).....	 14.8(1)
14.8.1 General.....	14.8(1)
14.8.2 Warrants.....	14.8(1)
14.8.3 Impact Attenuator Types	14.8(1)
14.8.4 Impact Attenuator Selection	14.8(1)
14.8.5 Impact Attenuator Design	14.8(2)
14.8.5.1 Deceleration	14.8(2)
14.8.5.2 Placement	14.8(4)
 14.9 REFERENCES.....	 14.9(1)

Chapter Fourteen

ROADSIDE SAFETY

The ideal roadway would be entirely free of any roadside obstructions or other hazardous conditions. This is rarely practical because of natural, economic and environmental factors. Chapter 14 presents clear zone distances which should adequately provide a clear recovery area for approximately 80 percent of errant vehicles that run off the road. In addition, the Chapter provides criteria for the use of roadside barriers, median barriers and impact attenuators where providing the clear zone is not practical.

14.1 APPLICATION

This Section presents the SCDOT application of roadside safety decisions based on project type and appurtenance type. Chapter 14 presents the roadside safety criteria for all new construction/reconstruction projects.

14.1.1 Appurtenance Type

The following summarizes the Department's roadside safety responsibilities based on type of appurtenance:

1. Bridge Rails. The Bridge Design Section is responsible for establishing Department criteria for the selection and design of all bridge rails. The Road Design Section is responsible for the roadside barrier and terminal section approaching the bridge rail.
2. Traffic Control Devices. The Traffic Engineering Division is responsible for establishing Department criteria for the design of structural supports for traffic control devices (e.g., breakaway bases for large signs) and luminaires. For the location of traffic control devices, the Traffic Engineering Division determines the initial placement, and the road designer insures that the proposed location is compatible with the roadway design.
3. All Other Appurtenances. The Road Design Section is responsible for establishing Department criteria for all other roadside safety appurtenances (e.g., roadside barriers, median barriers, impact attenuators).

14.1.2 Coordination With Other Publications

In addition to Chapter 14, the designer should use several other SCDOT publications to provide a proper treatment for roadside safety applications:

- the *SCDOT Standard Drawings*,
- the *SCDOT Road Design Plan Preparation Guide*, and
- *Roadside/Median Barriers and End Treatments, NCHRP 350*.

The designer should also review the *AASHTO Roadside Design Guide* and may need to review other publications in the roadside safety literature to address special issues.

14.2 DEFINITIONS

1. Backslope. The side slope created by connecting the ditch bottom or shelf, upward and outward, to the natural ground line.
2. Barrier. A device which provides a physical limitation through which a vehicle would not normally pass. It is intended to contain or redirect an errant vehicle. These can be further defined as follows:
 - a. Rigid Barrier. A longitudinal barrier which does not deflect upon impact. Concrete barrier and bridge parapets are rigid barriers.
 - b. Semi-Rigid Barrier. A longitudinal barrier ranging from almost rigid to quite flexible. Guardrail is a semi-rigid barrier.
 - c. Safety Shape Barrier. A concrete barrier with a single slope on the face of the barrier. Considered an innovative barrier.
 - d. Bi-directional Barrier. A barrier designed to safely handle an impact from either direction.
 - e. Uni-directional Barrier. A barrier designed to safely handle an impact from only one direction, from front to rear.
3. Barrier Terminals. End treatments for roadside barriers, median barriers and transitions to other types of barriers (e.g., to bridge rails).
4. Clear Zone. The total roadside border area, starting at the edge of the traveled way, available for safe use by errant vehicles. This area may consist of a shoulder, a recoverable slope (i.e., a slope of 4H:1V or flatter), a non-recoverable slope and/or a clear runout area free of any non-crashworthy obstacles. The desired width of the clear zone is dependent upon traffic volume, speed and roadside geometry. SCDOT generally uses a maximum clear zone distance of 30 feet; however, more clearance may be used when hazards are introduced by the project.
5. Concrete Median Barrier (CMB). A rigid barrier constructed in a median that can accommodate most vehicular impacts without penetration.
6. Crashworthy. A feature that has been proven acceptable for use under specified conditions either through crash testing or in-service performance.
7. Critical Parallel Slope. Fill sections with fill slopes steeper than 3H:1V that cannot be safely traversed by a run-off-the-road vehicle. Depending on the encroachment conditions and the reaction of the driver, a vehicle on a critical slope may overturn.

8. End Treatments. The designed modification of the end of a roadside or median barrier.
9. Experimental System. A roadside barrier, end terminal or impact attenuator that has performed satisfactorily in full-scale crash tests but has not been installed in sufficient locations or exposed to traffic for a sufficient time to demonstrate satisfactory in-service performance.
10. Fill Slope. Slopes extending outward and downward from the shoulder hinge point to intersect the natural ground line.
11. Foreslope. The side slope in a cut section created by connecting the shoulder, downward and outward, to the ditch bottom.
12. Gating. A term used to describe barrier end treatments that are designed to allow controlled penetration by an impacting vehicle.
13. Gore. The location where one or more lanes of the road separate from the previous direction of travel. An example is where a ramp separates from the main line of a freeway.
14. Guardrail. A barrier designed to redirect a vehicle. These can be further determined as follows:
 - a. Steel Beam (W-Beam) Guardrail. SCDOT standard steel beam guardrail system with two corrugations. A strong post W-beam guardrail system is designated as SGR04.
 - b. Thrie Beam Guardrail. SCDOT standard steel beam guardrail system with three corrugations to be used where a maximum rail deflection of 2 feet can be tolerated. A strong post thrie beam guardrail system is designated as SGR09.
 - c. Tubular Beam Guardrail. Two thrie beam sections welded back to back to be used as a bridge railing retrofit. Use only at special locations.
15. Impact Angle. For a longitudinal barrier, the angle between a tangent to the face of the barrier and a tangent to the vehicular path at impact. For an impact attenuator, it is the angle between the axis of symmetry of the impact attenuator and a tangent to the vehicular path at impact.
16. Impact Attenuator (Crash Cushion). A device that prevents an errant vehicle from impacting fixed objects by gradually decelerating the vehicle to a safe stop or by redirecting the vehicle away from the obstacle.

17. Length of Need. Total length of a longitudinal barrier, measured with respect to the centerline of roadway, needed to shield an area of concern. The length of need is measured to the last point of full-strength rail.
18. Longitudinal Barrier. A barrier whose primary function is to prevent penetration and to safely redirect an errant vehicle away from a roadside or median obstacle.
19. Median Barrier. A longitudinal barrier used to prevent an errant vehicle from crossing the median of a divided highway thereby preventing head-on collisions between opposing traffic.
20. NCHRP 230. National Cooperative Highway Research Program Report No. 230, outlines test and evaluation criteria for highway safety devices, which was used prior to the publication of NCHRP 350.
21. NCHRP 350. The FHWA established October 1, 1998, as the deadline for implementing hardware that has been crash tested to the criteria in NCHRP Report 350. Exceptions were made for work zone crash cushions, including truck-mounted attenuators and temporary concrete barriers. These devices must have met NCHRP 350 by October 1, 2002.
22. Non-Gating. Characteristic of a crash cushion or an end terminal that would redirect an impacting vehicle along its entire length.
23. Non-Proprietary. Generic (can be made by multiple companies).
24. Non-Recoverable Parallel Slope. Slopes which can be safely traversed but upon which an errant vehicle is unlikely to recover and will continue down to the bottom. Embankment slopes between 3H:1V and 4H:1V may be considered traversable but non-recoverable if they are smooth and free of fixed objects.
25. Non-Redirective. A descriptive term which indicates that the roadside safety device will not redirect an impacting vehicle but will, rather, "capture" the vehicle (e.g., sand barrels) or allow the vehicle to pass through (e.g., breakaway sign supports).
26. Operational System. A roadside barrier, end terminal or crash cushion which has performed satisfactorily in full-scale crash tests and has demonstrated satisfactory in-service performance.
27. Parallel Slopes. Fill and backslopes for which the toe runs approximately parallel to the roadway.
28. Pocketing. The potential for a vehicle impacting a redirective device to undergo relatively large lateral displacements within a relatively short longitudinal distance.

29. Proprietary. Made by one company only.
30. Recoverable Parallel Slope. Slopes which can be safely traversed and upon which a motorist has a reasonable opportunity to regain control of the vehicle. Fill slopes 4H:1V and flatter are generally considered recoverable.
31. Redirective. A term which indicates that the roadside safety device is designed to redirect an impacting vehicle approximately parallel to the longitudinal axis of the device.
32. Roadside Barrier. A longitudinal barrier, such as guardrail, concrete barrier, etc., used to shield roadside obstacles or non-traversable terrain features.
33. Roadside Hazards. A general term to describe roadside features that cannot be safely impacted by a run-off-the-road vehicle. Roadside hazards include both fixed objects and non-traversable roadside features (e.g., rivers).
34. Roadway. The portion of a highway for vehicular use, including shoulders (shoulder break to shoulder break).
35. Shy Distance. The distance from the edge of traveled way beyond which a roadside object will not be perceived as an obstacle by the typical driver, to the extent that the driver will change vehicular placement or speed.
36. Shy Line Offset. The distance from the edge of the traveled way, beyond which a roadside object will not be perceived as hazardous and result in a motorist's reducing speed or changing vehicle position on the roadway.
37. Side Slope. A ratio used to express the steepness of a slope adjacent to the roadway. The ratio is expressed as horizontal to vertical (H:V).
38. Sloping Curb. A longitudinal element placed at the roadway edge for delineation, to control drainage, to control access, etc. Sloping curbs have a height of 6 inches or less with a face no steeper than 1H to 3V.
39. Toe of Slope. The intersection of the fill slope, foreslope or backslope with the natural ground line or ditch bottom.
40. Top of Slope (Cut). The intersection of the backslope with the natural ground line.
41. Transverse Slopes. Fill slopes for which the toe runs approximately perpendicular to the flow of traffic on the major roadway. Transverse slopes are typically formed by intersections between the mainline and driveways, median crossovers or side roads.
42. Traveled Way. The portion of the roadway for the movement of vehicles, not including shoulders and auxiliary lanes.

43. Vertical Curb. A longitudinal element, typically concrete, placed at the roadway edge to provide delineation, to control drainage, to control access, etc. Vertical curbs range in height between 6 and 12 inches with a face steeper than 1H to 6V.
44. Warrant. The criteria by which the need for a safety treatment or improvement can be determined.

14.3 ROADSIDE CLEAR ZONES

14.3.1 Background

The clear zone widths presented in this *Manual* are based on limited empirical data which has been extrapolated to a wide range of conditions. Therefore, the distances imply a degree of accuracy that does not exist. They do, however, provide a good frame of reference for making decisions on providing a safe roadside area. Each application of the clear zone distance must be evaluated individually, and the designer must exercise good judgment.

When using the recommended clear zone distances, the designer should consider the following:

1. Project Scope of Work. The clear zone distances in Section 14.3 apply to all freeway projects and to new construction/reconstruction projects on non-freeways.
2. Context. As a general statement, the use of an appropriate clear zone distance is a compromise between maximum safety and minimum construction costs. If a formidable obstacle lies just beyond the clear zone, it may be appropriate to remove or shield the obstacle if costs are reasonable. Conversely, the clear zone should not be achieved at all costs. Limited right of way (see Item 4 below) or unacceptable construction costs may lead to installation of a barrier or perhaps no protection at all.
3. Boundaries. The designer should not use the clear zone distances as boundaries for introducing roadside hazards (e.g., bridge piers, non-breakaway sign supports, utility poles, landscaping features). Place these elements as far from the traveled way as practical.
4. Types of Roadside Hazards. The designer should distinguish between roadside hazards that are essential to the function of the highway (e.g., bridge piers, traffic signs) and those that are ancillary to the function of the highway (e.g., landscaping features). For those hazards that fall into the latter category, a greater clear zone distance is appropriate.
5. Right of Way. Even for new construction/reconstruction projects, the availability of right of way may be a serious project issue. The acquisition of additional right of way solely to provide the clear zone distance may not be cost effective. If, on the other hand, the right of way width exceeds the design clear zone, this offers an opportunity to increase safety by removing all hazards within the right of way.

14.3.2 Clear Zone Values

Figure 14.3A presents clear zone distances for design. The following discusses the use of Figure 14.3A to determine the applicable clear zone.

14.3.2.1 Speed

The designer will use the design speed for the facility to determine the applicable clear zone from Figure 14.3A.

14.3.2.2 Design Year

For all new construction/reconstruction projects, the design year will be 20 years from the anticipated date of construction completion.

14.3.2.3 Traffic Volumes

As indicated in Figure 14.3A, the ADT influences the clear zone value. The figure is divided into ranges of traffic volumes and ranges of recommended clear zones. In general, the higher clear zones apply to the higher traffic volumes.

14.3.2.4 Side Slopes

The roadway side slope will influence the recommended clear zone distance from Figure 14.3A. Figure 14.3B presents a schematic of the general side slope configurations, which may be:

- a fill slope,
- a section with a roadside ditch, or
- a section where the toe of the backslope is adjacent to the edge of shoulder.

Note: The values in Figure 14.3A for backslopes only apply to a section as illustrated in Figure 14.3B(c) (e.g., valley gutter section); they do not apply where a roadside ditch is present. See Chapter 13 for more discussion.

Many variables influence the selection of a clear zone distance for the various side slope configurations. Sections 14.3.3 and 14.3.4 discuss side slope configuration in detail.

Design Speed	Design Year ADT	Fill/Foreslopes		Backslopes		
		6H:1V or Flatter	5H:1V to 4H:1V	3H:1V	5H:1V to 4H:1V	6H:1V or Flatter
40 mph or less	Under 750	7 – 10	7 – 10	7 – 10	7 – 10	7 – 10
	750 – 1500	10 – 12	12 – 14	10 – 12	10 – 12	10 – 12
	1500 – 6000	12 – 14	14 – 16	12 – 14	12 – 14	12 – 14
	Over 6000	14 – 16	16 – 18	14 – 16	14 – 16	14 – 16
45 – 50 mph	Under 750	10 – 12	12 – 14	8 – 10	8 – 10	10 – 12
	750 – 1500	14 – 16	16 – 20	10 – 12	12 – 14	14 – 16
	1500 – 6000	16 – 18	20 – 26	12 – 14	14 – 16	16 – 18
	Over 6000	20 – 22	24 – 28	14 – 16	18 – 20	18 – 20
55 mph	Under 750	12 – 14	14 – 18	8 – 10	10 – 12	10 – 12
	750 – 1500	16 – 18	20 – 24	10 – 12	14 – 16	16 – 18
	1500 – 6000	20 – 22	24 – 30	14 – 16	16 – 18	20 – 22
	Over 6000	22 – 24	26 – 32*	16 – 18	20 – 22	22 – 24
60 mph	Under 750	16 – 18	20 – 24	10 – 12	12 – 14	14 – 16
	750 – 1500	20 – 24	26 – 32*	12 – 14	16 – 18	20 – 22
	1500 – 6000	26 – 30	32 – 40*	14 – 18	18 – 22	24 – 26
	Over 6000	30 – 32*	36 – 44*	20 – 22	24 – 26	26 – 28
65 – 70 mph	Under 750	18 – 20	20 – 26	10 – 12	14 – 16	14 – 16
	750 – 1500	24 – 26	28 – 36*	12 – 16	18 – 20	20 – 22
	1500 – 6000	28	34 – 42*	16 – 20	22 – 24	26 – 28
	Over 6000	30 – 34*	38 – 46*	22 – 24	26 – 30	28 – 30

* Where a site-specific investigation indicates a high probability of continuing crashes, or such occurrences are indicated by crash history, the designer may provide clear zone distances greater than the clear zones shown in Figure 14.3A. Clear zones may be limited to 30 feet for practicality and to provide a consistent roadway template if previous experience with similar projects or designs indicates satisfactory performance.

- Notes:
1. All distances are in feet and are measured from the edge of the traveled way.
 2. For clear zones, the "Design Year ADT" will be the total ADT for both directions of travel for the design year. This applies to both divided and undivided facilities. Traffic volumes will be based on a 20-year projection from the anticipated date of construction completion.
 3. The values in the figure apply to tangent sections of highway. See the discussion in [Section 14.3.2.5](#) for possible adjustments on horizontal curves.
 4. The values in the figure apply to all facilities without curbs. See [Section 14.3.2.6](#) for curbed sections.
 5. Clear zone distances for the 3H:1V fill slope have been omitted, because it is not typically used in South Carolina. See the AASHTO Roadside Design Guide for clear zone calculations where a 3H:1V fill slope is used.

RECOMMENDED CLEAR ZONE DISTANCES (New Construction/Reconstruction)

Figure 14.3A

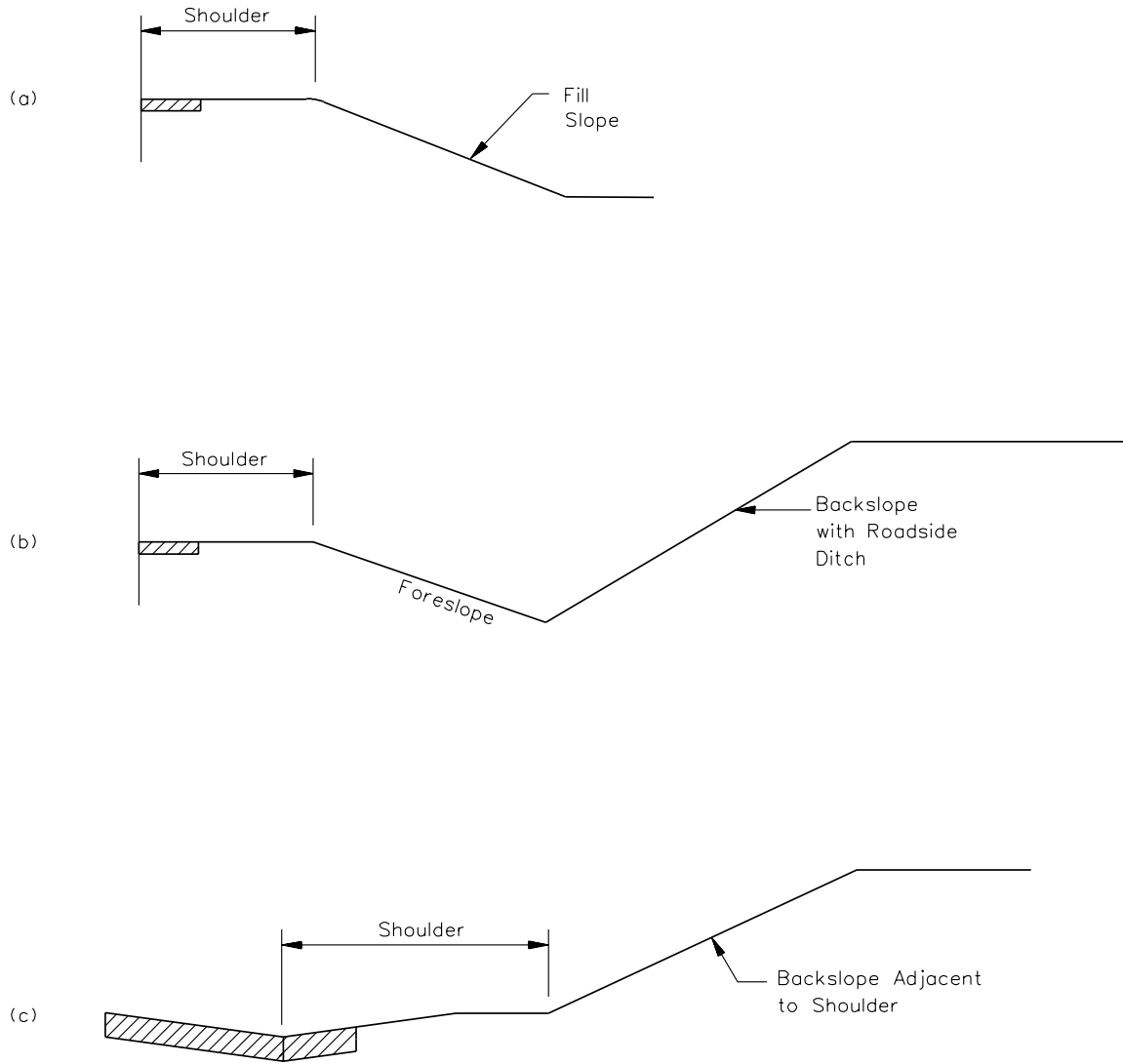

SIDE SLOPE CONFIGURATIONS

Figure 14.3B

14.3.2.5 Alignment (Horizontal Curve Adjustment)

The clear zone values in [Figure 14.3A](#) assume a tangent alignment. Horizontal curves may increase the angle of departure from the roadway and thus increase the distance the vehicle will need to recover. Desirably and if practical, the designer should adjust the tangent values to provide wider clear zones on the outside of horizontal curves. [Figure 14.3C](#) provides recommended adjustments for clear zones on horizontal curves. Where adjustments are determined to be cost effective, [Figure 14.3D](#) illustrates the application of the clear zone adjustment on a curve.

* * * * *

Example 14.3(1)

Given: Design Speed = 55 miles per hour
 Design ADT = 3000
 Horizontal curve with a radius of 2000 feet
 Flat side slope

Problem: Find the clear zone adjusted for the horizontal curve.

Solution: From [Figure 14.3A](#), the minimum clear zone on the tangent (CZ_t) = 20 feet.

 From [Figure 14.3C](#), the curve correction factor (K_{CZ}) = 1.2
 The clear zone for the curve (CZ_c) = (20)(1.2) = 24 feet

 The transition length (equal to the runout length (L_R)) from [Figure 14.6D](#) = 345 feet. See [Figure 14.3D](#) for application.

* * * * *

14.3.2.6 Facilities with Curbs

Because substantial development typically occurs in areas with curbs, it is often impractical to remove or shield all obstacles within the clear zone. Because curbs do not have a significant redirection capability, obstructions behind a curb should be located at or beyond the minimum clear zone distances shown in [Figure 14.3A](#). In many instances, it will not be feasible to obtain the recommended clear zone distances on existing facilities. On new construction where minimum recommended clear zones cannot be provided, fixed objects should be located as far from traffic as practical on a project-by-project basis, desirably 5.5 feet, but in no case closer than 1.5 feet from the face of the curb.

Radius (ft)	Design Speed (mph)						
	≤40	45	50	55	60	65	70
2860	1.1	1.1	1.1	1.2	1.2	1.2	1.3
2290	1.1	1.1	1.2	1.2	1.2	1.3	1.3
1910	1.1	1.2	1.2	1.2	1.3	1.3	1.4
1640	1.1	1.2	1.2	1.3	1.3	1.4	1.5
1430	1.2	1.2	1.3	1.3	1.4	1.4	
1270	1.2	1.2	1.3	1.3	1.4	1.5	
1150	1.2	1.2	1.3	1.4	1.5		
950	1.2	1.3	1.4	1.5	1.5		
820	1.3	1.3	1.4	1.5			
720	1.3	1.4	1.5				
640	1.3	1.4	1.5				
570	1.4	1.5					
380	1.5						

Notes:

1. Adjustments apply to the outside of a horizontal curve only.
2. No adjustments are warranted for curve radii greater than 2860 feet.
3. The applicable clear zone distance on a horizontal curve is calculated by:

$$CZ_c = (K_{cz})(CZ_t)$$

where: CZ_c = clear zone on a curve, feet

K_{cz} = curve adjustment factor

CZ_t = clear zone on a tangent section from [Figure 14.3A](#), feet

Round calculated CZ_c up to the next highest 1-foot increment.

4. For curve radii intermediate in the figure, use a straight-line interpolation.
5. See [Figure 14.3D](#) for the application of CZ_c to the roadside around a curve.

CLEAR ZONE ADJUSTMENT FACTORS FOR HORIZONTAL CURVES (K_{cz})

Figure 14.3C

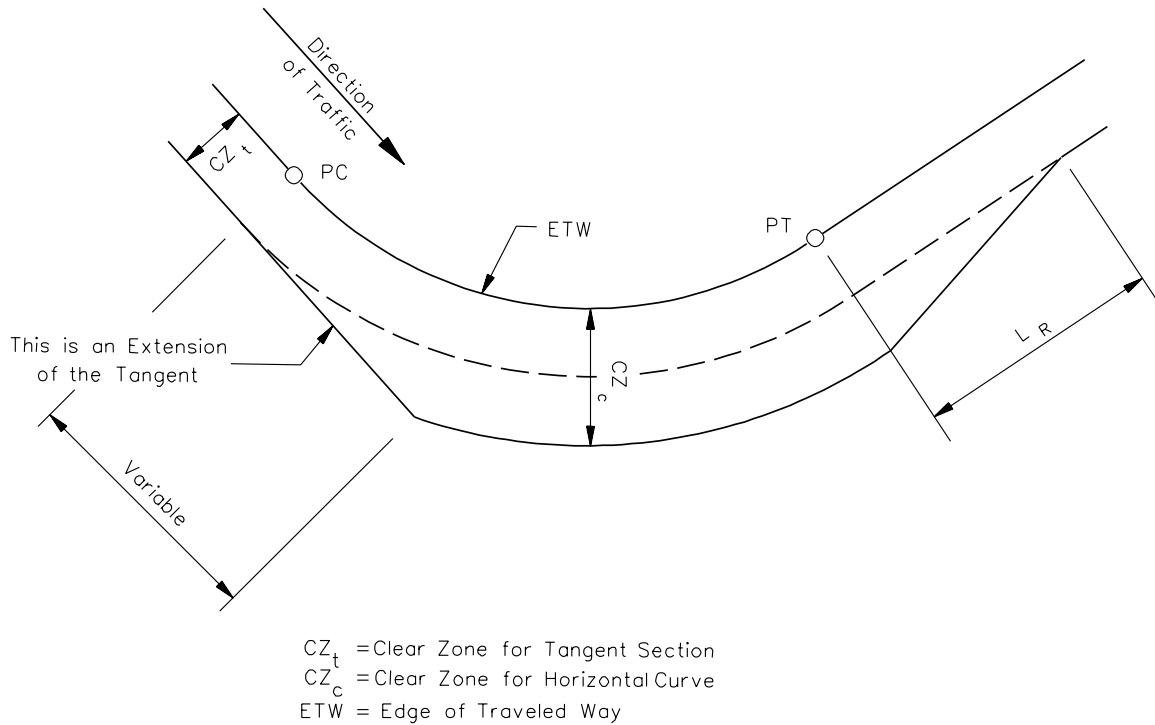

Note: See [Figure 14.6D](#) for L_R distances.

APPLICATION OF HORIZONTAL CURVE ADJUSTMENT

Figure 14.3D

Where sidewalks are adjacent to the curb (i.e., there is no buffer area), locate all appurtenances behind the sidewalk, if practical. In addition, the designer must insure that sufficient sidewalk width is available between appurtenances and the curb to meet the ADA clearance criteria; see [Section 17.1](#).

As further discussed in [Section 14.4](#), general Department policy is that roadside barriers are typically not warranted to shield hazards outside of the calculated clear zone. This also applies to hazards outside of the obstruction-free area behind curbs. However, special conditions may dictate otherwise. For example, a barrier may be warranted approaching a bridge rail on urban facilities with curbs. Other exceptions, as determined on a case-by-case basis, may apply.

14.3.2.7 Lane Width

The clear zone distances in [Figure 14.3A](#) are, theoretically, predicated upon a 12-foot lane width. However, they will be used for any lane width.

14.3.2.8 Auxiliary Lanes

Auxiliary lanes are defined as any lanes beyond the basic through travel lanes which are intended for use by vehicular traffic for specific functions. These include turn lanes at intersections, truck-climbing lanes, weaving lanes, acceleration/deceleration lanes at interchanges, etc. The clear zone for auxiliary lanes will be determined as follows:

1. Turn Lanes at Intersections. Where the intersection is without curbs, clear zones will be determined based on the design speed and traffic volumes associated with the through travel lanes (i.e., the presence of the turn lane is ignored when determining clear zones), provided that a minimum 10-foot clear zone is maintained beyond the edge of the shoulder. Where the intersection is curbed, the criteria in [Section 14.3.2.6](#) will apply (i.e., the minimum obstruction-free zone is 1.5 feet from the gutter line).
2. Auxiliary Lanes Adjacent to Mainline. Clear zone applications for climbing lanes, acceleration/deceleration lanes, weaving lanes, etc., will be as follows. Two independent clear zone determinations are necessary. First, the designer calculates the clear zone from the edge of the through traveled way based on the total traffic volume, including the auxiliary lane volume. Second, the designer calculates the clear zone from the edge of the auxiliary lane based on the traffic volume in the auxiliary lane. The clear zone distance which extends the farthest will apply.

14.3.3 Fill Slopes

Figure 14.3B illustrates the basic configuration for fill slopes. Section 14.2 presents definitions of parallel fill slopes which apply to clear zone determinations. Figure 14.3E presents schematics for these definitions, and the following discusses the clear zone application in conjunction with Figure 14.3A.

14.3.3.1 Recoverable Fill Slopes

For parallel fill slopes 4H:1V and flatter (Figure 14.3E(a)), the recommended clear zone distance can be determined directly from Figure 14.3A.

14.3.3.2 Critical Fill Slope

Fill slopes steeper than 3H:1V are critical (Figure 14.3E(b)). These typically require a barrier and, therefore, there is no clear zone application. See Section 14.4. SCDOT does not typically use a 3H:1V fill slope.

14.3.4 Roadside Ditches

Ditch sections, as illustrated in Figure 14.3F, are typically constructed in roadside cut sections without curbs. The applicable clear zone across a ditch section will depend upon the foreslope, the backslope, the horizontal location of the toe of the backslope and various highway factors. The designer will use the following procedure to determine the recommended clear zone distance:

1. Check Foreslope. Use Figure 14.3A to determine the clear zone based on the ditch foreslope.
2. Check Location of the Toe of Backslope. Based on the distance from Step 1, determine if the toe of the backslope is within the clear zone. The toe of backslope is defined as the point at which the ditch ends and the (uniform) backslope begins. If the toe is at or beyond the clear zone, then the designer usually need only consider roadside hazards within the clear zone on the foreslope or within the ditch. If the toe is within the clear zone, the designer should evaluate the practicality of relocating the toe of backslope. If the toe of backslope will remain within the clear zone, Step 3 will apply to ditch sections in earth cuts.

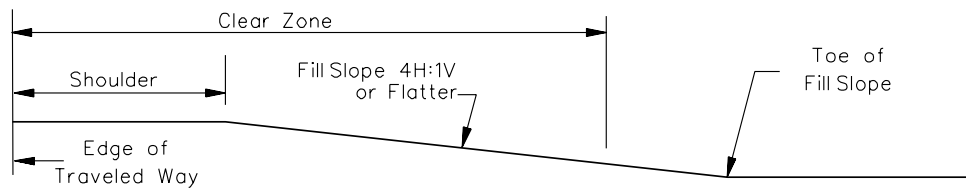
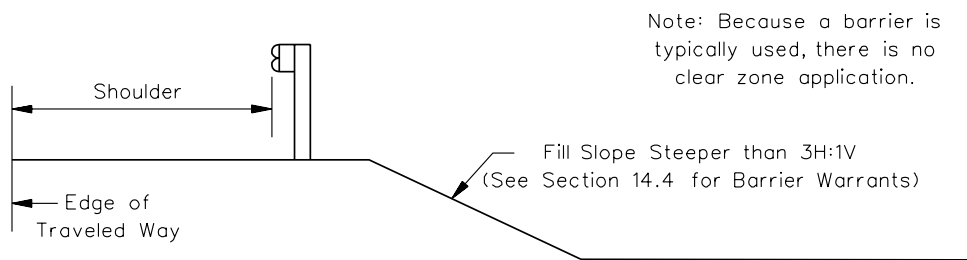
(a) RECOVERABLE PARALLEL SLOPE(b) CRITICAL PARALLEL SLOPE

**CLEAR ZONE APPLICATION FOR FILL SLOPES
(Facilities Without Curbs)**

Figure 14.3E

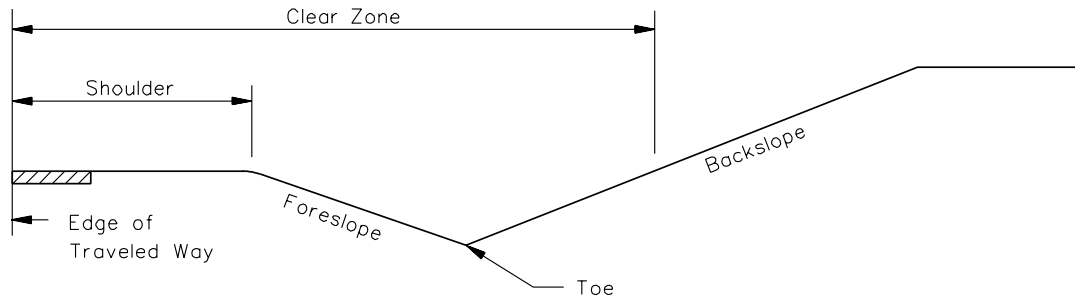

CLEAR ZONE APPLICATION FOR ROADSIDE DITCHES

Figure 14.3F

3. Determine Clear Zone on Backslope (Earth Cuts). If the toe of the backslope is within the clear zone distance from [Step 1](#) above, a clear zone should be provided on the backslope. This clear zone will be a distance beyond the toe of backslope as follows:
 - a. Calculate the percentage of the clear zone (from [Step 1](#)) available to the toe of the backslope.
 - b. Subtract this percentage from 100 percent and multiply the results by the clear zone for the backslope in [Figure 14.3A](#).
 - c. Add the available clear zone to the toe of the backslope to the value determined in Step 3b. This yields the required clear zone from the edge of traveled way to a point on the backslope.
4. Clear Zones (Rock Cuts). In rock cuts with steep backslopes, no clear zone is required beyond the toe of backslope. However, the rock cut should be relatively smooth to minimize the hazards of vehicular snagging. If the face of the rock is rough or rock debris is present, a barrier may be warranted.

* * * * *

Example 14.3(2) (Ditch Section)

Given: Design ADT = 7000
 V = 60 miles per hour
 Foreslope = 6H:1V
 Ditch Width = 4 feet
 Backslope = 4H:1V

Toe of backslope is 20 feet from edge of traveled way.
See [Figure 14.3G](#).

Problem: Determine the clear zone application across the ditch section.

Solution: Using the procedure in [Section 14.3.4](#):

1. Check Foreslope. [Figure 14.3A](#) yields a clear zone of 30 feet for a 6H:1V foreslope.
2. Check Location of Toe of Backslope. The toe of backslope is within the clear zone. Therefore, Step 3 applies.
3. Determine Clear Zone on Backslope (Earth Cuts). Using the procedure in [Step 3](#):
 - a. The percentage of the clear zone available to the toe of backslope is $20/30 = 67$ percent.
 - b. Subtracting this percentage from 100 percent yields: $100 - 67 = 33$ percent. [Figure 14.3A](#) yields a minimum clear zone on a 4H:1V backslope of 24 feet. Multiplying this by 33 percent yields: $(24)(0.33) = 8$ feet.
 - c. Adding 8 feet to 20 feet yields 28 feet. Therefore, the total clear zone is 28 feet from the edge of traveled way or 8 feet up the 4H:1V backslope.

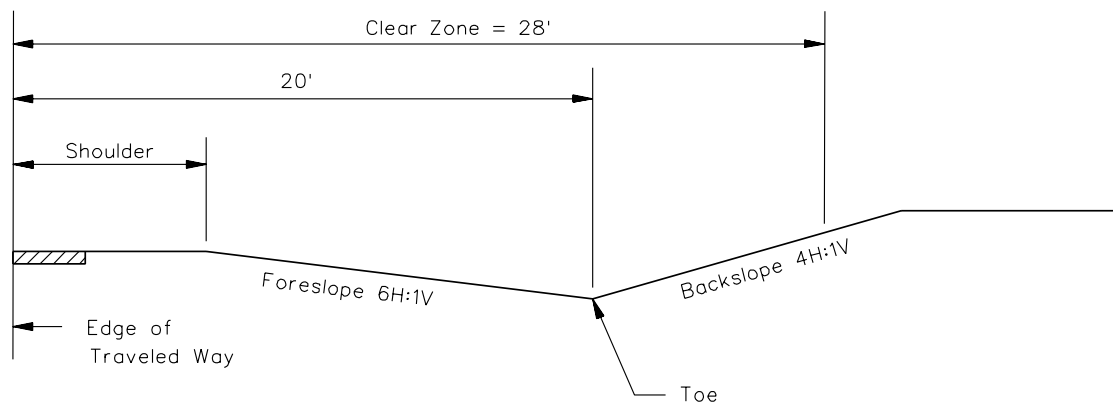

**CLEAR ZONE AT DITCH SECTION
(Example 14.3(2))**

Figure 14.3G

14.4 ROADSIDE BARRIER WARRANTS

14.4.1 Range of Treatments

If a roadside hazard is within the clear zone, the designer should select the treatment which is judged to be the most practical and cost-effective for the site conditions. The range of treatments include:

- eliminate the hazard (e.g., flatten embankment, remove rock outcroppings);
- relocate the hazard;
- where applicable, make the hazard breakaway (e.g., sign posts, luminaire supports);
- shield the hazard with a roadside barrier;
- delineate the hazard; or
- leave unshielded.

14.4.2 Warrant Methodologies

In many cases, the alternatives for treating a roadside hazard may be narrowed to two choices — install a barrier or leave unshielded. Whether objectively or subjectively, the decision will be based upon the traffic volumes, roadway geometry, proximity of the hazard to the traveled way, nature of the hazard, installation costs and, where applicable, crash experience. The following briefly discusses the Department's decision-making methods for barrier warrants.

14.4.2.1 Department Policy

For specific applications, the Department has adopted policies on warrants for roadside barriers. These are documented throughout Chapter 14.

14.4.2.2 Engineering Judgment Method

Barrier warrants have been typically determined based on engineering judgment. With this approach, the designer first analyzes the site by a “relative severity” assessment — which is the greater hazard, the roadside barrier or the roadside hazard? Next, the designer subjectively evaluates the site-specific parameters (e.g., traffic volumes, design speed, location of hazard, barrier installation costs) to determine if a barrier installation is a reasonable and practical solution. If yes, a barrier is warranted; if no, then the unshielded alternative is selected. For example, it would probably not be practical to install a barrier to shield an isolated point obstacle, such as a tree, located near the edge of the clear zone. The designer must realize that a barrier is also a

hazard and, if a clear decision cannot be reached, the general rule of "when in doubt, leave it out" should apply.

14.4.2.3 Cost-Effectiveness Method

On a case-by-case basis, the designer may use an approved cost-effectiveness methodology to determine roadside barrier warrants. This provides an objective means to analyze the myriad of factors which impact roadside safety, and it will, in theory, allow the Department to allocate its resources to maximize the safety benefit to the traveling public. The designer must use a cost-effectiveness methodology which has been approved by the Department. Currently, SCDOT accepts the cost-effectiveness methodology Roadside Safety Analysis Program (RSAP) presented in Appendix A of the AASHTO *Roadside Design Guide*. RSAP may be used in one of two basic applications:

1. General Warrants. RSAP may be used to develop general barrier warrants to apply to specific roadside conditions.
2. Site Specific. RSAP may be used to evaluate any specific site by inputting the data for that location (e.g., traffic volumes, design speed, proximity to traveled way).

14.4.3 Roadside Hazards

[Section 14.3](#) presents the recommended clear zone distances for various highway conditions. These distances should be free of any fixed or non-traversable hazards. In general, barrier warrants are based on the relative severity between impacting the barrier and impacting the obstacle.

Examples of roadside hazards include:

- non-breakaway sign supports, non-breakaway luminaire supports, traffic signal poles and railroad signal poles;
- concrete footings, etc., extending more than 4 inches above the ground;
- bridge piers and abutments at underpasses and bridge parapet ends;
- retaining walls and culvert headwalls;
- trees with diameters greater than 4 inches at maturity;
- rough rock cuts;
- large boulders;
- critical parallel slopes (i.e., embankments);
- streams or permanent bodies of water (i.e., where the depth of water ≥ 2 feet);
- non-traversable ditches;
- utility poles or towers;

- drainage appurtenances; and
- steep transverse slopes.

Shielding obstacles located just outside the clear zone may be appropriate, especially for features installed by the Department or sites that have an adverse crash history. For example, shielding a bridge end location just outside the clear zone may be justified, due to the potential severity of the crash and running speeds higher than the design speeds.

14.4.4 Embankments

The severity of the roadside embankment depends upon the rate of fill slope and the height of fill. [Figure 14.4A](#) presents barrier warrants for embankments.

14.4.5 Transverse Slopes

Where the mainline highway intersects a driveway, side road or median crossing, a slope transverse to the mainline will be present. See [Figure 14.4B](#). In general, transverse slopes should be as flat as practical. [Figure 14.4C](#) presents SCDOT criteria for transverse slopes within the clear zone based on type of facility and design speed.

[Figure 14.4C](#) presents both desirable (i.e., flatter) and acceptable (i.e., steeper) transverse slopes. The application at a specific site will depend upon an evaluation of many factors, including:

- height of transverse embankment,
- traffic volumes,
- design speed,
- presence of culverts and practicality of treating the culvert end (see [Section 14.4.6](#)),
- construction costs, and
- right of way and environmental impacts.

Although the 10H:1V transverse slope may be desirable, its practicality may be limited because of drainage structures, width restrictions and maintenance problems associated with the long tapered ends of pipes or culverts.

If the criteria in [Figure 14.4C](#) cannot be met, the designer should consider the installation of a roadside barrier.

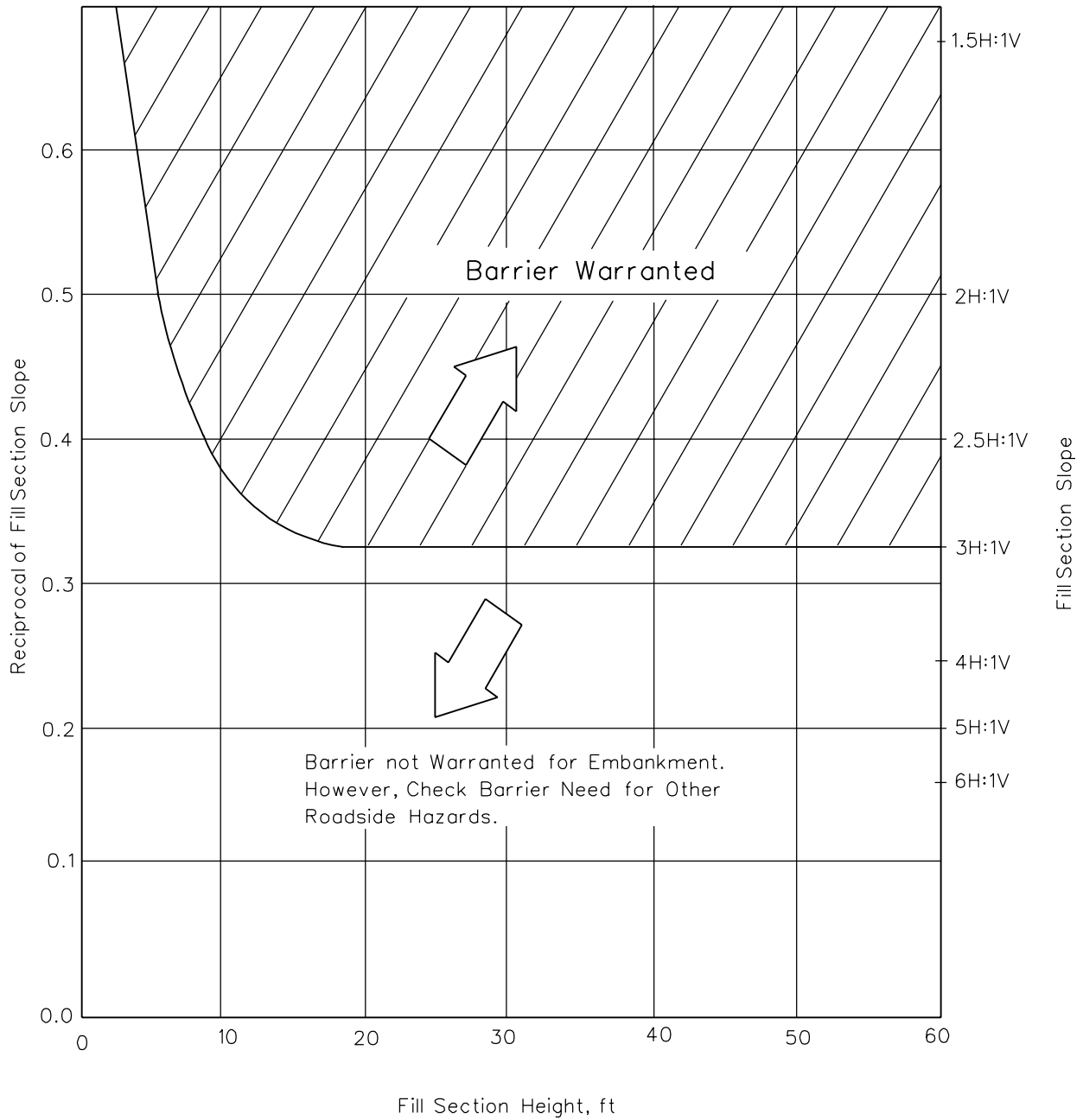

Note: Points which fall on the solid line do not warrant a barrier.

BARRIER WARRANTS FOR EMBANKMENTS

Figure 14.4A

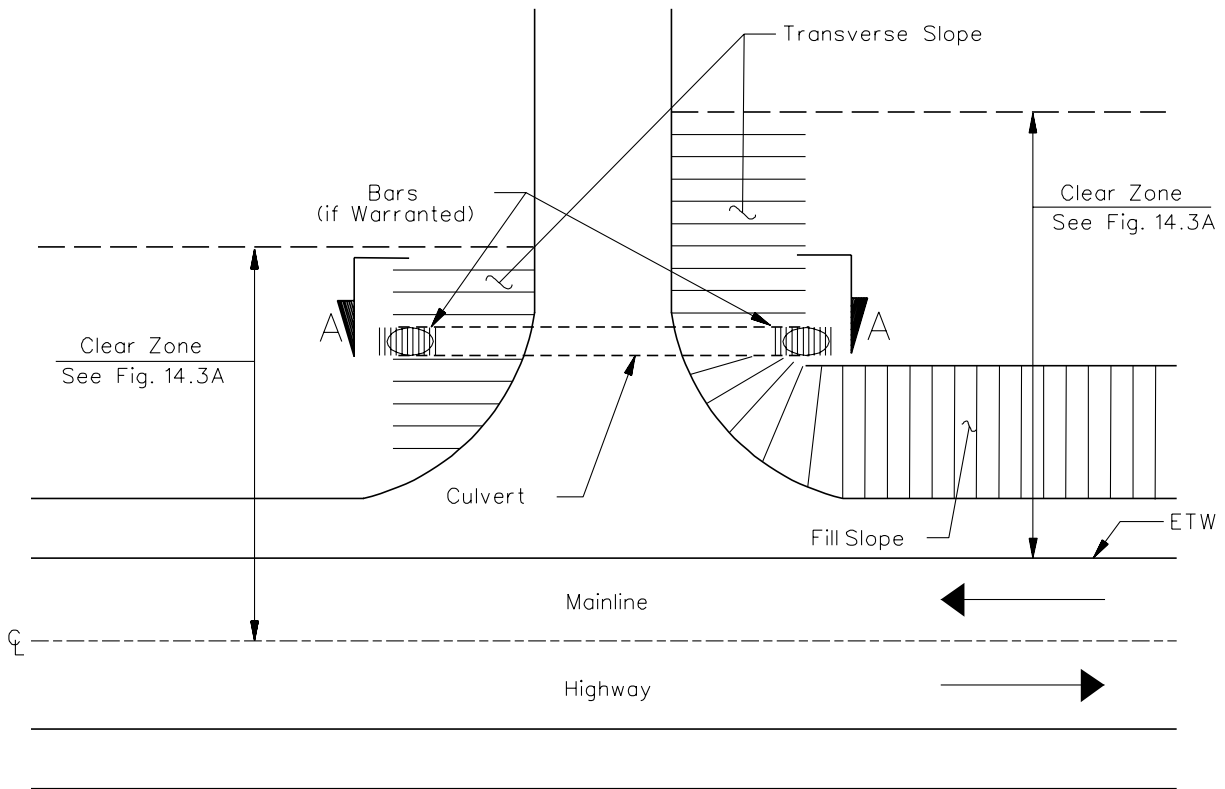

Note: On a one-way facility, the bars on the downstream side are not required.

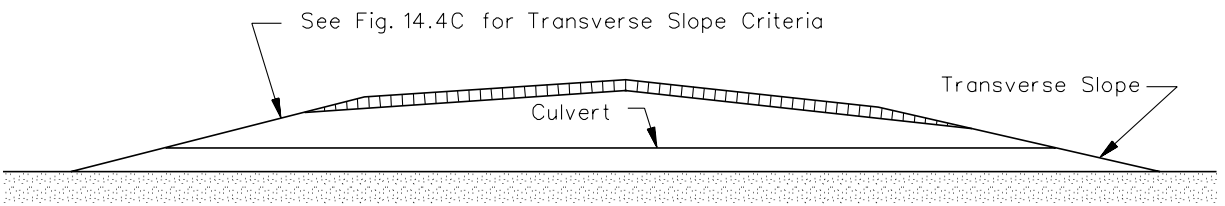

SECTION A-A

TRANSVERSE SLOPES ON A TWO-LANE, TWO-WAY ROADWAY

Figure 14.4B

Type of Facility	Desirable (H:V)	Acceptable (H:V)
Freeway	10:1	6:1
Non-Freeways ($V > 45$ mph)	10:1	6:1
Urban and Rural Low-Speed Facilities ($V \leq 45$ mph)	6:1	4:1

RECOMMENDED TRANSVERSE SLOPES

Figure 14.4C

14.4.6 Roadside Drainage Features

Effective drainage is one of the most critical elements in the design of a highway or street. However, drainage features should be designed and constructed considering their consequences on run-off-the-road vehicles. Ditches, curbs, culverts and drop inlets are common drainage system elements that should be designed, constructed and maintained considering both hydraulic efficiency and roadside safety.

In general, the following options, listed in order of preference, are applicable to all drainage features:

1. Design or modify drainage structures so they are traversable or present a minimal hazard to an errant vehicle.
2. If a major drainage feature cannot effectively be redesigned or relocated, shielding by a traffic barrier should be considered.

The South Carolina *Requirements for Hydraulic Design Studies* and [Chapter 29](#) of the *SCDOT Highway Design Manual* discuss the Department's practices for hydrology and hydraulics and for the physical design of roadside drainage structures. [Sections 14.4.6.2](#) and [14.4.6.3](#) discuss the safety design of these structures.

14.4.6.1 Curbs

Curbs are typically used to control drainage or to protect erodible soils. Curbs may pose a roadside hazard because of their potential to adversely affect a run-off-the-road vehicle. When evaluating curbs relative to roadside safety, the designer should consider the following:

1. Design Speed. In general, curbs are not desirable along high-speed roadways. However, if necessary, a sloping curb may be used. Facilities with a design speed

- of 45 miles per hour or less may use either a sloping or vertical curb. See [Chapter 21](#).
2. Roadside Barriers. The use of curbs in conjunction with a roadside barrier is discouraged. See [Section 14.6](#) and the *Roadside Design Guide* for use of barriers with curbs.
 3. Redirection. Curbs offer no safety benefits on high-speed roadways and should not be used to redirect errant vehicles.

14.4.6.2 Cross Drainage Structures

Cross drainage structures convey water beneath the roadway and are designed to, among other objectives, prevent overtopping of the roadway. However, if not properly designed, they may present a hazard to run-off-the-road vehicles. The available roadside treatments for cross culverts include:

- extend the culvert opening beyond the clear zone,
- provide a traversable end section,
- shield the culvert with a roadside barrier, or
- leave unshielded.

If an inlet/outlet of a cross drainage structure is within the clear zone, the preferred treatment is to extend the structure so that the obstacle is located beyond the clear zone. Extending the culvert may result in warping the side slopes to match the opening.

The following summarizes typical Department practices on the roadside safety treatment of cross drainage RCP, HDPE and CAP structures that will remain within the clear zone and will not be located behind a roadside barrier:

1. Round Pipes. For RCP diameters 36 inches or less, use beveled end sections as presented in the *SCDOT Standard Drawings*. Flexible pipe ends may be field cut to match the surrounding slope.
2. Pipe Arches/Elliptical Pipes. The pipe rise and span will be used, rather than the equivalent round diameter, to determine the safety treatment.
3. Bar Grates. These may be considered for all pipe applications where the end is within the clear zone. [Figure 14.4D\(a\)](#) presents a schematic of a design for grate protection of a cross drainage structure.

For box culverts and crossline pipes greater than 36 inches within the clear zone, shielding with a roadside barrier will often be the most practical application. Flared end sections may be used in lieu of beveled end sections.

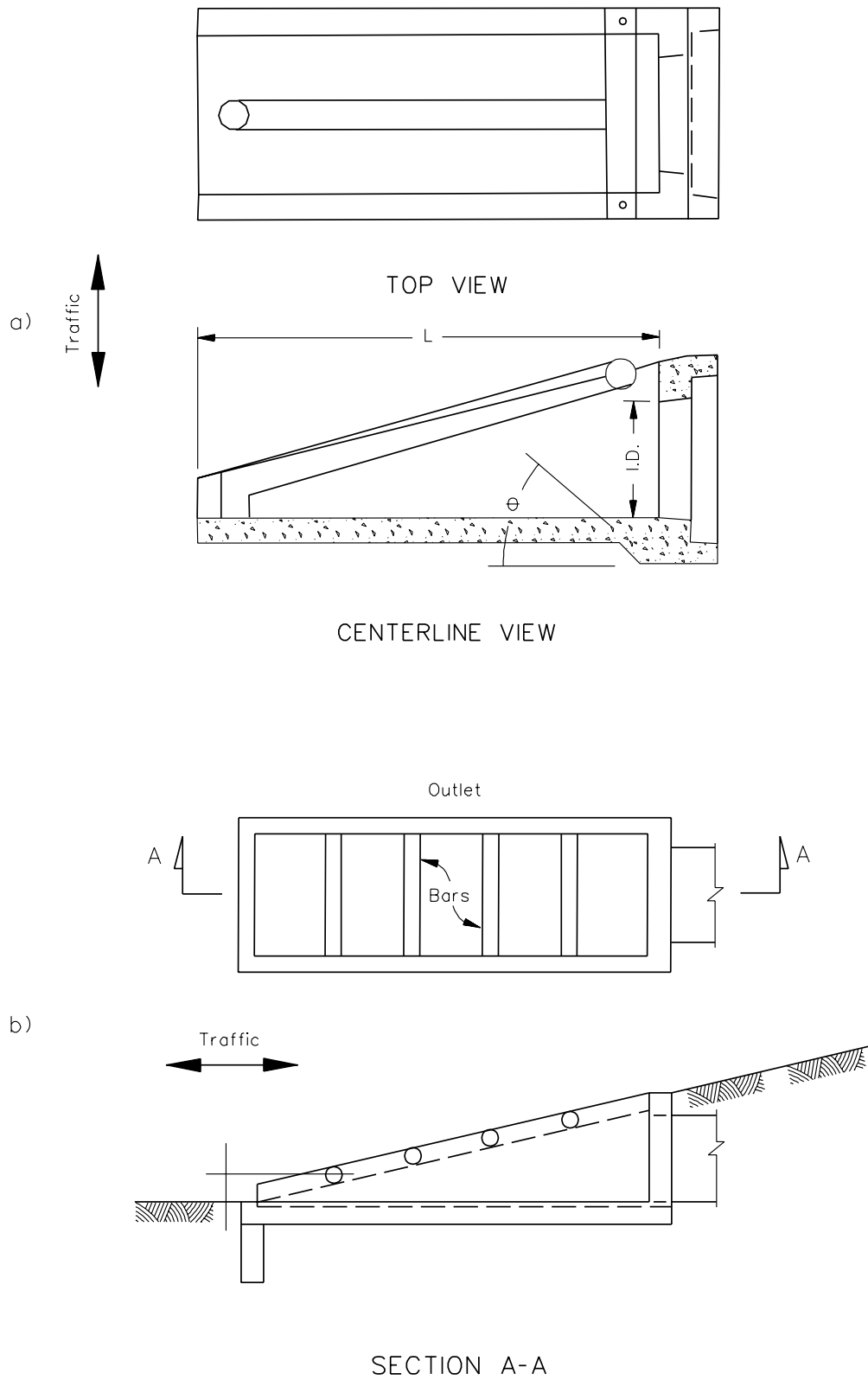

DESIGN FOR DRAINAGE STRUCTURE GRATES

Figure 14.4D

14.4.6.3 Parallel Drainage Structures

Parallel drainage culverts are those that are oriented parallel to the main flow of traffic. They are typically used under driveways, field entrances, access ramps, intersecting side roads and median crossovers. As with cross drainage structures, the designer's primary objective should be to keep the parallel drainage structure outside the mainline clear zone. Because an errant vehicle will impact the structure at approximately 90 degrees, parallel drainage structures within the clear zone represent a potential hazard. Therefore, the designer must coordinate their design with that of the surrounding transverse slope ([Section 14.4.5](#)) to minimize the hazard.

The following summarizes Department practices on the roadside safety treatment of parallel drainage structures within the clear zone:

1. Slope of Opening. The opening of the parallel drainage structure should be cut to match the slope of the surrounding (transverse) embankment. This applies to openings for approaching traffic and to departing openings that are within the clear zone of opposing traffic.
2. Pipe Diameter \leq 18 inches. For these pipe sizes, no special treatment is necessary.
3. Pipe Diameter \geq 24 inches. For these pipe sizes, the designer should consider providing bars across the opening or provide a roadside barrier if within the clear zone. [Figure 14.4D\(b\)](#) presents a schematic of a design for grate protection of a parallel drainage structure.
4. Eliminate Exposed Ends. Parallel drainage structures may be closely spaced because of frequent driveways and intersecting roads. In these locations, it may be desirable to convert the open ditch into a closed drainage system and backfill the areas between adjacent driveways. This treatment will eliminate the ditch section and the transverse embankments with pipe inlets and outlets.

14.4.7 Roadside Ditches (Earth Cuts)

[Figures 14.4E](#) and [14.4F](#) present foreslope and backslope combinations for basic ditch configurations. Cross sections which fall in the shaded region of each of the figures are considered traversable. Ditch sections which fall outside the shaded region are considered non-traversable and, if practical, should be redesigned to an acceptable cross section; however, if a redesign is not practical, a roadside barrier is typically not warranted.

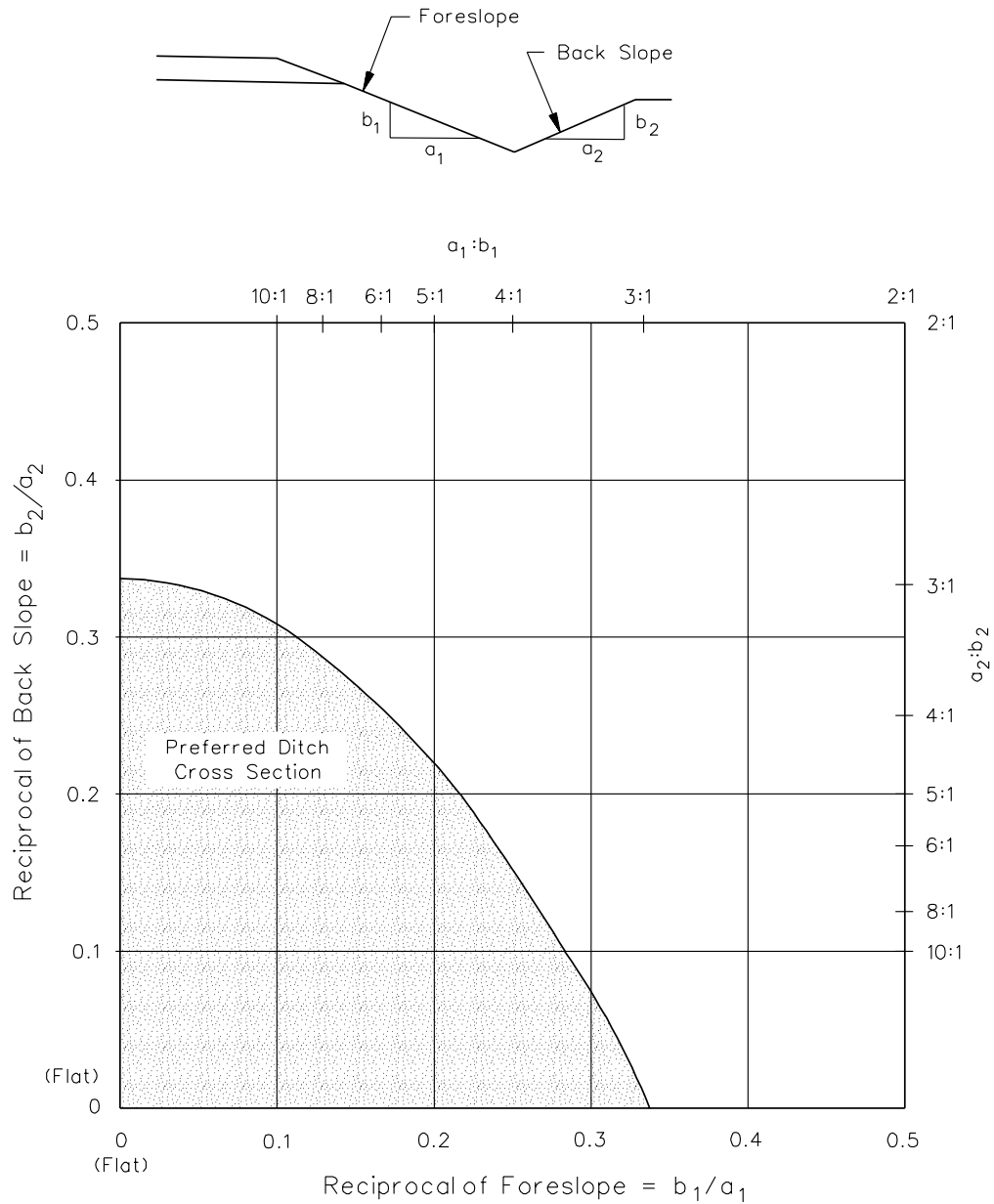

Note: This chart is applicable to all V-ditches and flat-bottom ditches with bottom widths less than 4 feet.

PREFERRED CROSS SECTIONS FOR DITCHES WITH ABRUPT SLOPE CHANGES

Figure 14.4E

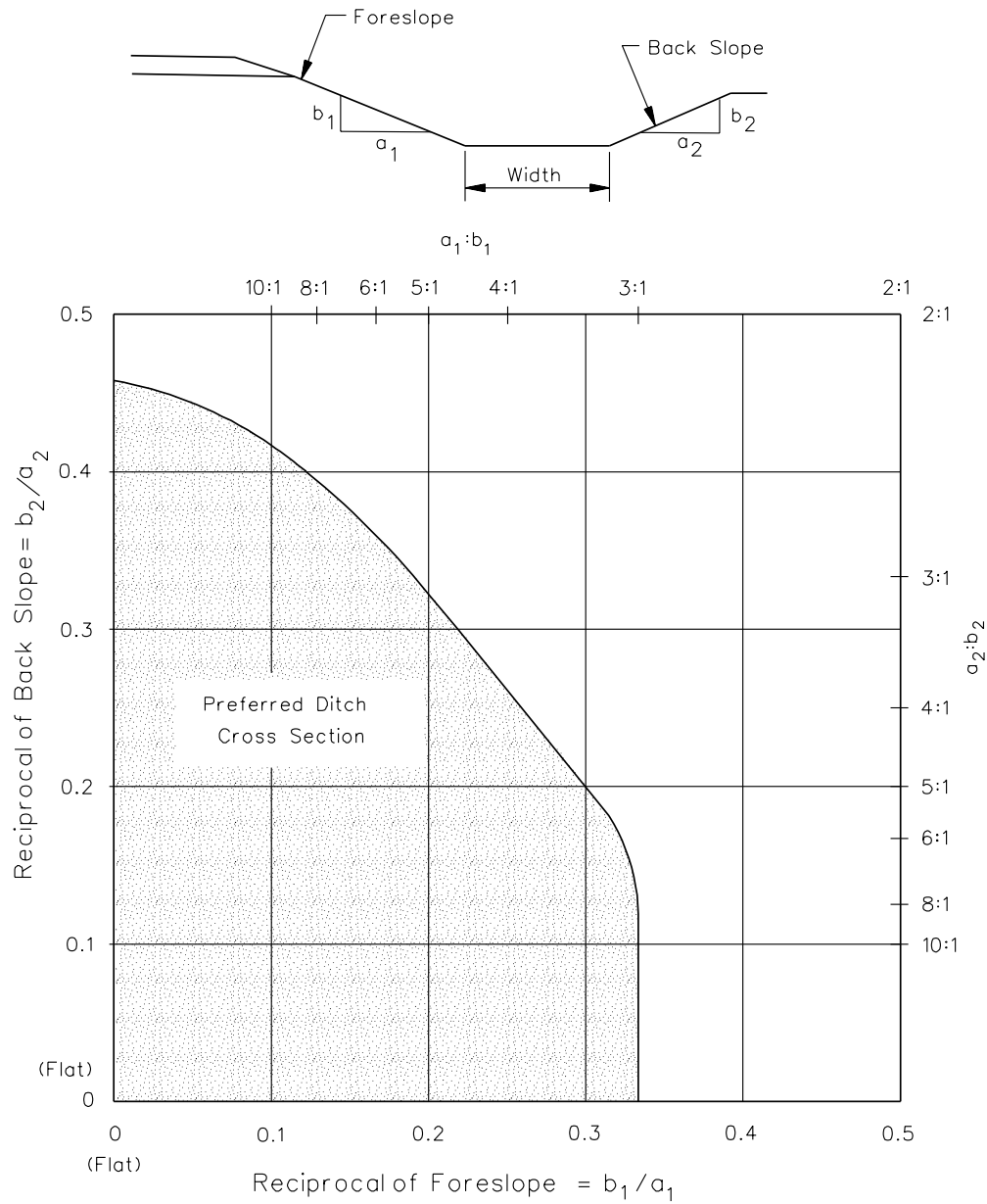

Note: This chart is applicable to flat bottom ditches with bottom widths equal to or greater than 4 feet.

PREFERRED CROSS SECTIONS FOR DITCHES WITH GRADUAL SLOPE CHANGES

Figure 14.4F

Chapters 19 through 22 present specific SCDOT criteria for the configuration of roadside ditches based on functional classification and design speed. In general, these ditch sections meet the traversability criteria in Figures 14.4E and 14.4F.

14.4.8 Rock Cuts

As indicated in Section 14.3.4, rough rock cuts located within the clear zone may be considered a roadside obstacle. The following will apply to their treatment:

1. Obstacle Identification. There is no precise method to determine whether or not a rock cut is sufficiently “ragged” to be considered a roadside obstacle. This will be a judgment decision based on a case-by-case evaluation.
2. Debris. A roadside obstacle may be identified based on known or potential occurrences of rock debris encroaching onto the clear zone or roadway. If rock debris is expected within the clear zone, a barrier for capturing the debris may be warranted.
3. Barrier Warrant. If the rock cut is within the clear zone, a barrier may be warranted.

14.4.9 Bridge Rails

Barrier protection is normally warranted on all approach ends to bridge rails or parapets, and it is normally warranted on the departure ends of two-way roadways. No roadside barrier is needed on the departure end of a one-way roadway, unless a barrier is warranted for other reasons (e.g., foreslopes steeper than 3H:1V).

The end of the bridge rail may be outside of the clear zone for opposing traffic at the departing end of a bridge on a two-way roadway. Although the hazard is outside the clear zone, barrier protection for the bridge rail will be provided unless there are compelling reasons not to provide protection (e.g., lack of available space on a low-speed urban street).

14.4.10 Retaining Walls

Section 17.2 discusses the design of retaining walls. With respect to roadside safety, barrier protection is not necessary for retaining walls within the clear zone which are considered “smooth” (i.e., the general absence of any unevenness in the wall which may adversely affect an impacting vehicle). Retaining walls built of sheet piling, H-piling with timber or precast concrete inserts are usually considered smooth. In addition, the following will apply to the roadside safety aspects of retaining walls:

1. Flare Rates. Use the same rates as those for concrete median barrier. See [Figure 14.6L](#).
2. End Treatment. Preferably, the retaining wall will be buried in a backslope thereby shielding its end. If this is not practical, use a crashworthy end treatment or impact attenuator.

14.4.11 Traffic Control Devices

Traffic control devices include highway signs, traffic signals and luminaires. The *SCDOT Standard Drawings* contain the Department's details for structural supports for traffic control devices. If not properly designed and located, these devices may become a hazard to errant vehicles. The Traffic Engineering Division is responsible for the initial placement of traffic control devices, based on proper conveyance of information to the motorist, and the road designer reviews the location to insure that it is compatible with the roadway design.

14.4.11.1 Highway Signs

For roadside safety applications, the following will apply to highway signs:

1. Ground-Mounted Sign Supports. All supports for ground-mounted signs within the clear zone should be made breakaway or yielding. Where practical, the designer should locate signs behind a roadside barrier which is warranted for other reasons. There should be adequate clearance to the back of the guardrail post to provide for the barrier dynamic deflection (see [Section 14.6](#)). In addition, sign supports should not be placed in drainage ditches where erosion and freezing might affect the proper operation of breakaway supports. It is also possible that a vehicle entering the ditch might be guided into the support.
2. Ground-Mounted Panel Signs. Large signs (i.e., over 50 square feet in area) should have slipbase breakaway supports, whether within or outside the clear zone. Where practical, the designer should locate signs behind a roadside barrier which is warranted for other reasons. There should be adequate clearance to the back of the guardrail post to provide for the barrier dynamic deflection (see [Section 14.6](#)). Breakaway sign supports should not be located in or near the flow line of ditches. The placement of breakaway sign supports on other than level terrain could compromise the proper function of the breakaway device because, among other reasons, a run-off-the-road vehicle may become airborne and strike the support too high (i.e., too close to the hinge). General Department practice is to avoid placing breakaway supports on side slopes steeper than 6H:1V.

3. Overhead Sign Supports. All overhead signs will use non-breakaway supports. Where supports are within the clear zone, the supports will be shielded with a roadside barrier or, where applicable, an impact attenuator.

14.4.11.2 Traffic Signal Equipment

In general, the designer has limited options available in determining acceptable locations for the placement of signal pedestals, signal poles, pedestrian detectors and controllers. Considering roadside safety, these elements should be placed as far from the roadway as practical. However, due to visibility requirements, limited mast-arm lengths, limited right of way, restrictive geometrics or pedestrian requirements, traffic signal equipment often must be placed relatively close to the traveled way. The designer should consider the following when determining the placement of traffic signal equipment:

1. Clear Zones. If practical, the placement of traffic signals on new construction and reconstruction projects should meet the clear zone criteria (without curbs) or obstruction-free clearance criteria (with curbs) presented in [Section 14.3](#).
2. Controller. In determining the location of the controller cabinet, the designer should consider the following:
 - a. The controller cabinet should be placed in a position so that it is unlikely to be struck by errant vehicles. It should be outside the clear zone or obstruction-free zone, if practical.
 - b. The controller cabinet should be located where it can be easily accessed by maintenance personnel.
 - c. The controller cabinet should be located so that a technician working in the cabinet can see the signal indications in at least one direction.
 - d. The controller cabinet should be located where the potential for water damage is minimized.
 - e. The controller cabinet should not obstruct intersection sight distance.
 - f. The power service connection should be reasonably close to the controller cabinet.

14.4.12 Luminaires

Because of the potential hazard posed to vehicles by roadside fixed objects, the general approach to lighting standards will be to use breakaway supports wherever practical.

All new lighting standards located within the clear zone of a roadway where no pedestrian facilities exist will be placed on breakaway supports, unless they are located behind or on a barrier or protected by impact attenuators which are necessary for other roadside safety reasons. Poles outside the clear zone on these roadways should also be breakaway where there is a possibility of being struck by errant vehicles.

On roadways where pedestrian facilities exist, the designer should review the volume of pedestrian traffic to determine if a breakaway support will present a greater potential hazard to the pedestrian traffic than a non-breakaway support will to the vehicular traffic. Examples of locations where the hazard potential to pedestrian traffic may be greater include:

- sports stadiums and associated parking areas,
- tourist attractions,
- school zones, or
- central business districts and local residential neighborhoods where the speed limit is 30 miles per hour or less.

In these locations, non-breakaway supports may be more appropriate. Other locations which may justify the use of non-breakaway bases, regardless of the pedestrian traffic volume, are rest areas, weigh stations, and combined light and traffic signal poles.

14.5 ROADSIDE BARRIERS

14.5.1 Types

SCDOT *Standard Drawings* present the details on the roadside barrier types used by the Department. The following Sections briefly describe each system and its typical usage.

14.5.1.1 Steel Beam Guardrail

The steel beam guardrail with strong posts is a semi-rigid system. The longitudinal member is the traditional 12¼-inch W-beam. In general, this guardrail system is the preferred selection on non-freeways and on rural freeways. A major objective of the strong post system is to prevent a vehicle from “snagging” on the posts. This is achieved by using blockouts to offset the posts from the longitudinal beam and by establishing 6 feet – 3 inches as the maximum allowable post spacing. All blockouts must be wood or composite; however, do not mix the blockout types on a new project.

14.5.1.2 Thrie Beam

The thrie beam guardrail is also a semi-rigid system on strong posts. The deeper longitudinal member (20 inches) of the thrie beam decreases the probability of an impacting vehicle overriding or underriding the guardrail. In addition, the thrie beam performs somewhat better than the 12-inch beam when impacted by a bus or large truck. Therefore, typical sites for installing the thrie beam include its use as a transition into rigid obstacles (e.g., bridge parapets) or as a barrier between the traveled way and a fixed object where the deflection distance is limited (e.g., bridge piers). For further details, see *SCDOT Standard Drawings*.

14.5.1.3 Half-Section Concrete Barrier

A half-section concrete barrier may be considered on the roadside to shield rigid objects where no deflection distance is available, where many hits are anticipated, and/or where there is a high volume of heavy trucks (see [Section 14.5.2](#)). In particular, a concrete barrier may be advantageous as a roadside barrier on urban freeways wherever a barrier is warranted. If a rigid object is not continuous (e.g., bridge piers), this is also an especially good candidate site to use a half-section concrete barrier. The shape of the wall face should be determined based on the project application. To provide the necessary lateral support, provide backfill behind the half-section, or the barrier should have a special footing design (e.g., tied to a concrete surface with reinforcing steel). If this is not practical, use the full-section concrete median barrier to provide the needed stability and support.

14.5.1.4 Other Systems

Many other roadside barrier systems are available which may have application at specific sites (e.g., cable rail). The designer should reference the *AASHTO Roadside Design Guide* for information on these systems. The Road Design Section must approve the use of any system not included in the *SCDOT Standard Drawings*.

14.5.2 Barrier Selection

14.5.2.1 Performance Criteria

The barrier performance-level requirements must be considered when selecting an appropriate roadside barrier. At the national level, FHWA and AASHTO are continuously examining the performance criteria to evaluate the acceptability of roadside safety appurtenances and testing these appurtenances to determine if they meet these performance criteria. Currently, NCHRP 350 *Recommended Procedures for the Safety Performance Evaluation of Highway Features* has been adopted for application. SCDOT is responsible for remaining abreast of the state of the technology and revising its roadside safety hardware practices to comply with the national performance criteria.

NCHRP 350 presents six roadside barrier test levels (TL) for application to various highway conditions based on facility type, design speed and prevalence of heavy vehicles. SCDOT has determined that the minimum acceptable test level for roadside barriers is TL-3 on all State-maintained highways.

Traditionally, most roadside barriers have been developed and tested for passenger cars and offer marginal protection when struck by heavier vehicles at high speeds and at other than flat angles of impact. Therefore, if passenger vehicles are the primary concern, the steel beam system will normally be selected. However, locations with high traffic volumes, high speeds, high-crash experience and/or a significant volume of heavy trucks and buses may warrant a higher performance level barrier (e.g., the three beam or half-section concrete barrier). This is especially important if barrier penetration by a vehicle is likely to have serious consequences.

14.5.2.2 Dynamic Deflection

The dynamic deflection must also be considered in barrier selection. [Figure 14.6I](#) provides the deflection distances for the various systems. If there is no deflection distance available, the half-section concrete barrier must be used.

14.5.2.3 Maintenance

Another consideration in selecting the barrier type depends on maintenance of the system. Although the steel beam guardrail can often sustain second hits, it will need to be repaired with some frequency. In areas of restricted geometry, high speeds, high traffic volumes and/or where railing repair creates hazardous conditions for both the repair crew and for motorists using the roadway, a rigid barrier should be considered. The half-section concrete barrier also allows better control of roadside vegetation, and it provides a more convenient means to transition into bridge piers. For these reasons, the half-section concrete barrier is often used as a roadside barrier on urban freeways where a barrier is required.

[Figure 14.5A](#) summarizes the advantages and disadvantages of the roadside barriers used by SCDOT and provides their typical usage.

SYSTEM	ADVANTAGES	DISADVANTAGES	TYPICAL USAGE
Steel Beam Guardrail	<ul style="list-style-type: none"> • Lower initial cost. • High level of familiarity by maintenance personnel. • Can safely accommodate wide range of impact conditions for passenger vehicles. • Relatively easy installation. • Remains functional after moderate collisions. 	<ul style="list-style-type: none"> • Cannot accommodate impacts by large vehicles at other than flat angles of impact. • At high-impact locations, will require frequent maintenance. • Susceptible to vehicular underride and override. • Susceptible to vehicular snagging. • Requires height adjustments after pavement overlays. 	<ul style="list-style-type: none"> • Non-freeways. • Rural freeways.
Thrie Beam	<ul style="list-style-type: none"> • Can accommodate large vehicle impacts better than steel beam guardrail. • Better protection against vehicular underride and override than steel beam guardrail. • Will remain functional after collisions better than steel beam guardrail. • More flexibility than steel beam guardrail to remain serviceable after pavement overlays without height adjustment. • Less deflection distance required than steel beam guardrail. 	<ul style="list-style-type: none"> • Higher initial cost. • Less familiarity by maintenance personnel. • For given impact conditions, higher occupant decelerations than steel beam guardrail. 	<ul style="list-style-type: none"> • At sites intermediate in character between those for steel beam guardrail and half-section concrete barrier.
Half-Section Concrete Barrier	<ul style="list-style-type: none"> • Can accommodate most vehicular impacts without penetration. • Little or no deflection distance required behind barrier. • Little or no damage sustained for most vehicular impacts; therefore, least need for maintenance. • No vehicular underride/override potential or snagging potential. 	<ul style="list-style-type: none"> • Highest initial cost. • Can induce vehicular rollover. • For given impact conditions, highest occupant decelerations; therefore, least forgiving of barrier systems. • Reduced performance where offset between traveled way and barrier exceeds 12 feet. 	<ul style="list-style-type: none"> • Urban freeways. • Where both high traffic volumes and high travel speed are present. • Where high volumes of large vehicles are present. • Where poor geometrics exist.

ROADSIDE BARRIER SELECTION

Figure 14.5A

14.6 ROADSIDE BARRIER LAYOUT

The *SCDOT Standard Drawings* contain significant information on the layout of roadside barriers. This includes:

- the placement of barriers with respect to fill slope breaks,
- the layout of end treatments,
- the placement of barriers at roadside hazards and bridge approaches,
- slope rates adjacent to and approaching barriers,
- guardrail-to-bridge-rail transitions, and
- the extent of paving under guardrail.

The designer must insure that the layout of all roadside barriers is consistent with the *SCDOT Standard Drawings*. Section 14.6 presents additional information that applies to barrier layout.

14.6.1 Length of Need

14.6.1.1 Basic Calculation

A roadside barrier must be extended a sufficient distance upstream and/or downstream from the hazard to safely protect a run-off-the-road vehicle. Otherwise, the vehicle could travel behind the barrier and impact the hazard. The designer should recognize that vehicles depart the road at relatively flat angles. Based on a number of field studies, the average angle of departure is estimated to be 10 degrees. The 80th percentile is estimated to be 15 degrees. These flat angles of departure result in the need to extend the barrier a significant distance in advance of the hazard.

Many factors combine to determine the appropriate length of need for a given roadside condition. These include:

- the distance to the outside limit of the hazard (L_A) or the clear zone (L_C), whichever is less;
- the distance between the edge of traveled way and the barrier (L_2);
- the runout length (L_R), which is based on the design speed (V) and the traffic volume on the facility;
- the length of hazard (L_H), as measured parallel to the roadway;
- whether or not the barrier is on a flare; and
- on two-way facilities, whether or not the barrier needs to be extended to provide protection for the traffic in the opposing direction.

Figures 14.6A and 14.6B illustrate the variables that will determine the barrier length of need. Figure 14.6A applies to a roadway with traffic moving in one direction or to a two-way roadway where the hazard is not within the clear zone of the opposing direction of travel. Figure 14.6B applies to a two-way facility where the roadside hazard is within the clear zone of the opposing direction of traffic.

To determine the length of need, use the nomograph in Figure 14.6C and the following procedure:

1. Construct a horizontal line at L_2 on the y-axis (the lateral distance of the barrier from the edge of traveled way). This assumes that the barrier is not flared (i.e., it is parallel to the roadway).
2. Locate L_A or L_C , whichever is less, on the y-axis.
3. Determine the L_R from Figure 14.6D and locate L_R on the x-axis. If barrier protection is needed for only the approaching traffic, only use the scale marked "Edge of Traveled Way Scale." If needed for both directions of travel, locate L_R on both scales marked "Edge of Traveled Way Scale" and "Centerline Scale." See Step 7 to determine the downstream end of the barrier where the hazard does not require shielding for the opposing traffic.
4. Connect the points in Steps 2 and 3 with a straight line or two straight lines.
5. Locate the intersection(s) of the lines in Steps 1 and 4. From this point(s), draw a line vertically to the L_R Scale(s).
6. Read L_1 from the L_R Scale(s). As illustrated on Figures 14.6A and 14.6B, X is measured from the lateral edge of hazard to the beginning of the end terminal (i.e., it does not include the terminal).
7. Extend the barrier 12.5 feet past the far end of the hazard.
8. The length of need determined in the above steps must be adjusted to provide full 12 feet – 6 inch panels of guardrail. The length of guardrail required is always rounded up.

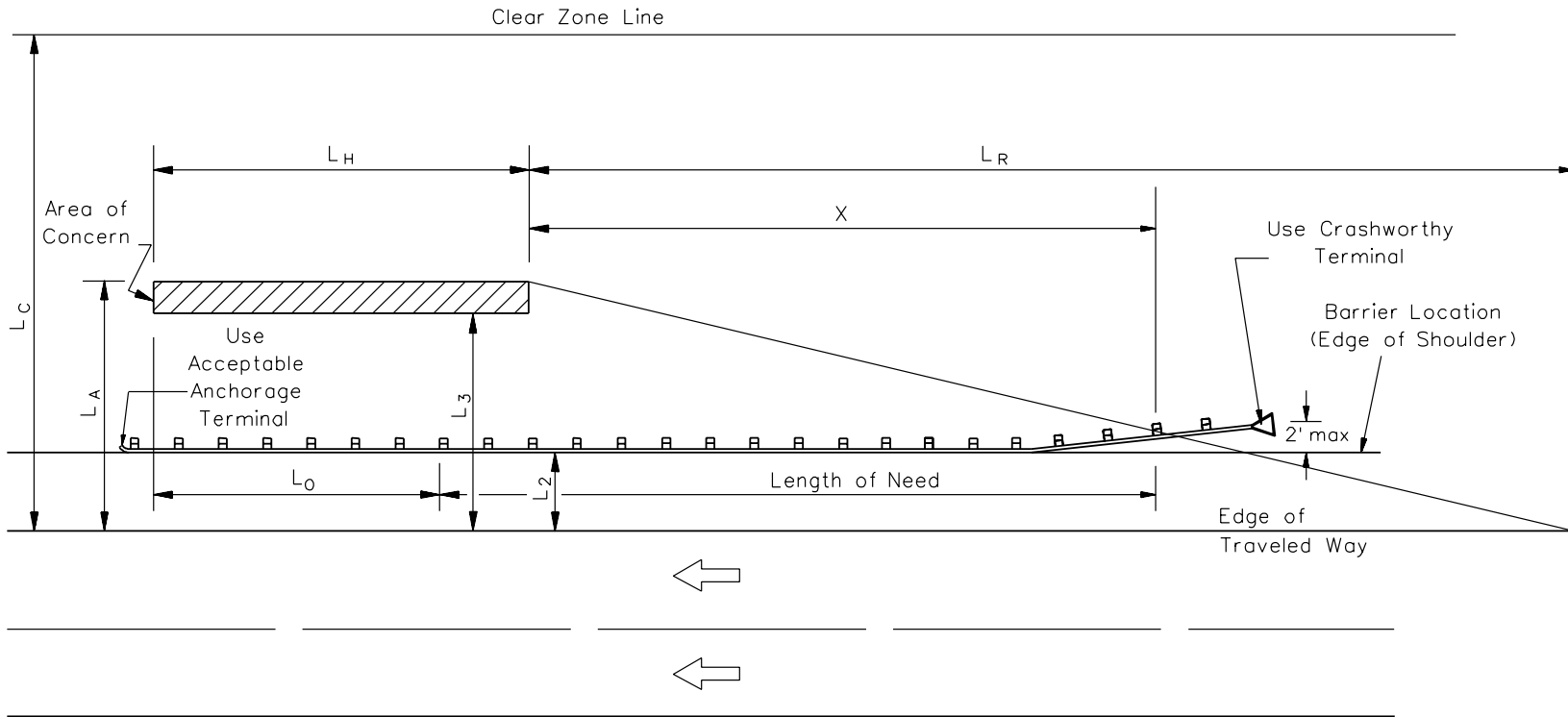

Note: This figure also applies to roadside hazards on two-way roadways where shielding is not required for the opposing flow of traffic. See nomograph (Figure 14.6C) to solve for length of need.

- L_2 = Distance to barrier
- L_C = Clear zone
- L_A = Distance to back of hazard
- L_3 = Distance to front of hazard
- L_R = Runout length (see Figure 14.6D)
- X = Length needed for approach end
- L_H = Length of hazard
- L_0 = Length to be omitted from length of need

**BARRIER LENGTH OF NEED LAYOUT
(One-Way Roadways)**

Figure 14.6A

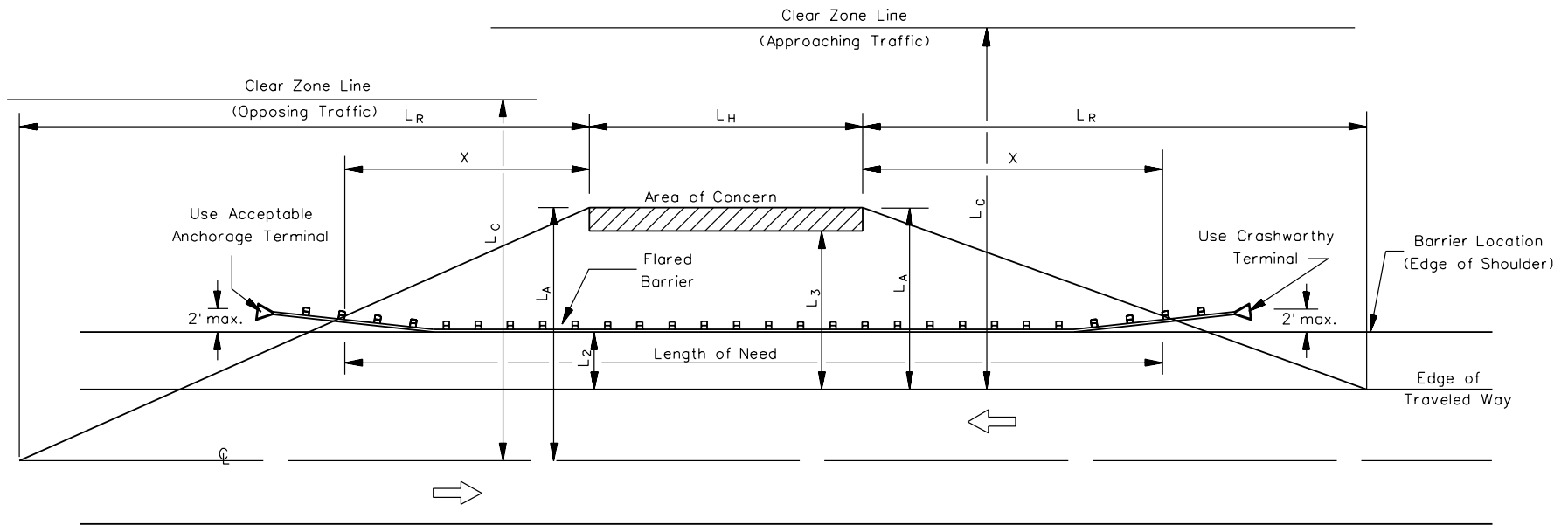

Note: This figure also applies to roadside hazards on two-way roadways where shielding is required for the opposing flow of traffic. See nomograph (Figure 14.6C) to solve for length of need.

- L_2 = Distance to barrier
- L_C = Clear zone
- L_A = Distance to back of hazard
- L_3 = Distance to front of hazard
- L_R = Runout length (see Figure 14.6D)
- X = Length needed for approach end
- L_H = Length of hazard

BARRIER LENGTH OF NEED LAYOUT (Two-Way Roadways)

Figure 14.6B

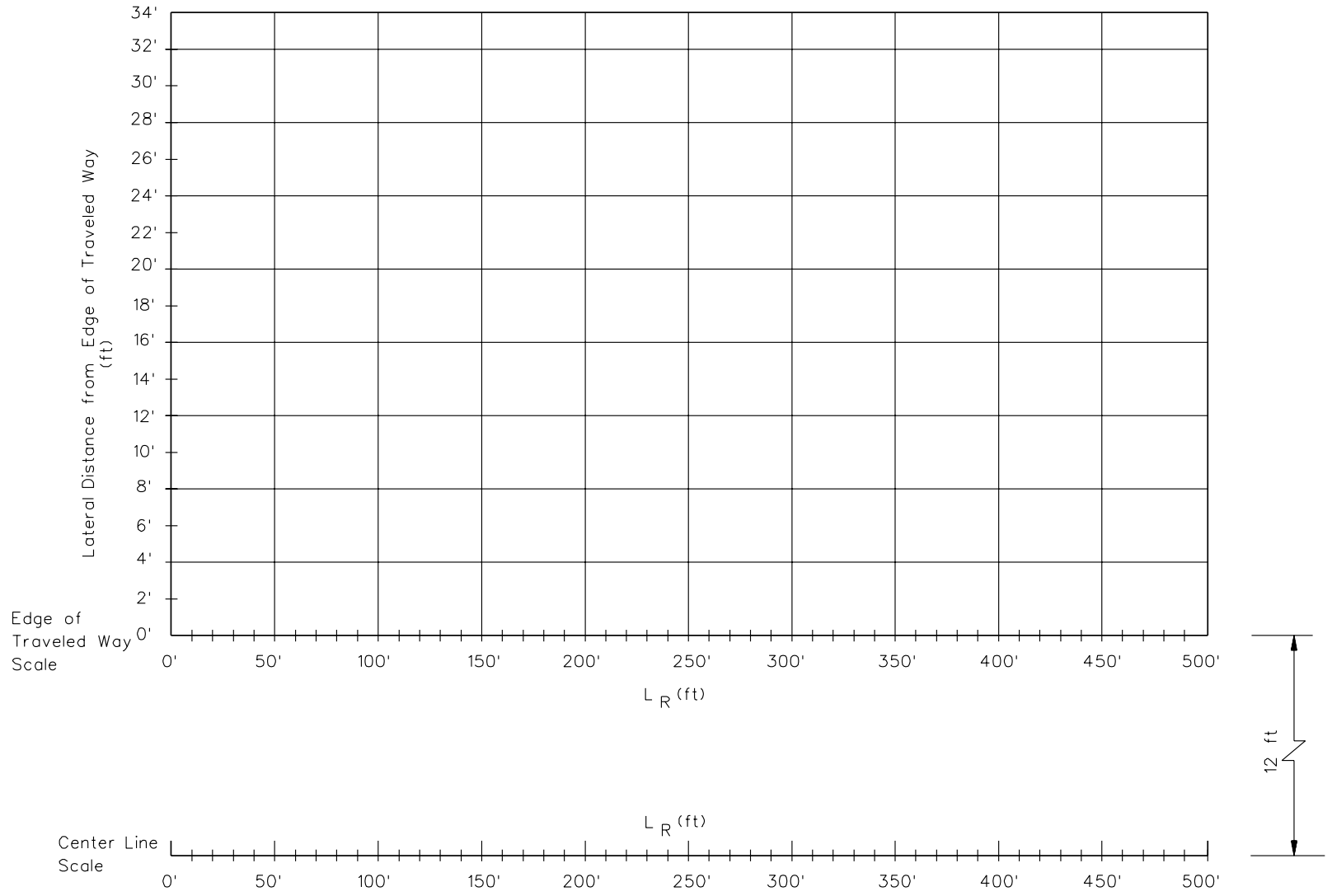

Note: This nomograph solves for X on [Figures 14.6A](#) and [14.6B](#).

**BARRIER LENGTH OF NEED CALCULATION
(For Approaching End)**

Figure 14.6C

Design Speed (mph)	Traffic Volume (ADT)*			
	Over 6000	2000-6000	800-2000	Under 800
	Runout Length L_R (ft)	Runout Length L_R (ft)	Runout Length L_R (ft)	Runout Length L_R (ft)
70	475	445	395	360
65	450	425	370	345
60	425	400	345	330
55	360	345	315	280
50	330	300	260	245
45	260	245	215	200
40	230	200	180	165
35	200	185	165	150
30	165	165	150	130

*Based on a 10-year projection from the anticipated date of construction.

RUNOUT LENGTHS FOR BARRIER DESIGN

Figure 14.6D

Example 14.6(1) (One-Way Traffic)

Given: Design ADT = 7000
 $V = 70$ miles per hour
 Slope = 6H:1V front slope
 Tangent roadway
 Shoulder width = 10 feet = L_2
 $L_A = 25$ feet
 One-way roadway
 $L_3 = 15$ feet
 Unflared barrier (steel beam guardrail) located at edge of shoulder

Problem: Determine the barrier length of need.

Solution: Using the procedure in [Section 14.6.1.1](#), the following steps apply (see solution in [Figure 14.6E](#)):

1. $L_2 = 10$ feet. [Figure 14.6E](#) illustrates the horizontal line.
2. From [Figure 14.3A](#), $L_C = 30$ feet. Therefore, because $L_A < L_C$, locate $L_A = 25$ feet on the y-axis.

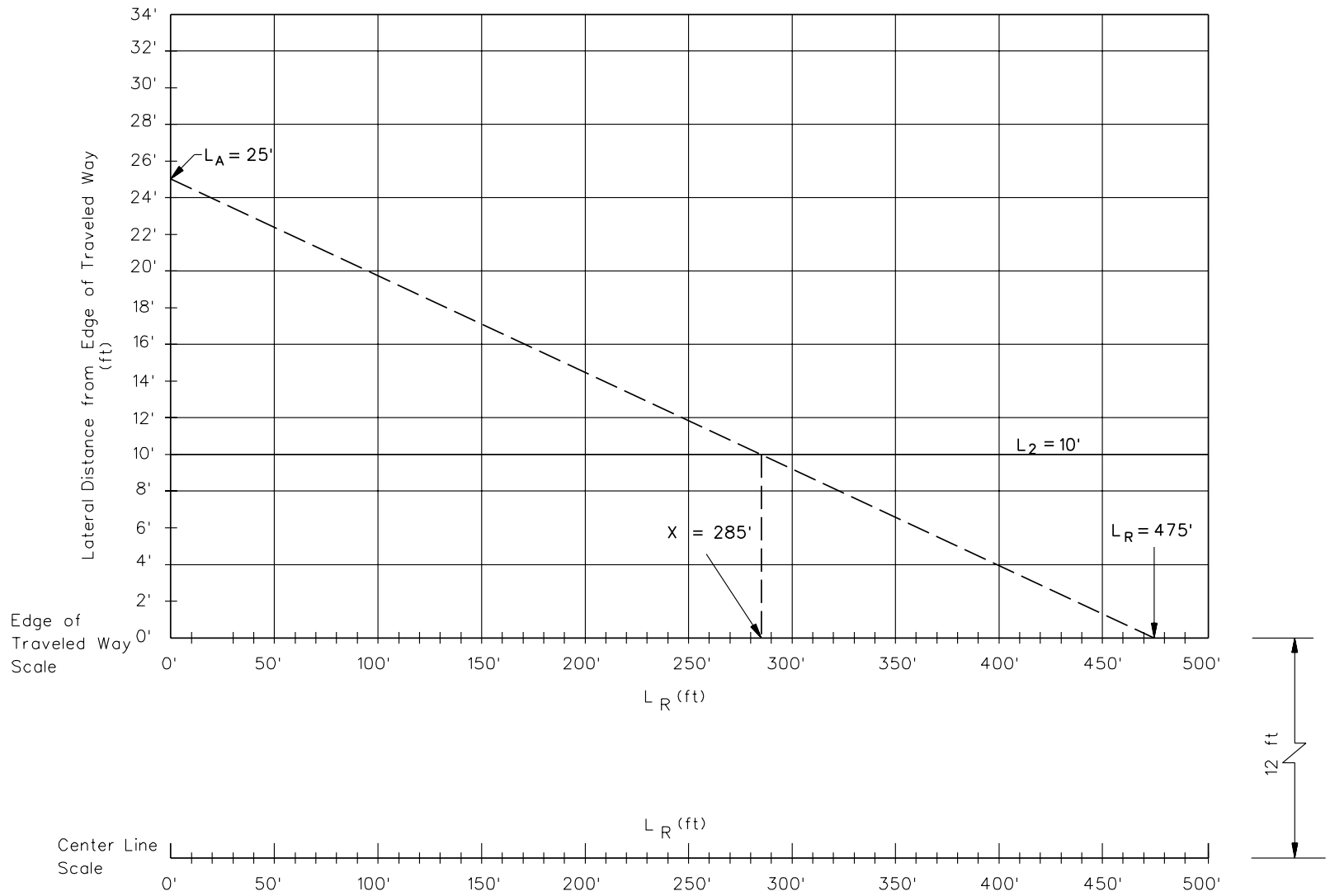

BARRIER LENGTH OF NEED CALCULATION
(Example 14.6(1))

Figure 14.6E

3. From [Figure 14.6D](#), $L_R = 475$ feet. Locate point on “Edge of Traveled Way Scale.”
4. Connect the points in Steps 2 and 3.
5. Draw the vertical line down to the L_R scale.
6. Read $X = 285$ feet.
7. Extend the barrier to 12.5 feet past the far side of the hazard.
8. Round X as discussed to insure only full-length panels of guardrail are used.

Example 14.6(2) (Two-Way Traffic)

Given: Design ADT = 5000
 $V = 60$ miles per hour
 Slope = 4H:1V front slope
 Tangent roadway
 Shoulder width = 8 feet = L_2
 $L_A = 15$ feet
 Two-way roadway
 $L_3 = 10$ feet (use steel beam guardrail) located at edge of shoulder

Problem: Determine the barrier length of need.

Solution: Using the procedure in [Section 14.6.1.1](#), the following steps apply (see solution in [Figure 14.6F](#)):

1. $L_2 = 8$ feet. [Figure 14.6F](#) illustrates the horizontal line.
2. From [Figure 14.3A](#), $L_C = 30$ feet. Therefore, because $L_A < L_C$, locate $L_A = 15$ feet on the y-axis.
3. From [Figure 14.6D](#), $L_R = 400$ feet. Locate point on “Edge of Traveled Way Scale” and “Center Line Scale.”
4. Connect the points in Steps 2 and 3.
5. Draw the vertical line down to the L_R scales.

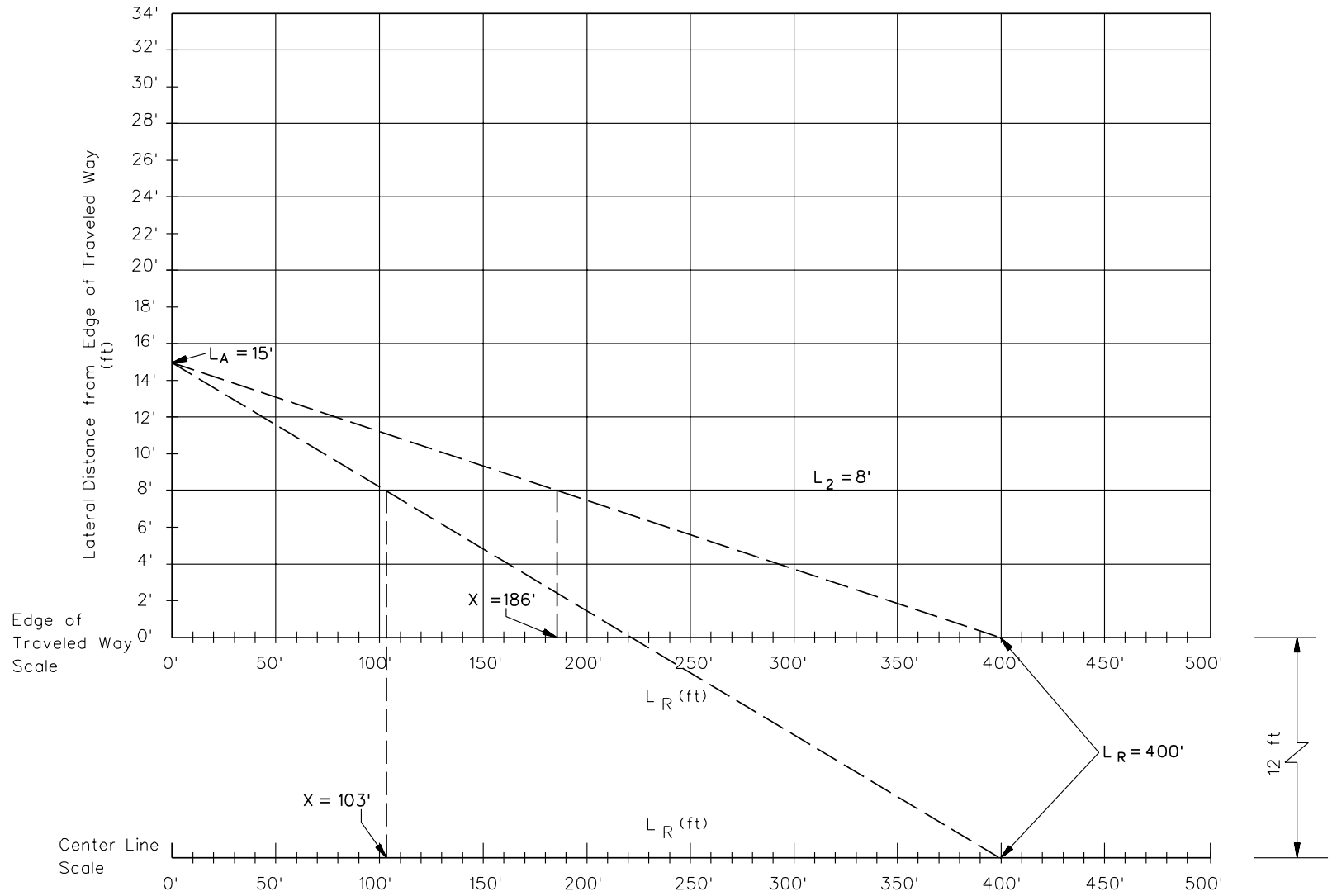

BARRIER LENGTH OF NEED CALCULATION

(Example 14.6(2))

Figure 14.6F

6. Read $X = 186$ feet upstream from the hazard and $X = 103$ feet downstream from the hazard.
7. Length should be calculated for each approach.
8. Round X upstream and downstream as discussed to insure only full-length panels of guardrail are used.

Example 14.6(3) (Flared Barrier)

Note: A barrier flare may be used to reduce the length of need. For more information, see [Section 14.6.5](#). This Example is identical to [Example 14.6\(1\)](#) except for the use of a flared barrier.

Given: Design ADT = 7000
 $V = 70$ miles per hour
 Slope = 6H:1V front slope
 Tangent roadway
 Shoulder width = 10 feet = L_2
 $L_A = 25$ feet
 One-way roadway
 $L_3 = 15$ feet
 Barrier (W-beam guardrail, Type A) with 20:1 flare

Problem: Determine the barrier length of need.

Solution: Using the procedure in [Section 14.6.1.1](#) (adjusted for flare), the following steps apply (see solution in [Figure 14.6G](#)):

1. [Figure 14.6G](#) illustrates the location of barrier with 20:1 flare.
2. From [Figure 14.3A](#), $L_C = 30$ feet. Therefore, because $L_A < L_C$, locate $L_A = 25$ feet on the y-axis.
3. From [Figure 14.6D](#), $L_R = 475$ feet. Locate point on "Edge of Traveled Way Scale."
4. Connect the points in Steps 2 and 3.
5. Draw the vertical line down to the L_R scale.

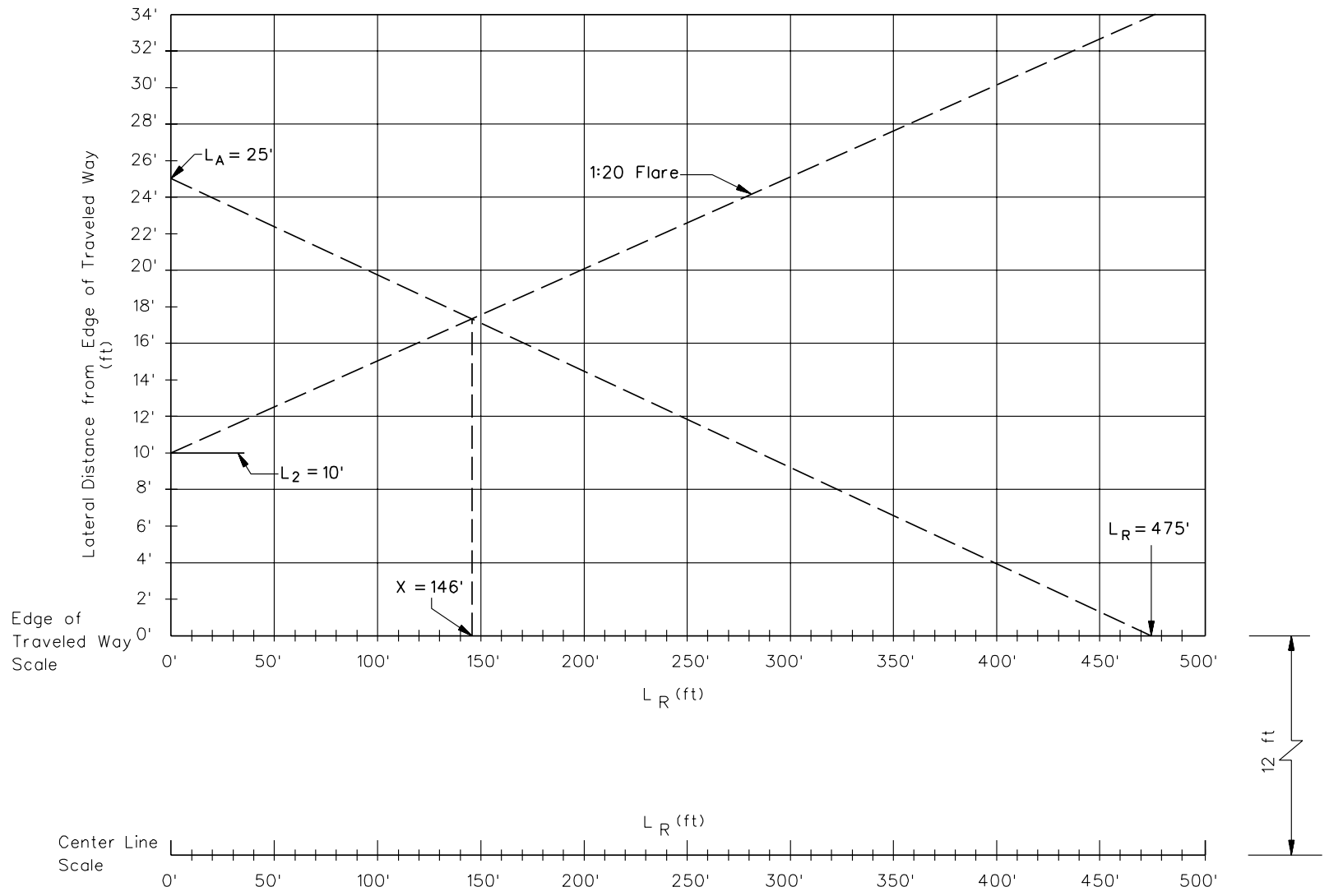

BARRIER LENGTH OF NEED CALCULATION

(Example 14.6(3))

Figure 14.6G

6. Read $X = 146$ feet. *Note that, for the unflared barrier in [Example 14.6\(1\)](#), $X = 285$ feet.*
7. Extend the barrier to 12.5 feet past the far side of the hazard.
8. Round X as discussed to insure only full-length panels of guardrail are used.

* * * * *

14.6.1.2 End Terminals

The designer should note that only a portion of the terminal sections are included in the overall barrier length of need. See the *SCDOT Standard Drawings* to determine the portion of the terminal section which may be included in the total length of need for the barrier.

14.6.1.3 Length of Need (Outside of Horizontal Curves)

The length of need calculation in [Section 14.6.1.1](#) is applicable to tangent highway alignment and where the roadside obstacle is on the inside of a horizontal curve. A vehicle leaving the roadway on the outside of a horizontal curve will generally follow a tangential runout path. Therefore, rather than using the theoretical L_R distance to determine the length of need, use a tangent line from the edge of the traveled way to the outside edge of the obstacle. The length of need is determined by intersecting the barrier installation line with the tangent line. See [Figure 14.6H](#). This intersection can most readily be obtained graphically. If the tangent line is less than L_R , use this intersection. However, if the tangent line is greater than L_R , use the L_R distance from the back of the obstacle to intersect the installation line to determine the adjacent length. A flared end treatment is generally not used along a horizontal curve.

14.6.1.4 Length of Need (Bridge Approaches)

The length of need for roadside barriers approaching bridges is determined by the basic calculation presented in [Section 14.6.1.1](#). The critical design parameter selection is for L_A . This will be set equal to the clear zone (L_C) determined in [Section 14.3](#).

14.6.2 Lateral Placement

Roadside barriers should be placed as far as practical from the edge of traveled way. Such placement provides an errant motorist the best chance of regaining control of the vehicle without impacting the barrier. It also provides better sight distance, particularly at nearby intersections. The following factors should be considered when determining barrier lateral placement:

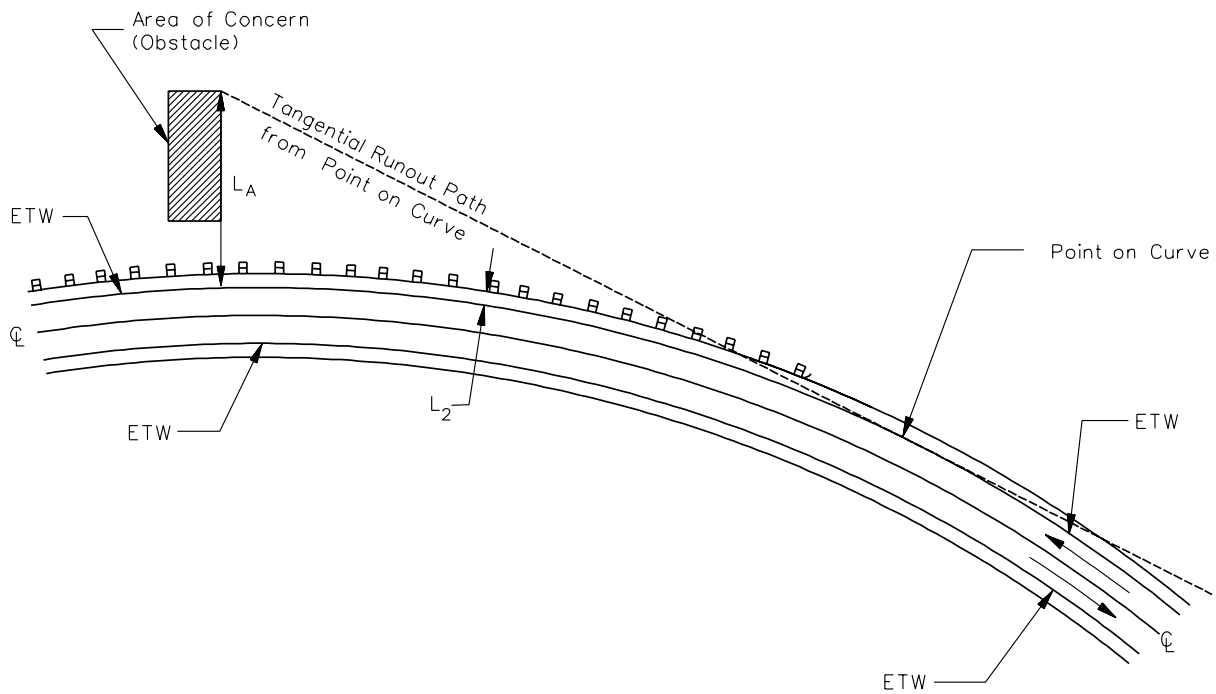

**BARRIER LENGTH OF NEED
(Outside of Horizontal Curve)**

Figure 14.6H

Barrier Type	Deflection Distance
Steel Beam Guardrail @ 6'-3" post spacing	3 ft
Steel Beam Guardrail @ 3'-1½" post spacing	2 ft
Thrie Beam @ 6'-3" post spacing	2 ft
Thrie Beam @ 3'-1½" post spacing	1 ft
Half-section Concrete Barrier	0 ft

DYNAMIC DEFLECTION OF BARRIERS

Figure 14.6I

1. Shoulder. Typically, the roadside barrier is located at the edge of the shoulder so that the face of the barrier is flush with the outside edge of the shoulder.
2. Deflection. The dynamic deflection distance of the barrier, as measured from the back of the post, should not be violated. [Figure 14.6I](#) provides the deflection distances for the types of roadside barriers typically used by SCDOT.
3. Shy Distance. Drivers tend to “shy” from continuous longitudinal obstacles along the roadside, such as guardrail. Therefore, the lateral barrier offset should desirably be based on the criteria in [Figure 14.6J](#).

Design Speed (miles per hour)	Shy Line Offset (feet)
70	10.0
65	9.0
60	8.0
55	7.2
50	6.5
45	5.7
40	5.0
35	4.2
30	3.5

SHY LINE OFFSET

Figure 14.6J

4. Slope Break. Where a barrier is placed in front of a fill slope, it is necessary to provide a minimum of 42 inches in width behind the face of guardrail to provide the necessary lateral support, to reduce erosion and to lessen maintenance needs.

14.6.3 Placement Behind Curbs

If practical, roadside barriers should not be placed in conjunction with either sloping or vertical curbs, especially where $V \geq 50$ miles per hour. Where this is necessary, the following will apply (see [Figure 14.6K](#)):

1. Roadside Barrier/Curb Orientation. The barrier face should be 6 inches from the face of curb. The height of the guardrail must be measured from the top of curb. Consider stiffening the guardrail to reduce potential deflection. Measures that usually prove satisfactory are bolting a W-beam to the back of the posts, reducing post spacing, double nesting the rail or adding a rubrail.
2. Lateral Placement. The table in [Figure 14.6K](#) presents criteria to determine proper barrier placement behind curbs.

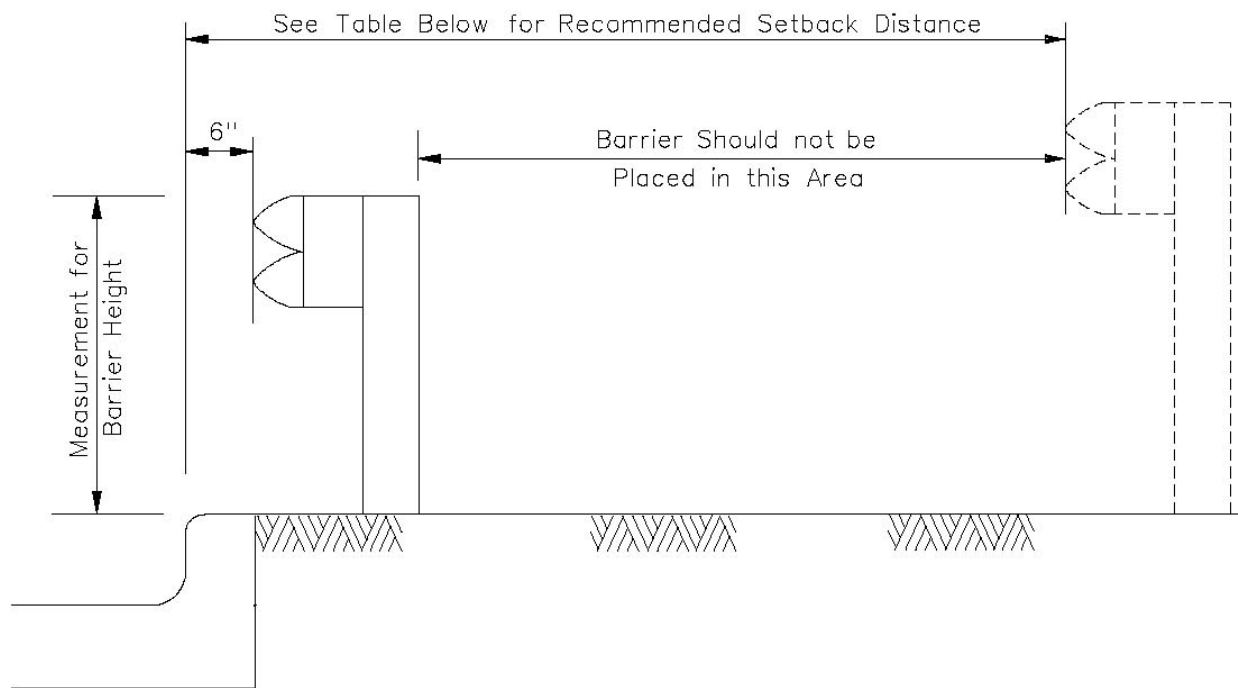

Design Speed (mph)	Curb-to-Barrier Distance* (ft)	
	Vertical	Sloping
$V \leq 30$	0.5	0.5
$30 < V \leq 45$	5.6	8.0
$V > 45$	18.2	16.3

*Values in table represent distance beyond which it is acceptable to place a barrier.

Notes:

1. The curb-to-barrier distances in the table are based on information presented in the AASHTO 1977 Guide for Selecting, Locating, and Designing Traffic Barriers, Appendix F, pp. 284 – 287. Specifically, the criteria for the vertical curb are based on the Type A Curb. For the $30 < V \leq 45$ mile-per-hour range, the 5-foot distance assumes an encroachment speed of 40 miles per hour and a 10-degree impact angle. For the $V > 45$ mile-per-hour range, the 18-foot distance assumes 60 miles per hour and 25 degrees.

The criteria for the sloping curb are based on the Type E Curb. For the $30 < V \leq 45$ mile-per-hour range, the 8-foot distance assumes an encroachment speed of 45 miles per hour and a 12.5 degree impact angle. For the $V > 45$ mile-per-hour range, the 16-foot distance assumes 60 miles per hour and 20 degrees.

2. Barrier should be placed 6 inches behind curb; rail stiffening should be considered. See Section 14.6.3.

PLACEMENT OF BARRIER RELATIVE TO CURBS

Figure 14.6K

Curb to Barrier Distances – Revised: 10-2003

Dimension moved to top of curb – Revised: 10-2004

14.6.4 Placement on Slopes

Slopes in front of a barrier should be 10H:1V or flatter. This also applies to the areas in front of the flared section of guardrail and to the area approaching the terminal ends.

14.6.5 Barrier Flare

Using a flared barrier in advance of a roadside hazard may be advantageous. A barrier may be flared to:

- locate the barrier terminal farther from the traveled way,
- minimize a driver's reaction to an obstacle near the roadway by gradually introducing a parallel barrier installation,
- transition a roadside barrier closer to the roadway because of an obstacle, or
- to reduce the total length of barrier need.

Also consider the following:

1. Flared guardrail results in increased impact angles with the potential for greater severity of impact.
2. Flared guardrail increases the likelihood that the vehicle will be redirected into the opposing lane of traffic or across the roadway.
3. The grading required to provide 10H:1V or flatter slopes in front of the flared section of guardrail may interfere with roadside drainage and/or may require additional right of way.

Figure 14.6L presents suggested flare rates for roadside barriers which are intended to balance the advantages and disadvantages of flares.

14.6.6 Terminal Treatments

Barrier terminal sections present a potential roadside hazard for run-off-the-road vehicles; however, they are also critical to the proper structural performance of the barrier system. Therefore, the designer must carefully consider the selection and placement of the terminal end.

Design Speed (mph)	Flare Rate for Barrier Inside Shy Line*	Flare Rate for Barrier Beyond Shy Line*	
		Rigid (Concrete Barrier)	Semi-Rigid (Steel Beam, Thrie Beam)
30	13:1	8:1	7:1
35	15:1	9:1	8:1
40	16:1	10:1	8:1
45	18:1	12:1	10:1
50	21:1	14:1	11:1
55	24:1	16:1	12:1
60	26:1	18:1	14:1
65	28:1	19:1	15:1
70	30:1	20:1	15:1

*See [Figure 14.6J](#) for shy line distances.

SUGGESTED FLARE RATES FOR BARRIER DESIGN

Figure 14.6L

The *SCDOT Standard Drawings* present the design details for end treatments used by the Department. The following summarizes their usage:

1. Buried Guardrail Terminal. A buried terminal should be used where the barrier end is in a cut section, where the backslope is 2H:1V or steeper and where the depth of the cut exceeds the height of the rail by a minimum of 1 foot.
2. Type T End Treatment. Use the Type T terminal for all end treatments that warrant a crashworthy treatment, most commonly on the approach end of a barrier that is within the clear zone. The Type T end treatment does not require an offset; however, it can be offset up to a maximum of 2 feet if installed on a 25:1 taper over the full length of the terminal.
3. Type B End Treatment. Use the Type B terminal for end treatments that do not require a crashworthy treatment (e.g., on the departing end of a barrier on a one-way roadway).

The standard end treatments allow a portion of the terminal to be included in the length of need.

14.6.7 Transitions

Barrier transitions are necessary to join two systems with different structural and/or dynamic characteristics. For example, this occurs when steel beam guardrail

approaches a bridge parapet, a concrete barrier installation or a thrie beam. The *SCDOT Standard Drawings* provide details for these barrier transitions.

14.6.8 Minimum Length/Gaps

Short runs of barrier have limited value and should be avoided unless designed especially to shield a point hazard. In general, a barrier should have at least 100 feet of standard guardrail section exclusive of terminal sections and/or transition sections. Likewise, short gaps between runs of barrier are undesirable. In general, gaps of less than 200 feet between barrier termini should be connected into a single run. Exceptions may be necessary for access.

14.6.9 Adjustable Height Guardrail

Generally, adjustable guardrail should be placed in runs of 1,000 linear feet or more to be cost effective. For locations requiring less than 1,000 linear feet of guardrail, adjustable guardrail is not required but may be used. When adjustable guardrail is adjusted, end treatments and bridge connections must be replaced. See the *SCDOT Standard Drawings*.

14.7 MEDIAN BARRIERS

14.7.1 Types

The *SCDOT Standard Drawings* present the details on the median barrier types used by the Department. The following briefly describes each type:

1. Concrete Median Barrier. The concrete median barrier (CMB) is a rigid system that will rarely deflect upon impact. A half-section CMB may be necessary where the median barrier must divide to go around a fixed object in the median (e.g., bridge piers). In this situation, the obstacle is typically encased within concrete to create a level surface from CMB face to CMB face.
2. Cable Median Barrier. The cable median barrier is a weak-post, flexible system with a large dynamic deflection. Most of the resistance to impact is supplied by the tensile forces developed in the cable strands. Upon impact, the cables break away from the posts, and the vehicle is able to knock down the posts as it is redirected by the cables. The detached posts do not contribute to controlling the lateral deflection. However, the posts which remain in place do provide a substantial part of the lateral resistance to the impacting vehicle and are therefore critical to proper performance. The cable median barrier is the most forgiving of the available systems because of its large dynamic deflection.

14.7.2 Median Barrier Warrants/Selection

SCDOT has adopted the following guidelines for the selection of median barrier systems on freeways and other fully access-controlled facilities:

1. Median Width > 72 Feet. In the absence of an adverse history of crossover crashes, a median barrier typically will not be installed.
2. Median Width \leq 72 Feet and \geq 36 Feet. Use the cable median barrier.
3. Median Width < 36 Feet. Use the concrete median barrier. As indicated in the *SCDOT Standard Drawings*, the height of the standard CMB is 32 inches. However, this height may not successfully redirect heavy vehicles if the impact speed and angle are high. Therefore, on some freeways, it may be warranted to install the "tall" CMB, which includes a 24-inch barrier extension for a total height of 56 inches.

14.7.3 Median Barrier Layout

The *SCDOT Standard Drawings* contain significant information on the design and layout of median barriers. This includes:

- the various CMB shapes that the designer may select from (e.g., Jersey shape, single slope);
- placement on superelevated sections;
- barrier transitions around roadside obstacles in the median;
- barrier transitions specifically at bridge piers;
- the attachment of lighting standards to the top of a CMB; and
- placement where there is an elevation differential between the two roadways.

The designer must insure that the layout of all median barriers is consistent with the *SCDOT Standard Drawings*. In addition, much of the information presented in [Section 14.6](#) on roadside barrier layout also applies to median barriers (e.g., placement behind curbs). [Section 14.7.3](#) presents additional criteria specifically for the design of median barriers.

14.7.3.1 Median Slopes

A concrete median barrier (CMB) must not be placed on a slope steeper than 10H:1V. The cable median barrier may be placed on median slopes as steep as 6H:1V. Also, the cable median barrier should be offset 2 feet on either side of the median centerline to avoid possible drainage structures.

14.7.3.2 Flared/Divided Median Barriers

It may be necessary to intermittently divide a median barrier or to flare the barrier from one side to the other. A sloped median or a fixed object in the median may require this. The median barrier may be divided by one of these methods:

1. A fixed object may be encased by a CMB.
2. A half-section CMB may be used on both sides to shield a fixed object.
3. The cable median barrier can be split into two separate runs of offset barrier passing on either side of the median hazard (fixed object or slope).

If a median barrier is split, the designer should adhere to the suggested flare rates. See [Figure 14.6L](#). For the cable median barrier, use the rates presented for the semi-rigid system. The *SCDOT Standard Drawings* illustrate median barrier applications around fixed objects.

14.7.3.3 Terminal Treatments

As with roadside barrier terminals, median barrier terminals present a potential roadside hazard for run-off-the-road vehicles. Therefore, the designer must carefully consider the selection and placement of the terminal end. If practical, the median barrier should be extended into a wider median area. See the *SCDOT Standard Drawings* for design details.

14.7.3.4 Superelevation

[Section 11.3](#) discusses superelevation development for multilane divided facilities. Where a median barrier is present, the axis of rotation is typically about the two median edges. This will allow the median (and the barrier) to remain in a horizontal plane through the curve. See [Section 11.3](#) and the *SCDOT Standard Drawings* for more information.

14.7.3.5 Maintenance/Emergency Crossovers

[Section 15.7](#) discusses Department policies on the warrants and design of maintenance and emergency crossovers. If practical, these should be avoided where a median barrier is present. If a crossover must be provided, the barrier should be terminated as described in the *SCDOT Standard Drawings*. The width of the opening should be approximately 25 to 30 feet. This is wide enough to safely allow a maintenance or emergency vehicle to turn through, but it is narrow enough to minimize the possibility of a run-off-the-road vehicle passing through.

14.7.3.6 Barrier-Mounted Obstacles

If trucks or buses impact the CMB, their high center of gravity may result in a vehicular roll angle which possibly will allow the truck or bus to impact obstacles on top of the CMB (e.g., luminaire supports). If practical, move these devices to the outside, or provide additional distance between the barrier and obstacles (e.g., bridge piers).

14.7.4 Glare Screens

Headlight glare from opposing traffic can be bothersome and distracting. However, in lieu of commercial glare screens, the Department uses the “tall” CMB designs where headlight glare is considered a sufficiently severe problem to warrant attention. No specific warranting criteria have been adopted by the Department; however, glare treatment may be considered on, for example, urban freeways with narrow medians and high traffic volumes (especially high truck volumes).

14.8 IMPACT ATTENUATORS (Crash Cushions)

14.8.1 General

Impact attenuators (crash cushions) are protective systems that prevent errant vehicles from impacting hazards by either decelerating the vehicle to a stop after a frontal impact or by redirecting it away from the hazard after a side impact. They operate on the basis of energy absorption. Impact attenuators are adaptable to many roadside hazard locations where longitudinal barriers cannot practically be used.

14.8.2 Warrants

Impact attenuator warrants are the same as barrier warrants. Once a hazard is identified, the designer should first attempt to remove, relocate or make the hazard break away. If the foregoing is impractical, then an impact attenuator should be considered.

Impact attenuators are most often installed to shield fixed-point hazards which are close to the traveled way and where head-on impacts (as opposed to side impacts) are probable. Examples include exit gore areas (particularly on structures), bridge piers and median barrier ends. Impact attenuators are often preferable to a roadside barrier to shield these hazards. Site conditions and costs will determine whether to use a barrier or impact attenuator.

14.8.3 Impact Attenuator Types

Contact the manufacturer for detailed information on specific impact attenuator installations. The designer should note that all of the operational systems are patented.

Impact attenuators operate on the principle of absorbing the energy of the vehicle through the use of bays or modules filled with crushable or plastically deformable materials. Some energy is also absorbed by the vehicle as the front end of the vehicle is crushed on impact. Impact attenuators of this type require a rigid back-up support to contain the forces created by the deformation of the device. Most devices of this type capture the vehicle in a frontal impact. For side impacts, the vehicle is smoothly redirected by means of side panels and/or cables. Vertical and lateral restraint of the device is also required.

14.8.4 Impact Attenuator Selection

The selected impact attenuator must be compatible with the specific site characteristics. Often, more than one of the operational systems will be adaptable to the site.

Therefore, the designer must exercise judgment in impact attenuator selection considering:

- type and width of hazard;
- space available for installation of the system (see [Figure 14.8A](#));
- whether the hazard to be shielded is located in a high- or low-risk impact area;
- initial, maintenance and restoration costs; and
- ease or difficulty of restoration of the system after impact.

Although [Figure 14.8A](#) depicts a gore location, the same recommendations will generally apply to other types of fixed objects that require shielding. The “unrestricted” conditions represent the minimum dimensions for all locations except for those sites where it can be demonstrated that the increased costs for obtaining these dimensions (as opposed to those for “restricted” conditions) will be unreasonable. The “preferred” condition dimensions should be considered optimum. The information provided in this Figure is generic and may not be adequate for some systems. Therefore, it is recommended that the designer examine the various available systems that will adequately shield the obstacle and determine the space requirements from the manufacturer’s specifications.

14.8.5 Impact Attenuator Design

Once an impact attenuator has been selected, the designer must insure that its design is compatible with the traffic and physical conditions at the site. The following Sections will provide criteria for the basic input parameters into impact attenuator design. The designer should contact the manufacturer of the system for the detailed design of the impact attenuator.

14.8.5.1 Deceleration

For all safety appurtenances, acceptable vehicular deceleration is determined by the occupant impact velocity as measured from full-scale crash tests. All impact attenuators must meet the following parameters for occupant reaction:

1. Vehicular Weight. The impact attenuator must accommodate vehicles weighing between 1800 and 4500 pounds.
2. Vehicular Speeds. For freeways, use the design speed of the facility. For rural non-freeways, use the design speed of the facility with a minimum of 50 miles per hour. For urban non-freeways, use the design speed of the facility with a minimum of 40 miles per hour.

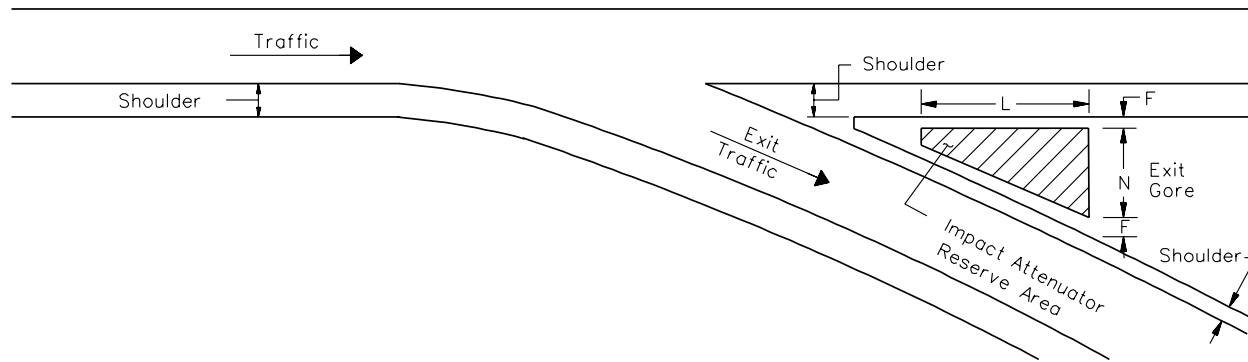
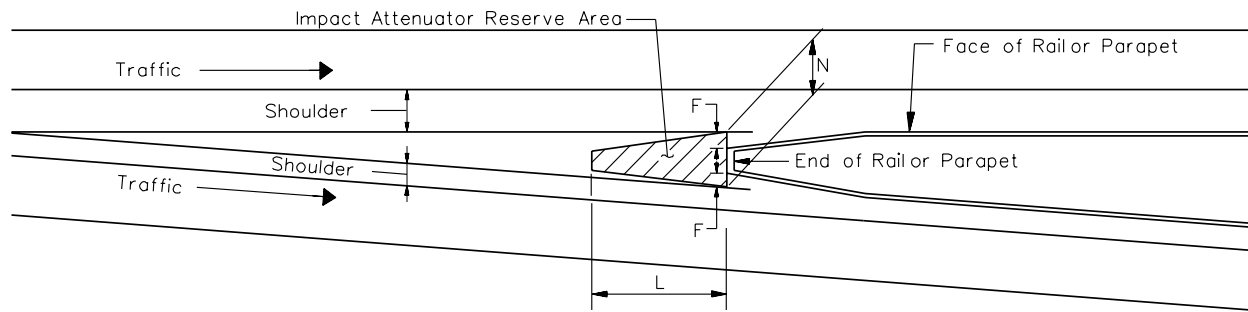

Design Speed On Mainline (mph)	Dimensions for Impact Attenuator Reserve Area (ft)								
	Minimum						Preferred		
	Restricted Conditions			Unrestricted Conditions					
	N	L	F	N	L	F	N	L	F
30	6	8	2	8	11	3	12	17	4
50	6	17	2	8	25	3	12	33	4
70	6	28	2	8	45	3	12	55	4

RESERVE AREA FOR IMPACT ATTENUATORS

Figure 14.8A

3. Deceleration Forces (Occupant Reaction). Acceptable vehicular deceleration is determined by the occupant impact velocity as measured from full-scale crash tests. Currently, the acceptable limits of performance are based on NCHRP 350 *Recommended Procedures for the Safety Performance Evaluation of Highway Features*. The manufacturer is responsible for designing the impact attenuator to meet the current national performance criteria.

14.8.5.2 Placement

Several factors should be considered in the placement of an impact attenuator:

1. Level Terrain. All impact attenuators have been designed and tested for level conditions. Vehicular impacts on devices placed on a non-level site could result in an impact at the improper height which could produce undesirable vehicular behavior. Therefore, the attenuator should be placed on a level surface or on a cross slope not to exceed 5 percent.
2. Curbs. No curbs should be present on new projects at impact attenuator installations. On existing highways, all curbs higher than 4 inches should be removed at proposed installations if feasible.
3. Surface. A paved, bituminous or concrete pad should be provided under the impact attenuator. The base should be 2 feet wider than the array.
4. Orientation. The impact attenuator should be oriented to accommodate the probable impact angle of an encroaching vehicle. This will maximize the likelihood of a head-on impact. However, this is not as important for impact attenuators with redirective capability. The proper orientation angle will depend upon the design speed, roadway alignment and lateral offset distance to the attenuator. A maximum angle of approximately 10 degrees, as measured between the highway and impact attenuator longitudinal centerlines, is considered appropriate.
5. Location. The system must not infringe on the traveled way. There should be a minimum of 2 feet between the attenuator system and the hazard to allow access to the system.
6. Bridge Joints. Avoid the placement of impact attenuators over bridge expansion joints or deflection joints in deep superstructures because movement in these joints could create destructive strains on the system's anchor cables.
8. Transitions. Transitions between systems and backwalls, bridge rails or other objects should be smoothly shaped to lessen the possibility of vehicular

snagging. The yielding characteristics of the system should be considered when determining the transition.

14.9 REFERENCES

1. *Roadside Design Guide*, AASHTO, 2002.
2. *Guide for Selecting, Locating, and Designing Traffic Barriers*, AASHTO, 1977.
3. *A Supplement to A Guide for Selecting, Locating, and Designing Traffic Barriers*, Texas Transportation Institute, March 1980.
4. *Safety Design and Operational Practices for Streets and Highways*, FHWA, March 1980.
5. "A Roadside Design Procedure," James Hatton, Federal Highway Administration, January 1974.
6. NCHRP 150 *Effect of Curb Geometry and Location on Vehicle Behavior*, Transportation Research Board, 1974.
7. NCHRP 158 *Selection of Safe Roadside Cross Sections*, Transportation Research Board, 1975.
8. NCHRP 350 *Recommended Procedures for the Safety Performance Evaluation of Highway Features*, Transportation Research Board, 1993.

Table of Contents

<u>Section</u>	<u>Page</u>
15.1 DEFINITIONS.....	15.1(1)
15.2 GENERAL DESIGN CONTROLS.....	15.2(1)
15.2.1 General Design Considerations.....	15.2(1)
15.2.2 Intersection Types.....	15.2(2)
15.2.3 Intersection Spacing.....	15.2(4)
15.2.4 T-Intersections.....	15.2(7)
15.2.5 Design Vehicles.....	15.2(7)
15.2.5.1 Types.....	15.2(7)
15.2.5.2 Selection.....	15.2(7)
15.2.6 Intersection Alignment.....	15.2(9)
15.2.6.1 Horizontal Curves.....	15.2(9)
15.2.6.2 Angle of Intersection.....	15.2(10)
15.2.6.3 Offset Intersection Legs.....	15.2(10)
15.2.7 Intersection Profiles.....	15.2(12)
15.2.7.1 Gradient.....	15.2(12)
15.2.7.2 Cross Slope Transitions.....	15.2(12)
15.2.7.3 Vertical Profile.....	15.2(15)
15.2.7.4 Drainage.....	15.2(17)
15.2.8 Capacity and Level of Service.....	15.2(17)
15.2.9 Signalized Intersections.....	15.2(17)
15.2.10 Intersection Sight Distance.....	15.2(18)
15.3 TURNING RADII.....	15.3(1)
15.3.1 Types of Corner Radii.....	15.3(1)
15.3.2 Right-Turn Designs.....	15.3(1)
15.3.2.1 Design Considerations.....	15.3(1)
15.3.2.2 Corner Radii Selection Guidelines.....	15.3(5)
15.3.3 Left-Turn Designs.....	15.3(5)

Table of Contents
(Continued)

<u>Section</u>	<u>Page</u>
15.4 TURNING ROADWAYS	15.4(1)
15.4.1 Types of Turning Roadways	15.4(1)
15.4.2 Guidelines	15.4(1)
15.4.3 Design Criteria	15.4(2)
15.4.4 Width	15.4(2)
15.5 AUXILIARY TURN LANES	15.5(1)
15.5.1 Turn Lane Guidelines	15.5(1)
15.5.1.1 Guidelines for Right-Turn Lanes	15.5(1)
15.5.1.2 Guidelines for Left-Turn Lanes	15.5(1)
15.5.2 Design of Turn Lanes	15.5(10)
15.5.2.1 Widths	15.5(10)
15.5.2.2 Turn Lane Lengths	15.5(10)
15.5.3 Typical Turn Lane Treatments	15.5(13)
15.5.4 Dual-Turn Lanes	15.5(17)
15.5.4.1 Guidelines	15.5(17)
15.5.4.2 Design	15.5(17)
15.5.5 Acceleration Lanes	15.5(19)
15.6 CHANNELIZATION	15.6(1)
15.6.1 Functional Types	15.6(1)
15.6.2 Selection of Channelization	15.6(1)
15.6.2.1 Flush Channelization	15.6(2)
15.6.2.2 Raised Channelization	15.6(2)
15.6.3 Size	15.6(2)
15.6.4 Offset to Through Lanes	15.6(3)
15.6.5 Delineation	15.6(3)
15.6.6 Concrete Island in Flush Median	15.6(3)

Table of Contents
(Continued)

<u>Section</u>	<u>Page</u>
15.7 MEDIAN OPENINGS.....	15.7(1)
15.7.1 Location.....	15.7(1)
15.7.2 Design	15.7(3)
15.8 RAILROAD/HIGHWAY GRADE CROSSINGS	15.8(1)
15.8.1 Railroad Crossings Near Intersections	15.8(1)
15.8.2 Interconnection Traffic Signal System Design	15.8(2)
15.8.2.1 General.....	15.8(2)
15.8.2.2 Coordination	15.8(2)
15.8.3 Sight Distance	15.8(2)
15.8.4 Horizontal Alignment	15.8(3)
15.8.5 Vertical Alignment.....	15.8(3)
15.8.6 Grade Crossing Surface	15.8(3)
15.9 REFERENCES	15.9(1)

Chapter Fifteen

INTERSECTIONS

This Chapter discusses the geometric design of at-grade intersections including intersection alignment and profile, turning radii, turning roadways, turning lanes, channelization, median openings and at-grade railroad crossings. Intersection sight distance is discussed in [Chapter 10](#). The intersection is an important part of the highway system. The operational efficiency, capacity, safety and cost of the system depend largely upon its design, especially in urban areas. The primary objective of intersection design is to reduce potential conflicts between vehicles, bicycles and pedestrians while providing for the convenience, ease and comfort of those traversing the intersection.

15.1 DEFINITIONS

1. Approach. A road providing access from a public way to a highway, street or road to an abutting property.
2. Channelization Islands. Channelization islands control and direct traffic movements and guide the driver into the proper channel. Traffic is generally passing in the same direction on both sides of the island.
3. Channelization. The directing of traffic through an intersection by the use of pavement markings (including striping, raised reflectors, etc.) for divisional or directional islands.
4. Comfort Criteria. Criteria that is based on the comfort effect of change in vertical direction in a sag vertical curve because of the combined gravitational and centrifugal forces.
5. Corner Island. A raised or painted island to channel the right-turn movement.
6. Curb Return. The circular segment of curb at an intersection that connects the tangent portions of the intersecting legs.
7. Design Vehicle. The vehicle used to determine turning radii, off-tracking characteristics, pavement designs, etc., at intersections.
8. Divisional Islands. Divisional islands segregate opposing traffic flows, alert the driver to the cross road ahead and regulate traffic through the intersection.
9. Grade Separation. A crossing of two highways, or a highway and a railroad, at different levels.

10. Interchange. A system of ramps in conjunction with one or more grade separations, providing for the movement of traffic between two or more roadways on different levels.
11. Intersection Sight Distance (ISD). The sight distance required within the corners of intersections to safely allow a variety of vehicular access or crossing maneuvers based on the type of traffic control at the intersection.
12. Intersection. The general area where two or more highways join or cross at grade.
13. Landing Area. The area approaching an intersection for stopping and storage of vehicles.
14. No Control Intersection. An intersection where none of the legs are controlled by a traffic control device.
15. Radius Return. The point along the mainline pavement edge where the curb return of an intersection meets the tangent portion, or a point tangent to a mainline curve.
16. Refuge Island. Corner or divisional islands that function to aid and protect pedestrians and bicyclists who cross a wide roadway.
17. Signalized Intersection. An intersection where all legs are controlled by a traffic signal.
18. Stop-Controlled Intersection. An intersection where one or more legs are controlled by a stop sign.
19. Turn Lane. An auxiliary lane adjoining the through traveled way for speed change, storage and turning.
20. Turning Roadway. A channelized roadway (created by an island) connecting two legs of an at-grade intersection. Interchange ramps are not considered turning roadways.
21. Turning Template. A graphic representation of a design vehicle's turning path depicting various angles of turns for use in determining acceptable turning radii designs.
22. Yield-Controlled Intersection. An intersection where one or more legs are controlled by a yield sign.

15.2 GENERAL DESIGN CONTROLS

15.2.1 General Design Considerations

In every intersection design, there are many conflicting requirements that must be balanced against each other to produce a safe and efficient design. The basic elements that must be taken into consideration include:

1. Human Factors. These include:

- driving habits,
- ability to make decisions,
- driver expectancy,
- decision and reaction time,
- conformance to natural paths of movement,
- pedestrian use and habits, and
- bicycle traffic use and habits.

Intersections should be as simple as practical to minimize the number of possible conflicts and to avoid subsequent confusion and demands on drivers to recognize and rapidly react to complex situations.

2. Traffic Considerations. These include:

- capacity and actual traffic volumes,
- ADT and/or DHV,
- vehicular composition,
- turning movements,
- vehicular speeds (design and operating),
- transit involvement,
- crash history, and
- bicycle and pedestrian movements.

Road Data Services will provide the ADT and DHV for current and future year projections, including turning movement volumes.

3. Physical Elements. These include:

- character and use of abutting property,
- right of way,
- coordination of vertical profiles of the intersecting roads,
- coordination of horizontal and vertical alignment for intersections on curves,
- available sight distance,
- intersection angle,
- conflict area,
- geometric design,

- channelization,
 - traffic control devices,
 - lighting,
 - safety features,
 - bicycle and pedestrian traffic,
 - environmental impact, and
 - drainage requirements.
4. Economic Factors. These include:
- cost of improvements,
 - effects of controlling access to adjacent property, and
 - impact on fuel usage.
5. Functional Intersection Area. An intersection can be defined by both its functional and physical areas. These are illustrated in [Figure 15.2A](#). The functional area of the intersection extends both upstream and downstream from the physical intersection area and includes any auxiliary lanes and their associated channelization.

The functional area on the approach to an intersection consists of the following three basic elements and are shown in [Figure 15.2B](#):

- perception-reaction distance,
- maneuver distance, and
- queue-storage distance.

15.2.2 Intersection Types

Intersections are usually a three-leg, four-leg or multi-leg design. Individual intersections may vary in size and shape and may be channelized. The principal design factors that affect the selection of intersection type and its design characteristics are discussed in [Section 15.2.1](#). Selection of the intersection type will be determined on a site-by-site basis.

Multi-leg intersections are those with five or more intersection legs. Avoid using multi-leg intersections. Wherever practical, rearrange the legs to remove conflicting movements. This may be accomplished by realigning one or more of the intersecting legs and combining some traffic movements at adjacent subsidiary intersections.

A roundabout is a channelized intersection where traffic moves around a center island, counter-clockwise. For additional guidance on the selection and design of roundabouts, the designer should review the FHWA publication, *Roundabouts: An Information Guide*. Copies of this document are available from the Turner-Fairbank Highway Research Center.

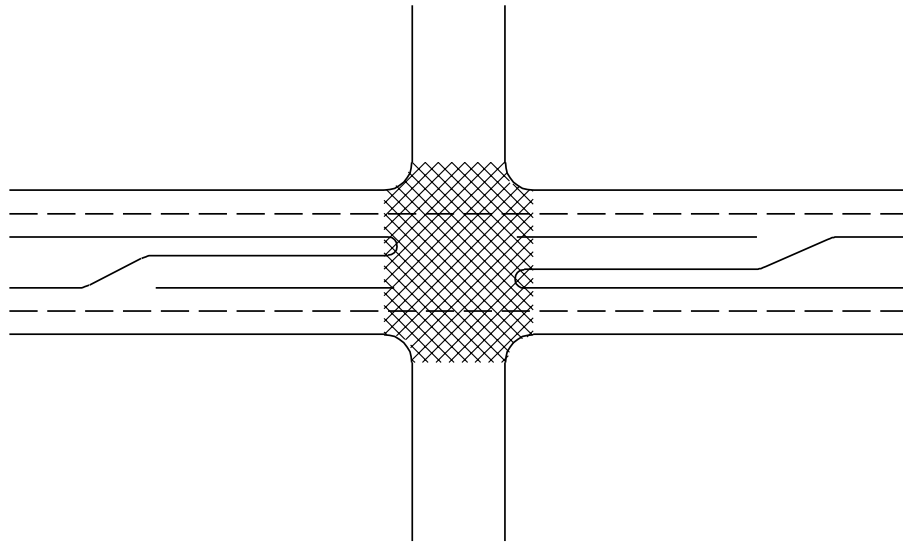

PHYSICAL AREA

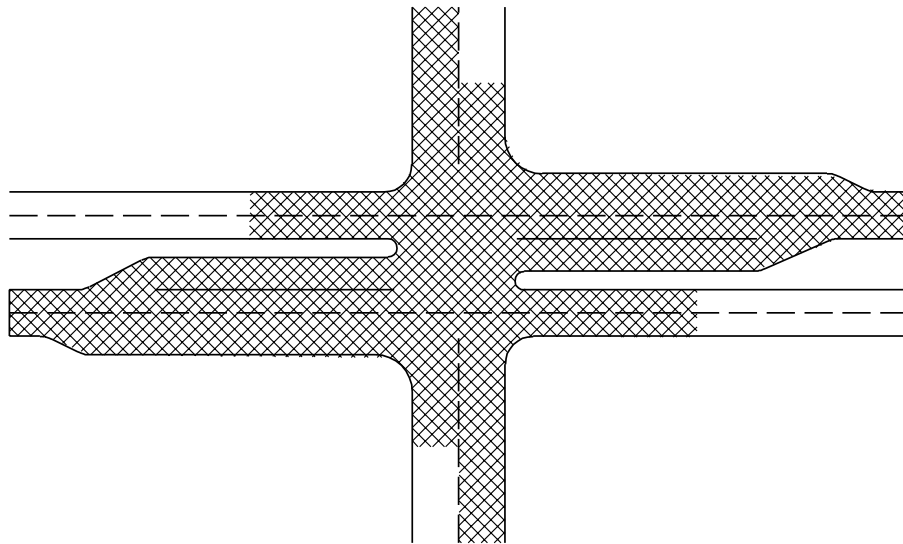

FUNCTIONAL INTERSECTION AREA

PHYSICAL AND FUNCTIONAL INTERSECTION AREA

Figure 15.2A

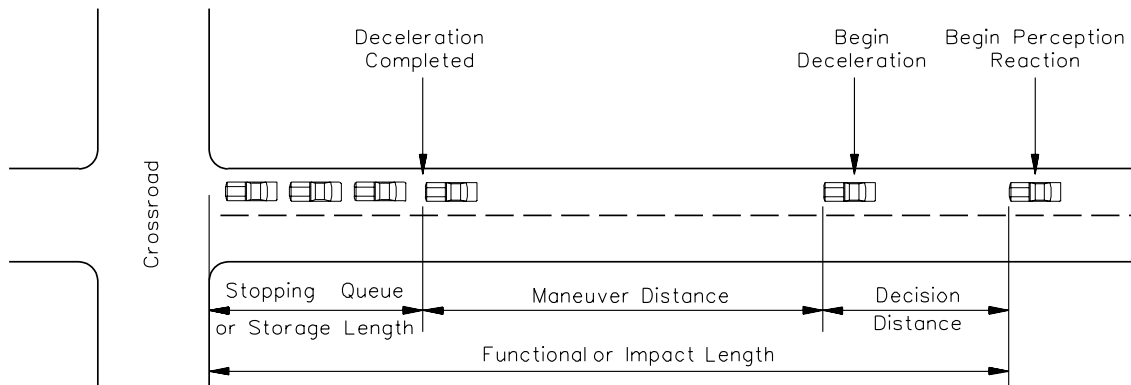

ELEMENTS OF THE FUNCTIONAL AREA OF AN INTERSECTION

Figure 15.2B

15.2.3 Intersection Spacing

If practical, avoid short distances between intersections because they tend to impede traffic operations. For example, if two intersections are close together and require signalization, they may need to be considered as one intersection for signalization purposes. To operate safely, each leg of the intersection may require a separate green phase, thereby greatly reducing the capacity for both intersections. Short spacing between intersections may hinder or even restrict effective left-turn movements. Where practical, realign the roadways to form a single intersection.

To operate efficiently, urban intersections should be a minimum of 500 feet apart. For rural areas, provide a minimum spacing of $\frac{1}{4}$ mile and, desirably, $\frac{1}{2}$ mile apart. Generally, treat signalized and unsignalized intersections the same. Because of changing traffic patterns, development and crash concerns, unsignalized intersections may be converted to signalized intersections in the future. Conduct a capacity analysis to determine if free-flow can be obtained between the intersections.

In addition, avoid short gaps between opposing "T" intersections. Drivers tend to encroach into the opposing lanes (corner cutting) so that they can make their turning maneuvers in one movement. In general, all new intersections should preferably be at least 500 to 700 feet apart. See [Section 15.2.6.3](#) and [Figure 15.2C](#) for additional guidance.

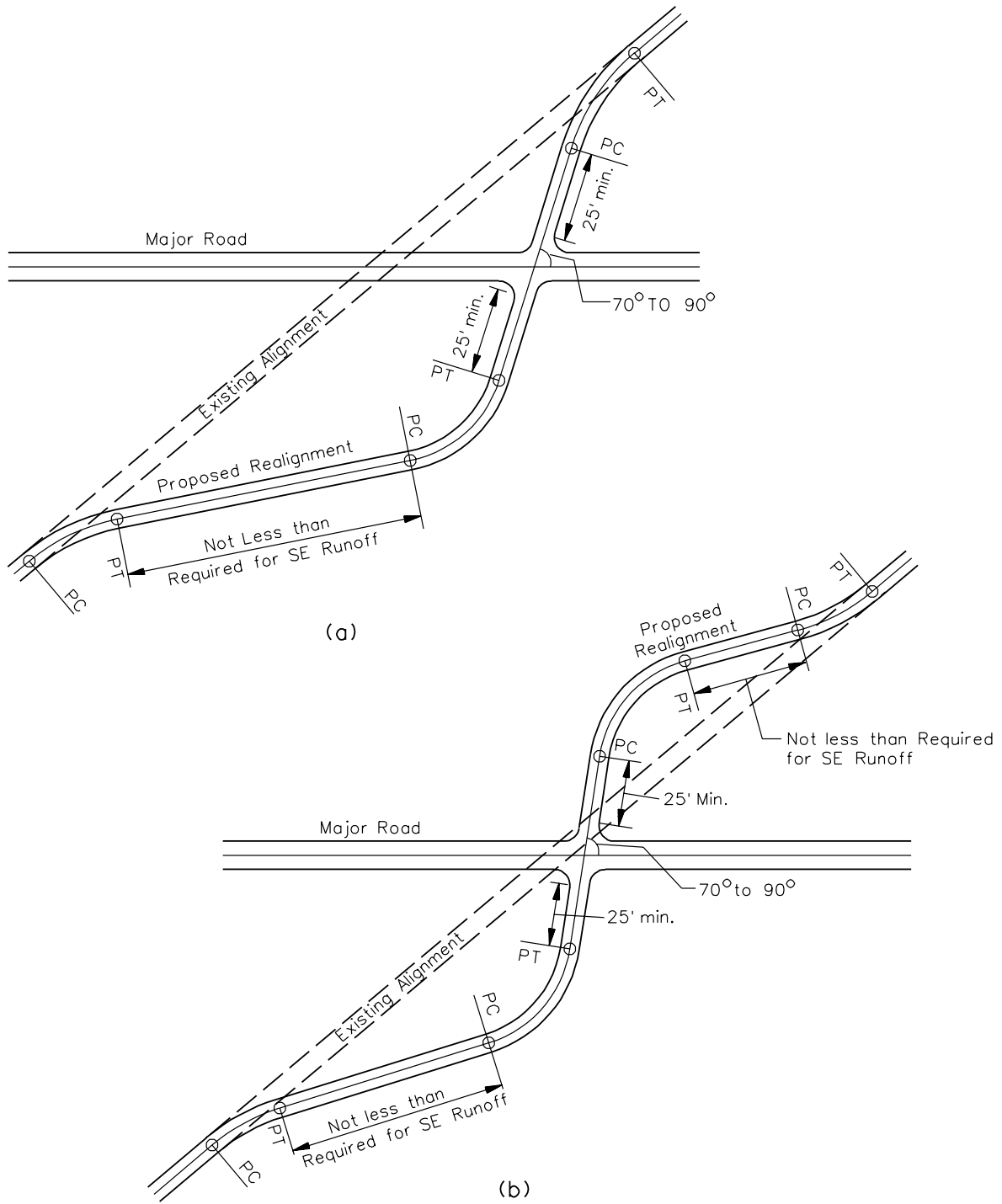

REALIGNMENT OF INTERSECTIONS

Figure 15.2C

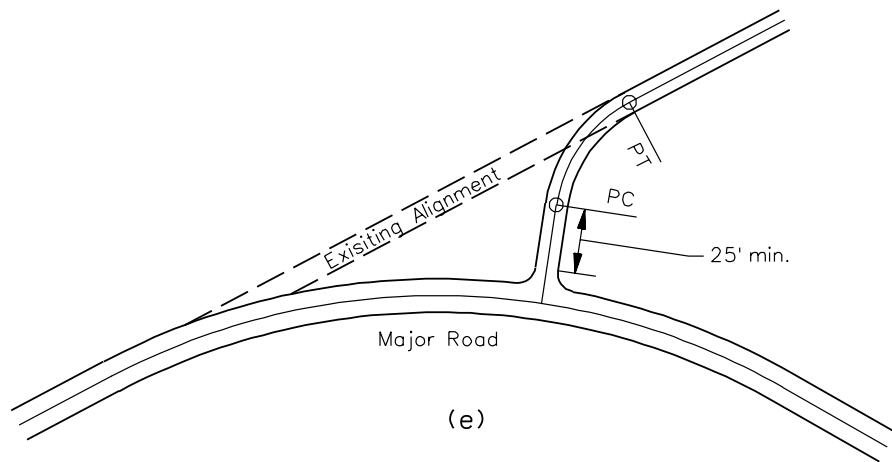
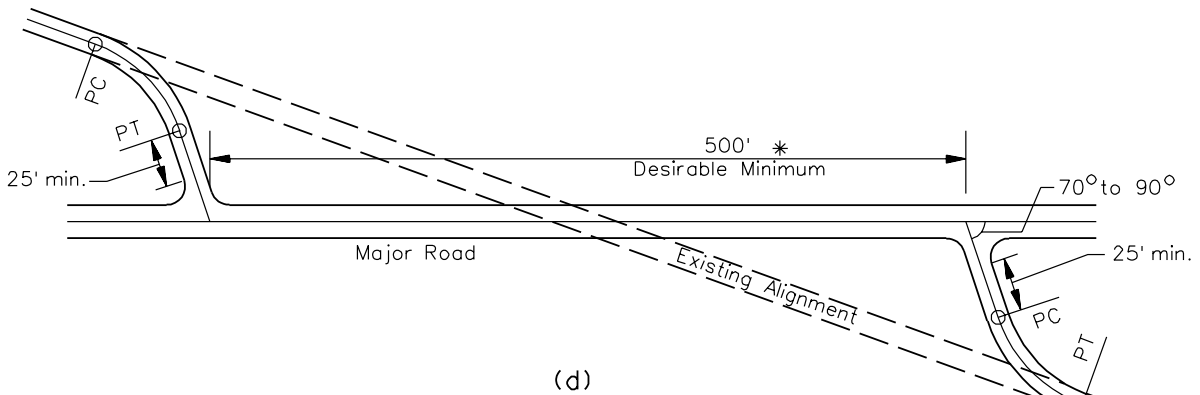
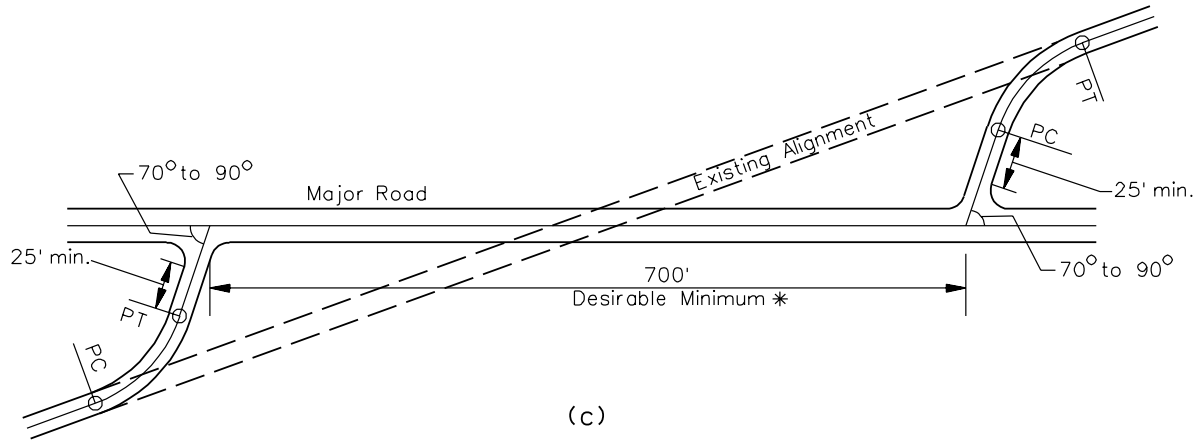

* Distance between intersections as required by a capacity analysis.

REALIGNMENT OF INTERSECTIONS

Figure 15.2C
(Continued)

15.2.4 T-Intersections

Where a roadway intersects with another road in a T-configuration, consider the following design criteria:

1. Design Speed. If a horizontal curve of the road being designed is adjacent to the intersection, review the roadway's design speed against the stop condition. If the design speed cannot be obtained due to the alignment, mark the plans "NA" to indicate that the design speed will not be applicable for this situation.
2. End of Roadway Restriction. If a horizontal curve is too close to the end of the roadway and the recommended superelevation and transition length cannot be obtained, then the horizontal alignment design criteria will not be applicable.
3. No Restrictions. If there is no end of roadway restriction, design the horizontal curve with the proper design speed and transition. Do not mark the plans with "NA." If the alignment does not meet the selected design speed, then obtain a design exception; see [Section 9.2](#). Do not mark the plans "NA" if a design exception is required.

15.2.5 Design Vehicles

15.2.5.1 Types

The basic design vehicles that may be used for intersection designs in South Carolina include:

1. SU — Single-unit truck or small bus.
2. BUS/S-BUS — Transit/School bus.
3. WB-50 — Semitrailer combination.
4. WB-62 — Semitrailer combination.
5. MH/B — Recreational vehicle, motor home with boat trailer.

[Section 9.7](#) provides the design details for these vehicles. The turning characteristics of the applicable design vehicle are used to test the adequacy of an existing or proposed design at an intersection. The turning characteristics can be checked with turning templates (e.g., *AASHTO A Policy on Geometric Design of Highways and Streets*) or with a computer-simulated turning template program.

15.2.5.2 Selection

[Figure 15.2D](#) presents the recommended design vehicles at intersections based on the functional classification of the intersecting highways that the vehicle is turning from and onto. The design vehicles shown in [Figure 15.2D](#) are for new construction and reconstruction projects.

For Turn Made		Design Vehicle
From	Onto	
Freeway Ramp	Other Facilities	WB-62
Other Facilities	Freeway Ramp	WB-62
Arterial	Arterial	WB-62
	Collector	WB-62
	Local	WB-62
	Local (Residential)	SU/S-BUS*
Collector	Arterial	WB-62
	Collector	WB-62
	Local	WB-62
	Local (Residential)	SU/S-BUS*
Local	Arterial	WB-62
	Collector	WB-62
	Local	SU/S-BUS*
	Local (Residential)	SU/S-BUS
Local (Residential)	Arterial	SU/S-BUS*
	Collector	SU/S-BUS*
	Local	SU/S-BUS
	Local (Residential)	SU/S-BUS

**With encroachment, a WB-50 vehicle should physically be able to make the turn.*

Note: Use this figure as a guide for new construction and reconstruction projects.

SELECTION OF DESIGN VEHICLE AT INTERSECTIONS

Figure 15.2D

In addition to [Figure 15.2D](#), use the following guidelines when selecting a design vehicle:

1. **Minimum Designs.** The SU and/or school bus design vehicles are generally the smallest vehicles used in the design of highway intersections. This design reflects that, even in residential areas, garbage trucks, delivery trucks and school buses will be negotiating turns with some frequency. Rural and suburban intersections, which may serve school bus traffic, should, at a minimum, accommodate a turning school bus without encroachment outside of the traveled way. Intersections only need to accommodate design vehicles that are expected to use that intersection.
2. **Recreational Areas.** Recreational areas typically will be designed using the SU design vehicle. This reflects that service vehicles are typically required to maintain the recreational area. Under some circumstances, the motor home with a boat trailer (MH/B) may be the appropriate design vehicle (e.g., campground areas, boat launches).
3. **Mixed Use.** Some portions of an intersection may be designed with one design vehicle and other portions with another vehicle. For example, it may be desirable to design physical characteristics (e.g., corner islands) for the WB-62 truck but provide painted channelization for the SU design vehicle.

15.2.6 Intersection Alignment

15.2.6.1 Horizontal Curves

Preferably, an intersection between two roadways should be on tangent sections. When a minor road intersects a major road on a horizontal curve, the geometric design of the intersection becomes significantly more complicated, particularly for sight distance, turning movements, crossing movements, channelization and superelevation. The following guidelines address horizontal alignment at intersections:

1. **Realignment.** If relocation of the intersection beyond the horizontal curve is not practical, the designer may be able to realign the minor road to intersect the major road perpendicular to a tangent on the horizontal curve; see example (e) in [Figure 15.2C](#). Although an improvement, this arrangement may still result in difficult turning movements due to superelevation on the major road.
2. **Superelevated Mainline.** If the mainline is on a horizontal curve, the mainline superelevation rate must be minimized so that slowing or stopped vehicles do not slide across the pavement during wet or icy conditions.
3. **Curved Approach.** Where a highway or street is on a curved alignment and is approaching a stop condition, special consideration is required in the design of the horizontal curvature prior to the intersection.

15.2.6.2 Angle of Intersection

Highways should intersect at or nearly at right angles. Intersections at acute angles are undesirable because they:

- restrict vehicular turning movements,
- require additional pavement and channelization for large trucks,
- increase the exposure time for vehicles and pedestrians crossing the main traffic flow, and
- restrict the crossroad sight distance.

Preferably, the angle of intersection should be within 20 degrees of the perpendicular. This amount of skew can often be tolerated because the impact on sight lines and turning movements is not significant. Under restricted conditions where obtaining the right of way to straighten the angle of intersection would be impractical, an intersection angle up to 30 degrees from the perpendicular may be used. Where turning movements are significantly unbalanced, the intersections may be angled to favor the predominant movement. Intersection angles beyond these ranges may warrant more positive traffic control (e.g., all stop, traffic signals) or geometric improvements (e.g., realignment, greater corner sight distance).

[Figure 15.2C](#) illustrates various angles of intersection and potential improvements that can be made to the alignment. Avoid using short-radius curves or unnatural travel paths near the intersection simply to reduce the intersection skew. The designer should consider visibility of traffic control devices during the design to meet *MUTCD* criteria.

15.2.6.3 Offset Intersection Legs

In general, four-leg intersections should be designed so that opposing approaches line up with each other (i.e., there is no offset between opposing approaches). However, this is not always practical. [Figure 15.2E](#) presents a diagram of an intersection with an offset between opposing approaches. Because of possible conflicts with overlapping turning vehicles, offset intersections should only be allowed to remain on low-volume approaches. The following criteria will apply for offset intersection approaches:

1. Maximum Offset. The maximum offset is determined from the application of a taper equal to V:1 applied to the intersection width, where V is the design speed in miles per hour; see [Figure 15.2E](#). V is selected as follows:
 - $V = 20$ miles per hour for stop-controlled approaches.
 - $V =$ the roadway design speed for the free-flowing approaches at a stop-controlled intersection.
 - $V =$ the roadway design speed for the offset approaches at a signalized intersection.

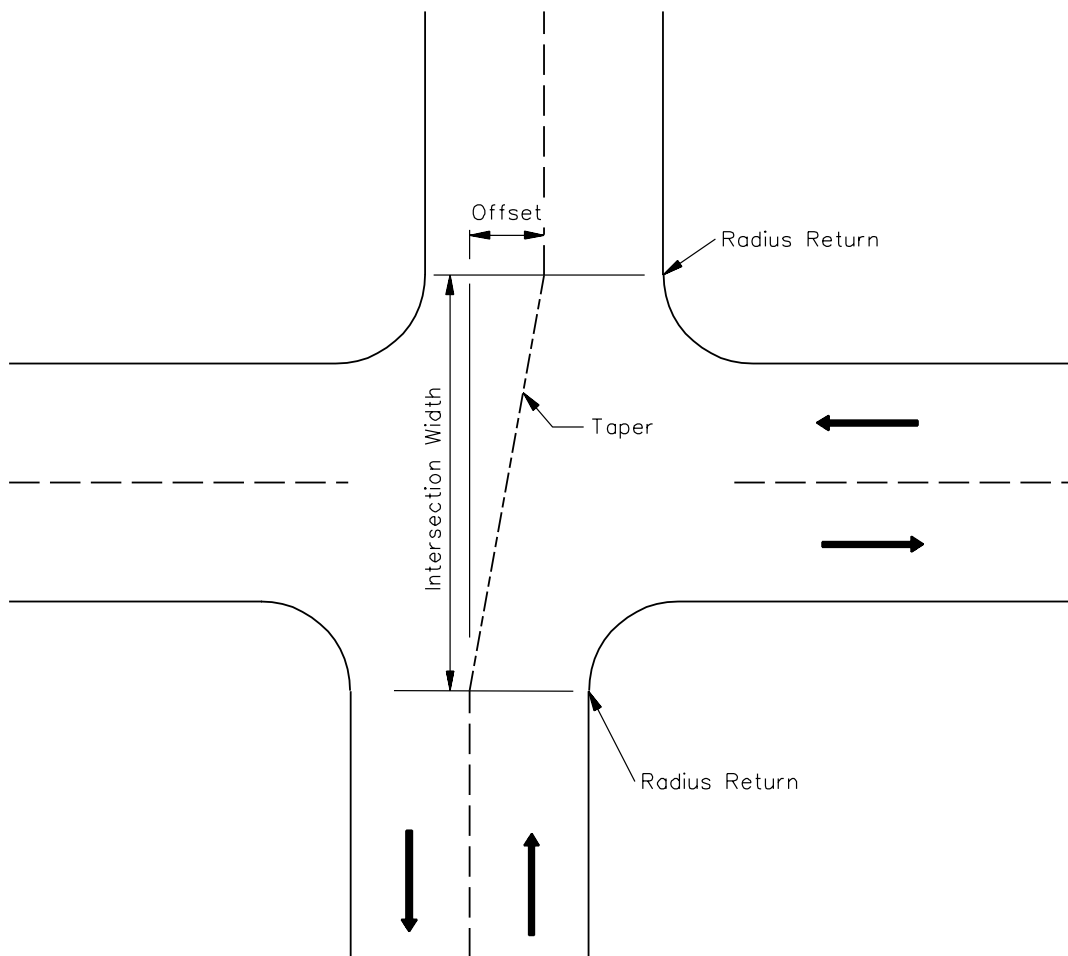

Design Speed (mph)	Allowable Offset (ft)	
	Crossing a 2-Lane Street ⁽¹⁾	Crossing a 5-Lane Street ⁽²⁾
20 ⁽³⁾	3.7	7.2
25	3.0	5.7
30	2.5	4.8
35	2.1	4.1
40	1.9	3.6
45	1.6	3.2
50	1.5	2.9
55	1.3	2.6
60	1.2	2.4

1. Assumes a 25-foot corner radius and two 12-foot lanes (i.e., 74 feet).
2. Assumes a 40-foot corner radius, four 12-foot lanes and a 15-foot TWLTL (i.e., 143 feet).
3. Use the 20-mile per hour design speed for all stopped approaches.
4. See discussion in [Section 15.2.6.3](#) for more information.

OFFSET INTERSECTION LEGS

Figure 15.2E

2. Turning Conflicts. Evaluate the entire intersection for conflicts that may result from turning vehicles at an offset intersection. For example, offsets where the “jog” is to the left may result in significant interference between simultaneous left-turning vehicles.
3. Evaluation Factors. In addition to potential vehicular conflicts, the designer should evaluate the following at existing or proposed offset intersections:
 - through and turning volumes;
 - type of traffic control;
 - impact on all turning maneuvers;
 - intersection geometrics (e.g., sight distance, curb/pavement edge radii); and
 - crash history at existing intersections.

Where existing offset intersections are being considered to remain-in-place, the designer should coordinate the intersection design and traffic control requirements with the Traffic Engineering Division.

15.2.7 Intersection Profiles

15.2.7.1 Gradient

Vertical alignments through intersections should be as flat as practical but consideration must be given to obtaining positive drainage. Intersection areas or landing areas in the range of 75 to 100 feet should be established for minor roads as shown in [Figures 15.2F](#) and [15.2G](#). The landing area is the portion of intersecting highways, local roads, and public and private approaches that are used for the storage of stopped vehicles. This landing area should provide for minimum grade changes to provide adequate sight distance and minimize acceleration time for vehicles using the crossroads. Desirably, the landing area will slope away from the intersection on a gradient not to exceed 3 percent, downward or upward. However, an upward sloping landing area should be avoided if practical, because this will require the stopped motorist to apply brakes while waiting to cross or turn. Where the use of grades less than 3 percent may be cost prohibitive, the designer may, with corresponding adjustments to other intersection design elements, use an approach gradient up to 5 percent.

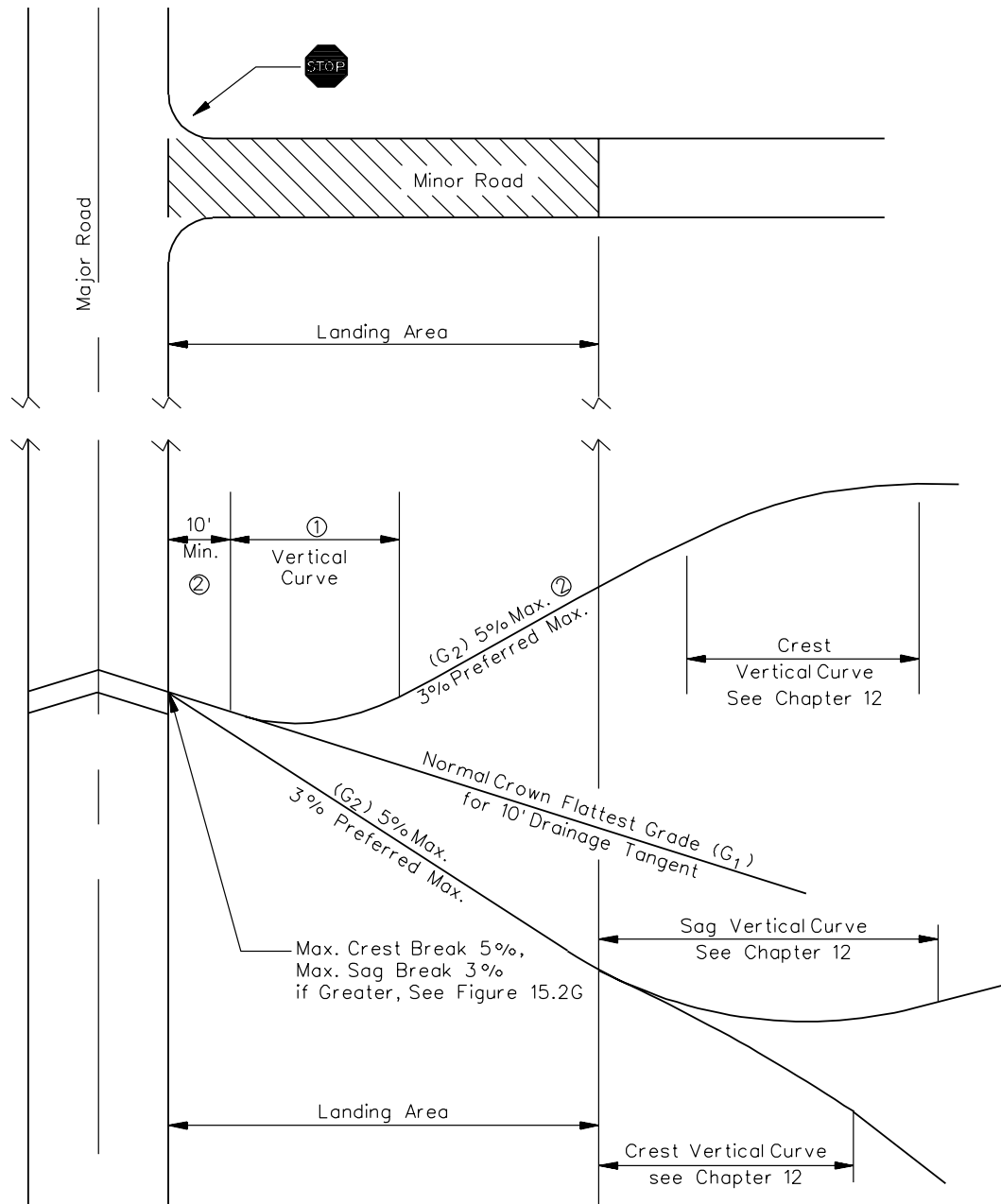

Notes:

- ① See [Section 15.2.7.3](#) for the vertical curve options.
- ② If practical, the gradient of the landing area where vehicles may be stored should not exceed 3 percent.
- ③ Actual field conditions will determine the final design.

**VERTICAL PROFILES OF INTERSECTING ROADS
(Tangent Section)**

Figure 15.2F

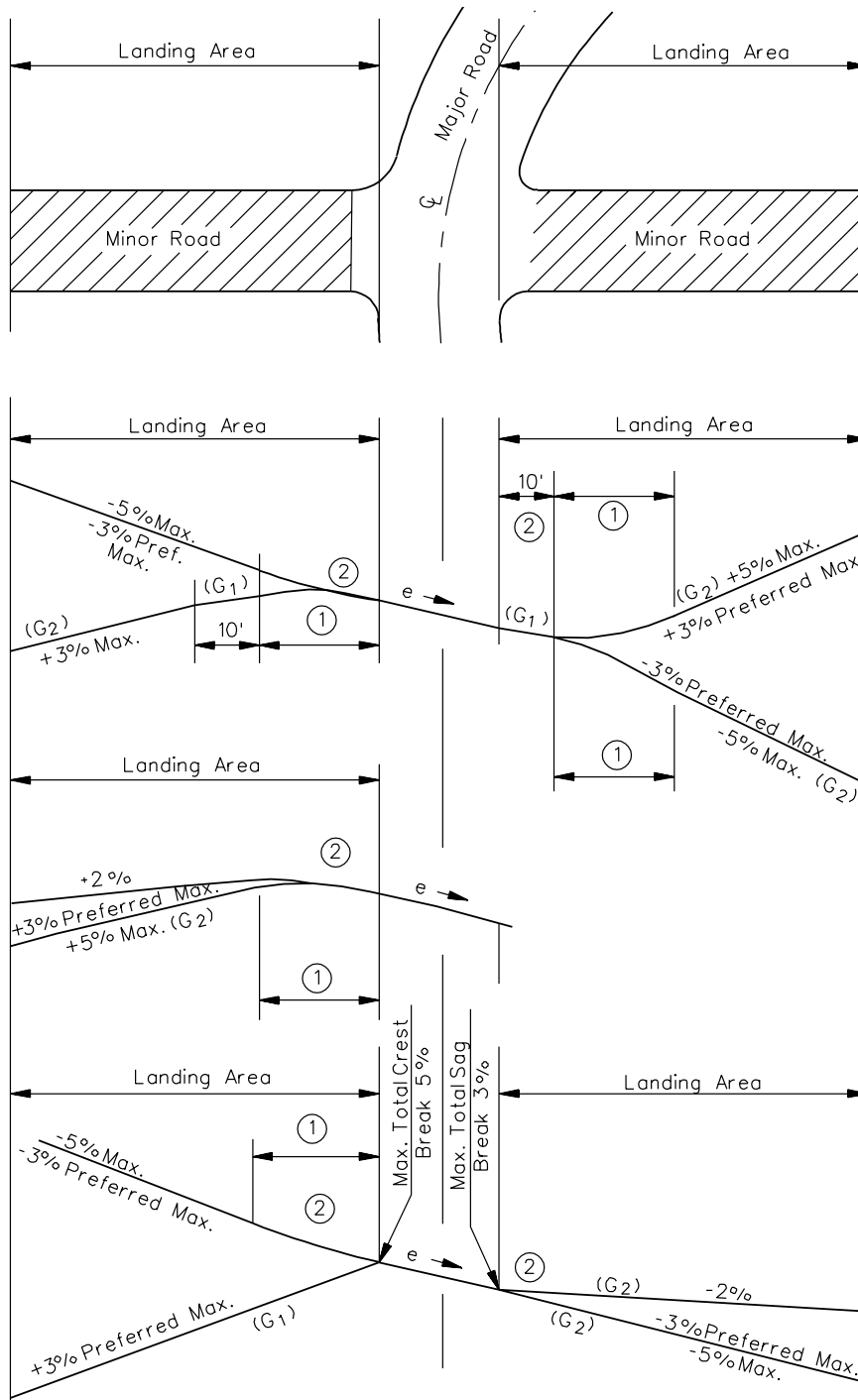

Notes:

- ① See [Section 15.2.7.3](#) for the vertical curve options.
- ② If practical, the gradient of the landing area where vehicles may be stored should not exceed 3 percent.
- ③ Actual field conditions will determine the final design.
- ④ For crest breaks exceeding 5 percent, use a vertical curve with a K -value of 3 or greater. For sag breaks exceeding 3 percent, round the break using a K -value of 5 or greater.

**VERTICAL PROFILE OF INTERSECTING ROADS
(Superelevated Section)**

Figure 15.2G

15.2.7.2 Cross Slope Transitions

One or both of the roadways approaching the intersection may need to be transitioned (or warped) to match or coordinate the cross slope and grade at the intersection. The designer should consider the following:

1. Stop Controlled. When the crossroad is stop controlled, maintain the profile and cross section of the major road through the intersection and transition the cross slope of the stop-controlled roadway to match the major road cross slope and profile.
2. Signalized Intersection. At signalized intersections, or potential signalized intersections, transition the cross slope of the crossroad to meet the profile and cross slope of the major road. If both intersecting roads have approximately equal importance, the designer may want to consider transitioning both roadways to form a plane section through the intersection. Where compromises are necessary between the two major roadways, provide the smoother riding characteristics to the roadway with the higher travel speeds.
3. Transition Distance. In rural areas, transitioning from the normal crown to a warped section should be accomplished in a distance of 50 feet. The 50-foot transition length is also desirable for urban areas but, at a minimum, the transition may be accomplished within the curb return.

15.2.7.3 Vertical Profile

Where the profile of the crossroad is adjusted to meet the major road, this will result in angular breaks for traffic on the crossroad if no vertical curve is inserted. The following options are presented in order from the most desirable to the least desirable; see [Figures 15.2F](#) and [15.2G](#):

1. Vertical Curves (SSD). Desirably, vertical curves will be used through an intersection which meet the criteria for stopping sight distance as described in [Chapter 12](#). For stop-controlled legs, design the approach landing vertical curve with a 20 to 30 mile-per-hour design speed. At free-flowing legs and at all legs of a signalized or proposed future signalized intersection, use the design speed of the roadway to design the vertical curve. The grades of the tangents for the vertical curve are the grade of the landing area (i.e., the cross slope of the major roadway) (G_1) and the profile grade of the crossroad (G_2); see [Figures 15.2F](#) and [15.2G](#). The Point of Vertical Tangency (PVT) will be located at a minimum of 10 feet from the major road traveled way.

2. Sag Vertical Curves (Comfort). For sag vertical curves, the next most desirable option is to design the sag to meet the comfort criteria. The length of vertical curve can be determined as follows:

$$L = \frac{AV^2}{46.5}$$

Equation 15.2.1

Where:

L = length of vertical curve, feet

A = algebraic difference between grades, percent

V = design speed, miles per hour

3. Vertical Curves (Minimum Comfort). Under restricted conditions where a design based on SSD or comfort is not practical, vertical curve length at intersection approaches may be based on [Equations 15.2.2 through 15.2.4](#):

$$K = (0.1V)^2 \quad (\text{Sag Curves})$$

Equation 15.2.2

$$K = (0.07V)^2 \quad (\text{Crest Curves})$$

Equation 15.2.3

$$L = KA$$

Equation 15.2.4

Where:

K = the horizontal distance in feet needed to produce a 1 percent change in the gradient along the curve

A = algebraic difference between the two tangent grades, percent

V = design speed, miles per hour

L = length of vertical curve, feet

4. Minimum Curves. At a minimum, provide a vertical curve of at least 20 feet in length between the landing and the approach gradient. This dimension is typically used to tie existing roadways/driveways along the project roadway. Generally, the intent is to tie the side roads within 100 to 200 feet of the major roadway.

15.2.7.4 Drainage

Evaluate the profile and transitions at all intersections for impacts on drainage. This is especially important for channelized intersections on curves and grades. This may require the designer to check superelevation transition lengths to insure that flat sections are minimized. Low points on approach roadway profiles should be beyond a raised corner island to prevent water from being trapped and causing ponding.

15.2.8 Capacity and Level of Service

A capacity analysis should be conducted before performing the detailed design of any intersection. This analysis will influence several geometric design features including the number of approach lanes, turning lanes, lane widths, channelization and number of departure lanes. The designer should select a level of service (LOS) and future design year, typically 20 years for new construction and major reconstruction projects. If the intersection is within the limits of a longer project, the design year for the intersection will be the same as that for the project.

LOS recommendations are provided in the geometric design tables in [Chapters 19 through 22](#). Once the LOS and design traffic volumes are determined, the designer should use the *Highway Capacity Manual* for the detailed capacity analysis. On request, the Traffic Engineering Division may perform this analysis.

15.2.9 Signalized Intersections

Traffic control signals are devices that control the movement of vehicles and pedestrians at intersections by assigning the right of way to various movements for certain pretimed or traffic-activated intervals of time. Signal control provides a key element in controlling the flow of traffic and movement of pedestrians on many urban streets and some rural intersections. For this reason, the proposed signal operation for each intersection of a planned highway or street improvement should be integrated into the design process in order to achieve optimum operational efficiency. Give careful consideration during the plan development phase of a proposed highway improvement to intersection and access locations, horizontal and vertical alignment with respect to signal visibility, pedestrian requirements and signal operation, to include signal phasing and signal coordination (within signal system).

When intersections reach a certain stage of congestion or have severe operational and/or safety problems, it usually becomes necessary to provide traffic signals. The selection and use of this traffic control device should be preceded by a thorough engineering study of roadway and traffic conditions. Traffic signal warrants are discussed in the *MUTCD*.

Intersections that are near 90 degrees provide the most efficient operation by providing minimum crossing distances for vehicles and pedestrians. Also, lane arrangement is a key factor to the successful operation of signalized intersections. The need for providing separate left- and right-turn lanes, to minimize vehicular conflicts, should be evaluated concurrently with the potential for obtaining the required right of way for these lanes, particularly in built-up urban areas.

The *MUTCD* and the *Highway Capacity Manual* provide detailed guidance regarding traffic control signals. There are also a number of computerized programs that address traffic signalization.

The Traffic Engineering Division and the District Traffic Engineers provide the Department's primary expertise regarding the need, installation and maintenance of traffic control signals and traffic control systems. For guidance on traffic signal designs, contact the Traffic Engineering Division.

15.2.10 Intersection Sight Distance

The designer needs to consider the effect the intersection profile and alignment will have on intersection sight distance. Landings with steep upgrades may place the driver's eye below or in line with roadway appurtenances (e.g., guardrail, signs, traffic control box, signal poles). Also, large skewed intersections will require the drivers to look back over their shoulder. The ISD triangular area does not include additional right of way that may be needed for placement of traffic control devices. For more information on intersection sight distance see [Section 10.4](#).

15.3 TURNING RADII

15.3.1 Types of Corner Radii

At intersections, the designer must determine how best to accommodate right-turning vehicles. A design must be selected for the edge of pavement or curb lines, which may be one of the following types:

- simple radius,
- compound curve (2 or 3 centered), or
- simple radius with entering and/or exiting taper(s).

Each basic design type has its advantages and disadvantages. The simple radius is the easiest to design and construct and, therefore, it is the most common. However, the designer should also consider the benefits of compound radii or a simple radius with tapers. Their advantages as compared to simple radius designs include:

1. To accommodate a specific vehicle with no encroachment, a simple radius requires greater intersection pavement area than compound curves or a radius with tapers. For large vehicles, a simple radius is often an unreasonable design, unless a channelized island is used.
2. A simple radius results in greater distances for pedestrians to cross than compound curves or a radius with tapers.
3. For angles of turn greater than 90 degrees, compound curves or a radius with tapers is a better design than a simple radius, primarily because less intersection area is required.

15.3.2 Right-Turn Designs

15.3.2.1 Design Considerations

The following presents several basic parameters the designer needs to consider in determining the proper pavement edge/curb line for turns at intersections:

1. Design Vehicle. In general, select the design vehicle based on the largest vehicle that will use the intersection with some frequency. [Section 15.2.5](#) lists the various design vehicles used by the Department. [Figure 15.2D](#) presents the suggested design vehicle based on the functional classification of the intersecting highways that the vehicle is turning from and onto.
2. Inside Clearance. The selected design vehicle will make the right turn while maintaining a minimum 2-foot clearance from the traveled way, curb line or median.

3. Encroachment. Desirably, do not allow encroachments by the design vehicle into opposing or adjacent lanes while making the right turn. However, this is not always practical and/or cost effective. The designer must evaluate possible encroachments against the construction and right of way impacts. If these impacts are significant and if through and/or turning volumes are relatively low, the designer may consider accepting some encroachment of the design vehicles into opposing lanes and, in particular, onto local streets. If there are two or more lanes of traffic in the same direction on the road onto which the turn is made, the selected design vehicle can occupy both travel lanes.
4. Parking Lanes/Shoulders. At many intersections, parking lanes and/or shoulders will be available on one or both approach legs. This additional width will greatly ease the turning problems for large vehicles at intersections with small curb radii. [Figure 15.3A](#) illustrates the turning paths of several design vehicles with curb radii of 15 and 25 feet. Restrict parking a sufficient distance from the intersection to allow the design vehicle to make the right or left turn. The designer should use the applicable turning template to determine this distance.
5. Pedestrians. The greater the turning radius, the farther pedestrians must walk across the roadway. This is especially important to disabled individuals. Larger radii also make it more difficult for drivers to see pedestrians. Therefore, the designer should consider pedestrian usage when determining the edge of pavement or curb line design. At intersections, it is important to extend the sidewalk to the beginning of the corner radius on the cross roadway to encourage safe crossings by pedestrians. This extension is shown in [Figure 15.3B](#). Note that the extension of the sidewalk in Illustration (b) in [Figure 15.3B](#) is extended beyond the radius to match the opposite corner. Discuss sidewalk termini with the Traffic Engineering Division during the Design Field Review.
6. Radii Design. Once the designer has determined the basic turning parameters (e.g., design vehicle, encroachment, inside clearance), it is necessary to select a type of turning design for the curb return or pavement edge that will meet these criteria and will fit the intersection constraints. [Section 15.3.1](#) discusses the various radii designs used by SCDOT. The selection will be determined on a case-by-case basis.
7. Turning Template. The designer should check the design with the applicable turning template or with a computer-simulated turning template program.

[Figure 15.3C](#) illustrates the many factors that should be evaluated in determining the proper design for right turns at intersections. For further information on dual turns, see [Section 15.5.4](#).

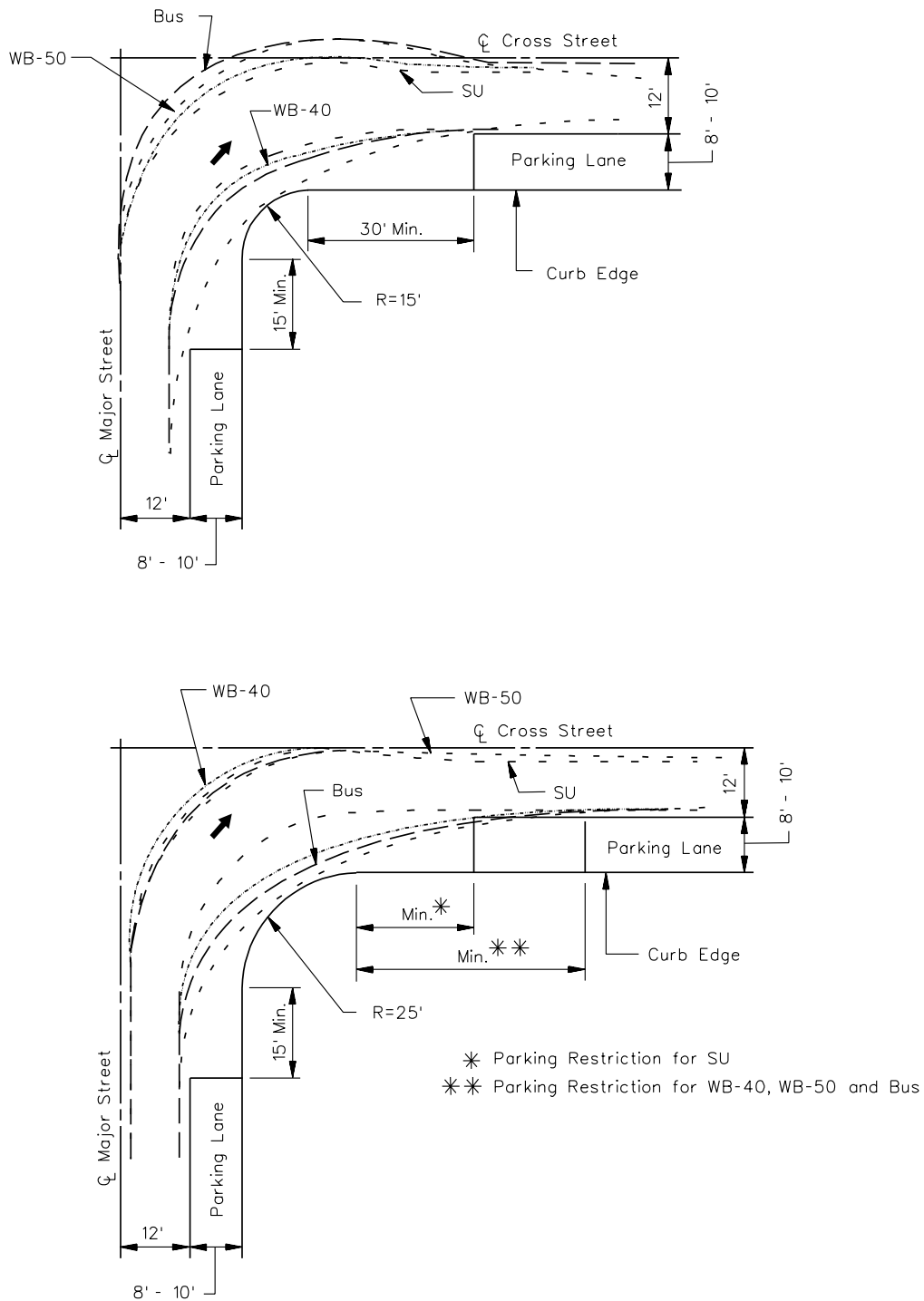

EFFECT OF CURB RADII AND PARKING ON TURNING PATHS

Figure 15.3A

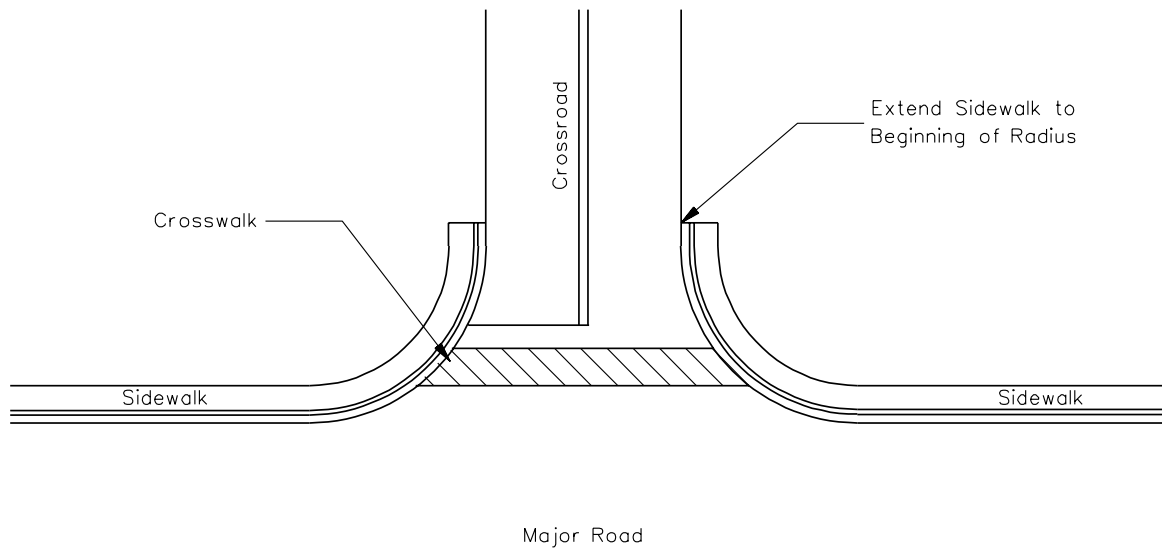

(a) PERPENDICULAR INTERSECTION

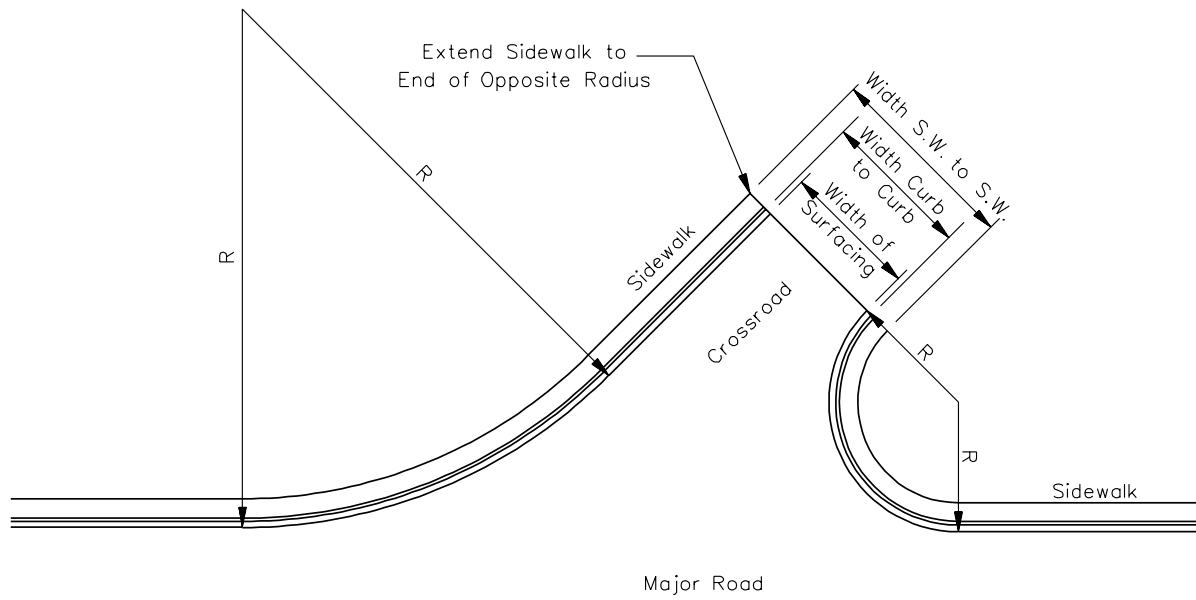

(b) ANGLED INTERSECTION

SIDEWALKS AT INTERSECTIONS

Figure 15.3B

15.3.2.2 Corner Radii Selection Guidelines

In summary, design the corner radii considering the design vehicle, right of way, angle of intersection, number of pedestrians, width and number of lanes on the intersecting streets and turning speeds. The following are additional guidelines to consider:

1. Minor Urban Intersections. Provide corner radii of 40 feet or more at minor intersections on new construction and reconstruction projects, where practical.
2. Major Urban Intersections. Provide corner radii of 40 feet or more at major cross streets so trucks may turn with minimal encroachment using turning templates to verify the adequacy of the corner radii.
3. Trucks. Where large trucks and buses are frequent turning vehicles, provide radii based on turning templates. These radii should preferably be two- or three-centered compound curves or simple curves with tapers. Typical radii and tapers are provided in the AASHTO *A Policy on the Geometric Design of Highways and Streets*.
4. Pedestrians. Coordinate radii designs with the crosswalk alignments or provide special designs for pedestrians (e.g., refuge islands, curb ramps).

15.3.3 Left-Turn Designs

Simple curves are typically used for left-turn designs. Occasionally, a two-centered curve is desirable to accommodate the off-tracking of large vehicles provided that the second curve has a larger radius.

The design values for left-turn control radii are a function of the design vehicle (off-tracking), angle of intersection, number of lanes and median width. For roadways intersecting at approximately 90 degrees, radii of 40 to 75 feet will typically satisfy all controlling factors. The criteria for clearance offsets, encroachment, etc., listed in [Section 15.3.2](#) are also applicable to left-turn designs.

For further information on dual left turns, see [Section 15.5.4](#).

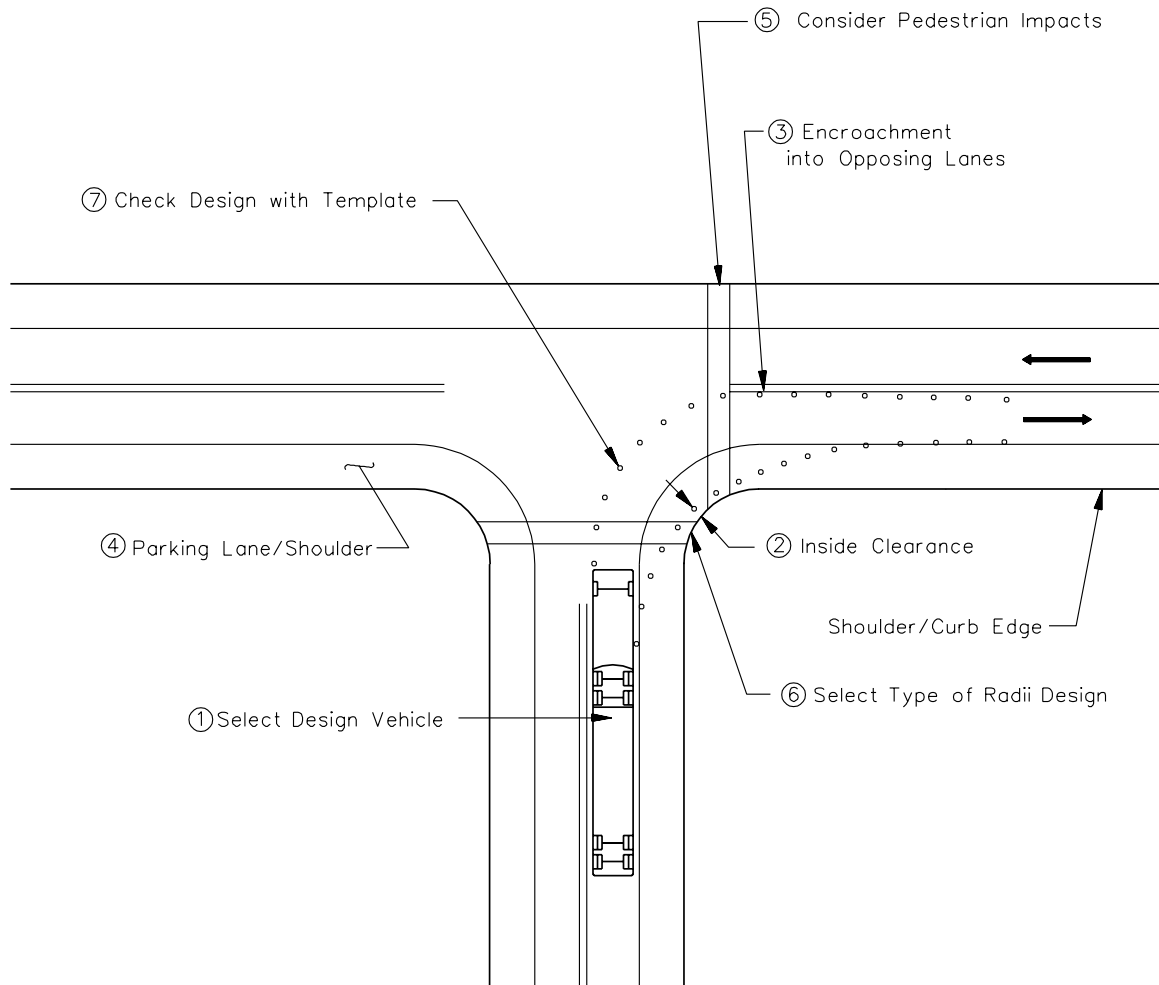

Note: Numbers apply to the Items listed in [Section 15.3.2.1](#).

TURNING RADII DESIGN SUMMARY

Figure 15.3C

15.4 TURNING ROADWAYS

Where the inner edges of pavements for right turns at intersections are designed to accommodate tractor/semi-trailer combinations or where the desired design permits passenger vehicles to turn at speeds of 10 miles per hour or greater, the pavement area at the corner of the intersection may become excessively large for proper control of traffic. To avoid this, a corner triangular island is used and the connecting roadway between the two intersection legs is defined as a turning roadway. Interchange ramps are not considered turning roadways.

15.4.1 Types of Turning Roadways

There are two types of turning roadways:

1. Turning Roadways With Corner Islands. These turning roads are commonly used at intersections where the turning radii design is excessively large such that the pavement area no longer provides the proper traffic control. A painted or raised island is provided to guide the motorist through the turning movement.
2. Free-Flow Turning Roadways. Free-flow turning roadways allow the motorist to move from one roadway to another at moderate to high speeds. Consequently, they often require superelevation, acceleration/deceleration lanes, etc. Because of the large area required for these types of roadways, the Department rarely uses these types of turning roadways. The designer is referred to the AASHTO *Policy on Geometric Design of Highways and Streets* for the necessary design details for free-flow turning roadways.

15.4.2 Guidelines

The need for a turning roadway will be determined on a case-by-case basis. The designer should consider the following guidelines in determining the need for a turning roadway:

1. Trucks. A turning roadway is usually required when the selected design vehicle is a tractor/semi-trailer combination.
2. Island Type and Size. Desirably, the island size should be at least 100 square feet. At a minimum, the island should be at least 100 square feet in rural areas and 50 square feet in urban areas.
3. Level of Service. A turning roadway can often improve the level of service (LOS) through the intersection. At signalized intersections, a turning roadway may significantly improve the capacity of the intersection by removing the right-turning vehicles from the signal timing. Level-of-service criteria are provided in the geometric design tables in [Chapters 19 through 22](#).

4. Crashes. Consider using a turning roadway with a right-turn lane if there are significant numbers of rear-end type crashes at an intersection. Turning roadways with larger radii, in conjunction with a right-turn lane, will allow vehicles to make the turning movements at higher speeds and, consequently, should reduce these types of crashes.

15.4.3 Design Criteria

Figure 15.4A illustrates a typical design for a turning roadway. Section 15.4.4 provides the criteria for turning roadway widths. Where free-flow turning roadways are provided, see the AASHTO *Policy on the Geometric Design of Highways and Streets* for design details on design speed, superelevation, horizontal alignment, acceleration/deceleration lanes, etc.

15.4.4 Width

Turning roadway widths are dependent upon the turning radii and design vehicle selected. Figure 15.2D provides the criteria for selection of the appropriate design vehicle. Figure 15.4B presents the turning roadway pavement widths for various design vehicles based on one-lane, one-way operation with no provision for passing a stalled vehicle. This design is generally appropriate for most at-grade intersections. The pavement widths in Figure 15.4B provide an extra 6 feet of clearance beyond the design vehicle's swept path. This additional width provides extra room for maneuverability, driver variances and the occasional larger vehicle.

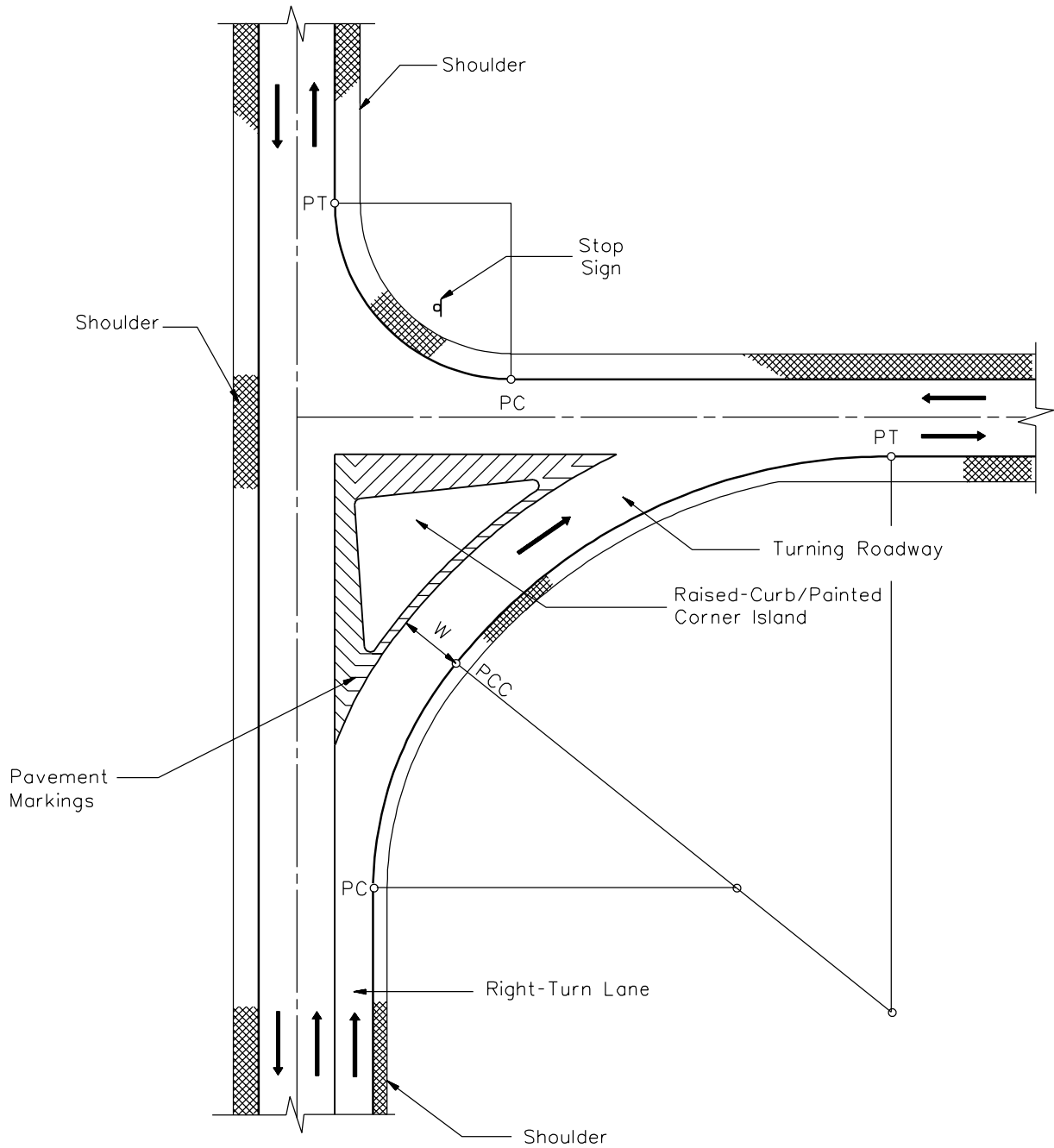

Notes:

1. *W* = Width of turning roadway; see [Figure 15.4B](#).
2. See [Figure 15.6B](#) for details of the corner island designs.

TYPICAL TURNING ROADWAY LAYOUT

Figure 15.4A

Radius on Inner Edge of Pavement R (ft)	Case 1, One-Lane, One-Way Operation, No Provision for Passing a Stalled Vehicle (ft)					
	P	P/T	S-BUS-40	SU	WB-50	WB-62
50	13	19	18	18	32	43
75	13	17	17	17	25	29
100	13	16	16	16	22	25
150	12	16	15	15	19	21
200	12	15	15	15	18	20
300	12	15	15	15	17	18
400	12	15	15	15	17	18
500	12	15	15	15	17	18
Tangent	12	14	14	14	15	15

Notes:

1. *If vertical curb is used on one side, then add 1 foot for the curb offset to the table value.*
2. *If vertical curb is used on both sides, then add 2 feet (1 foot on each side) for the curb offset to the table value.*
3. *Only use the turning roadway widths in this figure as a guide, and check the final design with the applicable turning template or computer-simulated turning template program.*

PAVEMENT WIDTHS FOR TURNING ROADWAYS

Figure 15.4B

15.5 AUXILIARY TURN LANES

15.5.1 Turn Lane Guidelines

15.5.1.1 Guidelines for Right-Turn Lanes

The use of right-turn lanes at intersections can significantly improve operations. Consider exclusive right-turn lanes:

- at the free-flowing leg of any unsignalized intersection on a two-lane urban or rural highway which satisfies the criteria in [Figure 15.5A](#);
- at the free-flowing leg of any unsignalized intersection on a high-speed, four-lane urban or rural highway which satisfies the criteria in [Figure 15.5B](#);
- at any intersection where a capacity analysis determines a right-turn lane is necessary to meet the level-of-service criteria;
- as a general rule, at any signalized intersection where the projected right-turning volume is greater than 300 vehicles per hour and where there is greater than 300 vehicles per hour per lane on the mainline;
- for uniformity of intersection design along the highway if other intersections have right-turn lanes;
- at railroad crossings where the railroad is parallel to the facility and is located close to the intersection and where a right-turn lane would be desirable to store queued vehicles avoiding interference with the movement of through traffic; or
- at any intersection where the crash experience, existing traffic operations, sight distance restrictions (e.g., intersection beyond a crest vertical curve), or engineering judgment indicates a significant conflict related to right-turning vehicles.

15.5.1.2 Guidelines for Left-Turn Lanes

The accommodation of left turns is often the critical factor in proper intersection design. Left-turn lanes can significantly improve both the level of service and intersection safety. Always use an exclusive left-turn lane at all intersections with public roads on divided urban and rural highways with a median wide enough to accommodate a left-turn lane, regardless of traffic volumes. Consider using an exclusive left-turn lane for the following:

-
- at any unsignalized intersection on a two-lane urban or rural highway which satisfies the criteria in [Figures 15.5C, 15.5D, 15.5E, 15.5F or 15.5G](#);
 - at any signalized intersection. At locations where you have 300 vehicles per hour, consider a traffic review to determine if dual left-turn lanes are required;
 - at all entrances to major residential, commercial and industrial developments;
 - at all median crossovers;
 - for uniformity of intersection design along the highway if other intersections have left-turn lanes (i.e., to satisfy driver expectancy); or
 - at any intersection where the crash experience, traffic operations, sight distance restrictions (e.g., intersection beyond a crest vertical curve), or engineering judgment indicates a significant conflict related to left-turning vehicles.

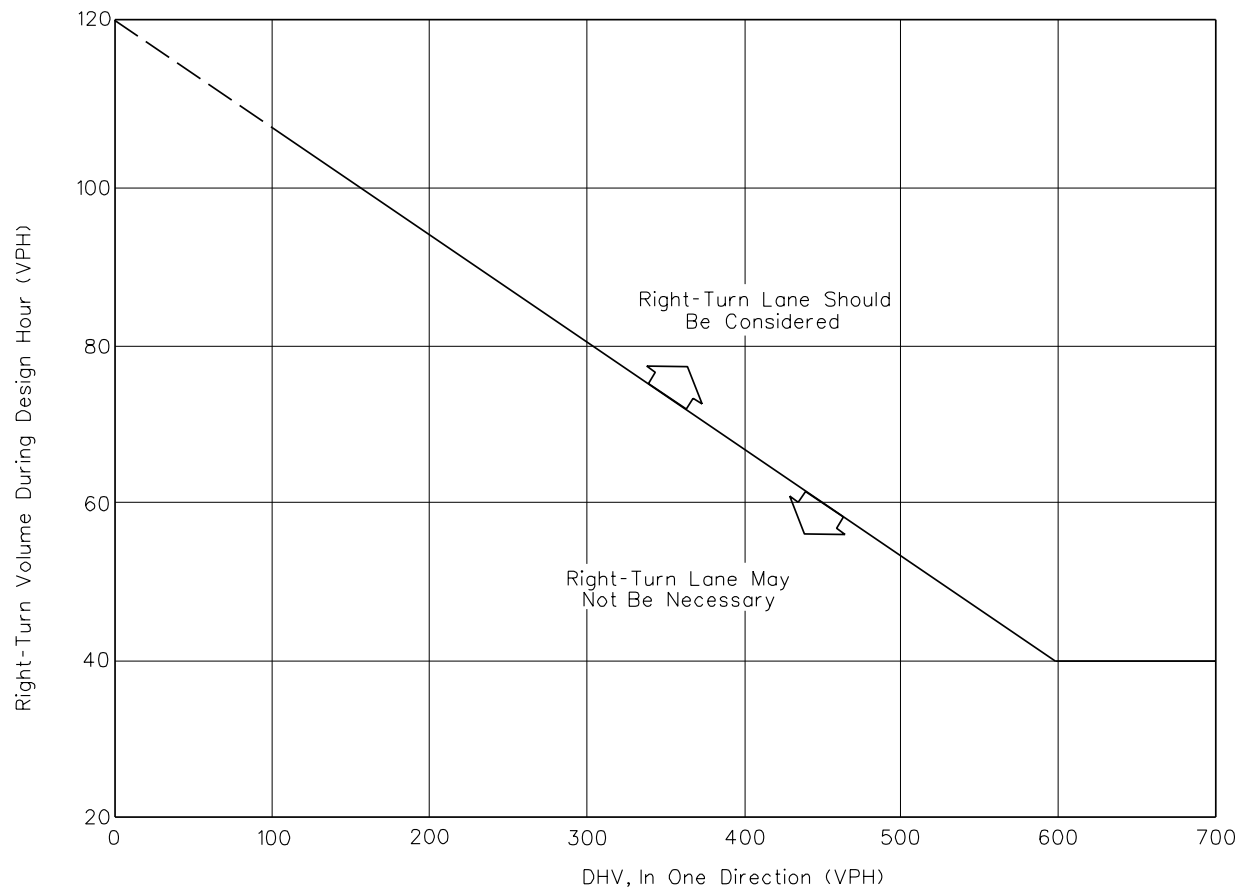

Note: For highways with a design speed below 50 miles per hour with a DHV < 300 and where right turns > 40, an adjustment should be used. To read the vertical axis of the chart, subtract 20 from the actual number of right turns.

Example

Given: Design Speed = 35 miles per hour (mph)
 DHV = 250 vehicles per hour (vph)
 Right Turns = 100 vehicles per hour (vph)

Problem: Determine if a right-turn lane is necessary.

Solution: To read the vertical axis, use $100 - 20 = 80$ vehicles per hour. The figure indicates that a right-turn lane is not necessary, unless other factors (e.g., high crash rate) indicate a lane is needed.

GUIDELINES FOR RIGHT-TURN LANES AT UNSIGNALIZED INTERSECTIONS ON TWO-LANE HIGHWAYS

Figure 15.5A

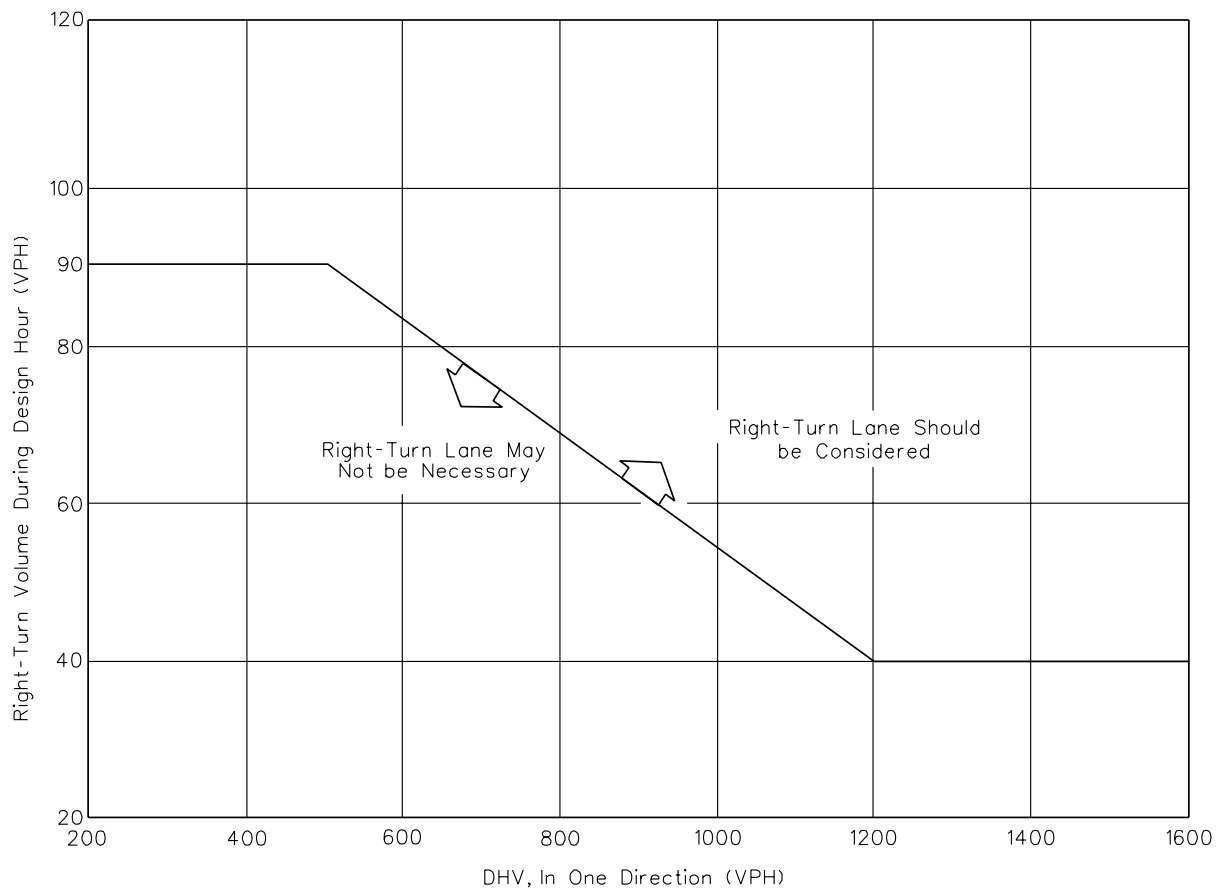

Note: Figure is only applicable on highways with a design speed of 50 miles per hour or greater.

**GUIDELINES FOR RIGHT-TURN LANES AT UNSIGNALIZED INTERSECTIONS
ON FOUR-LANE HIGHWAYS**

Figure 15.5B

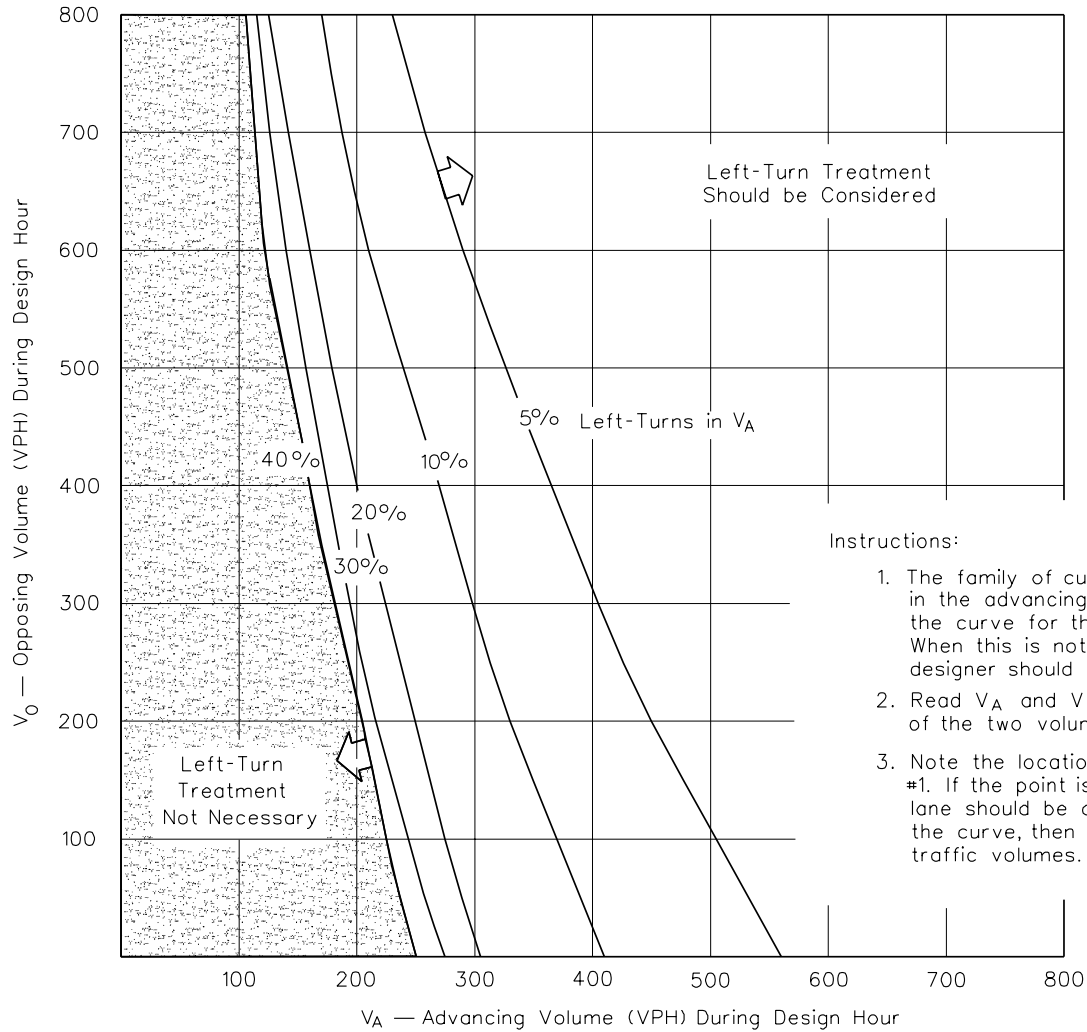

V_A = Total advancing traffic volume which includes all turning traffic

V_0 = Total opposing traffic volume which includes all turning traffic

Instructions:

1. The family of curves represent the percent of left turns in the advancing volume (V_A). The designer should locate the curve for the actual percentage of left turns. When this is not an even increment of five, the designer should estimate where the curve lies.
2. Read V_A and V_0 into the chart and locate the intersection of the two volumes.
3. Note the location of the point in #2 relative to the curve in #1. If the point is to the right of the curve, then a left-turn lane should be considered. If the point is to the left of the curve, then a left-turn lane is not warranted based on traffic volumes.

VOLUME GUIDELINES FOR LEFT-TURN LANES AT UNSIGNALIZED INTERSECTIONS ON TWO-LANE HIGHWAYS (60 MPH)

Figure 15.5C

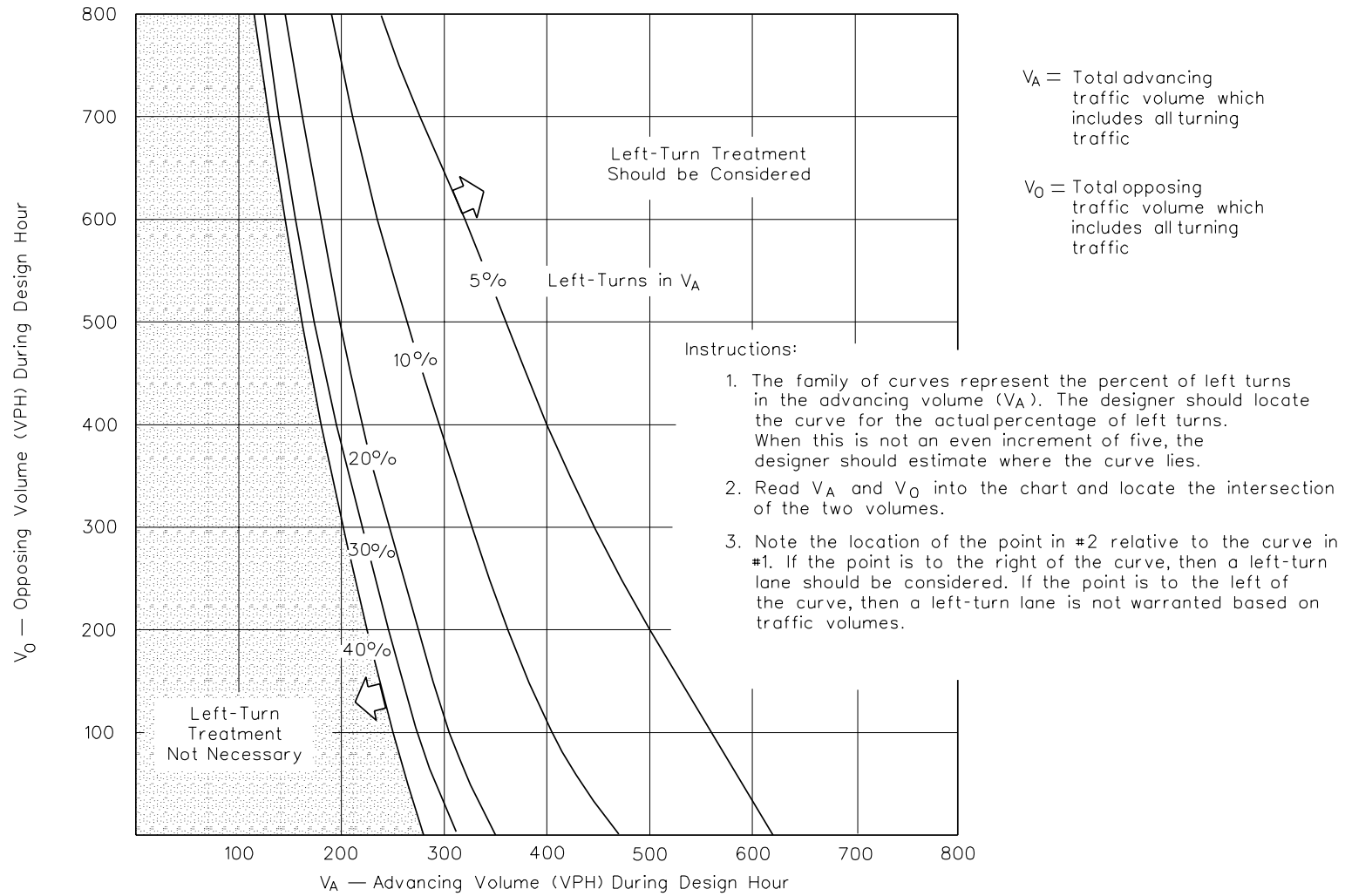

VOLUME GUIDELINES FOR LEFT-TURN LANES AT UNSIGNALIZED INTERSECTIONS ON TWO-LANE HIGHWAYS (55 MPH)

Figure 15.5D

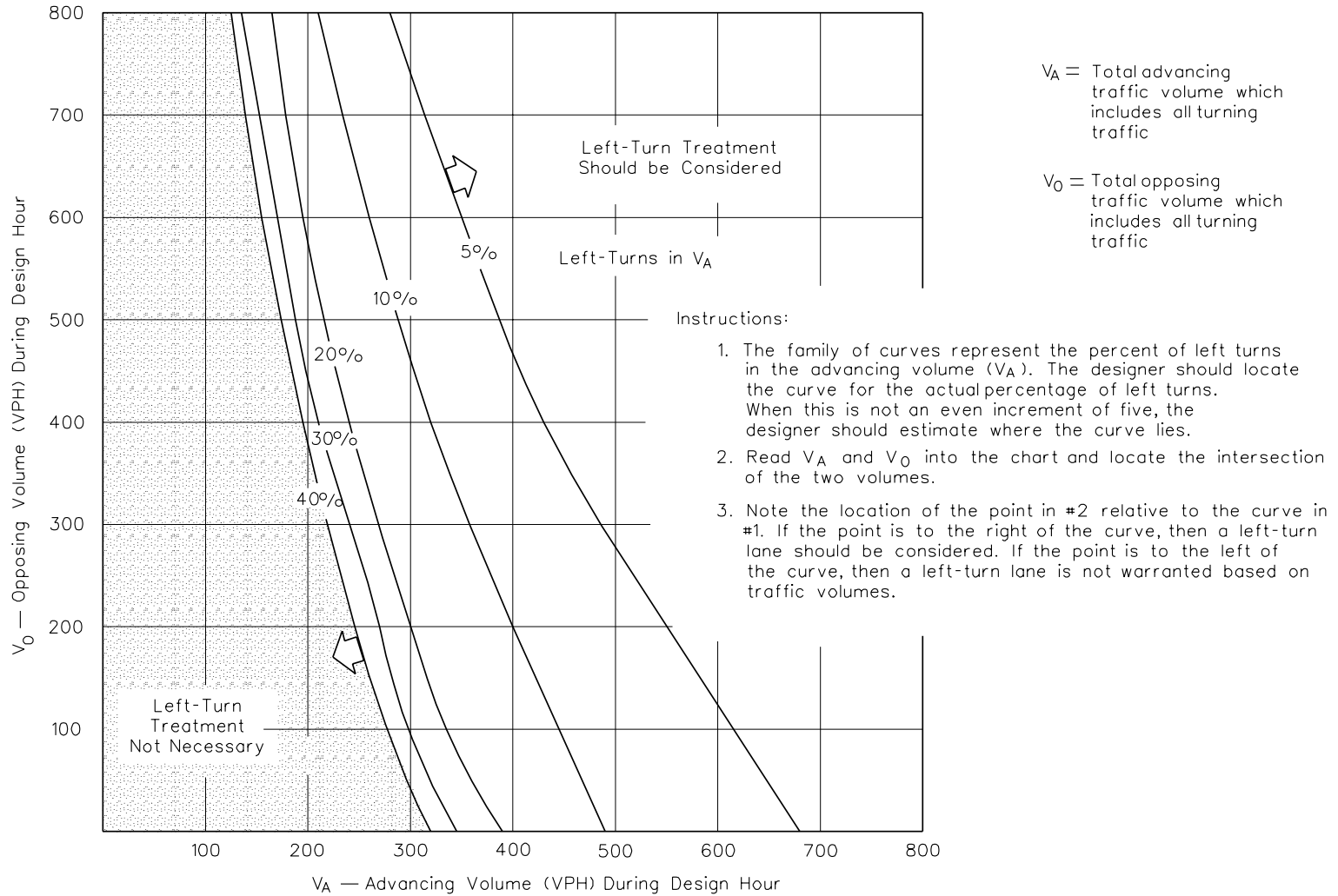

VOLUME GUIDELINES FOR LEFT-TURN LANES AT UNSIGNALIZED INTERSECTIONS ON TWO-LANE HIGHWAYS (50 MPH)

Figure 15.5E

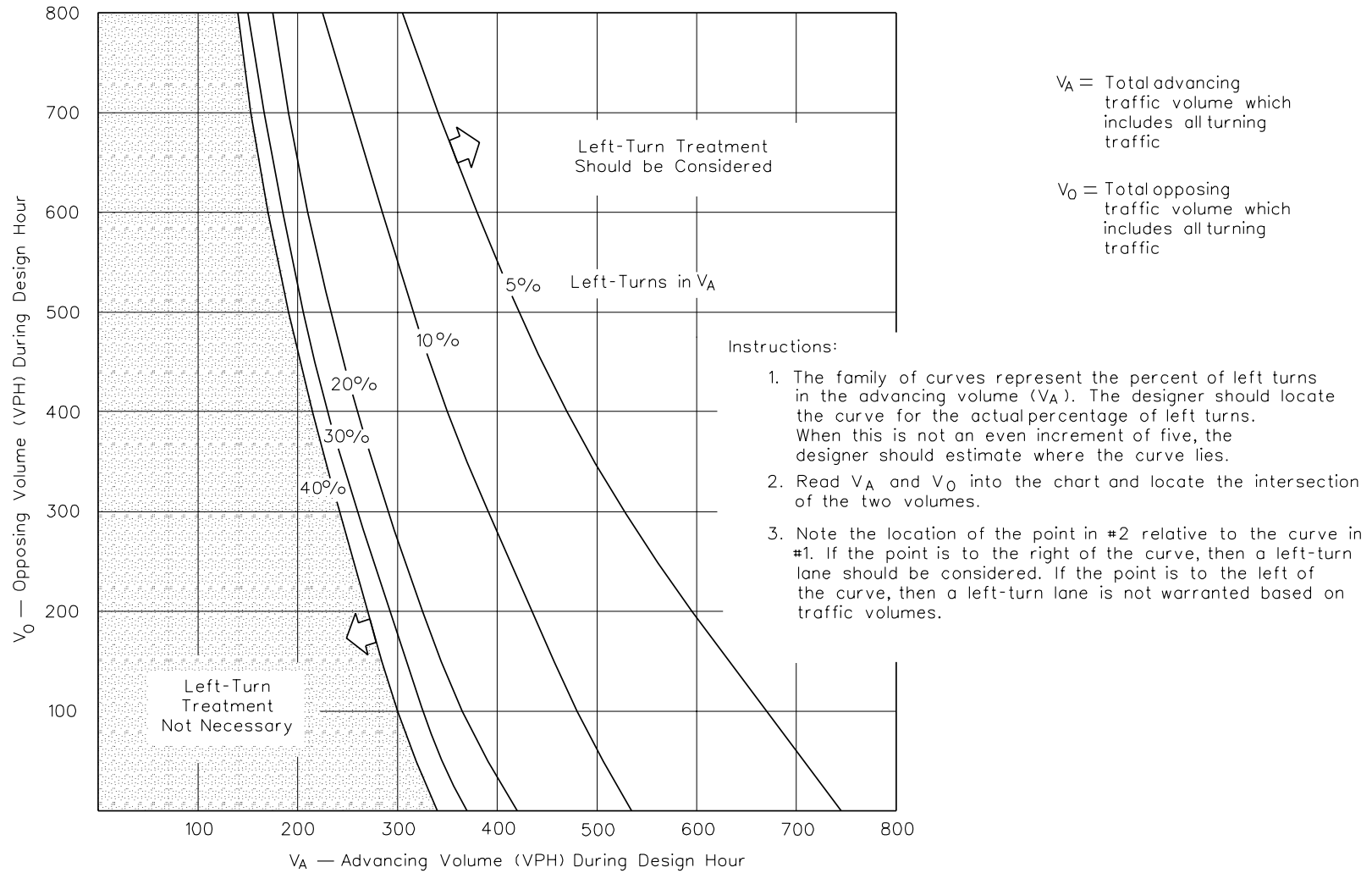

VOLUME GUIDELINES FOR LEFT-TURN LANES AT UNSIGNALIZED INTERSECTIONS ON TWO-LANE HIGHWAYS (45 MPH)

Figure 15.5F

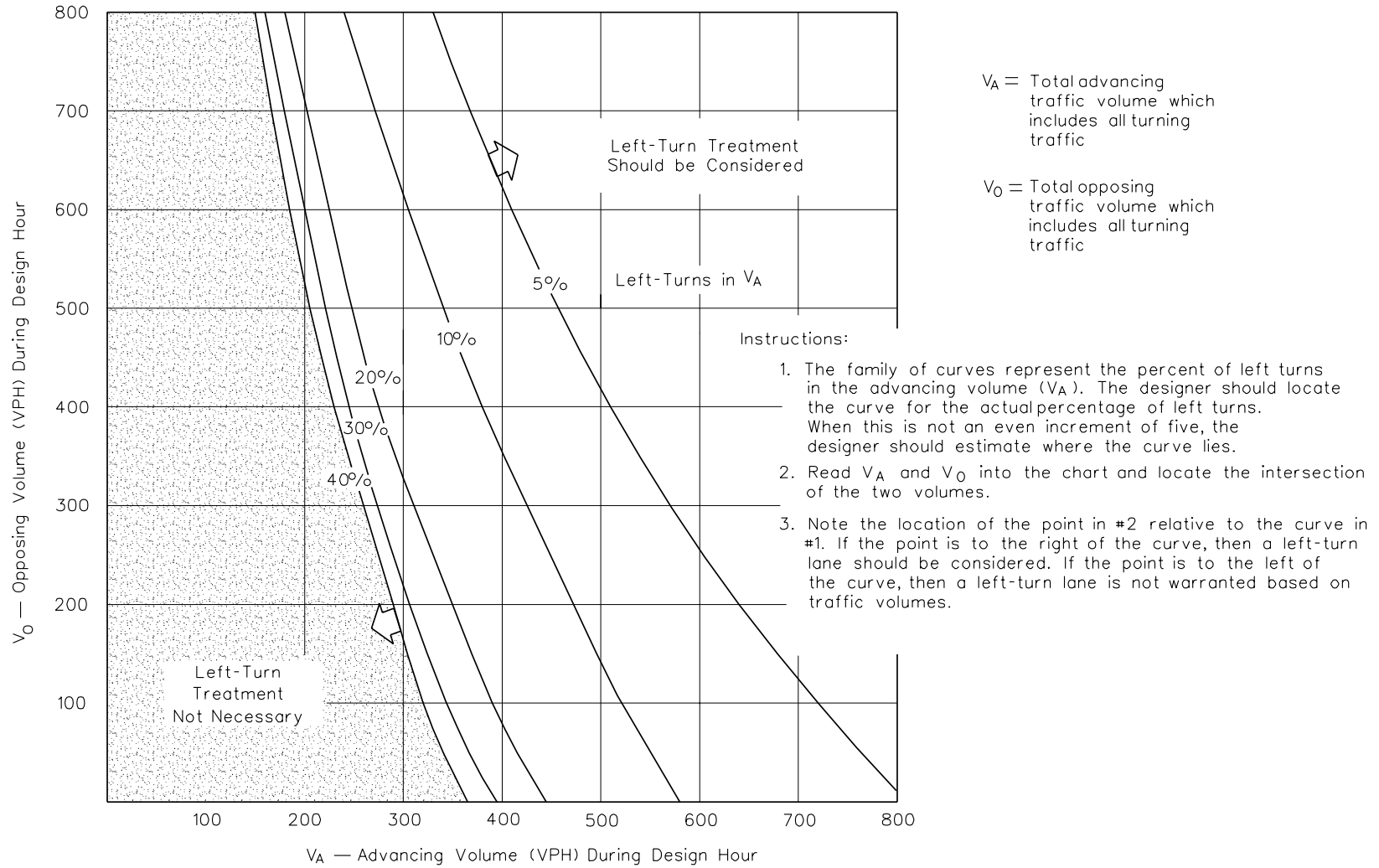

VOLUME GUIDELINES FOR LEFT-TURN LANES AT UNSIGNALIZED INTERSECTIONS ON TWO-LANE HIGHWAYS (40 MPH)

Figure 15.5G

15.5.2 Design of Turn Lanes

15.5.2.1 Widths

The following will apply to auxiliary turn lane widths:

1. Lane Widths. Typically, the width of any turn lanes at an intersection will be the same as that of the adjacent through lane. In restricted areas, it may be justified to provide a narrower width.
2. Shoulder. The designer should meet the following for shoulders adjacent to auxiliary lanes:
 - a. On Facilities without Curbs. The shoulder width adjacent to the auxiliary lane should be the same as the normal shoulder width for the roadway. At a minimum, the width may be 6 feet, assuming the roadway has a shoulder width equal to or greater than 6 feet.
 - b. On Facilities with Curbs. The offset between the auxiliary lane and face of curb should be the same as that for the normal roadway section, typically the gutter width.
3. Cross Slope. The cross slope for an auxiliary lane will depend on the number of lanes and cross slope of the adjacent traveled way. See Section 13.2.5 for information on auxiliary lane cross slopes.

15.5.2.2 Turn Lane Lengths

Desirably, the length of a right- or left-turn lane at an intersection should allow for both safe vehicular deceleration and storage of turning vehicles outside of the through lanes. The length of auxiliary lanes will be determined by a combination of its taper length, ~~deceleration length~~ and storage length. The following will apply:

1. Tapers. The entrance taper into the turn lane may be either a straight or a reverse curve taper. Typically, SCDOT uses reverse curves where the turn lane taper is painted. For other situations, straight tapers are commonly used (e.g., curb and gutter tapers). Figure 15.5H provides the recommended taper distances for straight- and reverse-curve tapers. Where the highway is on a curved alignment, the taper of the turn lane should be more pronounced than usual to insure that the through motorists are not inadvertently directed into the turn lane. This is accomplished by shortening the taper length.
2. Right-Turn Lanes. Figure 15.5I provides the minimum lengths for right-turn lanes.
3. Left-Turn Lanes. Figure 15.5J provides the minimum lengths for left-turn lanes.

Revised section 15.5.2.2 to remove “deceleration length” as a component of turn lane lengths.

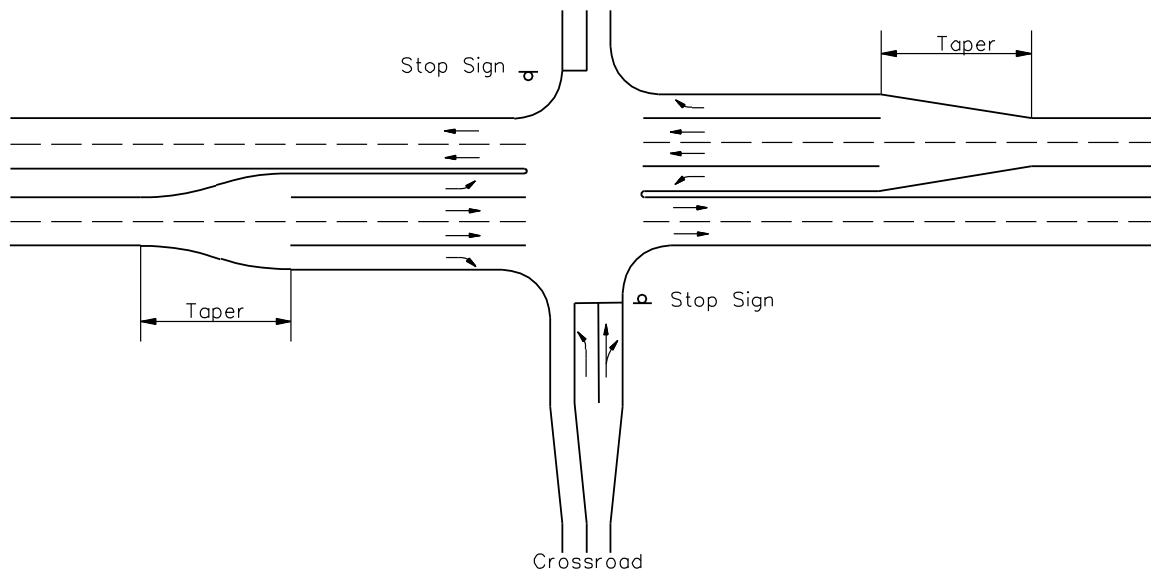

Reverse Curve Taper					Straight Taper			
Design Speed (mph)	Radius (ft)	Auxiliary Lane Widths (ft)			Design Speed (mph)	Auxiliary Lane Widths (ft)		
		W=10 ft	W=11 ft	W=12 ft		W=10 ft	W=11 ft	W=12 ft
V ≤ 30	300	109	115	120	V ≤ 30	110	115	120
31 - 40	480	138	145	152	31 - 40	140	145	150
41 - 50	670	163	171	179	41 - 50	160	170	180
V ≥ 51	840	183	192	201	V ≥ 51	200	200	200

Notes:

1. Create taper equivalent reverse curves.
2. Taper distance is approximately based on tangent alignment.
3. Based on the following formula:

$$L = \sqrt{W(4R - W)}$$

Where:

- L = Length of reverse curve taper, feet
- W = Width of auxiliary lane, feet
- R = Radius, feet

Notes:

1. W = width of turning lane.
2. Where through road is on a curve, develop a uniform offset taper from the curved mainline.

TYPICAL AUXILIARY LANES TAPER LENGTHS

Figure 15.5H

Turning Volume (vph)	Percent of Trucks in Turning Volume				
	0 to 10%	20%	40%	60%	100%
50	Use Minimum Length of 100 ft				
100					
150	150 ft	175 ft	225 ft	225 ft	250 ft
200	200 ft	225 ft	275 ft	275 ft	325 ft
250	250 ft	275 ft	325 ft	350 ft	400 ft
300	300 ft	325 ft	375 ft	425 ft	475 ft
350	350 ft	375 ft	425 ft	500 ft	550 ft

Note: The Traffic Engineering Division should review the design to determine if longer turn lane lengths are required.

GUIDELINES FOR RIGHT-TURN LANE LENGTHS

Figure 15.5I

Turning Volume (vph)	Percent of Trucks in Turning Volume				
	0 to 10%	20%	40%	60%	100%
50	In Urban Areas, Use Minimum Length of 150 ft In Rural Areas, Use Minimum Length of 200 ft				
100					
150	175 ft	225 ft	225 ft	250 ft	250 ft
200	200 ft	225 ft	275 ft	275 ft	325 ft
250	250 ft	275 ft	325 ft	350 ft	400 ft
300	300 ft	325 ft	375 ft	425 ft	475 ft
350	350 ft	375 ft	425 ft	500 ft	550 ft

Notes:

- 1. Consider providing dual-turn lanes if the turning volumes are greater than 300 vehicles per hour.*
- 2. The Traffic Engineering Division should review the design to determine if longer turn lane lengths are required.*

GUIDELINES FOR LEFT-TURN LANE LENGTHS

Figure 15.5J

15.5.3 Typical Turn Lane Treatments

Various turn lane designs are illustrated in [Figures 15.5K](#) through [15.5M](#). In addition, the designer should consider the following:

1. Two-Lane Facilities. If a left-turn lane is required on a two-lane highway, it should desirably be designed as a fully channelized left-turn lane. A typical channelized left-turn lane is illustrated in [Figure 15.5K](#). Generally, left-turn deceleration and storage bays will be designed symmetrically about the highway centerline.
2. Divided Facilities. [Figure 15.5L](#) illustrates typical treatments for left- and right-turn lanes on divided facilities. Left-turn lanes will generally be the parallel design. To properly develop the left-turn lane, the median should be at least 15 feet wide, 11 feet for the turn lane and 4 feet for the median.
3. Offset Left-Turn Lanes. On medians wider than 17 feet, it is desirable to align the left-turn lane so that it will reduce the width of the median nose to 1 to 6 feet. This alignment will place the vehicle waiting to make the turn as far to the left as practical, maximize the offset between the opposing left-turn lanes, and provide improved visibility to the opposing through traffic. The advantages of offsetting the left-turn lanes are:
 - better visibility of opposing through traffic;
 - decreased probability of a conflict between opposing left-turn movements within the intersection; and
 - more left-turn vehicles can be served in a given period of time, especially at signalized intersections.

Offset designs may be either the parallel or taper design; see [Figure 15.5M](#). The parallel design may be used at signalized and unsignalized intersections. However, the taper design is primarily only used at signalized intersections. Offset turn left-lanes should be separated from the adjacent through traveled way by painted or raised channelization.

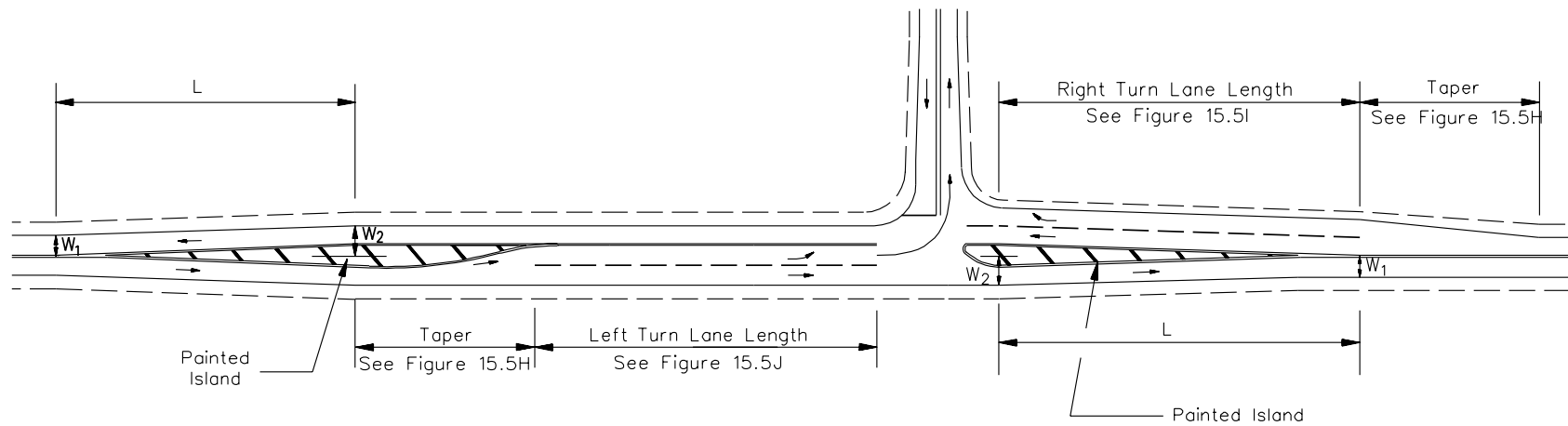

Taper Length (L) = WS ($S \geq 45$), or $L = WS^2 / 60$ ($S \leq 40$)

Where: L = *Taper Length, feet*

W = *Transition Width ($W_2 - W_1$), feet*

S = *Design Speed, miles per hour*

See [Section 15.5.2](#) for minimum turn lane lengths.

CHANNELIZED TURN LANES FOR TWO-LANE HIGHWAYS

Figure 15.5K

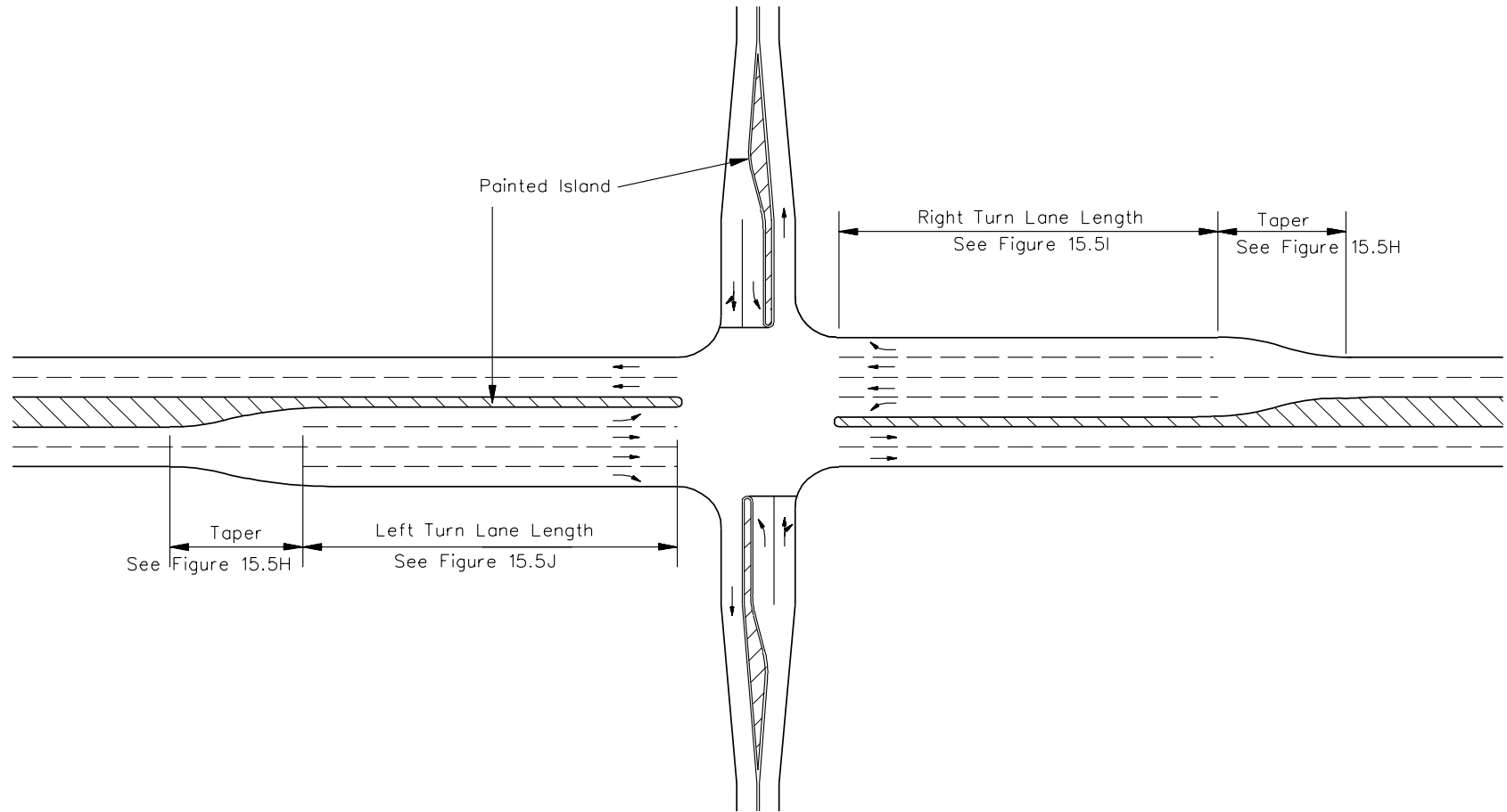

See [Section 15.5.2](#) for minimum turn lane lengths.

CHANNELIZED TURN LANES FOR FOUR-LANE HIGHWAYS

Figure 15.5L

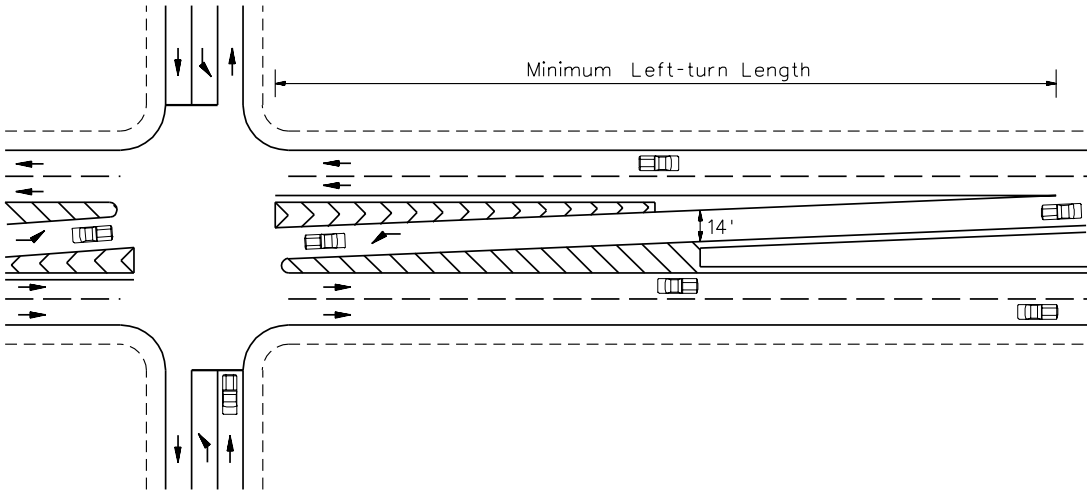

(a) TAPERED-OFFSET TURN LANE

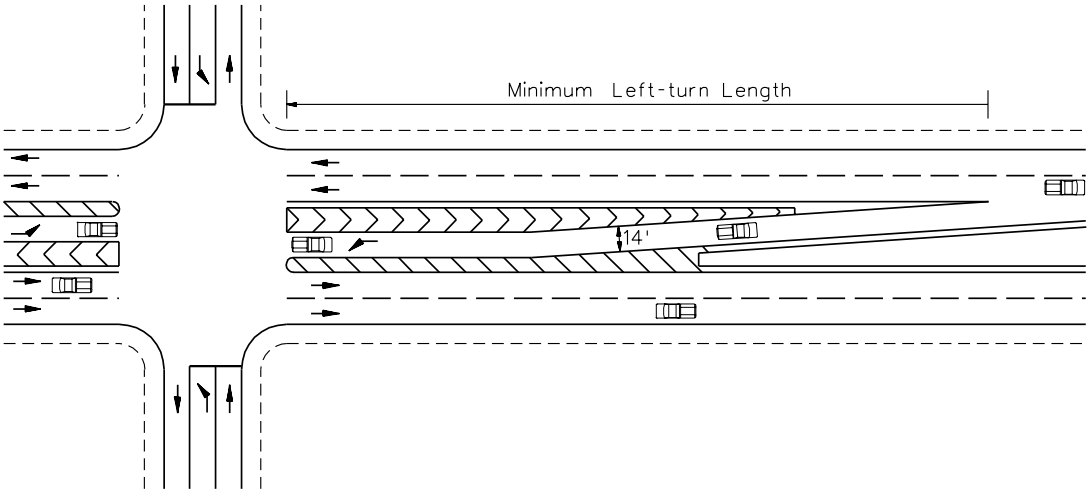

(b) PARALLEL-OFFSET TURN LANE

See [Section 15.5.2](#) for minimum turn lane lengths.

OFFSET LEFT-TURN LANES
Figure 15.5M

15.5.4 Dual-Turn Lanes

15.5.4.1 Guidelines

At signalized intersections with high-turning volumes, dual left- and/or right-turn lanes may be considered. However, multiple turn lanes may cause problems with right of way, lane alignment, crossing pedestrians and lane confusion for approaching drivers. Consider dual right- and left-turn lanes where:

- based on the capacity analysis, the necessary time for a protected left-turn phase becomes unattainable to meet the level-of-service criteria (average delay per vehicle); and/or
- there is insufficient space to provide the calculated length of a single-turn lane because of site restrictions (e.g., closely spaced intersections).

Dual right-turn lanes do not work as well as dual left-turn lanes because of the more restrictive space available for two-abreast right turns. If practical, the designer should find an alternative means to accommodate the high number of right-turning vehicles. For example, a turning roadway may accomplish this purpose.

15.5.4.2 Design

A dual-turn lane (both lanes exclusive) can potentially discharge approximately 1.9 times the number of cars that will discharge from a single exclusive turn lane. However, to work properly, several design elements must be carefully considered. [Figure 15.5N](#) presents both dual right- and left-turn lanes to illustrate the more important design elements. The designer should consider the following:

1. Turning Templates. Using the applicable turning templates, check all intersection design elements for dual-turn lanes. The designer should assume that the larger selected design vehicle would turn from the lane with the widest turn. Typically, the SU design vehicle will turn side-by-side with the selected design vehicle. See [Figure 15.5N](#) for the design vehicle placement.
2. Throat Width. Because of the off-tracking characteristics of turning vehicles, the normal width of two travel lanes may be inadequate to properly receive two vehicles turning abreast. Therefore, the receiving throat width may need to be widened. This should be checked using turning templates. For 90-degree intersections, the designer can expect that the throat width for dual-turn lanes will be approximately 30 to 36 feet. When determining the available throat width, the designer can assume that the paved shoulder, if present, will be used to accommodate two-abreast turns.

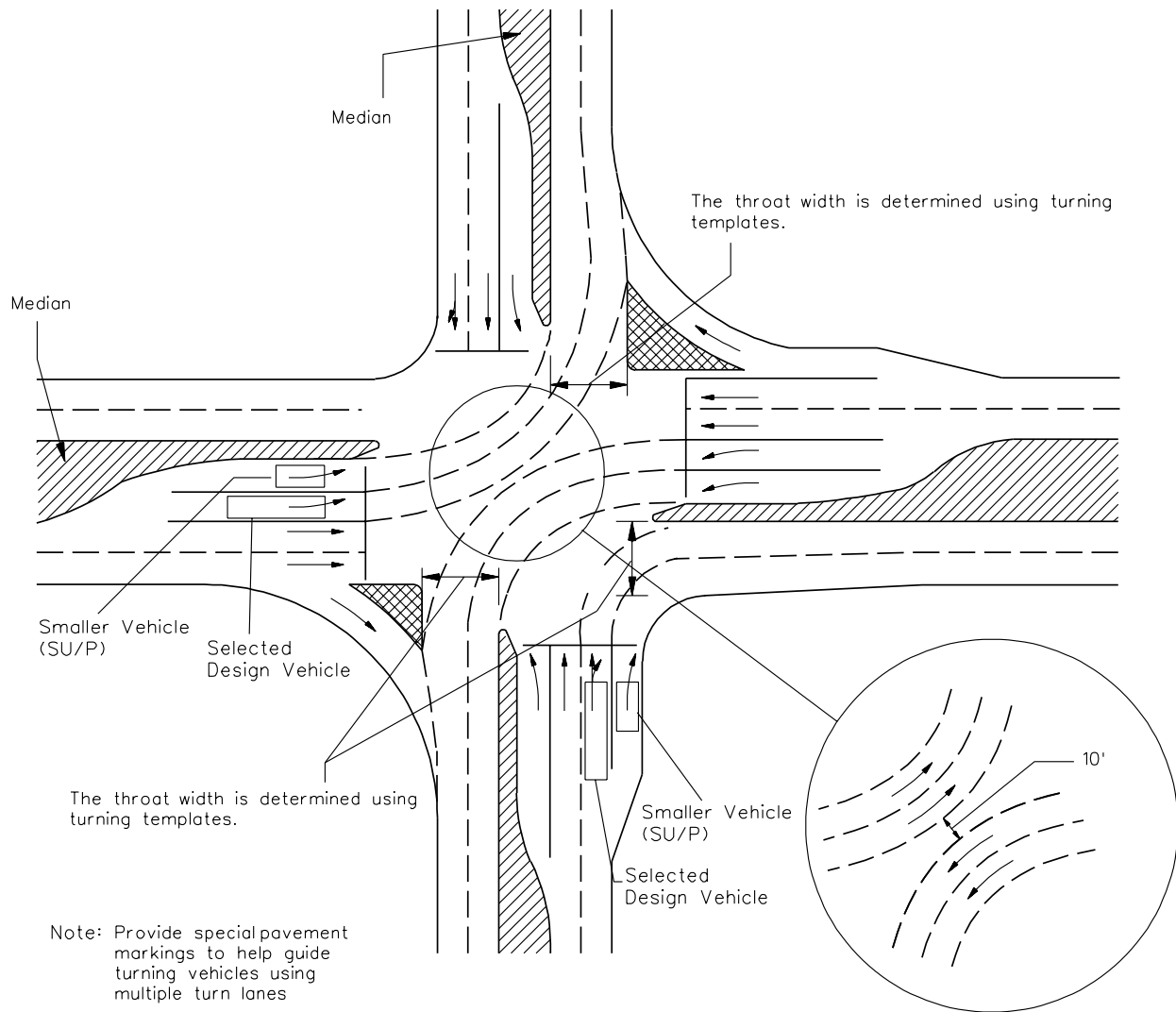

DUAL-TURN LANES
Figure 15.5N

3. Widening Approaching Through Lanes. If a 30- to 36-foot throat width is provided to receive dual-turn lanes, the designer should also consider how this would affect the traffic approaching from the other side. The designer should also insure that the through lanes line up relatively well to insure a smooth flow of traffic through the intersection.
4. Median Widths. It is desirable to have a median width of at least 28 feet for dual left-turn lanes.
5. Pavement Markings. Pavement markings can effectively guide two lanes of vehicles turning abreast. See the *MUTCD* for applicable guidelines on the selection and placement of any special pavement markings.
6. Opposing Left-Turn Traffic. It is desirable that opposing left turns occur simultaneously; therefore, the designer should insure that there is sufficient space for all turning movements. The separation between turn lanes should be 10 feet; see [Figure 15.5N](#). If space is unavailable, it will be necessary to alter the signal phasing to allow the two directions of turning traffic to move through the intersection on separate phases.
7. Length of Receiving Lanes. Dual left turn lanes require two receiving lanes. The minimum length of dual receiving lanes should be 1000 feet, excluding the lane drop taper.

15.5.5 Acceleration Lanes

On multilane facilities, acceleration lanes may be considered near industrial parks or other major traffic generators. The acceleration design lengths can be determined by reviewing the acceleration distances in [Chapter 16](#) for ramps and the AASHTO *A Policy on the Geometric Design of Highways and Streets*.

15.6 CHANNELIZATION

15.6.1 Functional Types

Islands can be grouped into the following functional classes. Most islands serve at least two of these functions:

1. Divisional Islands. Divisional islands segregate opposing traffic flows, alert the driver to the crossroad ahead and regulate traffic through the intersection. These islands are often introduced at intersections on undivided highways and are particularly advantageous in controlling left turns at skewed intersections. This prevents conflicts with stored vehicles stopped at the stop bar and improves the intersection sight triangles. [Figure 15.6A](#) illustrates an intersection with divisional islands.
2. Channelization Islands. Channelization islands control and direct traffic movements and guide the driver into the proper channel. Corner islands are one type of channelization islands. Corner islands at or near crosswalks channelize right-turning vehicles and aid or protect pedestrians crossing a wide roadway.
3. Refuge Islands. Refuge islands at or near crosswalks or bicycle paths aid or protect pedestrians and bicyclists crossing a wide roadway. These islands may be required for pedestrians at intersections where complex signal phasing is used. The island width must be sufficient to meet the anticipated storage needs (pedestrians and bicyclists) and/or disabled needs (e.g., wheelchairs) for refuge purposes.

15.6.2 Selection of Channelization

Channelization may consist of some combination of flush or raised, concrete or grass, and may be triangular or elongated. Selection of an appropriate type of channelization will be determined on a case-by-case evaluation based on traffic characteristics, cost considerations and maintenance needs. The following Sections offer guidance for channelization.

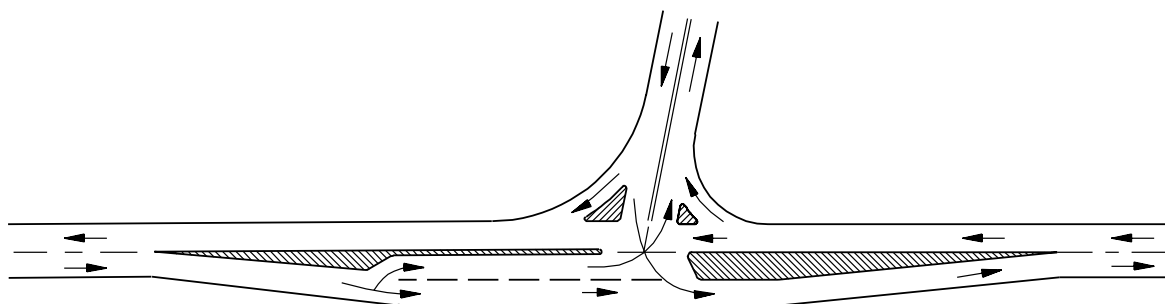

DIVISIONAL ISLANDS

Figure 15.6A

15.6.2.1 Flush Channelization

Flush channelization is appropriate:

- at locations requiring delineation of vehicular paths, such as at major route turns or intersections with unusual geometry;
- on high-speed rural highways to delineate separate turning lanes;
- in restricted locations where vehicular path definition is desired, but space for larger, raised channelization is not available; and/or
- to separate opposing traffic streams on low-speed streets.

15.6.2.2 Raised Channelization

Raised channelization emphasizes the location of the movement to be completed. Raised channelization is appropriate:

- at locations requiring positive delineation of vehicular paths, such as at major route turns or intersections with unusual geometry;
- where a primary function of an island is to provide a pedestrian refuge;
- where a primary or secondary island function is the location of traffic signals, signs or other traffic control features;
- where the channelization is intended to prohibit or prevent traffic movements; and/or
- on low- to moderate-speed highways where the primary function is to separate high volumes of opposing traffic movements.

Where a raised channelization is selected, a sloping concrete curb will typically be used. In addition, the need for lighting the intersection will be determined on a case-by-case basis.

15.6.3 Size

Corner islands and divisional islands should be large enough to command the driver's attention. Shapes and sizes will vary from one intersection to another. The following will apply:

1. Corner Islands. The recommended minimum size is 50 square feet (urban) and 100 square feet (rural). Desirably, all triangular islands will be at least 100 square feet, if practical. Islands used for pedestrian refuge should be at least 150 square feet to allow for the construction of curb ramps or channels for the disabled.
2. Divisional Islands. The recommended minimum width is 4 feet and desirably 10 feet wide. Divisional islands should not be less than 20 to 25 feet long.

15.6.4 Offset to Through Lanes

In urban areas on approaching roadways with curb offsets, offset the raised channelization at least 2 feet from the travel lane ([Figure 15.6B\(a\)](#)). Where shoulders are present, offset raised channelization a distance equal to the shoulder width ([Figure 15.6B\(b\)](#)). In rural areas and where separate turning lanes are used, offset the island from the turning lane by at least 2 feet. If there are no turning lanes, the island should be offset a distance equal to the shoulder width.

15.6.5 Delineation

Pavement markings are used in advance of and around the raised channelization to warn the driver. These traffic control devices are especially important at the approach to divisional islands for the direction of approaching traffic. For guidance on pavement markings around divisional islands; see the *MUTCD*.

15.6.6 Concrete Island in Flush Median

[Figure 15.6C](#) depicts the use of concrete divisional islands at left-turn lanes at intersections. The left-turn lane storage requirements and the design vehicle-turning path will determine the length and location of the concrete divisional island.

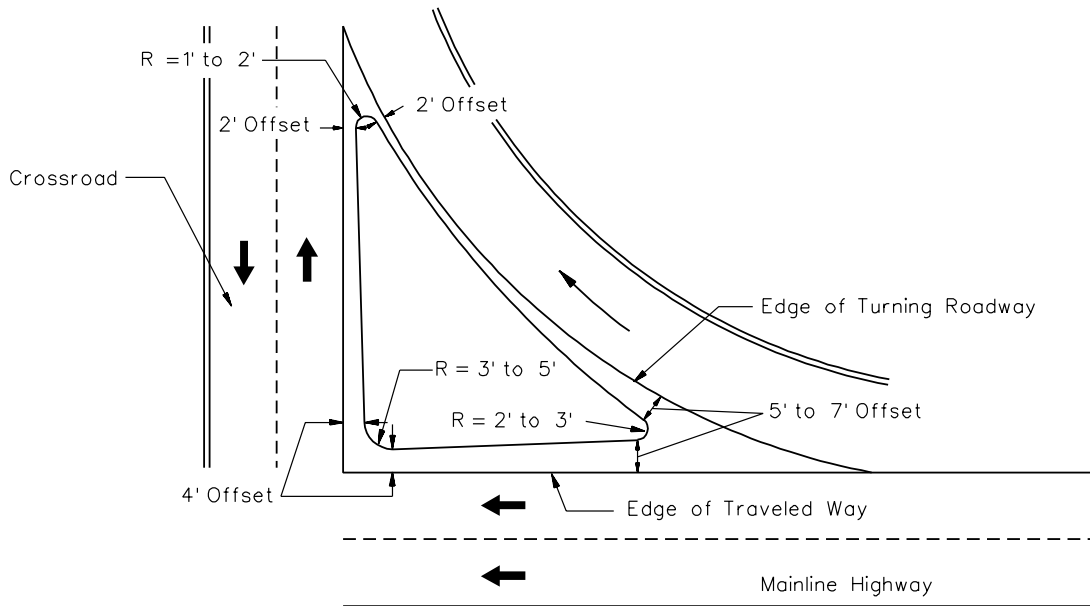

(a) Street with Curb and Gutter

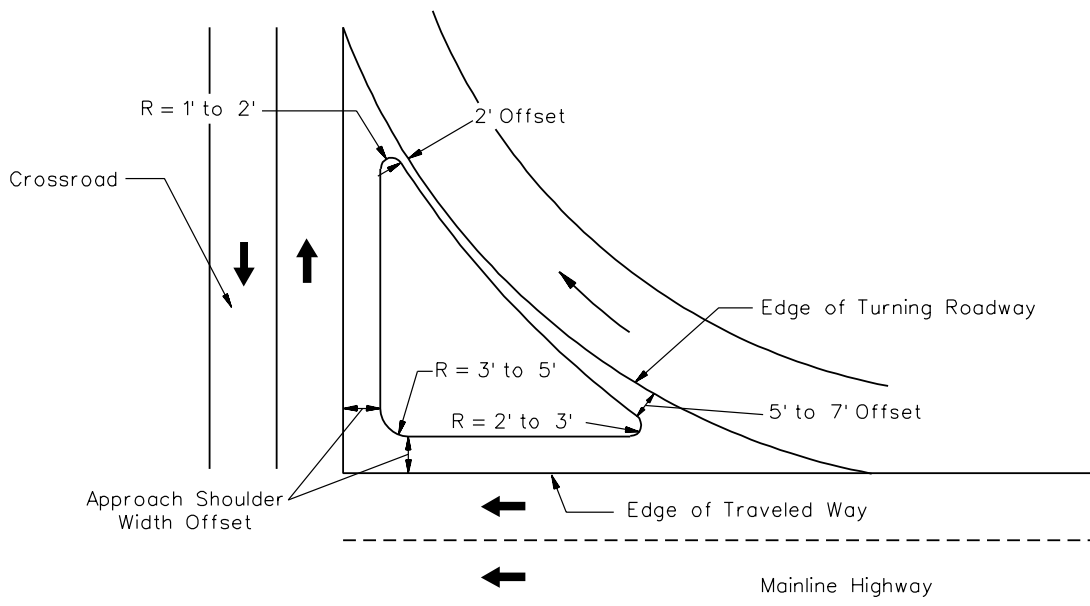

(b) Road with Shoulders

TRIANGULAR ISLANDS

Figure 15.6B

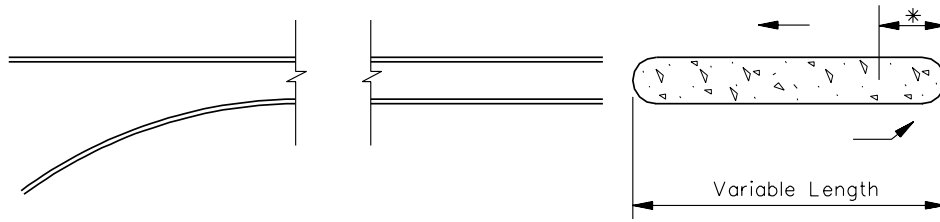

* 10' To Sign Post Location (If Required)

**CONCRETE DIVISIONAL ISLANDS
(Location with Left-Turn Lane)**

Figure 15.6C

15.7 MEDIAN OPENINGS

15.7.1 Location

Median openings are provided on all divided highways with limited control of access or uncontrolled access provided the openings are sufficiently spaced. The following recommended minimum spacings should be evaluated when determining the location for a median opening:

1. Facilities with Controlled Access. U-turn median openings may be provided on freeways having non-barrier medians and where needed for the proper operation of police and emergency vehicles. They may also be provided for equipment engaged in routine maintenance and rest area maintenance where rest areas are across the median from each other.
2. Facilities with Partial Access Control. On rural divided highways, median openings are provided at most public highways and streets (site specific). Median openings are generally provided for major traffic generators (e.g., industrial or commercial parks). Median openings for driveway access should not be spaced closer than 1500 to 2000 feet apart.
3. Facilities with Uncontrolled Access. Provide a median opening at all public highways and streets. Median openings for driveway access should not be less than 1000 to 1500 feet apart.

In addition to the above criteria, the location of median openings should be consistent with the following design considerations:

1. Signal Coordination. Median openings (both signalized and unsignalized) must not impair the traffic signal coordination of the overall facility.
2. Sight Distance. Do not locate median openings in areas of restricted sight distance (e.g., on a horizontal curve or near the apex of a crest vertical curve). [Section 10.4](#) discusses the minimum intersection sight distances that should be available at a median opening.
3. Turn Lane Length. Provide median openings only if the full length of a left-turn lane can be provided and if the beginning of the turn lane taper is at least 100 feet from the median nose of the previous intersection. See the schematic in [Figure 15.7A](#). Determine the length of the left-turn lane using the criteria in [Section 15.5.2](#).

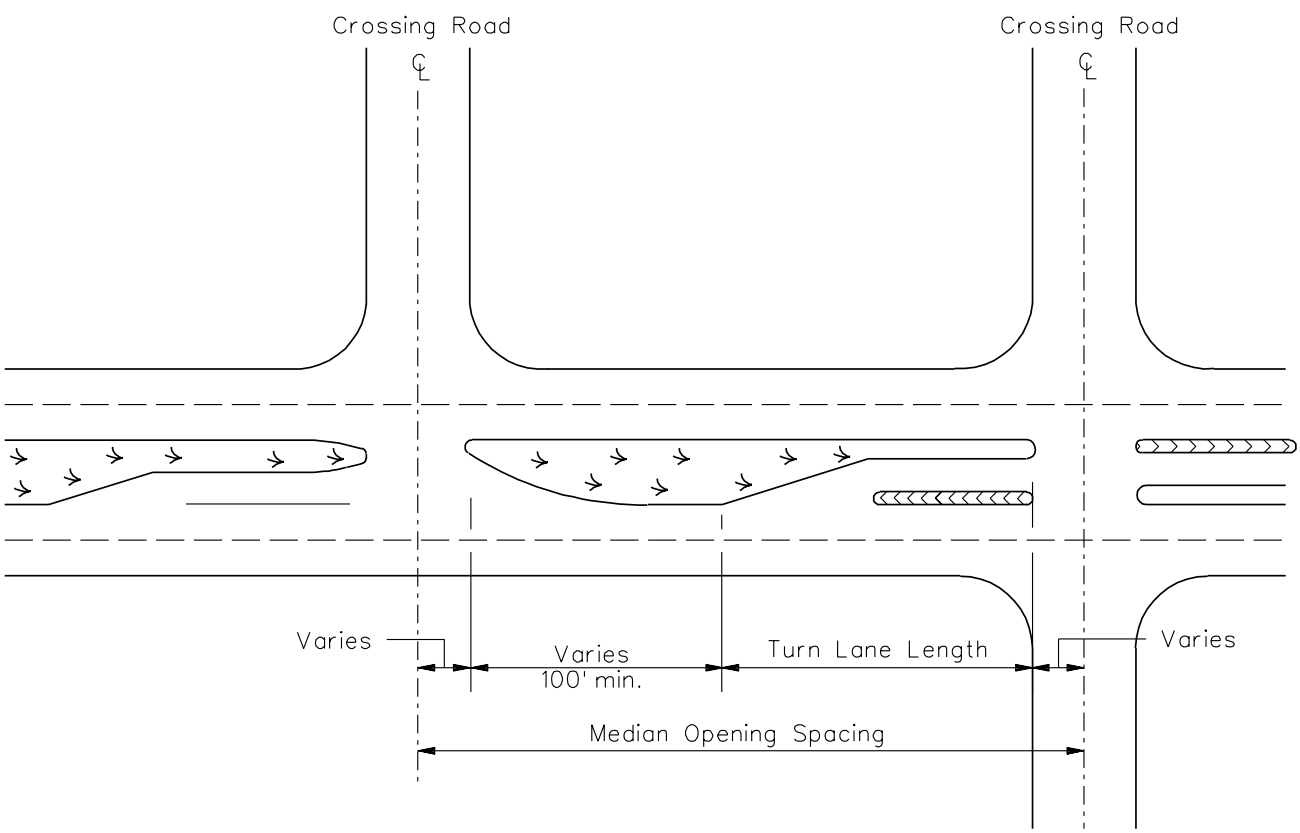

LOCATIONS OF MEDIAN OPENINGS ON NON-FREEWAYS

Figure 15.7A

15.7.2 Design

Figure 15.7B presents a general figure for the design of a median opening. The following will apply to the design of median openings:

1. Design Vehicle. The largest vehicle that will be making the turn with some frequency should be used as the design vehicle for median openings. The process for the selection of the design vehicle is the same as for a right-turning vehicle; see Section 15.2.5.
2. Encroachment. The desirable design will allow the design vehicle to make a left turn and to remain entirely within the through inside lane of the divided facility. In addition, the turning vehicle should be no closer than 2 feet to the inside curb or inside edge of traveled way. However, depending on traffic control or available intersection sight distance, it would be acceptable for the design vehicle to occupy both travel lanes (e.g., a vehicle stopped at a signalized intersection exiting from a side street may turn left on any green signal while encroaching on both travel lanes of the facility being turned onto); see Figure 15.7B.
3. Length of Opening. The length of a median opening should properly accommodate the turning path of the design vehicle. The minimum length is the largest of the following:
 - approach width plus the width of shoulders, including crossroad median width;
 - the length based on the selected design vehicle; or
 - 40 feet.

Evaluate each median opening individually to determine the proper length of opening. Consider the following factors in the evaluation:

- a. Turning Templates. Check the proposed design with the turning template for the selected design vehicle. Give consideration to the frequency of the turn and to the encroachment onto adjacent travel lanes or shoulders by the turning vehicle.
- b. Nose Offset. At four-leg intersections, traffic passing through the median opening (going straight) will pass the nose of the median end (semicircular or bullet nose). To provide a sense of comfort for these drivers, the offset between the crossroad through travel lane (extended) and the median nose should be at least 2 feet.
- c. Lane Alignment. Provide a design where the lanes line up properly across the intersection.

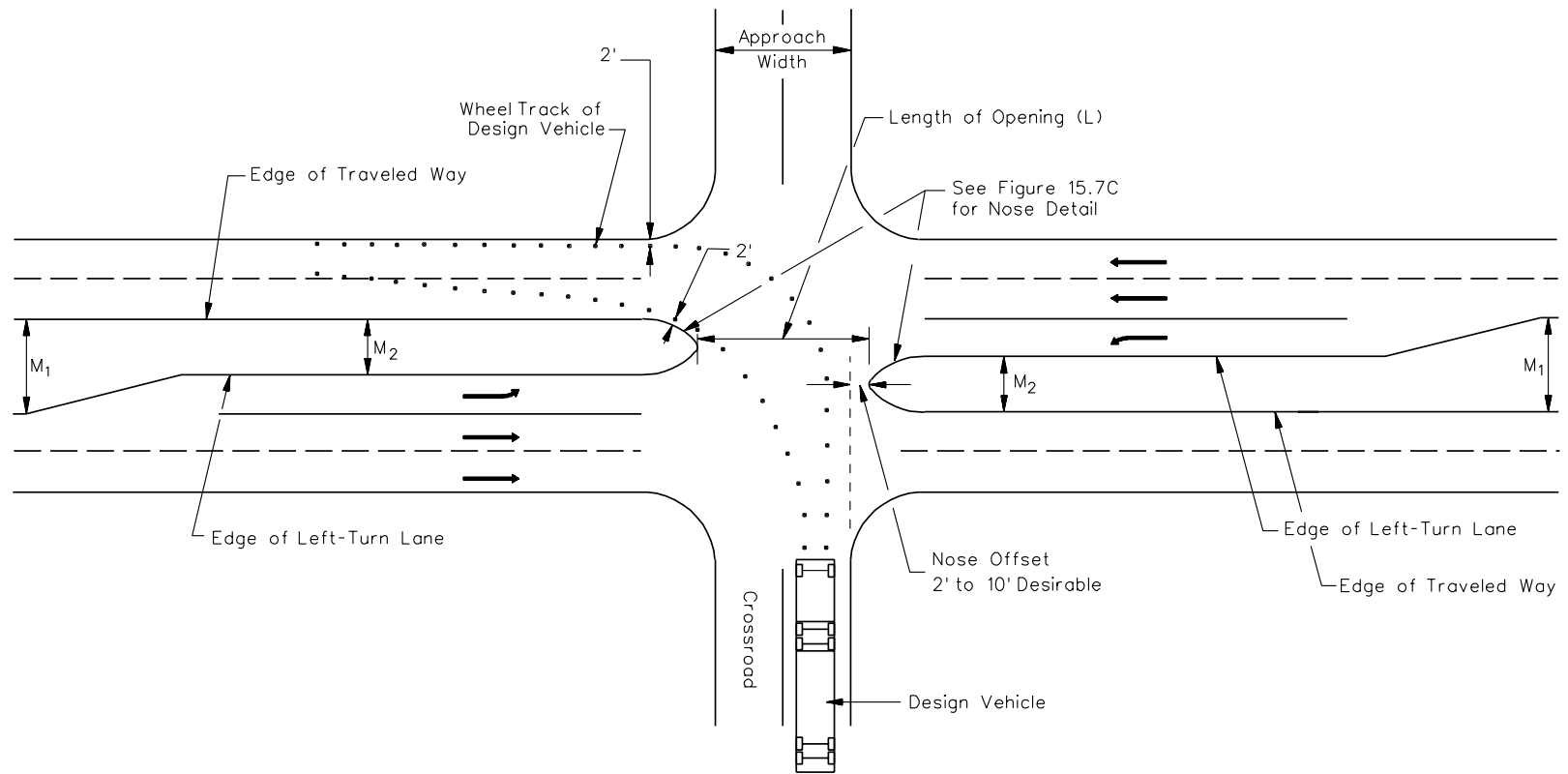

Note: See discussion in [Section 15.7.2](#) for minimum L criteria.

MEDIAN OPENING DESIGN

Figure 15.7B

- d. Location of Crosswalks. Desirably, pedestrian crosswalks will intersect the median nose to provide some refuge for pedestrians. Therefore, the median opening design should be coordinated with the location of crosswalks.
 - e. Traffic Control. See the *MUTCD* for the design of intersection signing, striping and traffic control.
4. Median Nose Design. The shape of the nose at median openings is determined by the width of the median (M_1) or (M_2). The two basic types of median nose designs are the semicircular design and bullet-nose design. The following summarizes their usage:
- For medians up to 4 feet in width, there is little operational difference between the two designs.
 - The semicircular design is generally acceptable for median widths (M_1) up to 10 feet.
 - For medians (M_1) wider than 10 feet, use the bullet-nose design. Also, use this design for the divisional island remaining after locating a left-turn lane in the median.
 - As medians become successively wider, the minimum length of the median opening becomes the governing design control.
- For the bullet-nose design, a compound curvature arrangement should be used. [Figure 15.7C](#) provides the typical details for a median opening with a bullet-nose design.
5. U-turns. Median openings are sometimes used to accommodate U-turns on divided highways. Preferably, a vehicle should be able to begin and end the U-turn on the inner lanes next to the median. [Figure 15.7D](#) provides the minimum median widths for U-turn maneuvers for various design vehicles and various levels of encroachment. Check the U-turn design with the applicable turning template.
 6. Sight Distance. All median openings should be checked for applicable sight distance criteria; see [Section 10.4](#).
 7. Wide Medians. Where the medians are wider than 75 feet, treat the design as two separate intersections.

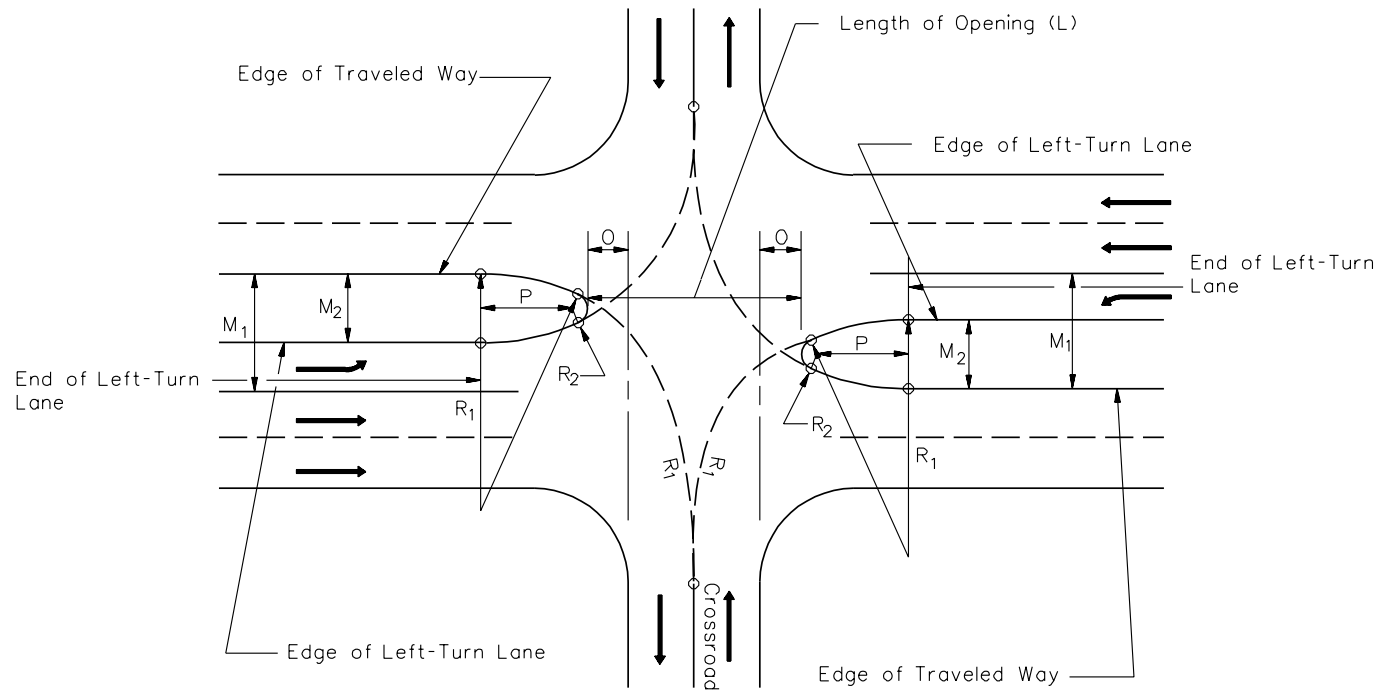

L = Length of median opening. See discussion in [Section 15.7.2](#) for minimum L values.

M_1 = Median width measured between the two edges of the inside travel lanes.

M_2 = Width of divisional island (flush, raised-curb, depressed) remaining after the width of the left-turn (if present) has been subtracted from the median width (M_1).

O = Nose offset.

P = As shown in figure.

R_1 = Variable, based on design vehicle and median width (M_2).

R_2 = $M_2/5$ to edge of left-turn lane, where present.

R_2 = $M_1/5$ to edge of traveled way where a left-turn lane is not present.

R_2 is typically rounded up to the next highest whole number.

MEDIAN NOSE DESIGN

Figure 15.7C

Type of Maneuver		M - Min. width of median for design vehicle (ft)				
		P	SU	BUS	WB-40	WB-50/ WB-62
		Length of design vehicle (ft)				
		19	30	40	50	55
Inner Lane to Inner Lane		30	63	63	61	71
Inner Lane to Outer Lane		18	51	51	49	59
Inner Lane to Shoulder		8	41	41	39	49

Note: The selected design vehicle will affect the length of the median opening.

MINIMUM WIDTHS NEEDED FOR U-TURNS

Figure 15.7D

15.8 RAILROAD/HIGHWAY GRADE CROSSINGS

Chapter 6 provides guidance on coordinating with the Railroad Company. The Utilities Office is responsible for this coordination.

15.8.1 Railroad Crossings Near Intersections

These design guidelines apply to all highway improvement projects where the route is adjacent and parallel to a railroad. Where an at-grade railroad crossing is within 200 feet of an intersection, the design should address efforts to keep vehicles from stopping or storing on the tracks. This applies to either signal- or stop-controlled intersections. The following factors should be identified and considered during the planning stages:

1. Clear Storage Distance. Consider alternative designs that provide a minimum distance of 75 feet between the proposed intersection stop line and a point 6 feet from the closest rail.
2. Space for Vehicular Escape. On the far side of any railroad crossing, consider providing an escape area for vehicles (e.g., shoulder with curb and gutter behind the shoulder, flush medians, flush-corner islands, right-turn acceleration lanes, improved corner radii).
3. Conflicting Commercial Access. Left-turn vehicular movements that may inhibit the clearance of queued traffic on the approaches to railroad tracks should be discouraged. If entrances on the street approach exist, consider using design features that would eliminate the problems (e.g., left-turn lane, raised-curb median).
4. Restricted Intersection Capacity. During periods of frequent railroad preemption of traffic signals, consider the effects of reduced traffic flow, lack of progression on the street paralleling the tracks and traffic backups. Available computer programs should be used to analyze different capacity and operational scenarios and to recommend any countermeasures.
5. Protected Left-Turn Storage. On the street that parallels the tracks, analyze the storage length needed for left turns into the side street and across the tracks during preemption of the traffic signals. Without the proper storage length available, this could cause backups into the through lanes.
6. Right-Turn Lanes. On the street which runs parallel to the railroad and where an actuated NO RIGHT TURN sign is proposed in conjunction with railroad preemption, a right-turn lane should be considered for the right-turn movement across the tracks. The auxiliary lane provides a refuge for right-turning vehicles during railroad preemption and eliminates the problem of traffic temporarily blocking the through lanes.

7. Side Street Left-Turn Lane Capacity. On streets that cross railroad tracks, provide sufficient left-turn storage lengths. This will avoid the problem of left turns spilling out onto through lanes and blocking the through lanes.

15.8.2 Interconnection Traffic Signal System Design

15.8.2.1 General

Where a signalized intersection is located within 200 feet of a railroad grade crossing or where traffic frequently queues onto the tracks, the normal sequence of the traffic signals should be preempted upon approach of trains to avoid entrapment of vehicles on the crossings. The primary focus of the design of intersections where a railroad grade crossing is within 200 feet should be to provide adequate storage area for vehicles between the track and intersection and to keep vehicles from stopping on the tracks while waiting for a green signal at the intersection.

15.8.2.2 Coordination

Close coordination between the Department and the railroad company is required to insure that the railroad warning signal and the traffic signal are performing as a system. The Traffic Engineering Division will be responsible for reviewing the interconnected traffic signal design.

15.8.3 Sight Distance

Two sight distance applications must be addressed at railroad crossings:

1. Case A. This sight distance is required by the motorist that will allow the driver to either pass through the grade crossing prior to the train's arrival or to stop the vehicle prior to encroachment in the crossing area.
2. Case B. A motorist who is stopped at the crossing and then decides to cross the tracks requires this sight distance.

[Figure 15.8A](#) illustrates these two sight distance measurements. [Figure 15.8B](#) provides the sight distance values for both Case A and Case B. These criteria are appropriate for railroad/highway intersections at 90 degrees; adjustments should be made for skewed intersections. Additional guidance on railroad crossing sight distance can be found in *AASHTO A Policy on Geometric Design of Highways and Streets*.

15.8.4 Horizontal Alignment

Where practical, the alignment of the highway and railroad crossing should intersect at 90 degrees, and neither the highway nor the railroad should be on a horizontal curve. If these objectives are met, this will enhance driver safety and comfort; it will reduce maintenance problems; and it will improve roadway rideability. The designer should review [Chapter 11](#) for SCDOT criteria on horizontal alignment for highways.

15.8.5 Vertical Alignment

Desirably, the highway will be relatively level where it crosses the railroad. Where vertical curves are provided, they should meet SCDOT criteria for vertical alignment presented in [Chapter 12](#). [Figure 15.8C](#) presents the minimum design for vertical alignment at railroad crossings to prevent low-clearance vehicles from bottoming out on the tracks. This design should be provided unless railroad track superelevation dictates otherwise.

15.8.6 Grade Crossing Surface

The railroad company in coordination with the Utilities Office will select the grade crossing surface type. The designer should contact the Utilities Office to determine what measures will be required to connect to the grade crossing.

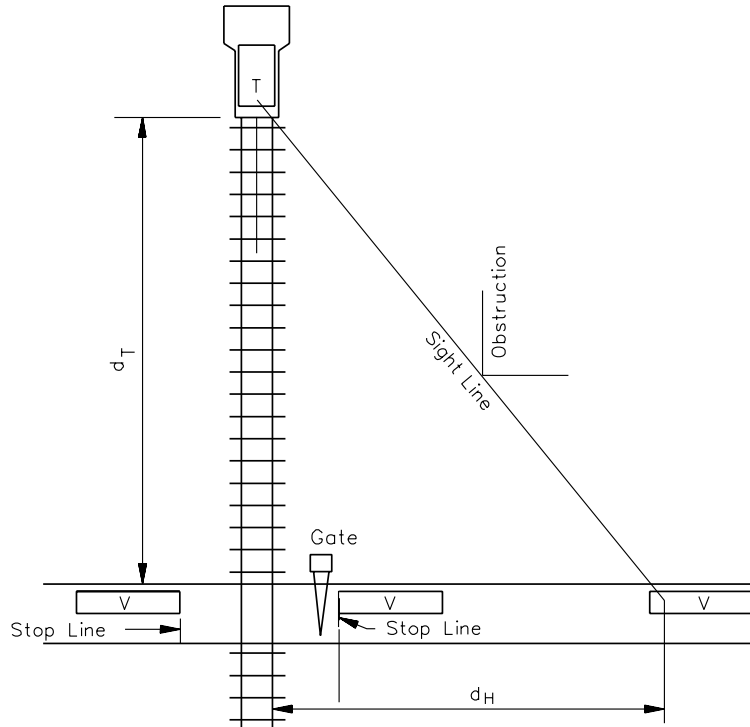

(a) APPROACHING VEHICLE

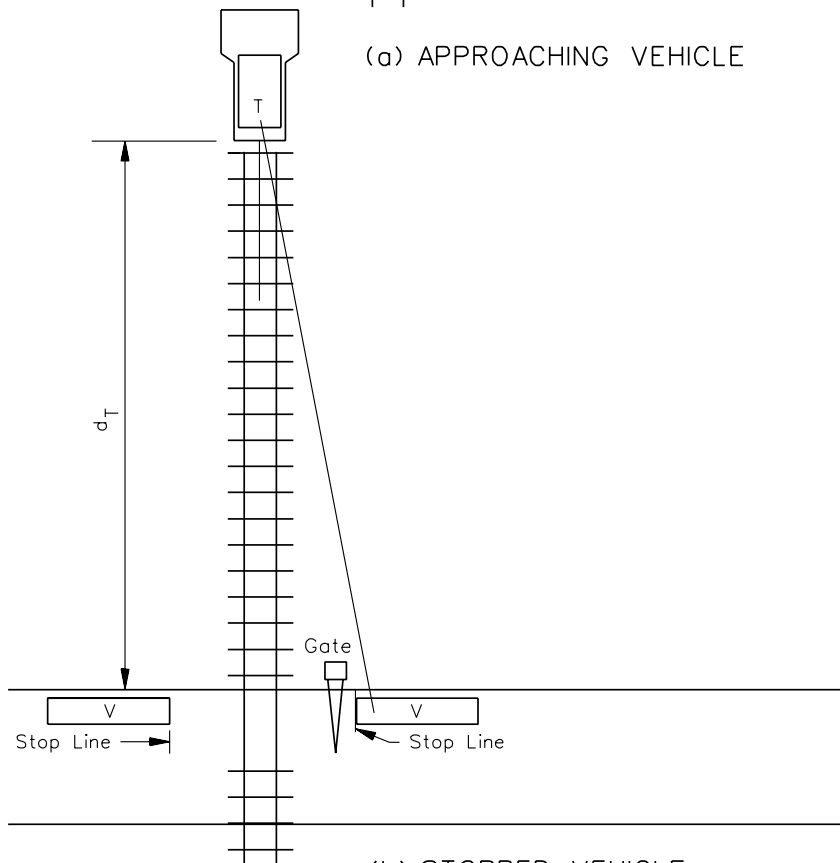

(b) STOPPED VEHICLE

SIGHT LINES AT RAILROAD CROSSING
Figure 15.8A

Train Speed (mph)	Case B Departure from stop 0	Case A Moving Vehicle							
		Vehicle Speed (mph)							
		10	20	30	40	50	60	70	80
		Distance along railroad from crossing, d_T (ft)							
10	240	146	106	99	100	105	111	118	126
20	480	293	212	198	200	209	222	236	252
30	721	439	318	297	300	314	333	355	378
40	961	585	424	396	401	419	444	473	504
50	1201	732	530	494	501	524	555	591	630
60	1441	878	636	593	601	628	666	709	756
70	1681	1024	742	692	701	733	777	828	882
80	1921	1171	848	791	801	838	888	946	1008
90	2162	1317	954	890	901	943	999	1064	1134
		Distance along highway from crossing, d_H (ft)							
	All	71	137	222	326	449	591	753	933

SIGHT DISTANCE AT RAILROAD CROSSINGS

Figure 15.8B

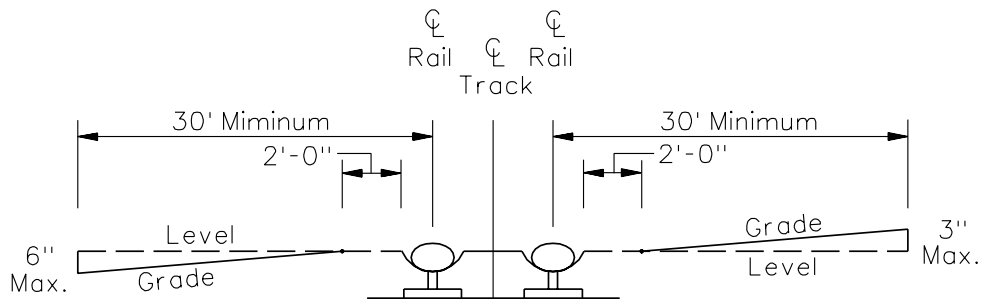

PROFILE AT RAILROAD/HIGHWAY GRADE CROSSINGS

Figure 15.8C

15.9 REFERENCES

1. *A Policy on Geometric Design of Highways and Streets*, AASHTO, 2001.
2. *Highway Capacity Manual 2000*, Transportation Research Board, 2000.
3. *Roundabouts: An Information Guide*, FHWA RD-00-067, FHWA, June 2000.
4. *Manual on Uniform Traffic Control Devices, Millennium Edition*, FHWA, ATSSA, AASHTO and ITE, 2001.
5. *South Carolina Manual on Uniform Traffic Control Devices*, SCDOT, 1994.
6. *Driveway and Street Intersection Spacing*, Transportation Research Circular 456, Transportation Research Board, March 1996.
7. *Highway Research Record 211*, "Volume Warrants for Left-Turn Storage Lanes at Unsignalized Grade Intersections," M.D. Harmelink, 1967.
8. NCHRP 375, *Median Intersection Design*, Transportation Research Board, 1995.
9. *Capacities of Multiple Left-Turn Lanes*, Institute of Transportation Engineers, 1993.
10. *Highway Safety Design and Operations Guide*, AASHTO, 1997.
11. NCHRP Synthesis 225, *Left-Turn Treatments at Intersections*, TRB, 1996.
12. NCHRP 279, *Intersection Channelization Design Guide*, Transportation Research Board, 1985.
13. NCHRP Synthesis 271, *Traffic Signal Operations Near Highway-Rail Grade Crossings*, Transportation Research Board, 1999.
14. *Preemption of Traffic Signals At or Near Railroad Grade Crossing with Active Warning Devices*, Institute of Transportation Engineers, 1997.

Table of Contents

<u>Section</u>	<u>Page</u>
16.1 GENERAL	16.1(1)
16.1.1 Responsibility	16.1(1)
16.1.2 Interchange Warrants	16.1(2)
16.1.3 New/Reconstructed Interchanges.....	16.1(3)
16.1.3.1 Changes in Access.....	16.1(3)
16.1.3.2 Processing Procedures	16.1(3)
16.1.3.3 Documentation of Requests	16.1(4)
16.1.4 Grade Separation Versus Interchange	16.1(6)
16.2 INTERCHANGE TYPES AND SELECTION.....	16.2(1)
16.2.1 General.....	16.2(1)
16.2.2 Conventional Diamond	16.2(1)
16.2.3 Split Diamond	16.2(4)
16.2.4 Compressed Diamond.....	16.2(4)
16.2.5 Single-Point Urban Diamond	16.2(6)
16.2.6 Full Cloverleaves.....	16.2(7)
16.2.7 Partial Cloverleaves	16.2(10)
16.2.8 Three-Leg Interchanges	16.2(12)
16.2.8.1 T-Type or Trumpet.....	16.2(12)
16.2.8.2 Y-Type (Directional).....	16.2(12)
16.2.9 Directional and Semi-Directional Interchanges.....	16.2(14)
16.2.10 Selection.....	16.2(16)
16.2.10.1 Evaluation Factors.....	16.2(16)
16.2.10.2 General Considerations.....	16.2(16)
16.2.10.3 Capacity (Traffic Volume) Considerations	16.2(18)
16.2.10.4 Summary	16.2(20)
16.3 INTERCHANGE SYSTEM OPERATIONS AND DESIGN	16.3(1)
16.3.1 Interchange Spacing.....	16.3(1)
16.3.2 Distance Between Successive Freeway/Ramp Junctions	16.3(2)
16.3.3 Basic Number of Lanes	16.3(2)
16.3.4 Lane Balance.....	16.3(2)
16.3.5 Capacity and Level of Service	16.3(5)

Table of Contents

(Continued)

<u>Section</u>	<u>Page</u>
16.3.6 Auxiliary Lanes	16.3(6)
16.3.7 Weaving Sections	16.3(6)
16.3.8 Collector-Distributor Roadways	16.3(8)
16.3.8.1 Usage	16.3(8)
16.3.8.2 Design	16.3(8)
16.3.9 Route Continuity	16.3(9)
16.3.10 Uniformity	16.3(9)
16.3.11 Left-Hand Ramps	16.3(9)
16.3.12 Signing and Marking	16.3(10)
16.3.13 Ramp Metering	16.3(10)
16.3.14 Grading and Landscaping	16.3(10)
16.3.15 Operational/Safety Considerations	16.3(10)
16.3.16 Geometric Design Criteria	16.3(12)
16.3.17 Reviewing for Ease of Operation	16.3(14)
16.4 FREEWAY/RAMP JUNCTIONS	16.4(1)
16.4.1 Exit Ramps	16.4(1)
16.4.1.1 Types of Exit Ramps	16.4(1)
16.4.1.2 Taper Rates	16.4(1)
16.4.1.3 Deceleration	16.4(4)
16.4.1.4 Sight Distance	16.4(6)
16.4.1.5 Horizontal Alignment	16.4(6)
16.4.1.6 Cross Slope Rollover	16.4(7)
16.4.1.7 Shoulders	16.4(8)
16.4.1.8 Gore Area	16.4(8)
16.4.2 Entrance Ramps	16.4(10)
16.4.2.1 Types	16.4(10)
16.4.2.2 Taper Rates	16.4(13)
16.4.2.3 Acceleration	16.4(13)
16.4.2.4 Sight Distance	16.4(18)
16.4.2.5 Superelevation	16.4(18)
16.4.2.6 Cross Slope Rollover	16.4(18)
16.4.2.7 Shoulder Transitions	16.4(18)
16.4.2.8 Gore Area	16.4(18)

Table of Contents

(Continued)

<u>Section</u>	<u>Page</u>
16.4.3 Multilane Terminals	16.4(19)
16.4.4 Major Fork/Branch Connections	16.4(19)
16.5 RAMP DESIGN	16.5(1)
16.5.1 Ramp Types	16.5(1)
16.5.1.1 Loop Ramps	16.5(1)
16.5.1.2 Diagonal Ramps	16.5(1)
16.5.1.3 Outer-Connector Ramps	16.5(1)
16.5.1.4 Semi-Directional Ramps	16.5(3)
16.5.1.5 Directional Ramps	16.5(3)
16.5.2 Design Speed	16.5(3)
16.5.3 Sight Distance	16.5(4)
16.5.4 Cross Section Elements	16.5(6)
16.5.5 Horizontal Alignment	16.5(8)
16.5.6 Vertical Alignment	16.5(12)
16.5.6.1 Grades	16.5(12)
16.5.6.2 Vertical Curvature	16.5(12)
16.5.6.3 Cross Sections Between Adjacent Ramps	16.5(13)
16.6 RAMP/CROSSROAD INTERSECTION	16.6(1)
16.7 REFERENCES	16.7(1)

Chapter Sixteen

INTERCHANGES

16.1 GENERAL

An interchange is a system of ramps in conjunction with one or more grade separations that provides for the movement of traffic between two or more roadways on different elevation levels. The operational efficiency, capacity, safety and cost of the highway facility are largely dependent upon its design. This Chapter provides guidance in the design of interchanges including type, selection, operations, spacing, freeway/ramp terminals, ramps and ramp/crossroad terminals.

16.1.1 Responsibility

The following units are responsible for the planning and design of an interchange:

1. New Access Review. The Program Manager is responsible for requests to FHWA for new Interstate access.
2. Interchange Type Selection. Once it has been determined that an interchange is justified, the Preliminary Design Group, in conjunction with the Traffic Engineering Division and the Program Manager, will conduct an engineering study to determine the appropriate interchange type for the site.
3. Access Control. The Preliminary Design Group, the Traffic Engineering Division and the Program Manager will determine the type of access control and right of way limits that will be provided along the interchange.
4. Geometric Layout. The engineering study will assist in determining the interchange layout including the horizontal alignment, the preliminary profile grade line and basic ramp/crossroad intersection design.
5. Interchange Design. The Road Design Section determines the final vertical alignment, earthwork quantities and contour grading plans.
6. Detailed Sheets. The Road Design Section will prepare the detailed sheets that will be included in the Plans.
7. Consultant Projects. On consultant-designed interchange projects, the consultant will be responsible for the design of all elements including type selection, geometric layout, traffic engineering, electrical work, drainage design, ramp/crossroad intersection details and detailed plan preparation. The Preliminary Design Group, Hydraulic Engineering Section, Traffic Engineering Division and the Program Manager will review these items.

16.1.2 Interchange Warrants

High cost and environmental impact require interchanges be used only after careful consideration of its merits. Because of the variance in specific site conditions, SCDOT has not adopted specific interchange warrants. When determining the need for an interchange or grade separation, consider the following:

1. Access Control. The following will apply:
 - a. Full Access Control. On all fully access-controlled facilities, intersecting crossroads must be terminated, rerouted, grade separated or an interchange provided. The importance of the continuity of the crossroad, the feasibility of an alternative route, traffic volumes, construction costs, environmental impacts, etc., are evaluated to determine which option is most practical. Interchanges generally are provided at:
 - all freeway-to-freeway crossings;
 - all major highways, unless determined inappropriate; and
 - other highways based on the anticipated demand for regional access.
 - b. Partial Access Control. On facilities with partial access control (expressways), intersections with public roads will be accommodated by an interchange or with an at-grade intersection. Generally, it will be rare that a grade separation or an interchange will be provided where the facilities are not access controlled, topography limits the potential to provide grade separation or costs are prohibitive. However, an interchange may still be a viable option for high-volume intersecting roads when considering [Items 2](#) through [6](#).
 - c. No Access Control. An interchange will rarely be warranted on a facility with no access control. The need for an interchange will be determined on a case-by-case basis emphasizing cost effectiveness, safety and operations. A road-user benefit analysis will generally be required to determine the economic feasibility of an interchange. See [Item 5](#). However, this analysis alone is not a sufficient justification for the provision of an interchange.
2. Safety. In special cases, consider the crash-reduction benefits of an interchange at an existing intersection that exhibits extremely high-crash frequencies or rates.
3. Site Topography. Where access is necessary, the topography may dictate an interchange or a grade separation rather than an intersection.
4. Road-User Benefits. If an analysis reveals that road-user benefits over the service life of the interchange will exceed costs, then an interchange may be

considered. The designer must consider all costs including right of way, construction, maintenance and user costs in the analysis. For additional guidance, the designer may refer to the AASHTO publication *A Manual on User Benefit Analysis of Highway and Bus-Transit Improvements*.

5. Access. An interchange may be required in an area where access availability from other sources is not practical and the freeway is the only facility that serves the area.
6. Traffic Volumes. Although there are no specific traffic volumes that warrant an interchange, consider providing an interchange where the traffic volumes at an intersection are at or near capacity and where other improvements are not practical. Consider providing an interchange where the level of service (LOS) at an intersection is unacceptable and the intersection cannot be redesigned to operate at an acceptable LOS.

16.1.3 New/Reconstructed Interchanges

16.1.3.1 Changes in Access

In general, all new and/or revised access points should be minimized on existing fully access-controlled facilities. Each entrance and exit point on the mainline, including “locked gate” access (e.g., utility opening), is defined as an access point. A revised access includes changes in an existing interchange configuration although the number of access points may not change.

The designer must demonstrate that an additional access point or revision is required for regional traffic demand and not just to solve local system needs or problems. The Interstate and other freeway facilities, including the interchange crossroad and ramps, should not be allowed to become a part of the local circulation system but should be maintained to handle regional traffic demands.

16.1.3.2 Processing Procedures

SCDOT and FHWA must approve all proposed changes in interchange configurations on the Interstate System, even if the number of access points does not change. See the *Federal Register*, Vol. 55, No. 204, Monday, 10-22-90 and *Federal Register*, Vol. 63, No. 28, Wednesday, 2-11-98. [Section 16.1.3.3](#) summarizes the criteria from the *Federal Register*.

The following procedures are applicable where 1) the highway is on the State Highway System and Federal funds were used for right of way and/or construction costs of the roadway segment; and 2) the highway is access controlled and the proposed access revisions will modify previous commitments made in environmental documents:

1. Environmental Study Determination. The Environmental Management Office will determine the type and scope of the necessary environmental process in cooperation with FHWA; see [Chapter 27](#). Depending upon the magnitude of the proposed changes, a revision in access control may create impacts that require discussion in the appropriate environmental document.
2. Secondary Impacts. Determine the secondary impacts associated with the proposed access revisions based on traffic-induced impacts on the highway facility and on the potential environmental impacts on the surrounding area. Because the area of influence on the highway facilities and surrounding land use will vary, describe the limits of influence for each case prior to determining impacts.
3. Outside Agency Proposals. The Program Manager will recommend whether SCDOT or the agency requesting the revision will conduct the studies.
4. FHWA Coordination. The Preconstruction Division, in conjunction with the Traffic Engineering Division, usually will review and approve the interchange type and interchange design. For Interstates and NHS projects, FHWA must also approve the interchange type and design details.

16.1.3.3 Documentation of Requests

All requests for changes in access must include the following:

1. Traffic Volumes. A capacity analysis must be performed to determine if an existing facility does not provide the necessary access nor can it be improved to accommodate the expected design year LOS.
2. Alternatives. The request must demonstrate that all reasonable alternatives for design options, locations and transportation system management (TSM) type improvements (e.g., ramp metering, mass transit, HOV facilities) have been evaluated, provided for and/or provision made for future incorporation.
3. Impacts. The proposed new access point must not have a significant adverse impact on the safety and operation of the freeway facility based on an analysis of current and future traffic (e.g., 20 years in the future). The investigations of traffic operations related to existing conditions should include:
 - an analysis of adjacent freeway sections including the distance to the next interchange in each direction; and
 - a capacity analysis of crossroads and other roads/streets to insure their ability to collect and distribute traffic to and from the proposed interchange.

- The request must demonstrate if acceptable merge and diverge lengths are available and if adequate signing can be provided.
4. Connections. The proposed new interchange should only connect to a public road and must provide for all traffic movements. Less than “full interchanges” will only be considered for special purposes (e.g., access for transit vehicles, HOV entrances, park-and-ride lots) and will be determined on a case-by-case basis.
 5. Land Use. The request must evaluate the consistency between the interchange and local and regional development plans and transportation system improvements. Include information on the distance to and size of communities directly served by the interchange. For possible multiple interchange additions, a comprehensive Interstate/freeway network study that addresses all proposed and desired access within the context of a long-term plan must support the proposal.
 6. New/Expanded Developments. Where new or revised access is requested due to proposed or expanded development, document that appropriate coordination has taken place with the developer in conjunction with other transportation system improvements. Prior to the new access being approved, confirm that a sufficient analysis of parallel facilities and crossroads are complete to insure that local roads can adequately accommodate the additional traffic volumes.
 7. Design. Insure that the Department’s and/or FHWA’s design criteria for interchanges have been met or are adequately addressed.
 8. Planning/Environmental. Insure that the request for new or revised access contains information relative to the planning requirements and the status of the environmental processing of the proposal.
 9. Capacity Analyses. Include the following information with the capacity analyses:
 - current and future design hour traffic volumes for mainline traffic and for each ramp movement;
 - current and proposed basic information including the number of lanes on the mainline and for each ramp, the distances in each direction between proposed ramps, and existing ramps on adjacent interchanges;
 - layout (including number of lanes) for ramp intersections with crossroad and LOS;
 - information on the terrain, either in general terms or, if necessary, specific grades if they affect the operations in the area;
 - overall peak-hour factor and percentage of trucks on the mainline and on each ramp; and

- current and proposed signal phasing and pedestrian volumes at signalized intersections with the crossroad and ramps.

16.1.4 Grade Separation Versus Interchange

[Section 19.4.2](#) discusses the justification for a grade separation and general design considerations. [Section 19.4.2](#) also presents criteria for determining if the major road should pass over or under the crossroad. Once it has been determined to provide a grade-separated crossing, the need for access between the two roadways must be evaluated to determine if an interchange is appropriate. The following lists several guidelines to consider in the evaluation:

1. Functional Classification. Provide an interchange at all freeway-to-freeway crossings. On fully access-controlled facilities, provide an interchange with all major highways, unless this is determined inappropriate for other reasons (e.g., terrain). Interchanges to other highways should be provided if practical.
2. Site Conditions. Site conditions that may be adaptable to a grade separation may not always be conducive to an interchange. Restricted right of way, environmental concerns, rugged topography, etc., may restrict the practical use of an interchange.
3. Interchange Spacing. Freeway operations are improved with increased interchange spacing. See [Section 16.3.1](#) for guidance on interchange spacing. If these criteria cannot be met, this may favor the use of a grade separation rather than an interchange.
4. Operations. Grade-separated facilities without ramps will allow traffic to cross the facility. All drivers desiring to turn onto the crossroad must use other locations to make their desired moves. This will often improve the operations of the major facility by concentrating the access to a few strategically placed locations. Concentration of the access movements at specific locations will affect the operation of the interchange.

16.2 INTERCHANGE TYPES AND SELECTION

16.2.1 General

SCDOT uses six basic interchange types — the diamond, the cloverleaf, the partial cloverleaf, the three-leg interchange, the directional and the semi-directional. These interchange types, and variations within each type, permit adaptation to traffic needs, available right of way, terrain and cultural features. The following Sections discuss these basic interchange types and the design elements for laying out the interchange. Each interchange must be designed to fit the individual site considerations. The final design may be a minor or major modification of one of the basic types or may be a combination of two or more basic types.

[Section 16.2.10](#) discusses the selection of an interchange type.

16.2.2 Conventional Diamond

The conventional diamond is the simplest and most common interchange type. Diamonds include one-way diagonal ramps in each quadrant and two intersections at the crossroad. With proper treatments at the crossroad (e.g., intersection capacity, adequate storage distance between ramps, vertical and horizontal alignment), the diamond is often the best interchange choice where the intersecting road is not access controlled. [Figure 16.2A](#) illustrates a typical diamond interchange without frontage roads. [Figure 16.2B](#) illustrate a typical diamond interchange with frontage roads. Some of the advantages and disadvantages of a conventional diamond include:

Advantages

1. All exits from the mainline occur before reaching the crossroad structure and entrances occur after the structure. This conforms to driver expectancy and therefore minimizes confusion.
2. All traffic can enter and exit the mainline at relatively high speeds. The operational maneuvers are normally uncomplicated.
3. At the crossroad, adequate sight distance can usually be provided, and the operational maneuvers are consistent with other intersections on the crossroad.
4. The diamond requires less right of way than other interchange types.
5. Their common usage has resulted in a high level of driver familiarity.
6. Typically, it is the least expensive of all interchange types.

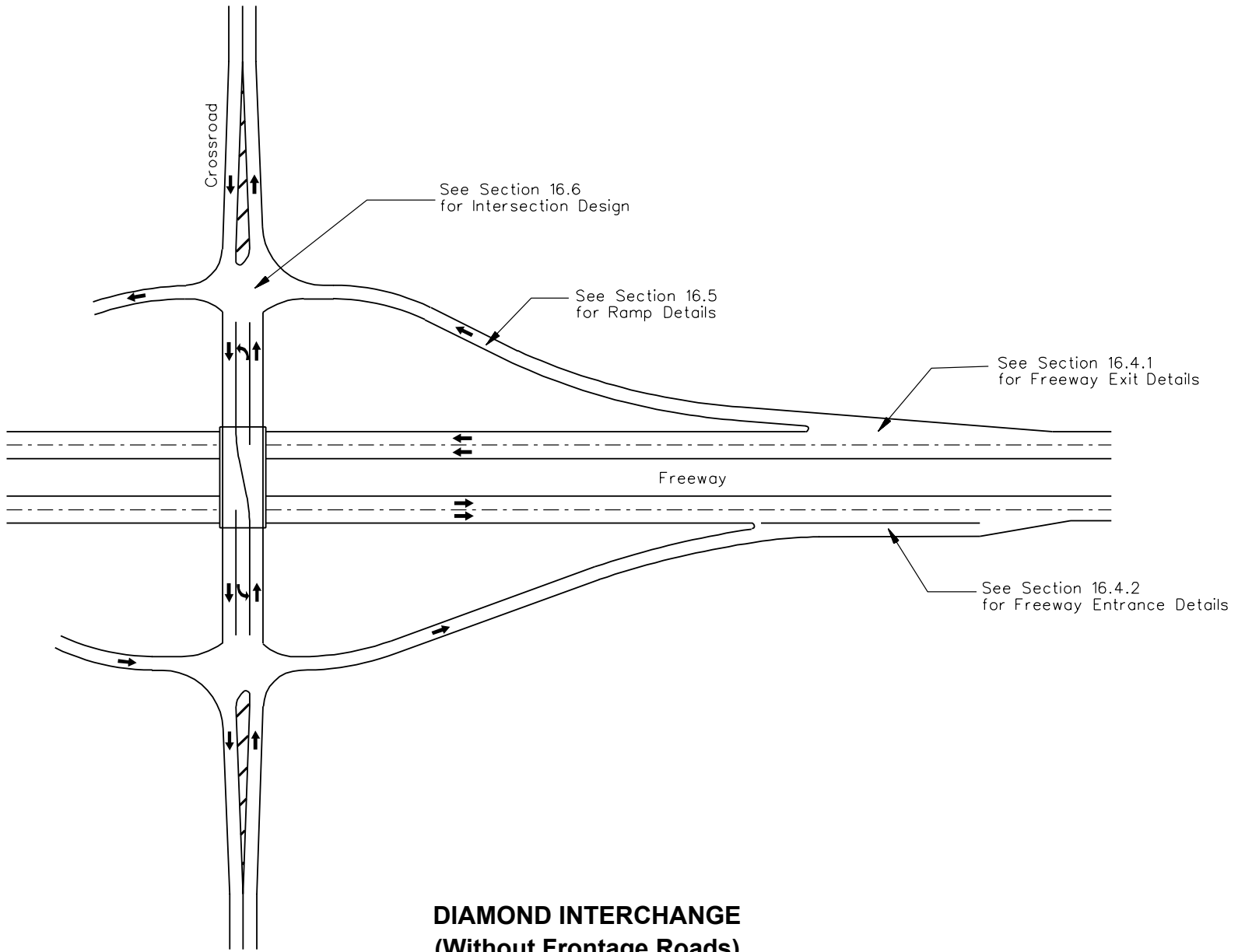

**DIAMOND INTERCHANGE
(Without Frontage Roads)**

Figure 16.2A

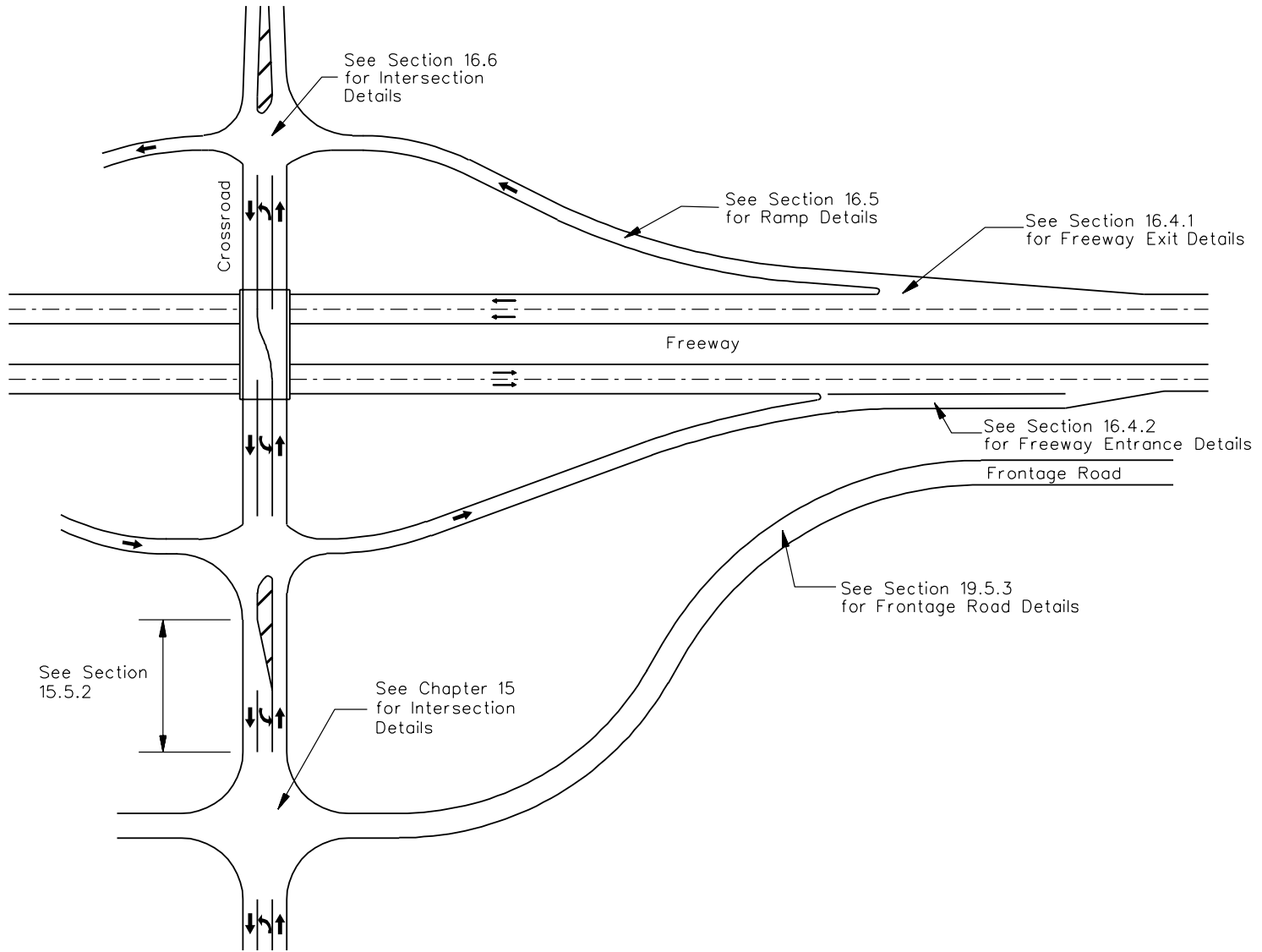

**DIAMOND INTERCHANGE
(With Frontage Roads)**

Figure 16.2B

Disadvantages

1. There are potential operational problems with the two at-grade intersections at the crossroad (e.g., sight distance, left-turn storage between ramps, signal coordination).
2. Traffic is subject to stop-and-go operations rather than free flow.
3. In suburban and urban areas, signalization is generally required at the crossroad intersections. These signals should be interconnected for progression. Signalization may also produce vehicular platoons entering the freeway, which may cause congestion in the freeway/ramp merge area.
4. A diamond requires right of way in all four quadrants of the interchange.
5. A diamond has a greater potential for wrong-way entry onto the ramps than, for example, a full cloverleaf.

16.2.3 Split Diamond

A variation of the conventional diamond is a split diamond interchange. Split diamonds are normally used in urban or suburban areas where the designer desires to provide access to two crossing roadway facilities (desirably one-way pairs within 500 feet of each other) that are spaced less than one mile apart. Normally, separate interchanges cannot be located within this distance without creating substandard geometric conditions and/or weaving problems without the use of collector-distributor (C-D) roads. It is desirable to make the connecting roadways (between the two crossroads) one-way with control of access. Split diamonds have an undesirable feature in that traffic leaving the freeway cannot return at the same interchange point and continue in the same direction.

16.2.4 Compressed Diamond

A compressed diamond, also called a tight diamond interchange, is similar to the conventional diamond except that the ramp termini on the crossroad are located near the structure. [Figure 16.2C](#) presents a schematic of a compressed diamond interchange without frontage roads. This design type is generally only used in urban areas where a diamond interchange is appropriate but right of way or other environmental features preclude the use of the conventional diamond. Although operationally a compressed diamond is similar to a single-point diamond discussed in [Section 16.2.5](#), they have significant differences. Some of the advantages and disadvantages of the compressed diamond include:

Advantages

1. Generally, less right of way is required than that for a conventional diamond.
2. The open pavement area at the intersection is significantly less than that for a single-point diamond.
3. The grade separation structure is smaller than that for a single-point diamond, retaining walls and/or embankments are less expensive, and construction costs are lower.

Disadvantages

1. Left-turn lanes between the ramp termini usually need to be overlapped (i.e., side-by-side opposing left-turn lanes). Consequently, the cross section of the crossroad is generally wider than a conventional diamond.
2. Signal timing and interconnection are necessary to eliminate left-turn queues from overlapping upon each other and causing gridlock.
3. Due to the close proximity of the two intersections, the compressed diamond typically will need to operate as a six-phase overlap signal system. Consequently, longer clearance times are required.
4. The length of access control on the crossroad may be more extensive than for a conventional diamond.
5. A diamond has a greater potential for wrong-way entry onto the ramp than a regular diamond.
6. There is the potential for the left turn lane queue to block ramp access.

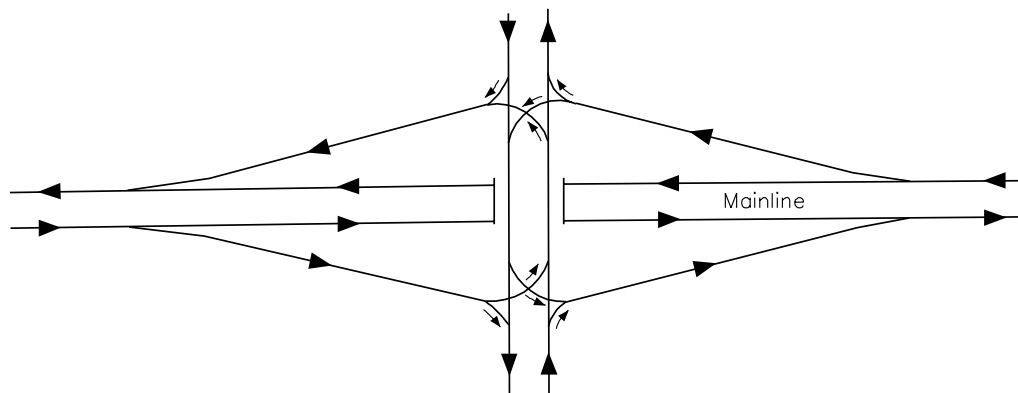

COMPRESSED DIAMOND INTERCHANGE

Figure 16.2C

16.2.5 Single-Point Urban Diamond

The single-point urban diamond interchange (SPUI) offers improved traffic-carrying capabilities, safer operations and reduced right of way needs under certain conditions when compared with other interchange configurations. The distinguishing feature of this interchange is the convergence of all through and left-turning movements into a single, large signalized intersection area. [Figure 16.2D](#) illustrates a schematic of a SPUI. Some of its advantages and disadvantages include:

Advantages

1. The SPUI only requires one intersection instead of two intersections at a typical diamond.
2. It allows for better traffic signal progression on the crossroad.
3. The SPUI can increase interchange capacity and alleviate storage problems from two closely spaced intersections on the crossroad.
4. Opposing left turns operate to the left of each other so that their paths do not cross each other.
5. Less right of way is required than any other interchange type.
6. At the intersection of the ramps with the crossroad, the design typically includes flatter curves for turning radii, which allows left turns to be completed at higher speeds.

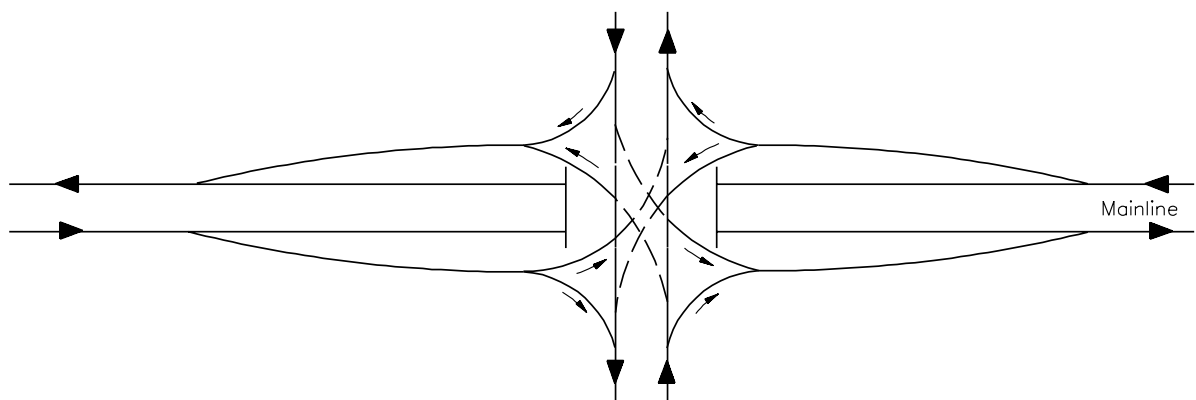

SINGLE-POINT URBAN DIAMOND INTERCHANGE

Figure 16.2D

Disadvantages

1. Special pavement markings and a centrally located diamond-shaped island are required to guide the left-turning drivers through the intersection.
2. There is a significantly wider pavement area for pedestrians to cross, and the SPUI may create greater delays in traffic when compared to the conventional diamond.
3. Because of wide pavement areas, it requires longer signal clearance times.
4. The SPUI has a higher cost than the conventional or compressed diamond because of the need for a long, single-span structure and the need for retaining walls or reinforced earth walls along the mainline.
5. Where the mainline is over a crossroad, lighting is required under the structure.

See NCHRP 345 *Single-Point Urban Interchange Design and Operational Analysis* for complete design details of a SPUI.

16.2.6 Full Cloverleafs

Cloverleaf interchanges are used at four-leg intersections and employ loop ramps to accommodate left-turn movements. Full cloverleaf interchanges are those with loops in all four quadrants; all others are partial cloverleafs; see [Section 16.2.7](#).

Where two access-controlled highways intersect, a full cloverleaf is the minimum type of interchange design that will suffice. In addition, they also may be used at the intersection of other multilane arterials to accommodate large volumes of traffic.

The operation of a cloverleaf with high weaving volumes is greatly improved through the addition of collector-distributor (C-D) roadways; see [Section 16.3.8](#). The C-D roadways may be advantageous in suburban areas because of the need for smaller loops. This may reduce the amount of right of way acquisition necessary for the development of the interchange. Although right of way requirements may be reduced, overall costs usually increase due to longer and wider structures and additional pavement costs.

[Figure 16.2E](#) provides typical examples of full cloverleafs with and without C-D roads.

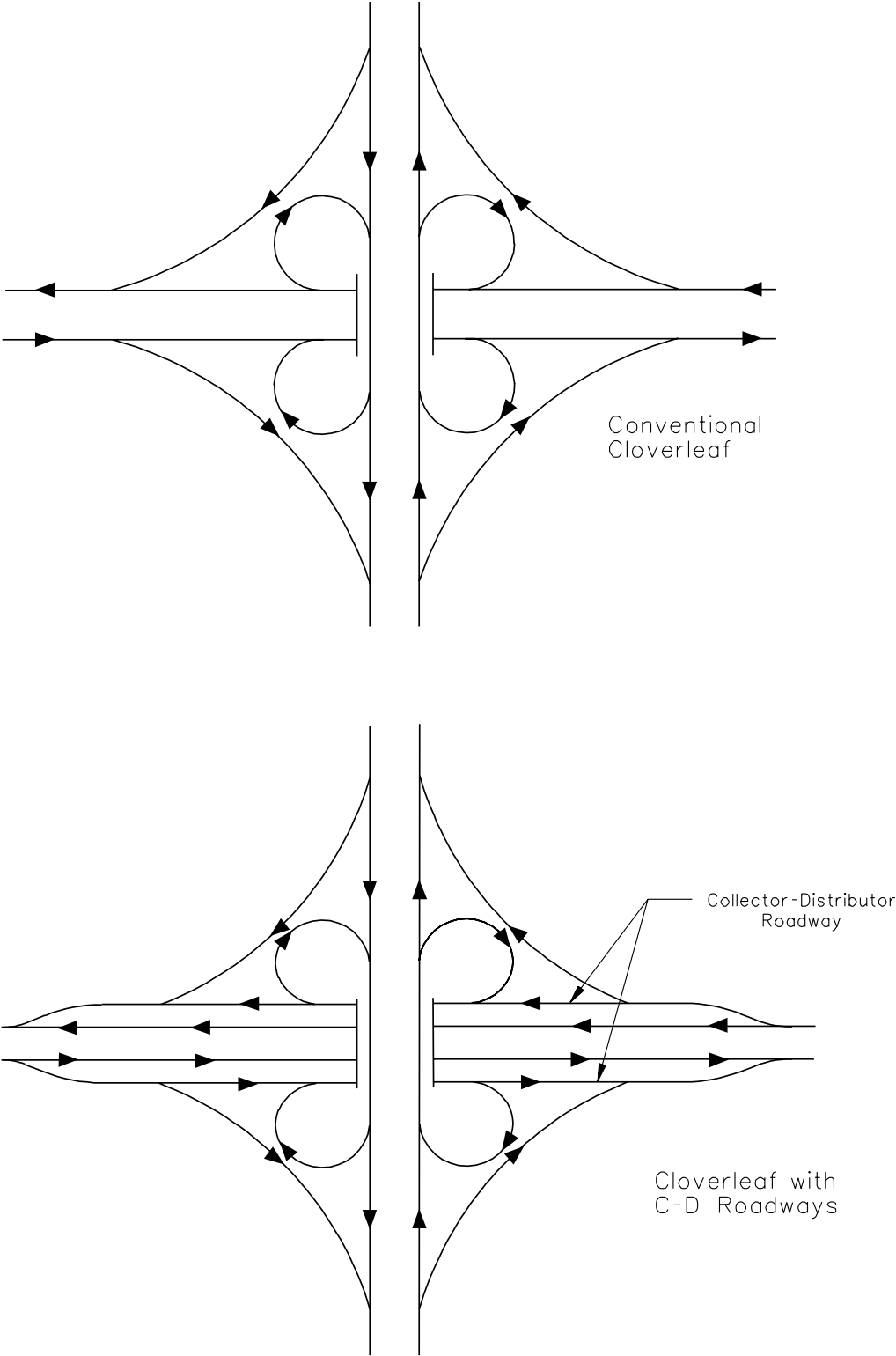

CLOVERLEAF INTERCHANGES

Figure 16.2E

Some of the advantages and disadvantages of full cloverleaves include:

Advantages

1. Full cloverleaves eliminate all vehicular stops through the use of free-flow terminals, and they provide continuous free-flow operation on both intersecting highways.
2. Full cloverleaves eliminate all at-grade intersections, eliminate left turns across traffic and, therefore, eliminate the need for traffic signals.

Disadvantages

1. Because of the geometric design of loops, full cloverleaves require large amounts of right of way.
2. They are typically more expensive than diamond interchanges due to considerably lengthier ramps, wider structures and, if provided, the additional cost of C-D roads.
3. The loops in cloverleaves result in a greater travel distance for left-turning vehicles than do diamonds, and the speeds on the ramps are generally slower.
4. Exit and entrance terminals are located before and after the crossroad structure, which require additional signing to guide motorists.
5. Weaving sections between loop ramps must be long enough to provide for satisfactory traffic operations.
6. Where the crossroad is an expressway or other multilane highway, a considerable length of access control distance is needed along the crossroad to the first point of access.
7. Pedestrian movements are difficult to accommodate.

Operational experience with full-cloverleaf interchanges has yielded several observations on their design. Subject to a detailed analysis on a site-by-site basis, the following generally characterize the design of cloverleaves:

1. Design Speed Impacts. For an increase in design speed, there will be an increase in travel distance and required right of way.
2. Loop Radii. Design of loop radii is highly dependent on the relative design speed of the two crossing roadways. Consistency with the exit speed on the upstream end and entrance speed requirements on the downstream end are essential.

3. Loop Geometry. Circular curve loop ramps are desirable geometrically because speeds and travel paths tend to be more constant and uniform. However, compound curves are often used as site conditions dictate. Transition of the design speed from curve to curve into and out of the loop is critical.
4. Loop Capacity. Expected design capacities for single-lane loops range from 800 to 1200 vehicles per hour. The higher volumes are generally only achievable where the design speed is 30 miles per hour or higher and few trucks use the loop.
5. Weaving Volumes. An auxiliary lane is typically provided between successive entrance/exit loops within the interior of a cloverleaf interchange. This produces a weaving section between the mainline and entering/exiting traffic. Where the total volume on the two successive ramps reaches approximately 1000 vehicles per hour, there may be a significant reduction of the through travel speed and level of service. Where this occurs, consider providing collector-distributor roadways.
6. Weaving Lengths. The minimum weaving length between the exit and entrance gores of loops on new cloverleaf interchanges without collector-distributor roadways or those undergoing major reconstruction should be at least 1000 feet or the distance determined by a capacity analysis, whichever is greater.
7. Collector-Distributor Roadways. The consideration of collector-distributor roadways should be an integral part of cloverleaf design. They deploy the exit in advance of the crossroad and encourage a lower speed weaving area, which is easier to match with the loop design.

16.2.7 Partial Cloverleafs

Partial cloverleaf interchanges are those with loops in one, two or three quadrants. See [Figure 16.2F](#). Several of the advantages and disadvantages for full cloverleafs also apply to partial cloverleafs (e.g., geometric restriction of loops). However, some specific advantages of partial cloverleafs include:

1. Partial cloverleafs provide access where one or more quadrants present adverse right of way and/or topographic problems that preclude a typical diamond interchange.
2. Partial cloverleafs may accommodate heavy left-turn traffic by means of a loop and thereby improve capacity, operations and safety.
3. Depending upon site conditions, partial cloverleafs may offer the opportunity to eliminate or increase weaving distances.

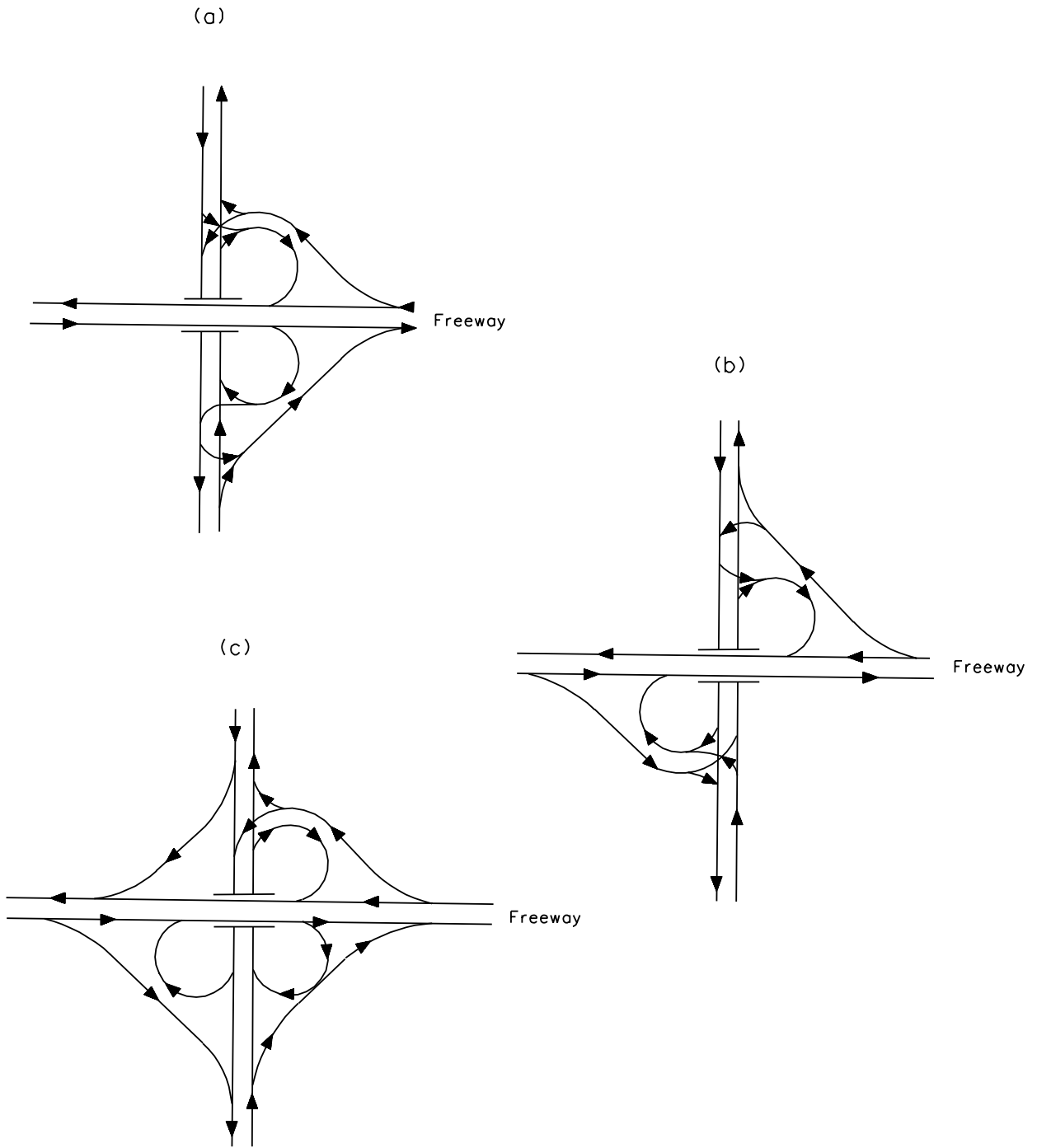

PARTIAL CLOVERLEAF INTERCHANGES

Figure 16.2F

16.2.8 Three-Leg Interchanges

Three-leg interchanges are also known as T- or Y-interchanges. [Figure 16.2G](#) illustrates examples of three-leg interchanges with several methods of providing the turning movements. The trumpet type is shown in [\(a\)](#) where three of the turning movements are accommodated with directional or semi-directional ramps and one movement by a loop ramp. In general, the semi-directional ramp should favor the heavier left-turn movement and the loop the lighter volume. Examples [\(b\)](#) and [\(c\)](#) are options to be considered where right of way is limited and/or design traffic volumes are moderate.

16.2.8.1 T-Type or Trumpet

The most widely used three-leg interchange is the single (or twin) structure trumpet type. See [Figure 16.2G\(a\)](#). The criteria for choosing the orientation of ramps depend on the expected traffic volume or the left-turning movement. The semi-directional ramp (see [Section 16.2.9](#) for a description of semi-directional ramps), sometimes called a “jug handle,” is used when the highest volume is the left-turning movement, and the lesser volume is carried by the lower capacity loop ramp. Semi-directional ramps will handle traffic volumes in the range of 1200 to 1500 vehicles per hour, while loop ramps are limited to 800 to 1200 vehicles per hour. The trumpet interchange is often adaptable to the intersection of a major highway with a principal arterial or freeway.

16.2.8.2 Y-Type (Directional)

The most costly of three-leg interchanges, but highly efficient for traffic operations, is the Y-type. See [Figure 16.2G\(b\)](#) and [\(c\)](#). This type interchange has two or more structures or one three-level structure and provides high-capacity directional traffic movements (approximately 1200 to 1500 vehicles per hour per ramp) without loops. However, the use of this interchange can only be justified by the requirement to provide for directional traffic movements in excess of 800 vehicles per hour. This type of interchange is most common where two major roads join and continue as a single roadway.

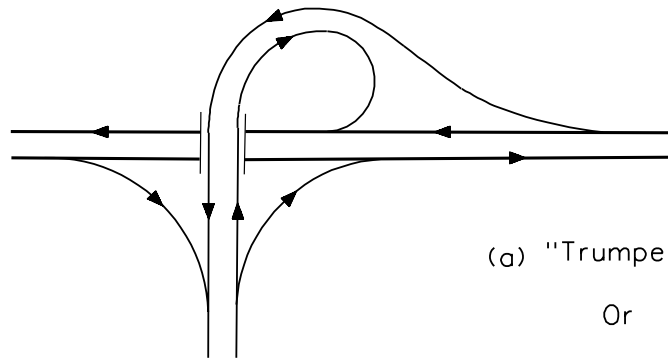

(a) "Trumpet"
Or
"Jug Handle"

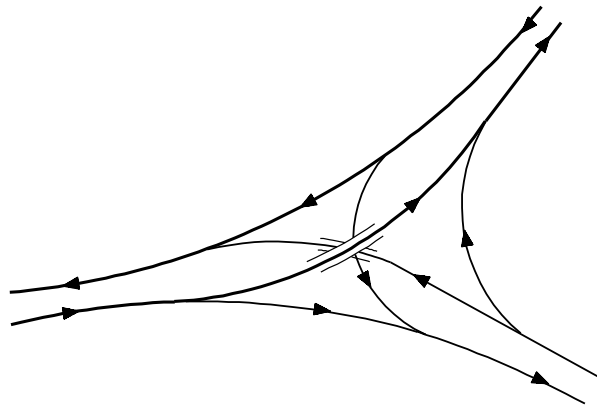

(b) "Y-Type"

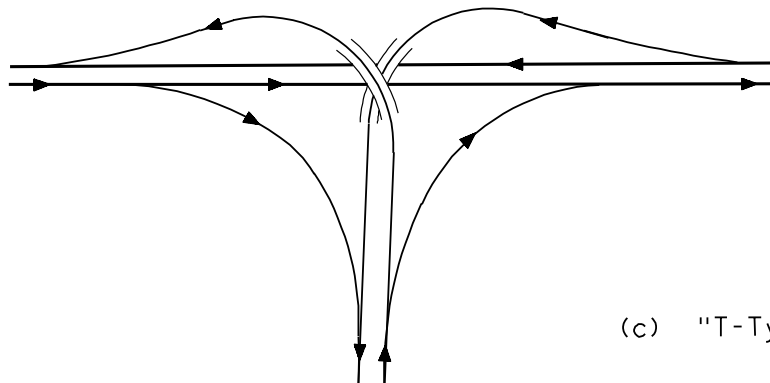

(c) "T-Type"

THREE-LEG INTERCHANGES

Figure 16.2G

16.2.9 Directional and Semi-Directional Interchanges

The following definitions apply to directional and semi-directional interchanges:

1. Fully Directional Interchange — An interchange where all left-turn movements are provided by directional ramps; see [Figure 16.2H](#).
2. Semi-Directional Interchange — An interchange where one or more left-turn movements are provided by semi-directional ramps, even if the minor left-turn movements are accommodated by loops; see [Figure 16.2I](#).
3. Directional Ramp — A ramp that does not deviate greatly from the intended direction of travel; see [Figure 16.2H](#).
4. Semi-Directional Ramp — A ramp that is indirect in alignment, yet more direct than loops, see [Figure 16.2I](#).

Directional or semi-directional ramps are used for heavy left-turn movements to reduce travel distance, to increase travel speed and capacity and to eliminate weaving. These types of connections allow an interchange to operate at a better level of service than is possible with loops. The capacity of a directional or semi-directional ramp is approximately 1200 to 1500 vehicles per hour per ramp lane. Left-hand exits and entrances should be avoided.

Directional or semi-directional interchanges are most often provided in urban or suburban areas at freeway-to-freeway or freeway-to-arterial intersections. In rural areas, there is generally an insufficient traffic volume to justify the use of directional or semi-directional ramps in all quadrants. A directional interchange provides the highest possible capacity and level of service, but it is often costly to construct due to the number of structures required and amount of embankment. Because motorists perceive that higher operating speeds are possible on directional and semi-directional roadways, the alignment of these facilities should be as free flowing as practical.

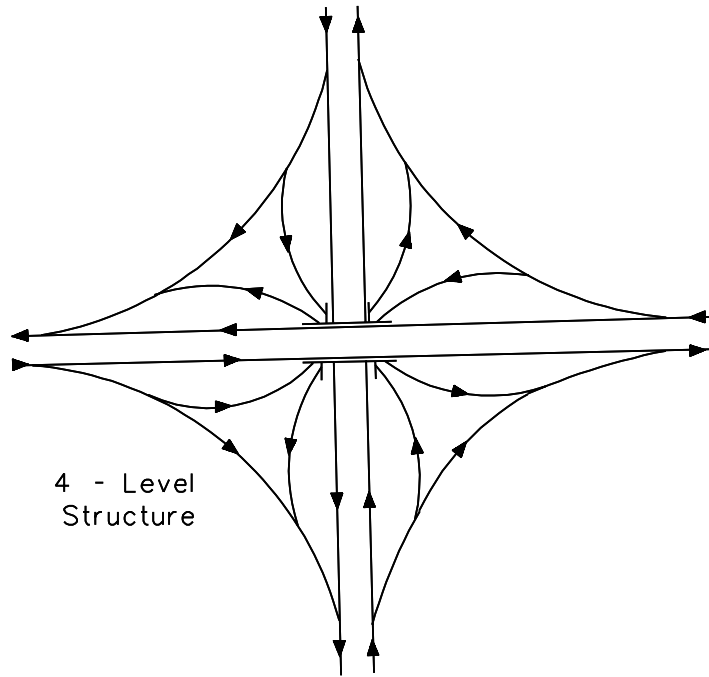

FULLY DIRECTIONAL INTERCHANGE

Figure 16.2H

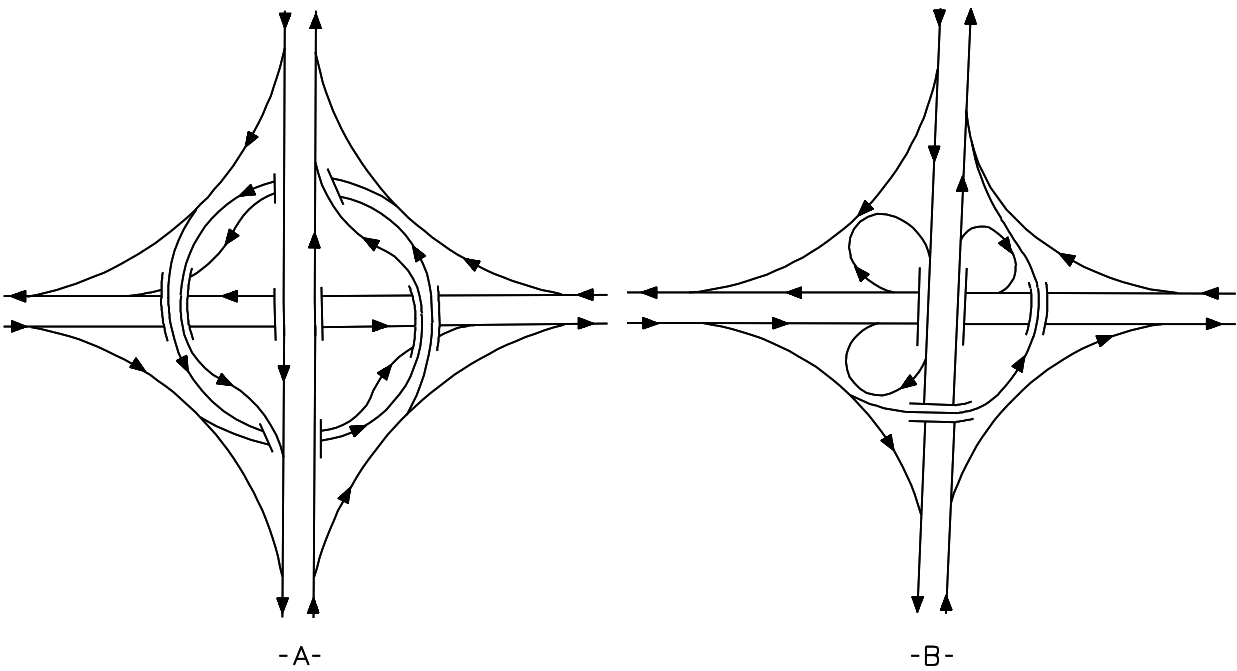

SEMI-DIRECTIONAL INTERCHANGES

Figure 16.2I

16.2.10 Selection

16.2.10.1 Evaluation Factors

The following are some factors that should be evaluated when selecting an interchange type:

- compatibility with the highway system and functional classification of the intersecting highway;
- route continuity and uniformity with adjacent interchanges;
- level of service for each interchange element (e.g., freeway/ramp junction, ramp proper, ramp/crossroad terminal);
- operational and safety considerations (e.g., signing);
- availability of access control along the crossroad;
- road-user impacts (e.g., travel distance and time, convenience, comfort);
- driver expectancy;
- topography and geometric design;
- right of way impacts and availability, construction and maintenance costs and potential for stage construction;
- accommodation of pedestrians and bicyclists on crossroad;
- environmental impacts; and
- potential growth of surrounding area.

16.2.10.2 General Considerations

The designer should consider the following general factors that will influence the selection of an interchange type:

1. Basic Types. A freeway interchange will be one of two basic types. A “systems” interchange will connect a freeway to a freeway; a “service” interchange will connect a freeway to a lesser facility.
2. Freeways. For system interchanges of two fully access-controlled facilities, the minimum design will be a full cloverleaf interchange with collector-distributor roads. Where traffic volumes are significant, a fully or semi-directional interchange may be the most appropriate interchange type.

3. Movements. All interchanges should provide for all movements, even when the anticipated turning volume is low. An omitted maneuver may be a point of confusion to those drivers searching for the exit or entrance. In addition, unanticipated future developments may increase the demand for that maneuver.
4. Capacity. The need for loop ramps or other free-flowing ramps may depend upon the capacity of the ramp termini to adequately accommodate the turning traffic. Conduct a capacity analysis to determine if the ramp termini will be adequate and to determine the appropriate number of approach lanes on the crossroad and ramps.
5. Rural. In rural areas where interchanges occur relatively infrequently, the design can normally be selected strictly on the basis of service demand and analyzed as a separate unit. For most locations, the diamond or partial cloverleaf interchanges are the most appropriate interchange types.
6. Urban. In urban areas the selection of the interchange type is much more complex. In addition to the criteria above, the designer should consider the following factors:
 - a. Right of Way. Right of way, in general, is more restricted in urban areas, thereby limiting the available interchange types. This may eliminate the use of a full cloverleaf. In highly restricted locations, the use of a compressed urban interchange or single-point urban interchange may be the only practical option.
 - b. Spacing. Closely spaced interchanges may be influenced directly by the preceding or following interchange such that additional traffic lanes may be required to satisfy capacity, weaving and lane balance.
 - c. High-Traffic Volumes. Ramps with high volumes may require free-flowing ramp crossroad terminals to adequately accommodate the turning traffic. High-traffic volumes may also cause problems with weaving sections. To accommodate these concerns may require partial cloverleaves.
 - d. Urban System. Evaluate all interchanges along an urban route on a system-wide basis rather than on an individual basis. This will require a corridor analysis reviewing several alternative interchange layouts and types.
 - e. Crossroads. A thorough study of the crossroad is necessary to determine its potential for accommodating the increased volume of traffic that an interchange will discharge. The ability of the crossroad to receive and discharge traffic from the freeway has considerable bearing on the interchange geometrics (e.g., using loops to eliminate left-hand turns from a conventional diamond).

- f. Environmental/Community Factors. Environmental concerns or community opposition to a particular interchange design may impact the selection of an interchange type. For example, a single-point urban interchange or compressed diamond will require less right of way than a partial cloverleaf.

16.2.10.3 Capacity (Traffic Volume) Considerations

Interchange type selection, in part, is based upon providing the capacity and level of service that is consistent with the type of highway (major vs. minor) and the anticipated traffic movement between the two facilities. In the hierarchy of interchanges, diamonds provide the lowest in traffic capacity followed in ascending order by partial cloverleaves, cloverleaves, semi-directionals and directionals. C-D roads can be utilized with all of these interchange types as may be necessary to enhance traffic flow and safety and reduce weaving problems. They are particularly effective in urban freeway design where spacing between interchanges is less than the desired minimum.

[Figure 16.2J](#) may be useful to designers in making preliminary determinations on interchange types for preliminary design purposes. However, [Figure 16.2J](#) should only be a starting point, and detailed individual analyses must be used to make final determinations.

Interchange Location	Type of Intersecting Facility	Total Interchange Volume	Recommended Interchange Type (Preliminary)
Rural	Freeway	Light ($\leq 15,000$ ADT)	Cloverleaf
		Moderate (15,000 to 25,000 ADT)	Cloverleaf with C-D roads to semi-directional
		Heavy ($> 25,000$ ADT)	Semi-directional to full directional
	Major Highway	Light ($\leq 15,000$ ADT)	Diamond
		Moderate (15,000 to 25,000 ADT)	Partial Cloverleaf, Cloverleaf
		Heavy ($> 25,000$ ADT)	Cloverleaf with C-D roads to semi-directional
	Local Road	Light ($\leq 15,000$ ADT)	Diamond
		Moderate (10,000 to 20,000 ADT)	Cloverleaf
		Heavy (N/A)	N/A
Urban	Freeway	Light (N/A)	N/A
		Moderate (20,000 to 35,000 ADT)	Cloverleaf with C-D roads to semi-directional
		Heavy ($> 35,000$ ADT)	Semi-directional to full directional
	Major Highway	Light ($\leq 20,000$ ADT)	Diamond, Split-Diamond
		Moderate (20,000 to 35,000 ADT)	Compressed Diamond, SPUI, partial cloverleaf, cloverleaf
		Heavy ($> 35,000$ ADT)	Cloverleaf with C-D roads to semi-directional
	Local Road	Light ($\leq 15,000$ ADT)	Diamond, Split-Diamond
		Moderate (15,000 to 30,000 ADT)	Compressed Diamond, SPUI, partial cloverleaf
		Heavy ($> 30,000$ ADT)	Cloverleaf with C-D roads

**GENERAL GUIDELINE FOR SELECTION OF INTERCHANGE TYPE
(Based on Traffic Volumes)**

Figure 16.2J

16.2.10.4 Summary

The following presents a summary of the general application of the basic interchange types to general site conditions:

1. Diamond Interchanges. Where left-turning movements are low to and from the major highway, diamond interchanges will normally serve adequately. The capacity of diamond interchanges is limited by the capacity of the at-grade ramp/crossroad intersection. As left-turn movements at diamond interchanges increase, additional lanes and/or traffic signals at one or both ramp/crossroad intersections may be required.
2. Partial Cloverleaf Interchanges. Where one or more left-turn volumes are significant (500 vehicles per hour or more), loop ramp(s) may be added to provide the partial cloverleaf design to allow for continuous flow. Partial cloverleaf interchanges are an effective compromise between diamonds and full cloverleaves. Their usage may be dictated by limited right of way in one or more quadrants or by a need to maintain continuous flow on those left-turn movements that are disproportionately high or by operational limitations of the crossroad that require the elimination of certain crossing maneuvers.
3. Full Cloverleaf Interchanges. Full cloverleaves are the minimum type interchange used at the intersection of two fully access-controlled highways. Limiting factors in the selection of cloverleaf interchanges are the availability of large amounts of right of way (in the vicinity of 20 acres per quadrant) and the capacity for handling weaving at consecutive entrance/exit terminals. Collector-distributor roads may be necessary to eliminate the weaving problems along the mainline roadways.
4. Directional and Semi-Directional Interchanges. Interchanges with direct ramp or semi-direct ramp connections for all left-turning movements are often used at intersections of two high-volume freeways having large and nearly equal traffic volumes interchanging between the two facilities.

16.3 INTERCHANGE SYSTEM OPERATIONS AND DESIGN

Part II and Chapter 19 “Freeways” of the *SCDOT Highway Design Manual* present Department criteria for several operational and geometric design elements (e.g., design speed, horizontal/vertical alignment, cross sections, frontage roads, over/under determinations, freeway lane drops) that apply to an interchange. Section 16.3 discusses operational and design considerations that apply to the overall interchange system and, in many cases, are unique to interchange design.

16.3.1 Interchange Spacing

Interchange spacing is based on the demand for access, adequate distance to provide for signing and weaving and adequate distance to permit the adjacent interchanges to operate safely and efficiently for the appropriate level of service. Locations of adjacent interchanges must be evaluated to meet the appropriate weaving and signing criteria. As a general guide, [Figure 16.3A](#) is provided for initial consideration of interchange spacing.

The desirable values usually allow adequate distances for an entering driver to adjust to the freeway environment, for proper weaving maneuvers between entrance and exit ramps and for adequate signing. However, considering the effects of existing streets and highways, traffic operations and environmental considerations, the spacing between adjacent interchanges may vary considerably. Therefore, the minimum distances in [Figure 16.3A](#) between adjacent interchanges may be necessary for practical application. In urban areas, a spacing of less than 1 mile may be developed by using grade separated ramps and collector-distributor roads.

Location	Spacing (Miles)	
	Desirable	Minimum
Urban	2	1*
Suburban	4	1
Rural	8	2

* *Spacings less than 1 mile may be developed by grade separated ramps or by adding collector-distributor roads.*

PRELIMINARY INTERCHANGE SPACING GUIDE

Figure 16.3A

16.3.2 Distance Between Successive Freeway/Ramp Junctions

Successive freeway/ramp junctions may be placed relatively close to each other, especially in urban areas. The distance between the terminals should provide for vehicular maneuvering, signing and capacity. [Figure 16.3B](#) provides recommended guidelines for spacing distances of various freeway/ramp junctions. The criteria in [Figure 16.3B](#) should be considered for the initial planning stages of interchange location. The final decision on the spacing between freeway/ramp junctions should satisfy the level-of-service criteria. This will be determined by conducting a detailed capacity analysis using the *Highway Capacity Manual*. Where the distance between the tapers of successive entrance and exit terminals is less than 1500 feet, consider connecting the two terminals with an auxiliary lane and provide a recovery area beyond the exit terminal.

16.3.3 Basic Number of Lanes

The basic number of lanes is the minimum number of lanes designated and maintained over a significant length of a route based on the overall operational needs and traffic volumes of that section. The number of lanes should remain constant over short distances. For example, do not drop a lane at the exit of a diamond interchange and then add it at the downstream entrance simply because the through traffic volume decreases between the exit and entrance ramps. Likewise, do not drop a basic lane between closely spaced interchanges simply because the estimated traffic volume does not warrant the higher number of lanes. Lane drops should only occur where there is an overall reduction in the traffic volumes on the freeway route as a whole.

16.3.4 Lane Balance

Lane balance is normally a major concern on high-volume urban freeways and a necessary element to realize efficient traffic operation through an interchange or series of interchanges. After the basic number of lanes is determined, the balance in the number of lanes should be checked on the basis of the following principles:

1. **Exits.** The number of approach lanes to the highway exit should equal the sum of the number of mainline lanes beyond the exit plus the number of exiting lanes minus one; see [Figure 16.3C](#). An exception to this principle would be at cloverleaf loop ramp exits that follow a loop ramp entrance or at exits between closely spaced interchanges (e.g., interchanges where the distance between the taper end of the entrance terminal and the beginning taper of the exit terminal is less than 1500 feet and a continuous auxiliary lane is used between the terminals). In these cases, the auxiliary lane may be dropped at a single-lane exit with the number of lanes on the approach roadway being equal to the number of through lanes beyond the exit plus the lane on the exit.

EN-EN		EX-EX		EX-EN		Directional Ramps		EN-EX (Weaving)			
Full Freeway CDR or FDR		Full Freeway	CDR or FDR	Full Freeway	CDR or FDR	System Interchange	Service Interchange	System to Service Interchange		Service to Service Interchange	
								Full Fwy.	CDR or FDR	Full Fwy.	CDR or FDR
Minimum Lengths (L) Measured Between Successive Ramp Terminals											
300 ft	1000 ft	800 ft	500 ft	400 ft	800 ft	600 ft	2000 ft	1600 ft	1600 ft	1000 ft	1000 ft

FDR - Freeway Distributor Road CDR - Collector-Distributor Road EN - Entrance EX - Exit

Note: The lengths are based on operational experience and the need for flexibility and adequate signing. They should be checked according to the procedure in the Highway Capacity Manual. The larger of the values is suggested for use. Also, a procedure for measuring the length of the weaving section is given in the Highway Capacity Manual.

RAMP TERMINAL SPACING GUIDELINES

Figure 16.3B

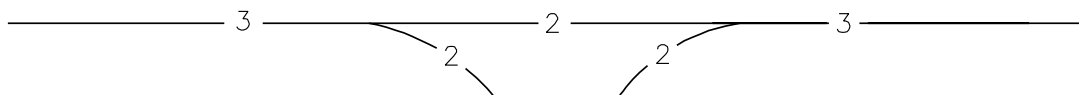

LANE BALANCE BUT NO COMPLIANCE WITH BASIC NUMBER OF LANES

-A-

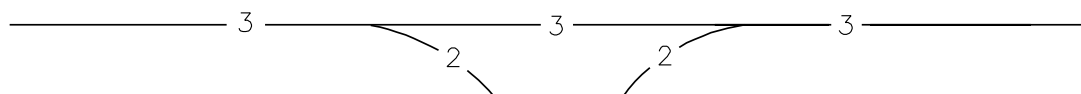

NO LANE BALANCE BUT COMPLIANCE WITH BASIC NUMBER OF LANES

-B-

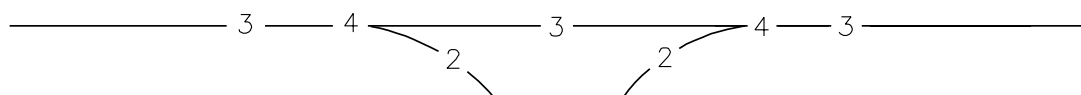

COMPLIANCE WITH BOTH LANE BALANCE AND BASIC NUMBER OF LANES

-C-



Where:

N_C = Number of Lanes for Combined Traffic

N_F = Number of Lanes on Freeway

N_E = Number of Lanes on Exit or Entrance Ramp

LANE BALANCE EQUATIONS

-D-

COORDINATION OF LANE BALANCE AND BASIC NUMBER OF LANES

Figure 16.3C

2. Entrances. At entrances, the number of lanes beyond the merging of the two traffic streams should be not less than the sum of the approaching lanes minus one; see [Figure 16.3C](#).
3. Lane Drops. Reduce the number of travel lanes on the freeway only one lane at a time.

At exits, for example, dropping two mainline lanes at a two-lane exit ramp would violate the principle of lane balance. One lane should provide the option of remaining on the freeway. Lane balance would also prohibit immediately merging both lanes of a two-lane entrance ramp into a highway mainline without the addition of at least one additional lane beyond the entrance ramp. [Figure 16.3C](#) illustrates how to coordinate lane balance and the basic number of lanes at an interchange. [Figure 16.3C](#) also illustrates how to achieve lane balance at the merging and diverging points of branch connections.

16.3.5 Capacity and Level of Service

The capacity of an interchange will depend upon the operation of its individual elements which include:

- basic freeway section where interchanges are not present,
- freeway/ramp junctions,
- weaving areas,
- ramp proper,
- collector-distributor roadways, and
- ramp/crossroad intersections.

The basic capacity reference is the *Highway Capacity Manual* (HCM). The HCM and applicable software provide the analytical tools required to analyze the level of service for each element listed above. The design year for the interchange and crossroad will typically be the same as that for the freeway (i.e., 20 years).

Level of service values presented in [Chapter 19](#) for freeways will also apply to interchanges. The level of service of each interchange element should be equal to the level of service provided on the basic freeway section. Individual elements should not operate at more than one level of service below that of the basic freeway section. In addition, the operation of the ramp/crossroad intersection in urban areas should not impair the operation of the mainline. This will likely involve a consideration of the operational characteristics on the minor road for some distance in either direction from the interchange.

16.3.6 Auxiliary Lanes

As applied to interchange design, auxiliary lanes are most often used to comply with the principle of lane balance, to increase capacity, to accommodate weaving or to accommodate entering and exiting vehicles. The operational efficiency of the freeway may be improved if a continuous auxiliary lane is provided between entrance and exit terminals where interchanges are closely spaced. An auxiliary lane may be dropped at an exit if properly signed and designed. The following statements apply to the use of an auxiliary lane within or between interchanges:

1. Within Interchange. [Figure 16.3D](#) provides the basic schematics of alternative designs for adding and dropping auxiliary lanes within interchanges. The selected design will depend upon traffic volumes for the exiting, entering and through movements.
2. Between Interchanges. Where interchanges are closely spaced, the designer should provide an auxiliary lane where the distance between the end of the entrance terminal and beginning of the exit taper is less than 1500 feet.

Design details for exits and entrances are provided in [Section 16.4](#). Auxiliary lane drops beyond the interchange may be merged approximately 2500 feet beyond the influence of the last interchange. The design details for freeway lane drops are provided in [Section 19.5.1](#).

16.3.7 Weaving Sections

Weaving sections are highway segments where the pattern of traffic entering and exiting at contiguous points of access results in vehicular paths crossing each other. The turbulent effect of weaving operations can result in reduced operating speeds and levels of service for the through traffic. Weaving sections may be eliminated at an interchange between two major highways by using directional or semi-directional connections or by using collector-distributor roadways.

Consider the following for weaving sections:

1. Weave Length. Weaving sections on freeways other than cloverleafs should be at least 1000 feet or the length determined using the *Highway Capacity Manual* (HCM), whichever is greater.
2. Level of Service. The level of service of a weaving section should be the same as that for the adjacent mainline; however, at a minimum, it can be one level lower. A higher volume in weaving sections may be accommodated and their adverse impact on through traffic minimized by providing the weaving section on collector-distributor roadways. [Section 16.3.8](#) discusses the use and design of collector-distributor roadways.

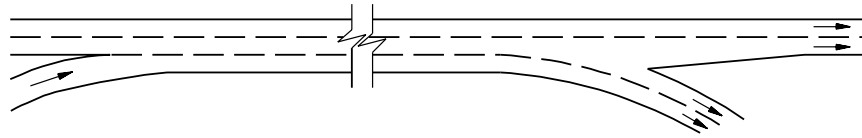

(a) Auxiliary Lane Dropped On Exit Ramp

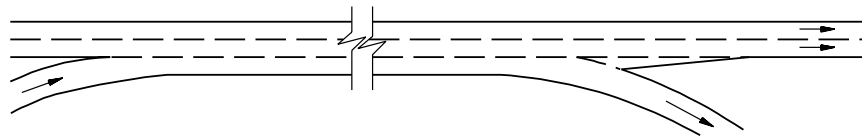

(b) Auxiliary Lane Between Cloverleaf Loops Or Closely Spaced Interchanges Dropped On Single Lane

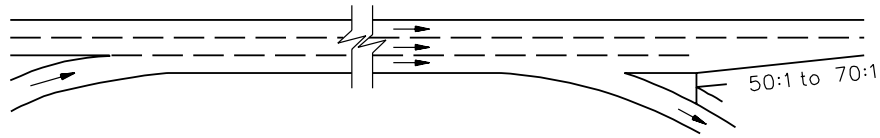

(c) Auxiliary Lane Dropped At Physical Nose

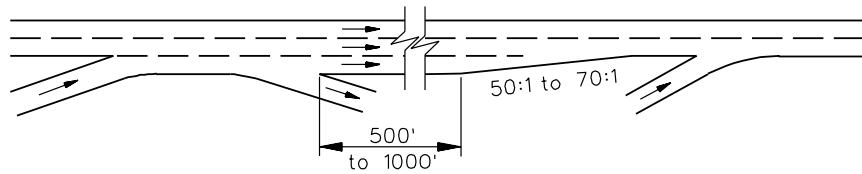

(d) Auxiliary Lane Dropped Within An Interchange

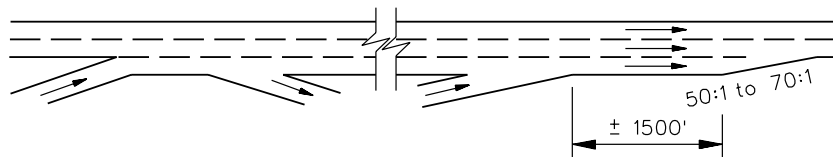

(e) Auxiliary Lane Dropped Beyond An Interchange

AUXILIARY LANES WITHIN AN INTERCHANGE

Figure 16.3D

16.3.8 Collector-Distributor Roadways

16.3.8.1 Usage

A collector-distributor (C-D) roadway is an auxiliary roadway parallel to and separated from the main traveled way that serves to collect and distribute traffic from multiple access points. It provides greater capacity and permits higher operating speeds to be maintained on the main traveled way. C-D roadways may be provided at single interchanges, through two adjacent interchanges or, in urban areas, continuously through several interchanges. [Figure 16.2E](#) illustrates a schematic of a C-D roadway within a full cloverleaf interchange.

Usually, interchanges designed with single exits are superior to those with two exits, especially if one exit is a loop ramp or the second exit is a loop ramp preceded by a loop entrance ramp. Whether used in conjunction with a full cloverleaf or with a partial cloverleaf interchange, the single-exit design may improve the operational efficiency of the entire interchange. C-D roadways use the single exit approach to improve the interchange operational characteristics. C-D roadways will:

- remove weaving maneuvers from the mainline and transfer them to the slower speed C-D roadways,
- provide high-speed single exits and entrances from and onto the mainline,
- satisfy driver expectancy by placing the exit before the grade separation structure,
- simplify signing and the driver decision-making process, and
- provide uniformity of exit patterns.

C-D roadways are most often warranted when traffic volumes (especially in weaving sections) are so high that the interchange cannot operate at an acceptable level of service. They also may be warranted where the speed differential between weaving and non-weaving vehicles is significant.

16.3.8.2 Design

When designing C-D roadways, consider the following:

1. Design Speed. The design speed of a C-D roadway usually ranges from 40 to 65 miles per hour. Typically, use a design speed within 10 miles per hour of the mainline design speed.

2. Lane Balance. Maintain lane balance at the exit and entrance points of the C-D roadways; see [Section 16.3.4](#).
3. Width. C-D roadways may be one or two lanes, depending upon the traffic volumes and weaving conditions. C-D roadways are typically designed similar to ramps with traveled way widths of either 16 feet (1 lane) or 24 feet (2 lanes).
4. Separations. The separation between the C-D roadway and mainline should be as wide as practical. At a minimum, the separation should allow for shoulder widths equal to that on the mainline and for a suitable barrier to prevent indiscriminate crossovers.
5. Terminal Designs. [Section 16.4](#) discusses the design of freeway/ramp junctions. These criteria also apply to C-D roadway/ramp junctions.

16.3.9 Route Continuity

The major route should flow continuously through an interchange. For freeway and expressway routes that change direction, the driver should not be required to change lanes or exit to remain on the major route. Route continuity without a change in the basic number of lanes is consistent with driver expectancy, simplifies signing and reduces the decision demands on the driver. Interchange configurations should not necessarily favor the heavier traffic movement. There may occasionally be sites where it is advisable to design the interchange to provide route continuity despite the traffic volume movements.

16.3.10 Uniformity

Interchange configurations along a route should be uniform from one interchange to another. All ramps should exit and enter on the right except under highly unusual conditions. Dissimilar arrangements between interchanges can cause confusion resulting in undesirable lane switches, reduced speeds, etc., especially in urban areas where interchanges are closely spaced.

16.3.11 Left-Hand Ramps

Where practical, avoid the use of left-hand exit and entrance ramps. They are less efficient operationally than right-hand ramps, and they can introduce an undesirable element of non-uniformity into the design of a freeway system that can lead to confusion and, in some cases, hazardous behavior by drivers.

16.3.12 Signing and Marking

Proper interchange operations depend on the compatibility between its geometric design and the traffic control devices at the interchange. The proper application of signs and pavement markings will increase the clarity of paths to be followed, safety and operational efficiency. The logistics of signing along a highway segment will also influence the minimum acceptable spacing between adjacent interchanges. The *MUTCD* provides guidelines and criteria for the placement of traffic control devices at interchanges.

16.3.13 Ramp Metering

Ramp metering may be used to improve freeway operations. Ramp metering consists of traffic signals installed on entrance ramps before the entrance terminal to control the number of vehicles entering the freeway. The Traffic Engineering Division will determine the need for ramp metering. If used, the designer will need to coordinate with the Traffic Engineering Division to determine the placement of the ramp signal to insure that there is a sufficient storage area before the ramp signal and that sufficient acceleration distance is available beyond the signal to allow a vehicle to reach freeway speed.

16.3.14 Grading and Landscaping

Consider the grading around an interchange early in the design process. Alignment, fill-and-cut sections, median widths, lane widths, drainage, structural design and infield contour grading all affect the aesthetics of the interchange. Properly graded interchanges allow the overpassing structure to blend naturally into the terrain. In addition, insure that the crossroad and ramp slopes are not so steep that they compromise safety and they can support plantings to prevent erosion and enhance the appearance of the area. Flatter slopes also allow easier maintenance. Transitional grading between cut-and-fill slopes should be long and natural in appearance. The designer must insure that plantings will not affect the sight distance within the interchange and that larger plantings are a significant distance from the traveled way.

Include a contour grade detail for interchanges in the Plans.

16.3.15 Operational/Safety Considerations

Operations and safety are important considerations in interchange design. The following summarizes several general factors:

1. Exit Ramps. For exit ramps, consider the following:

- a. Signing. Proper advance signing of exits is essential to allow necessary lane changes before the exit.
 - b. Deceleration. Provide sufficient distance to allow safe deceleration from the freeway design speed to the design speed of the first governing geometric feature on the ramp, typically a horizontal curve.
2. Entrance Ramps. Provide an acceleration distance of sufficient length to allow a vehicle to attain an appropriate speed for merging. Where entrance ramps enter the mainline on an upgrade, the acceleration distance may need to be lengthened, or an auxiliary lane may be required to allow vehicles to reach a safe speed prior to merging.
3. Driver Expectancy. Insure that the interchange is designed to conform to the principles of driver expectancy. These may include the following:
 - a. Left-Hand Exits and Entrances. Avoid left-hand exit or entrance terminals. Drivers expect single-lane exit and entrance terminals to be located on the right side of the freeway.
 - b. Horizontal Alignment. Do not locate exit ramps so that it gives the appearance of a continuing mainline tangent as the mainline curves to the left.
 - c. Consistency. Do not mix operational patterns between interchanges, lane continuity or interchange types.
 - d. Lane Balance. Provide lane balance and the basic number of lanes on the freeway.
 - e. Spacing. Provide sufficient spacing between interchanges to allow proper signing distances to decision points.
4. Roadside Safety. Because of the typical design features at interchanges, many fixed objects may be located within interchanges (e.g., signs at exit gores, bridge piers, rails). Avoid locating these objects near decision points, make them breakaway or shield them with barriers or impact attenuators. See [Chapter 14](#) for detailed guidance on roadside safety.
5. Traffic-Controlled Ramp Terminals. The designer must insure that ramp/crossroad intersections have sufficient capacity so that the queuing traffic at the crossroad intersection does not backup onto the freeway. Also, sufficient access control and intersection sight distance must be maintained along the crossroad to allow the ramp intersection to work properly. Provide sufficient sight distance to the ramp/crossroad traffic control devices.

6. Wrong-Way Maneuvers. Provide channelized medians, islands and/or adequate signing to minimize wrong-way possibilities. Avoid designs that may result in poor visibility, confusing ramp arrangements or inadequate signing.
7. Pedestrians and Bicyclists. Use signing and lane markings to increase awareness of pedestrians and bicyclists. Signing, crosswalks, barriers, over and underpasses, bridge sidewalks and other traffic control devices may be required to manage traffic movements and to control pedestrian and bicycle movements.

16.3.16 Geometric Design Criteria

Design all roadways through an interchange with the same criteria as used for the approaches including design speed, sight distance, horizontal and vertical alignment, cross section and roadside safety elements. In addition, consider the following:

1. Design Year. Typically, use a 20-year design period based on the anticipated opening date of the facility.
2. Design Speed (Crossroad). The crossroad design speed should be based on its functional classification and its urban or rural classification; see the geometric design tables in Part III "Design of Functional Classes."
3. Horizontal Alignment. In general, design the alignment of the freeway and crossroad through the interchange on a tangent. Where this is not practical, consider the following:
 - a. Freeway Mainline. Minimize locating exit terminals where the freeway mainline curves to the left. If it cannot be avoided, provide an abrupt exit taper.
 - b. Freeway/Ramp Junctions. Design the freeway alignment so that only one exit terminal departs from the mainline curving to the right, or design the mainline curve to lie entirely within the limits of the interchange and away from the exit and entrance terminals.
 - c. Superelevation. Desirably, design the horizontal alignment so that superelevation and superelevation transitions will not be required through the freeway/ramp junctions or through the ramp/crossroad intersection.
 - d. Crossroad. Where a curve is necessary, provide a significantly large horizontal curve so that superelevation is not required on the crossroad, if practical.
4. Vertical Alignment. Vertical profiles for both roadways through the interchange should be as flat as practical. Where compromises are necessary, use the flatter

grade on the major facility. In addition, the designer should consider the following:

- a. Sight Distance. To improve the sight distance to exit gores, locate exit ramp terminals and major divergences where the mainline is on an upgrade.
 - b. Ramps. Ramps should depart from the mainline where there will be no vertical curvature to restrict visibility along the ramp. Avoid ramp designs that drop out of sight. Also, provide flat approach grades adjacent to the crossroad. For additional information on storage platforms at the ramp/crossroad intersection, see [Section 15.2](#).
 - c. Exit Ramp Terminals. Where a freeway is proposed to cross over the crossroad, locate the exit ramp terminals on the mainline no closer than 1000 feet from the high point of a crest vertical curve on the mainline. This will insure that no hidden ramps exist and will provide for safer operations at the exit ramp terminal.
 - d. Turning Trucks. Large trucks may become unstable when executing a nonstop, left turn from a crossroad on a downgrade. The combination of a downgrade, sharp turning maneuvers onto a ramp and reverse superelevation may produce instability in large trucks. Therefore, the maximum grade for all crossroads associated with these conditions is desirably 2 percent through the ramp/crossroad terminal. For existing crossroads to remain in place, limit the downgrade to 3 percent. At a maximum, limit the up and downgrades to 4 percent.
5. Sight Distance. Because of the additional demand placed on the driver at an interchange, the designer should consider the following sight distance elements:
- a. Stopping Sight Distance. Provide adequate stopping sight distance on both intersecting highways throughout the interchange and on all ramps. Check both the vertical and horizontal alignment to insure that the location of piers, abutments, structures, bridge rails, vertical curves, etc., will not restrict sight distance. [Chapter 11](#) discusses the application of horizontal sight distance. [Chapter 12](#) discusses the application of vertical sight distance.
 - b. Decision Sight Distance. Desirably, provide decision sight distance to all decision points (e.g., exit and entrance terminals); see [Chapter 10](#). Desirably, at exit ramps, use the pavement surface for the height of object (i.e., 0.0 inches). Driver expectancy should not be violated.

- c. Intersection Sight Distance. Section 10.4 discusses intersection sight distance (ISD), which is also applicable at ramp/crossroad intersections (non-merging sites). Section 16.6 provides additional ISD guidance that should be considered at ramp/crossroad intersections that are stop controlled.
6. Ramp/Crossroad Intersections. When designing the ramp/crossroad intersection, consider the following:
 - a. Angle of Ramp Intersection. To determine the appropriate angle for the ramp/crossroad intersection, see Section 15.2.6.
 - b. Access Control. To determine the required length of access control along the crossroad at the interchange, see Section 9.8.
 - c. Left-Turn Lanes. Select the appropriate left-turn lane lengths based on the design speed of the crossroad and/or the required storage lengths; see Section 15.5.
 - d. Turning Movements. Check the ramp/crossroad intersection with the applicable design vehicle turning template or use a computer-simulated turning template program. As discussed in Section 16.6, use the WB-62 design vehicle at all ramp/crossroad intersections.
7. Mainline/Crossroad Point of Intersection. Once Items 1 through 6 above have been determined, the designer must decide where the mainline alignment best intersects with the crossroad. The overall size of the interchange, crossroad gradelines, required length of access control along the crossroad, access to property at the ends of access control on the crossroad, and topography are the most influential factors in this determination. Complete this investigation before the detailed design of an interchange is initiated.

16.3.17 Reviewing for Ease of Operation

The designer should review the proposed design from the driver's perspective. This involves tracing all possible movements that an unfamiliar motorist would drive through the interchange. Review the Plans for areas of possible confusion, proper signing and ease of operation and to determine if sufficient weaving distance and sight distances are available. Review both day and nighttime operations. Consider the peak-hour volumes, number of traffic lanes, etc. to determine the type of traffic the driver may encounter.

16.4 FREEWAY/RAMP JUNCTIONS

16.4.1 Exit Ramps

16.4.1.1 Types of Exit Ramps

There are two basic types of exit freeway/ramp junctions — the taper design and the parallel design. [Figures 16.4A](#) and [16.4B](#) illustrate these designs. For most new and reconstructed ramps, SCDOT preference is to use the taper design. However, the designer may consider using the parallel design where:

- a ramp exit is just beyond a structure and there is insufficient sight distance available to the ramp gore;
- the need is satisfied for a continuous auxiliary lane (see [Section 16.3.6](#));
- the geometrics of the exit ramp are such that the taper design cannot satisfy the length needed for deceleration; or
- the exit ramp departs from a horizontal curve on the mainline. In this case, the parallel design is less confusing to through traffic and will normally result in smoother operation. It is also easier to design the superelevation transition with a parallel design.

16.4.1.2 Taper Rates

The taper rate applies to the rate at which the ramp diverges from the mainline. The following taper rates apply:

1. Taper Exit Design. The taper angle can vary between 2 and 5 degrees. For the typical SCDOT ramp design, the divergence angle is 4 degrees as illustrated in [Figure 16.4A](#).
2. Parallel Exit Design. The taper rate applies to the beginning of the parallel lane. This distance is typically 300 feet (i.e., 25:1) as illustrated in [Figure 16.4B](#).

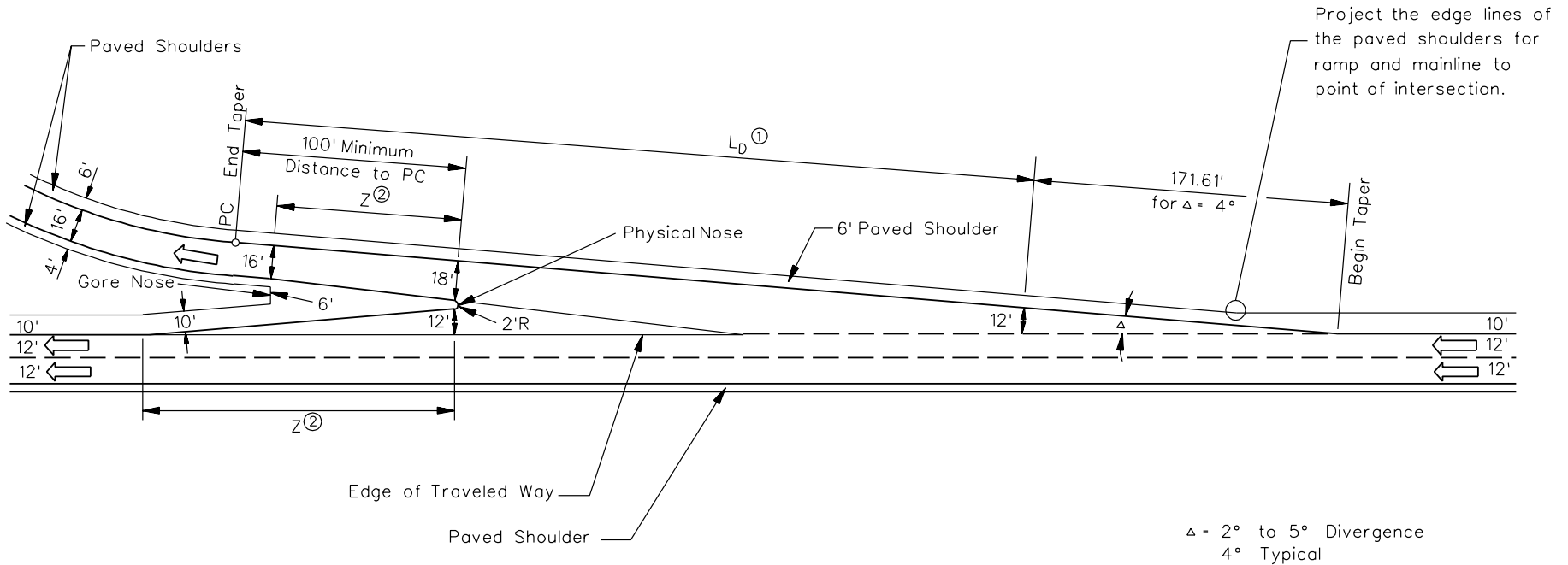

Note: ① L_D is the deceleration distance required for a vehicle to slow down from the mainline design speed to the design speed of the first geometric control on the ramp; see [Section 16.4.1.3](#).

② See [Figure 16.4F](#) for the taper rate to transition the offset physical nose to the normal traveled way width.

TAPER EXIT RAMP

Figure 16.4A

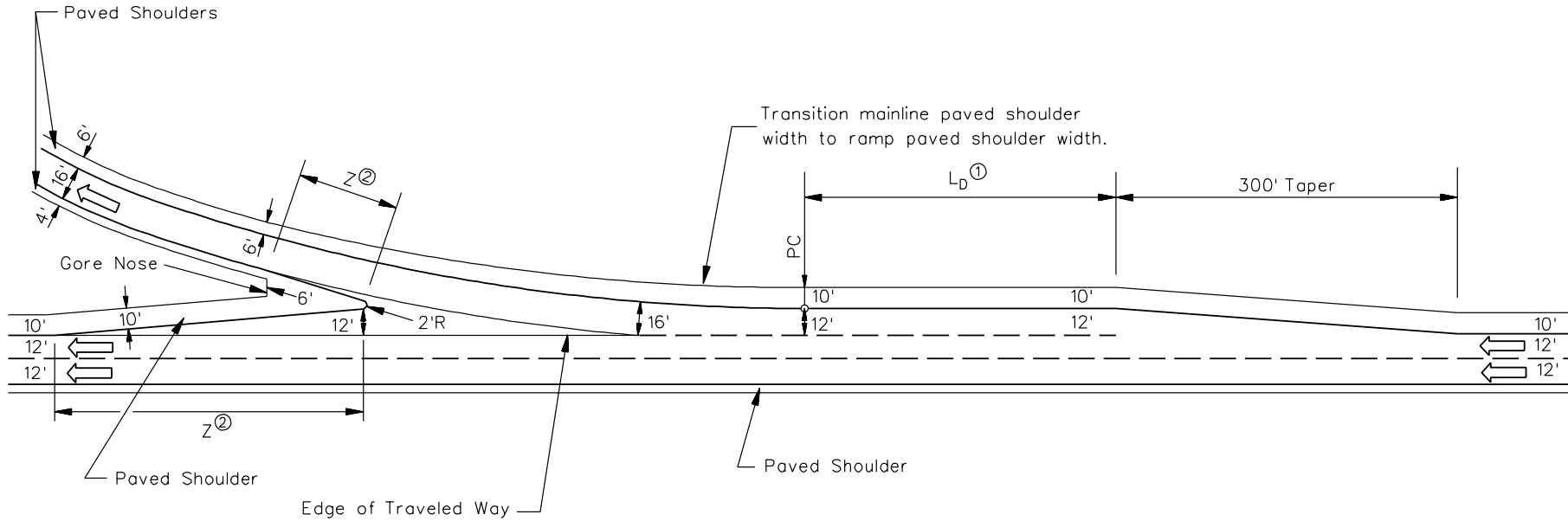

Note: ① L_D is the deceleration distance required for a vehicle to slow down from the mainline design speed to the design speed of the first geometric control on the ramp; see [Section 16.4.1.3](#).

② See [Figure 16.4F](#) for the taper rate to transition the offset physical nose to the normal traveled way width.

PARALLEL-LANE EXIT RAMP

Figure 16.4B

16.4.1.3 Deceleration

Sufficient deceleration is needed to safely and comfortably allow an exiting vehicle to depart from the mainline. The following will apply:

1. Taper Exit. All deceleration should occur within the full width of the deceleration lane. The length of deceleration will depend upon the design speed of the mainline and design speed of the first governing geometric control on the ramp, typically a horizontal curve. This distance is measured from where the ramp becomes 12 feet wide to the first geometric control.
2. Parallel-Lane Exit. The departure curve or taper should be designed based on the design speed of the roadway being departed. The deceleration length begins where the full width of the parallel lane becomes available and ends where the departure curve of the ramp begins, see [Figure 16.4B](#).

[Figure 16.4C](#) provides the deceleration distances for various combinations of highway design speeds and ramp design speeds. If the deceleration distance is on a downgrade of 3 percent or more, adjust the deceleration distance according to the criteria in [Figure 16.4D](#).

* * * * *

Example 16.4(1)

Given: Highway Design Speed = 70 miles per hour
 First Exit Curve Design Speed = 45 miles per hour
 Average Grade = 5 percent downgrade

Problem: Determine length of deceleration required.

Solution: [Figure 16.4C](#) yields a minimum deceleration length of 390 feet on the level. According to [Figure 16.4D](#), this should be increased by 1.35.

$$\begin{aligned} \text{Therefore: } L_D &= (390)(1.35) \\ L_D &= 527 \text{ feet} \end{aligned}$$

Provide a 527-foot deceleration length from the full width of the exit lane to the PC of the first exit curve.

* * * * *

Design Speed of Highway (mph)	Speed Reached (mph)	$L_D =$ Length of Deceleration (ft)								
		For Design Speed of First Governing Geometric Control (mph)								
		Stop	15	20	25	30	35	40	45	50
		For Average Running Speed (mph) (V'_a)								
		0	14	18	22	26	30	36	40	44
30	28	235	200	170	140	—	—	—	—	—
35	32	280	250	210	185	150	—	—	—	—
40	36	320	295	265	235	185	155	—	—	—
45	40	385	350	325	295	250	220	—	—	—
50	44	435	405	385	355	315	285	225	175	—
55	48	480	455	440	410	380	350	285	235	—
60	52	530	500	480	460	430	405	350	300	240
65	55	570	540	520	500	470	440	390	340	280
70	58	615	590	570	550	520	490	440	390	340
75	61	660	635	620	600	575	535	490	440	390

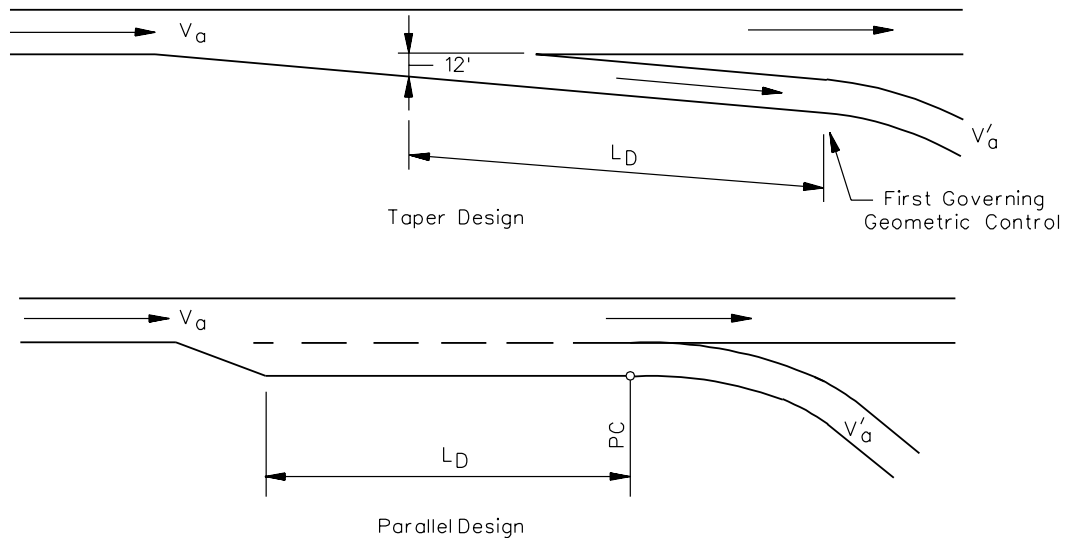

Notes:

1. The deceleration lengths are calculated from the distance needed for a passenger car to decelerate from the average running speed of the highway mainline to the average running speed of the first governing geometric control.
2. These values are for grades less than 3 percent. See [Figure 16.4D](#) for steeper downgrades.
3. Select the actual design speed of the mainline and ramp when using this Figure.

LENGTH FOR DECELERATION

Figure 16.4C

Direction of Grade	Ratio of Deceleration Length on Grade (G) to Length on Level		
	$G < 3\%$	$3\% \leq G < 5\%$	$5\% \leq G < 6\%$
Downgrade	1.0	1.2	1.35
Upgrade	1.0	0.9	0.8

- Notes:
1. Figure applies to all highway design speeds.
 2. The "grade" in the table is the average grade over the distance used for measuring the length of deceleration. See [Figures 16.4A and 16.4B](#).

GRADE ADJUSTMENTS FOR DECELERATION LENGTHS

Figure 16.4D

16.4.1.4 Sight Distance

Desirably, provide decision sight distance approaching a freeway exit. At a minimum, this sight distance should exceed the stopping sight distance by 25 percent. This sight distance should be available throughout the freeway/ramp junction (e.g., from the beginning taper to the gore nose; see [Figures 16.4A and 16.4B](#)). This sight distance is particularly important for exit loops immediately beyond a structure. Vertical curvature or bridge piers can obstruct the exit points if not carefully designed. The desirable height of object will be 0.0 feet (the roadway surface); however, it is acceptable to use 2 feet.

16.4.1.5 Horizontal Alignment

Superelevation for horizontal curves at the freeway/ramp junction will be developed based on the principles of superelevation as discussed in [Section 11.3](#) for mainline highways. In addition, the following criteria are applicable to superelevation development at freeway exits:

1. Design Speed. Desirably, the design speed of the mainline roadway will be used as the design speed for any horizontal curves at the freeway/ramp exit. As discussed in [Section 16.4.1.3](#), the freeway/ramp exit should provide sufficient distance for a vehicle to decelerate from the mainline design speed to the design speed of the first controlling design element of the exit ramp. This could be a horizontal curve in the vicinity of the exit gore. If the necessary deceleration distance is available, the design speed of the horizontal curve at a minimum may be equal to the design speed of the ramp proper; see [Section 16.5](#).

2. Maximum Superelevation. The e_{\max} that is applicable to the mainline (see [Section 11.3](#)) will also apply to horizontal curves at the freeway/ramp exit. In most cases, this will be $e_{\max} = 8.0$ percent.
3. Superelevation Rate. Use the applicable e_{\max} figure in [Section 11.3](#) to determine the proper superelevation rate for horizontal curves at freeway/ramp exits. The designer will use the selected design speed and the curve radius to read into the tables to determine “e.”
4. Transition Length. The designer must transition the exit ramp cross slope on tangent (typically 2.08 percent) to the superelevation rate for the horizontal curve. The following applies:
 - a. The transition should not begin until the exit ramp has reached a minimum 12-foot width.
 - b. The maximum relative longitudinal gradient should not exceed the criteria in [Figure 11.3A](#). The relative gradient is measured between the outside edge of ramp traveled way and the inside edge of ramp traveled way.
 - c. The minimum transition length should be based on the principles and criteria in [Section 11.3.2](#).
 - d. If practical, approximately 67 percent of the transition length should be on the tangent and approximately 33 percent on the curve.
5. Point of Revolution. The designer may choose to put the point of revolution on either the inside or outside of the ramp traveled way.

16.4.1.6 Cross Slope Rollover

The cross slope rollover is the algebraic difference between the transverse slope of the through lane and the transverse slope of the exit lane and/or gore. The following will apply:

1. Up to Physical Nose. The cross slope rollover should not exceed a range of 4 to 5 percent.
2. From Physical Nose to Gore Nose. The cross slope rollover should not exceed 7 percent.
3. Drainage Inlets. Where required, these are normally placed between the physical gore and gore nose. The presence of drainage inlets may require two breaks in the gore cross slope. These breaks should meet the criteria in Items 1 or 2 above, depending on the inlet location.

See [Section 16.4.1.8](#) for gore nose definitions.

16.4.1.7 Shoulders

The wider right shoulder of the mainline must be transitioned to the narrower shoulder of the ramp (i.e., 10 foot paved to 6 foot paved). The shoulder width should be transitioned as shown in [Figures 16.4A](#) and [16.4B](#).

16.4.1.8 Gore Area

The gore area is normally considered to be both the paved triangular area between the through lane and the exit ramp, plus the graded area that may extend a few hundred feet downstream beyond the gore nose. See the *SCDOT Standard Drawings*. The following definitions will apply (see [Figure 16.4E](#)):

1. Painted Nose. This is the point (without width) where the pavement striping on the left side of the ramp converges with the stripe on the right side of the mainline traveled way.
2. Physical Nose. This is the point where the ramp and mainline shoulders converge. As illustrated in [Figure 16.4E](#), the physical nose is rounded with a 2-foot radius.
3. Gore Nose. This is the point where the paved shoulder ends and the grassed area begins as the ramp and mainline diverge from one another, as illustrated in [Figure 16.4E](#).

Consider following when designing the gore:

1. Obstacles. If practical, the area beyond the gore nose should desirably be free of all obstacles (except the ramp exit sign) for at least 100 feet beyond the gore nose. Any obstacles within approximately 300 feet of the gore nose must be made breakaway or shielded by a barrier.
2. Transitions. [Figure 16.4F](#) provides the minimum taper rates (z) that should be used to transition the physical nose offset to the normal traveled way width.
3. Side Slopes. The graded area beyond the gore nose should be as flat as practical. If the elevation between the exit ramp or loop and the mainline increases rapidly, this may not be practical. These areas will likely be non-traversable, and the gore design must shield the motorist from these areas. At some sites, the vertical divergence of the ramp and mainline will warrant protection for both roadways beyond the gore; see [Chapter 14](#).

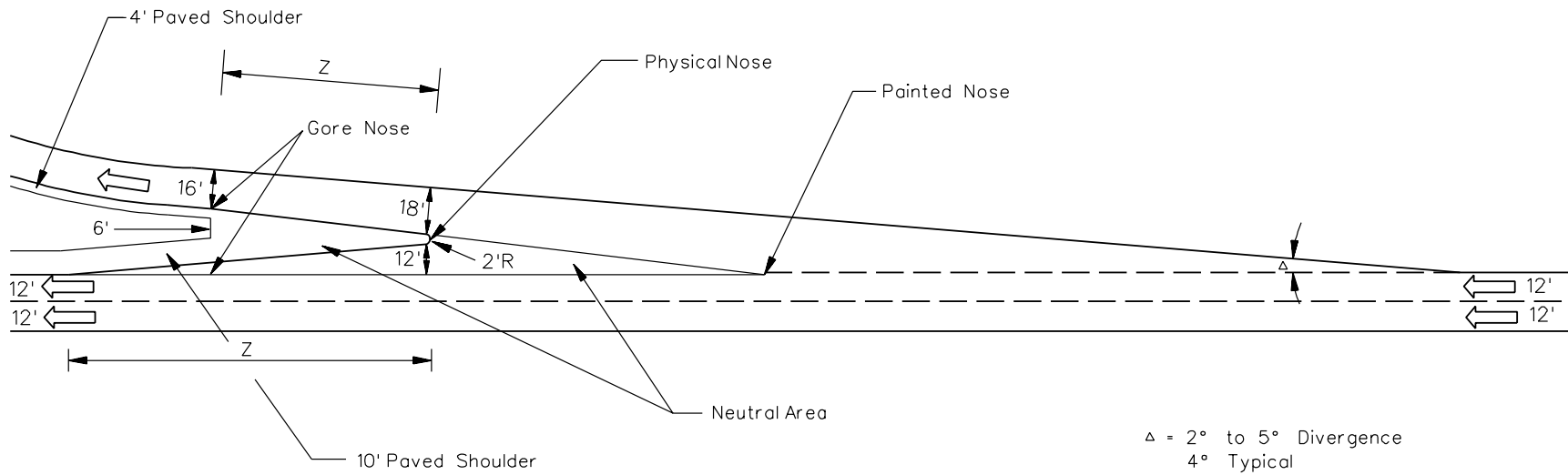

GORE AREA CHARACTERISTICS

Figure 16.4E

Design Speed of Approach Highway (mph)	Taper Rate (z) for Offset Nose
40	20:1
45	22.5:1
50	25:1
55	27.5:1
60	30:1
65	32.5:1
70	35:1
75	37:1

MINIMUM TAPER RATES BEYOND THE OFFSET PHYSICAL NOSE

Figure 16.4F

4. Cross Slopes. The paved triangular gore or neutral area between the through lane and exit ramp should be safely traversable. The cross slope is the same as that of the mainline (typically 2.08 percent) from the painted nose up to the physical nose. Beyond this point, the gore area is depressed with cross slopes of 2 to 4 percent. See [Section 16.4.1.6](#) for criteria on breaks in cross slopes within the gore area.
5. Recovery Area. Where crash history indicates a problem or where it may be confusing for the exiting or through driver, the designer may consider providing a recovery area for 500 to 1000 feet beyond the gore nose.

16.4.2 Entrance Ramps

16.4.2.1 Types

There are two basic types of entrance freeway/ramp junctions — the taper design and the parallel design; see [Figures 16.4G](#) and [16.4H](#). For most entrance ramps, the parallel design is preferred considering the following:

1. Level of Service. Where the level of service for the freeway/ramp merge approaches capacity, a parallel design can be lengthened to allow the driver more time and distance to merge into the through traffic.
2. Acceleration Length. The acceleration length can be more easily provided by the parallel design than the taper design.
3. Sight Distance. Where there is insufficient sight distance available for the driver to merge into the mainline (e.g., where there are sharp curves on the mainline), the parallel entrance ramp allows a driver to use the side-view and rear-view mirrors to more effectively locate gaps in the mainline traffic.

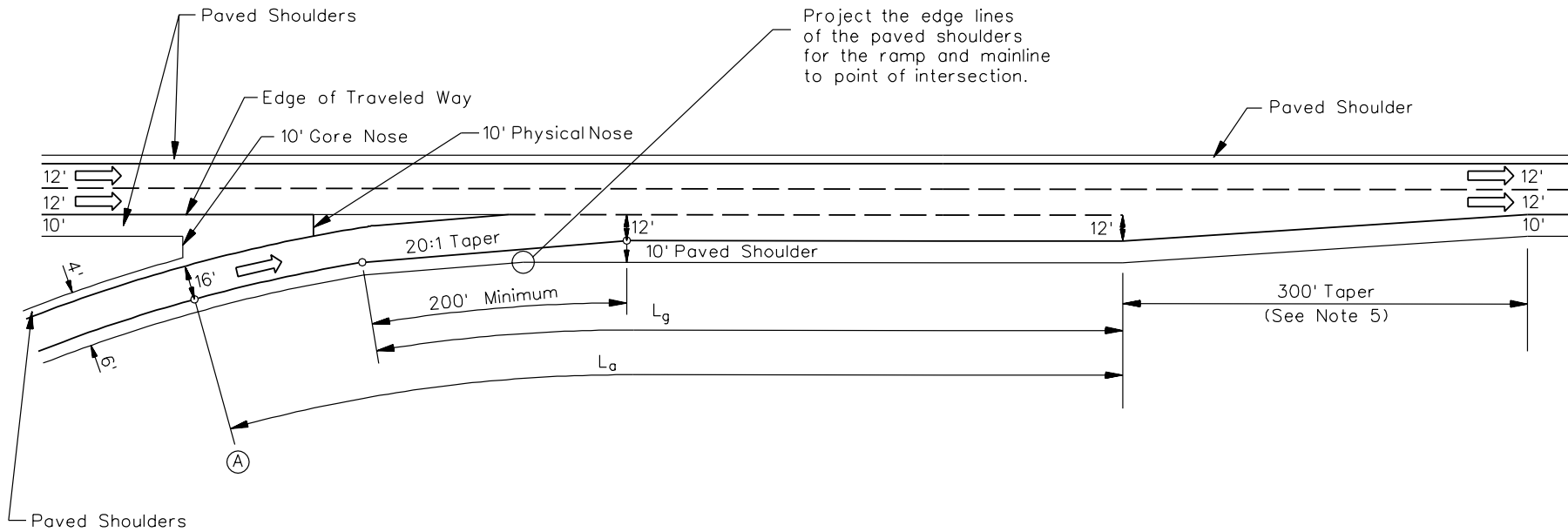

Notes:

1. L_a is the required acceleration length; see Section 16.4.2.3.
2. Point A controls the safe speed on the ramp L_a should not start on the curvature of the ramp unless the ramp radius is ≥ 1000 feet.
3. L_g is the required gap acceptance length. L_g should be a minimum of 300 feet.
4. Use the greater distance of L_a or L_g for determining the ramp entrance length.
5. The taper rate should be 50:1 to 70:1 if L_g is 2500 feet or greater; see Section 19.5.1.

PARALLEL-LANE ENTRANCE RAMP

Figure 16.4G

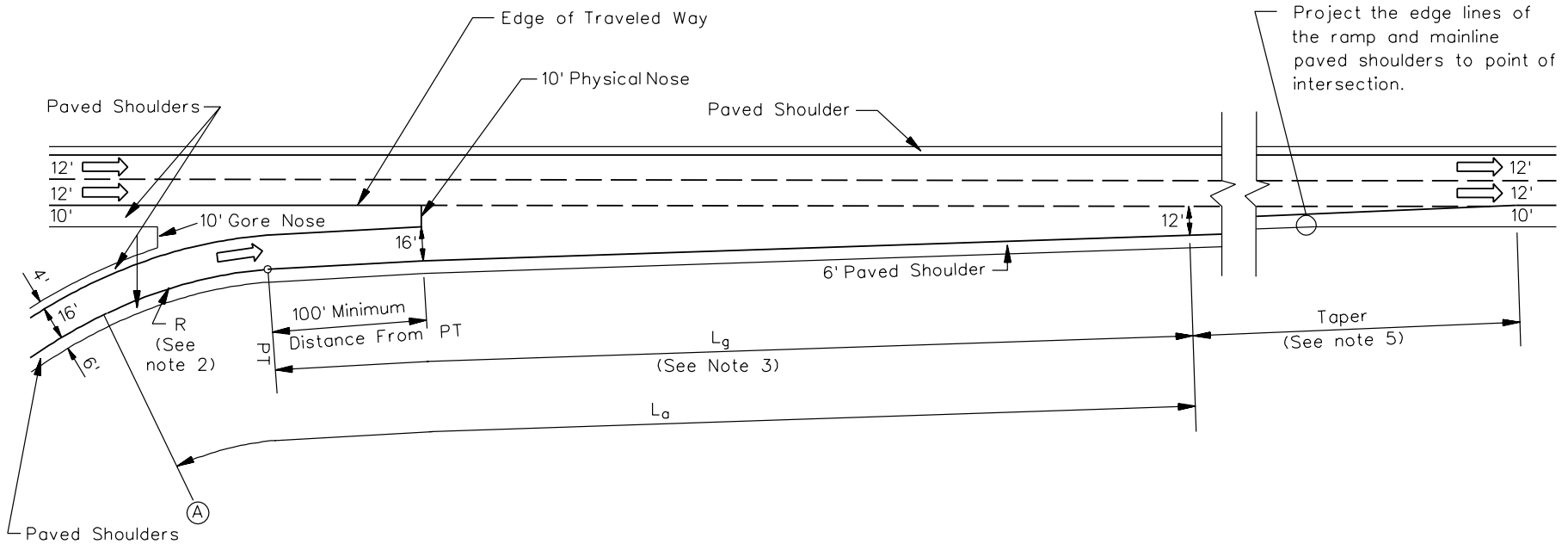

Notes:

1. L_a is the required acceleration length; see Section 16.4.2.3.
2. Point (A) controls the safe speed on the ramp. L_a should not start on the curvature of the ramp unless the ramp radius is ≥ 1000 feet.
3. L_g is the required gap acceptance length. L_g should be a minimum of 300 feet to 500 feet from the 10-foot nose width.
4. Use the greater distance of L_a or L_g for determining the ramp entrance length.
5. The transition taper rate of 50:1 to 70:1 is provided from the PT to the end of the taper.

TAPER ENTRANCE RAMP**Figure 16.4H**

16.4.2.2 Taper Rates

The following taper rates apply to the entrance design:

1. Parallel Design. For parallel-lane entrance ramps, the taper applies to the merge point at the end of the parallel portion of the ramp. The minimum distance is 300 feet (i.e., 25:1) as illustrated in [Figure 16.4G](#).
2. Taper Design. This rate applies to the rate at which the ramp connects with the mainline. The rate should be between 50:1 (minimum) and 70:1 (desirable) for merges onto a major highway and 25:1 for merges onto a crossroad. See [Figure 16.4H](#).

16.4.2.3 Acceleration

Driver comfort, traffic operations and safety will be improved if sufficient distance is available for acceleration. The length for acceleration will primarily depend upon the design speed of the last controlling horizontal curve on the entrance ramp and the design speed of the mainline. When determining the acceleration length, the designer should consider the following:

1. Passenger Cars. [Figure 16.4I](#) provides the minimum lengths of acceleration for passenger cars. The acceleration distance is measured from the PT of the last controlling horizontal curve to the point at which the acceleration lane becomes less than 12 feet in width; see [Figures 16.4G](#) and [16.4H](#). Also, see Item 3 to determine how the horizontal curve interrelates with determining the acceleration distance. Where upgrades exceed 3 percent over the acceleration distance, adjust the acceleration length according to the values presented in [Figure 16.4J](#).

The acceleration lengths provide sufficient distance for the acceleration of passenger cars. Where the mainline and ramp will carry traffic volumes approaching the design capacity of the merging area, the available acceleration distance should be at least 1200 feet, exclusive of the taper, to provide additional merging opportunities. This distance is measured from the PT of the ramp entrance curve.

Design Speed of Highway (mph)	Speed Reached at End of Full Lane Width (mph) (V_a)	L_a = Length of Acceleration (ft)								
		For Entrance Curve Design Speed (mph)								
		Stop	15	20	25	30	35	40	45	50
		For Average Running Speed (mph) (V'_a)								
		0	14	18	22	26	30	36	40	44
30	23	180	140	—	—	—	—	—	—	—
35	27	280	220	160	—	—	—	—	—	—
40	31	360	300	270	210	120	—	—	—	—
45	35	560	490	440	380	280	160	—	—	—
50	39	720	660	610	550	450	350	130	—	—
55	43	960	900	810	780	670	550	320	150	—
60	47	1200	1140	1100	1020	910	800	550	420	180
65	50	1410	1350	1310	1220	1120	1000	770	600	370
70	53	1620	1560	1520	1420	1350	1230	1000	820	580
75	55	1790	1730	1630	1580	1510	1420	1160	1040	780

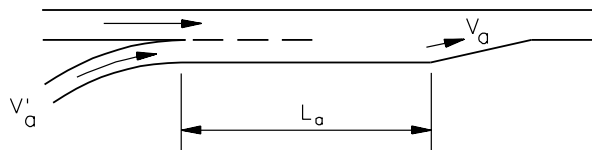

Parallel Type

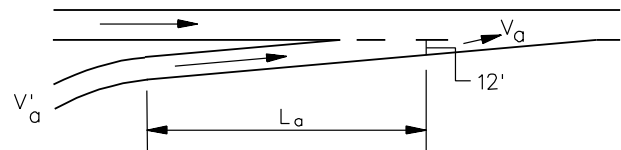

Taper Type

Notes:

1. The acceleration lengths are calculated from the distance needed for a passenger car to accelerate from the average running speed of the entrance curve to reach a speed (V_a) of approximately 5 miles per hour below the average running speed on the mainline.
2. These values are for grades less than 3 percent. See [Figure 16.4J](#) for adjustments for steeper upgrades.
3. Select the actual design speed of the mainline and ramp when using this Figure.

**LENGTHS FOR ACCELERATION
(Passenger Cars)**

Figure 16.4I

Design Speed of Highway (mph)	Ratio of Acceleration Length on Grade (G) to Length on Level				
	For Entrance Curve Design Speed (mph)				
	20	30	40	50	All Speeds
	3% ≤ G ≤ 4% Upgrade				3% ≤ G ≤ 4% Downgrade
40	1.3	1.3	—	—	0.7
45	1.3	1.35	—	—	0.675
50	1.3	1.4	1.4	—	0.65
55	1.35	1.45	1.45	—	0.625
60	1.4	1.5	1.5	1.6	0.6
65	1.45	1.55	1.6	1.7	0.6
70	1.5	1.6	1.7	1.8	0.6
	4% < G ≤ 6% Upgrade				4% < G ≤ 6% Downgrade
40	1.5	1.5	—	—	0.6
45	1.5	1.6	—	—	0.575
50	1.5	1.7	1.9	—	0.55
55	1.6	1.8	2.05	—	0.525
60	1.7	1.9	2.2	2.5	0.5
65	1.85	2.05	2.4	2.75	0.5
70	2.0	2.2	2.6	3.0	0.5

Notes:

1. *No adjustment is needed on grades less than 3 percent.*
2. *The “grade” in the table is the average grade measured over the distance for which the acceleration length applies. See [Figures 16.4G](#) and [16.4H](#).*

**GRADE ADJUSTMENTS FOR ACCELERATION
(Passenger Cars)**

Figure 16.4J

2. Trucks. Where there are a significant number of trucks to govern the design of the ramp, consider providing the truck acceleration distances shown in Figure 16.4K. Typical areas where trucks might govern the ramp design include weigh stations, rest areas, truck stops and transport staging terminals. At other freeway/ramp entrances, the truck acceleration distances should be considered where there is substantial truck traffic and where:
- there is a significant crash history involving trucks that can be attributed to an inadequate acceleration length, and/or
 - there is an undesirable amount of vehicular delay at the junction attributable to an inadequate acceleration length.

Where upgrades exceed 3 percent, the truck acceleration distances may be adjusted for grades. [Figure 12.4B](#) provides the performance criteria for trucks on descending and ascending grades. Before providing any additional acceleration length, the designer must consider the impacts of the added length (e.g., additional construction costs, wider structures, right of way impacts).

3. Horizontal Curves. In many cases, the speed of a vehicle entering the mainline from the ramp will be dictated by a horizontal curve immediately before the freeway/ramp junction. The design speed of this horizontal curve will be determined by the criteria in [Section 11.3](#). This design speed will then be used to read into [Figure 16.4I](#) or [Figure 16.4K](#) to determine the necessary acceleration length.

Two exceptions to the above exist — entrance ramps at diamond interchanges and short entrance ramps. In these cases, the acceleration distance should be determined by that distance needed to accelerate from zero (at the beginning of the ramp) to the mainline design speed. The designer should check to determine if this distance governs.

In all cases, the curve preceding the freeway/ramp entrance should have a radius of 1000 feet or greater.

Example 16.4(2)

Given: Highway Design Speed = 70 miles per hour
 Entrance Ramp Curve Design Speed = 40 miles per hour
 Average Grade = 5 percent upgrade

Problem: Determine length of acceleration required.

Solution: Figure 16.4I yields an acceleration length of 1000 feet on the level. According to Figure 16.4J, this should be increased by a factor of 2.6.

Therefore: $L = (1000)(2.6)$
 $L = 2600$ feet

Provide a 2600-foot acceleration length from the PT of the entrance ramp curve to the beginning of the taper.

Highway Design Speed (mph) (V)	Speed Reached (mph) (V _a)	L _a = Acceleration Length (ft)						
		For Entrance Curve Design Speed (mph)						
		Stop	15	20	25	30	35	40
		For Average Running Speed (mph) (V' _a)						
		0	14	18	22	26	30	36
55*	38	700	600	575	550	500	425	200
60	42	1300	1200	1175	1150	1100	1025	800
65	45	2100	2000	1975	1950	1900	1825	1600
70	48	2800	2700	2675	2650	2600	2525	2300

*For 55 miles per hour, the minimum lengths for passenger cars in Figure 16.4I will apply.

Notes:

1. The acceleration lengths are calculated from the distance needed for a 200-pound per horsepower truck to accelerate from the average running speed of the entrance curve to reach a speed (V_a) that is 10 miles per hour below the average running speed on the mainline.
2. The taper entrance ramp is generally not applicable where trucks govern the design.

**LENGTHS FOR ACCELERATION
 (200-Pound Per Horsepower Truck)**

Figure 16.4K

16.4.2.4 Sight Distance

Drivers on the mainline approaching an entrance terminal should be provided sufficient distance to see the merging traffic so that they can adjust their speed or change lanes to allow the merging traffic to enter the freeway. Likewise, drivers on the entrance ramp need to see a sufficient distance upstream from the entrance to locate gaps in the traffic stream for merging. Therefore, provide decision sight distance according to the criteria in [Section 10.3](#).

16.4.2.5 Superelevation

The entrance ramp superelevation should be gradually transitioned to meet the normal cross slope of the mainline. The principles and criteria for superelevation as discussed in [Section 11.3](#) should be applied to the entrance design. [Section 16.4.1.5](#) provides the superelevation criteria for exit freeway/ramp junctions, which are also applicable to entrance freeway/ramp junctions. This includes e_{max} , superelevation rate, transition lengths and the point of revolution.

16.4.2.6 Cross Slope Rollover

The cross slope rollover is the algebraic difference between the slope of the through lane and the slope of the entrance ramp, where these two are adjacent to each other. The maximum algebraic difference is 4 to 5 percent beyond the physical nose. Between the gore nose and physical nose, the maximum cross slope rollover is 7 percent. See [Section 16.4.2.8](#) for gore area definitions.

16.4.2.7 Shoulder Transitions

At entrance terminals, the right shoulder must be transitioned from the narrower ramp shoulder to the wider freeway shoulder (i.e., 6 feet to 10 feet). [Figures 16.4G](#) and [16.4H](#) illustrate the typical shoulder transition.

16.4.2.8 Gore Area

The following presents the nose dimensions for entrance gores:

1. Painted Nose. The painted nose dimension is considered to be 0.0 feet (i.e., the point where the two paint lines meet).
2. Physical Nose. The physical nose has a dimensional width of 10 feet, which is where the inside ramp edge meets the outside edge of the 10-foot paved freeway shoulder.

3. Gore Nose. The gore nose is where the outside edges of the ramp and mainline paved shoulders are 10 feet apart.

16.4.3 Multilane Terminals

Multilane terminals may be required when the capacity of the ramp is too great for single-lane operation. They may also be used to improve traffic operations (e.g., weaving) at the junction. The following lists several elements the designer should consider when a multilane terminal is required:

1. Lane Balance. Lane balance at the freeway/ramp junction should be maintained; see [Section 16.3.4](#).
2. Entrances. For multilane entrance ramps, desirably a parallel-lane design should be used; however, a taper design may be considered.
3. Exits. For a multilane exit ramp, the additional lane should be added at least 1500 feet prior to the terminal. The total length from the beginning of the first taper to the gore nose will range from 2500 feet for turning volumes of 1500 vehicles per hour or less up to 3500 feet for turning volumes of 3000 vehicles per hour.
4. Signing. Because of the complicated signing that may be required in advance of the exit, coordinate the geometric layout of multilane exits with the Traffic Engineering Division.

16.4.4 Major Fork/Branch Connections

[Figures 16.4L](#) and [16.4M](#) illustrate typical design details for a major fork or branch connection. The following presents a few geometric issues that the designer should consider when designing major divisions:

1. Lane Balance. The principle of lane balance should be maintained; see [Section 16.3.4](#).
2. Divergence Point. Where the alignments of both roadways are on horizontal curves at a major fork, place the painted nose of the gore in direct alignment with the centerline of one of the interior lanes. This provides a driver in the center lane the option of going in either direction. See (a) and (b) in [Figure 16.4L](#). Where one of the roadways is on a tangent at a major fork, the gore design should be the same as a freeway/ramp multilane exit. See (c) in [Figure 16.4L](#).

3. Nose Width. At the painted nose of a major fork, the lane should be at least 24 feet wide but preferably not more than 28 feet. The widening from 12 feet to 24 feet should occur within a distance of 1000 feet to 1800 feet. See (a) in [Figure 16.4L](#).
4. Branch Connection. When merging, provide a full lane width for at least 1000 feet beyond the painted nose. See (b) in [Figure 16.4M](#).

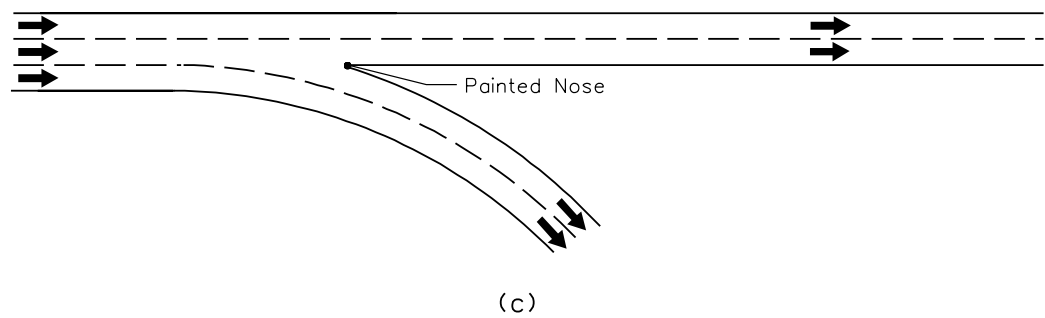
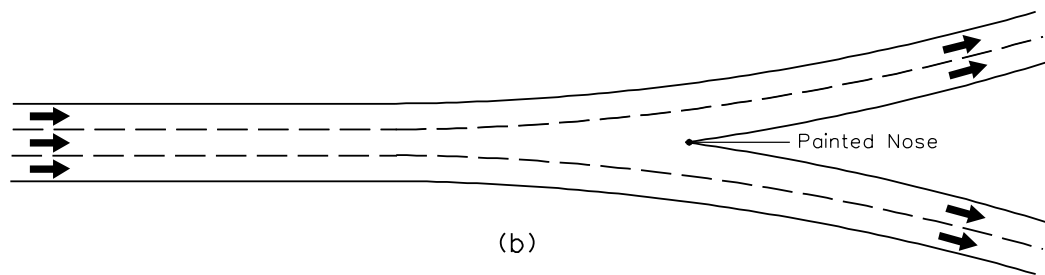
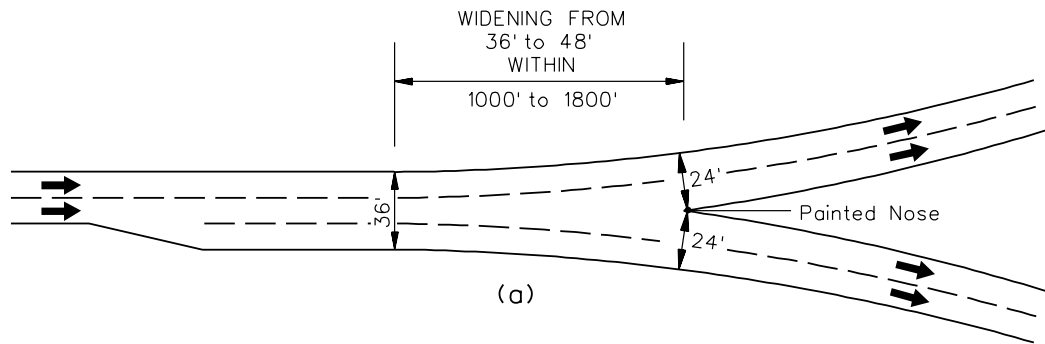

MAJOR FORKS

Figure 16.4L

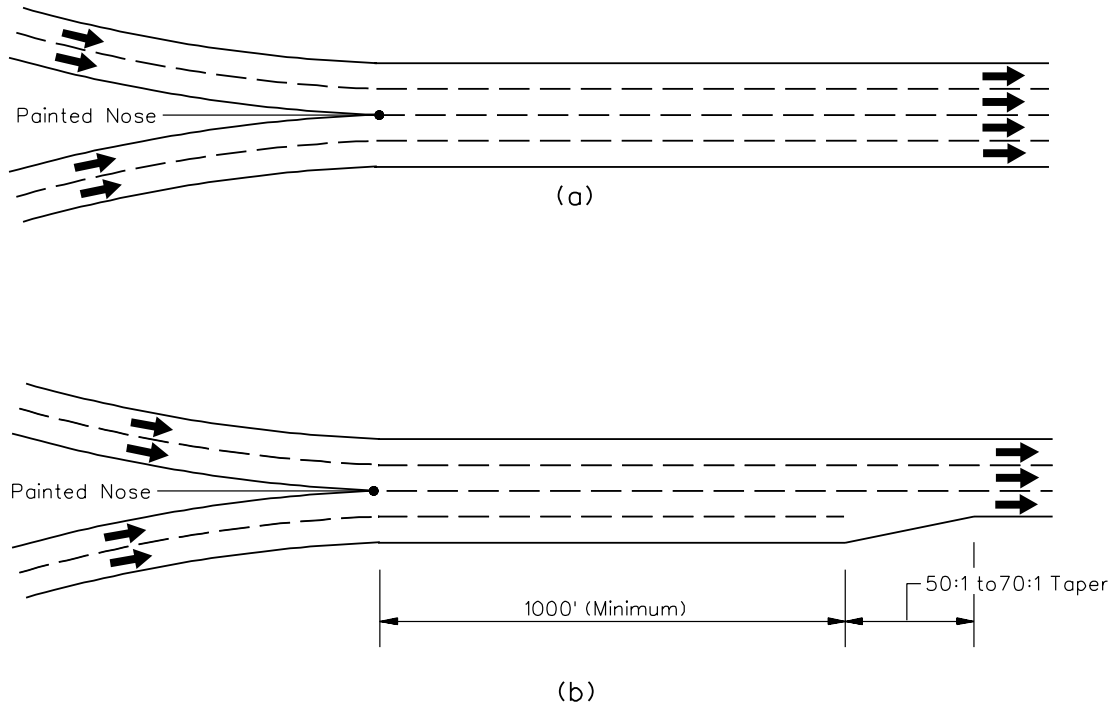

BRANCH CONNECTIONS

Figure 16.4M

16.5 RAMP DESIGN

For design purposes, the ramp proper is assumed to begin at the gore nose for exit ramps and end at the gore nose for entrance ramps.

16.5.1 Ramp Types

The components of a ramp include the freeway/ramp junction, the ramp proper, and a free-flow or controlled ramp terminal at the crossroad. Although ramps have varying shapes, each can be classified into one or more of the types illustrated in [Figure 16.5A](#) and discussed in the following sections.

16.5.1.1 Loop Ramps

There are two types of loop ramps:

1. Free-Flow. The free-flow loop, [Figure 16.5A\(a\)](#), consists of compounded circular arcs that turn through approximately 270 degrees. The free-flow loop is a standard component of the cloverleaf interchange, the four-quadrant partial cloverleaf interchange and the trumpet interchange. Free-flow loops are designed so that either the central arc is a sharper radius than that of the initial and final arcs or the central arc is intermediate between the two. Motorists decelerate from the speed of the through highway over the initial portion of the ramp and accelerate uniformly over the final portion of the ramp.
2. Controlled Terminal. Controlled terminal loops, [Figure 16.5A\(b\)](#), are a component of the partial cloverleaf interchange. Controlled terminals are provided at the intersections with the crossroad and permit both right- and left-turning movements. Wherever practical, the angle of intersection should be 90 degrees.

16.5.1.2 Diagonal Ramps

Diagonal ramps, [Figure 16.5A\(c\)](#), are a component of the diamond interchange. Controlled terminals are provided on the crossroad. The angle of intersection with the crossroad varies between 60 degrees and 90 degrees.

16.5.1.3 Outer-Connector Ramps

Outer-connector ramps are in the same quadrant and to the outside of loop ramps; see [Figure 16.5A\(d\)](#). They may have free-flow operation (e.g., at cloverleaf or trumpet interchanges) or have controlled operations (e.g., at partial cloverleaf interchanges).

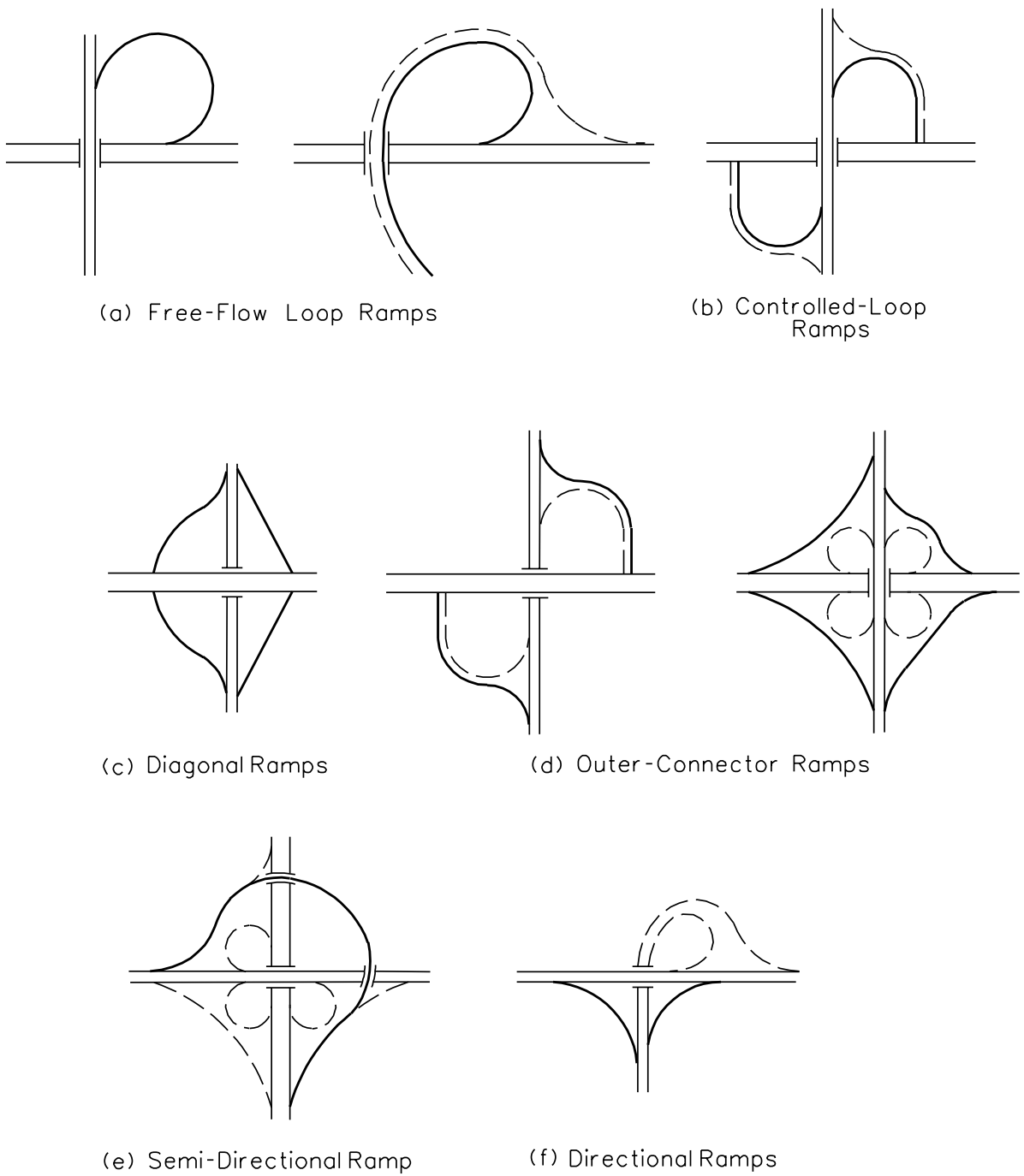

Note: The heavier solid line indicates the ramp type being addressed.

RAMP TYPES
Figure 16.5A

16.5.1.4 Semi-Directional Ramps

Semi-directional ramps are indirect in alignment, yet more direct than a loop ramp. These ramps are illustrated in [Figure 16.5A\(e\)](#). Motorists making a left turn normally exit to the right and initially turn to the right, reversing direction before entering the intersecting highway. The outer connection of the trumpet interchange is also a semi-directional ramp.

16.5.1.5 Directional Ramps

Directional ramps do not deviate greatly from the intended direction of travel. These are illustrated in [Figure 16.5A\(f\)](#) as an element of a trumpet interchange. They are also used to accommodate single-lane and right-turning traffic on four-quadrant partial cloverleafs, semi-directional and directional interchanges.

16.5.2 Design Speed

[Figure 16.5B](#) provides the recommended ranges of ramp design speeds based on the design speed of the mainline. In addition, consider the following when selecting the ramp design speed:

1. Loop Ramps. Design speeds in the middle and high ranges are generally not attainable for loop ramps. The following apply to loop ramps:
 - a. For loop ramps on collector-distributor roadways or in restricted urban conditions, the minimum design speed for loops should be 25 miles per hour.
 - b. Where the truck ADT is greater than 15 percent, use a minimum design speed of 30 miles per hour for the initial curve after the exit curve.

	Mainline Design Speed				
	55 mph	60 mph	65 mph	70 mph	75 mph
	Ramp Design Speed (mph)				
High Range	45-50	50	55	60	65
Middle Range	40	45	45	50	55
Low Range	25-30	30	30	35	40

RAMP DESIGN SPEEDS

Figure 16.5B

- c. For rural loop ramps, a 30 miles per hour design speed is preferred.
 - d. Use a design speed of 40 miles per hour for cloverleaf interchange loop ramps between freeways.
2. Outer Connector Ramps. The design speed for the outer connector ramp of a rural cloverleaf interchange should be 50 miles per hour. Where a wrap-around type ramp is used, use a minimum design speed of 45 miles per hour for the center curve.
 3. Semi-Directional Ramps. Use design speeds in the middle to high ranges for semi-directional ramps. Do not use a design speed less than 30 miles per hour.
 4. Directional Ramps. These include both diagonal ramps at a diamond interchange and ramps at a directional interchange. Use a design speed in the middle to high ranges. Do not use a design speed less than 40 miles per hour.
 5. Controlled Terminals. If a ramp is terminated at an intersection with a stop or signal control, the design speeds in [Figure 16.5B](#) are not applicable to the portion of the ramp near the intersection. The design speed on the ramp near the crossroad intersection can be a minimum of 25 miles per hour.
 6. Variable Speeds. The ramp design speed may vary based on the two design speeds of the intersecting roadways (i.e., mainline design speed and crossroad design speed). The selected design speed should be consistent with the connecting facilities. When using multiple ramp design speeds, the maximum speed differential between controlling design elements (e.g., horizontal curves, vertical curves) should not be greater than 10 to 15 miles per hour. The designer must insure that there is sufficient deceleration distance available between design elements with different design speeds (e.g., two horizontal curves). See [Section 16.5.5](#).

[Figure 16.5C](#) presents geometric design criteria for interchange ramps based on the selected design speed (e.g., sight distance, horizontal and vertical alignment). These are discussed in the following Sections.

16.5.3 Sight Distance

The designer should insure that stopping sight distance is continuously provided along the interchange ramp. Because ramps are composed of curves of various radii and design speeds, sight distance requirements may vary over the length of the ramp. Decision sight distance should be checked for complex maneuvers. [Figure 16.5C](#) provides a summary of the geometric criteria for ramps, including stopping sight distance.

GEOMETRIC REQUIREMENTS										
RAMP DESIGN SPEED (mph)	65	60	55	50	45	40	35	30	25	
STOPPING SIGHT DISTANCE (ft)	645	570	495	425	360	305	250	200	155	
HORIZONTAL ALIGNMENT										
Minimum Radius (ft)	$e_{max} = 8\%$	1485	1205	965	760	600	465	350	250	170
Minimum Length of Arc (ft)	See Figure 16.5G									
VERTICAL ALIGNMENT										
Maximum Grades	3%-5%	3%-5%	3%-5%	3%-5%	3%-5%	4%-6%	4%-6%	5%-7%	5%-7%	
Crest Vertical Curves (K-values)*	193	151	114	84	61	44	29	19	12	
Sag Vertical Curves (K-values)*	157	136	115	96	79	64	49	37	26	

*K-values are based on stopping sight distance on level grades.

ALIGNMENT CRITERIA FOR INTERCHANGE RAMPS

Figure 16.5C

16.5.4 Cross Section Elements

Figure 16.5D presents the typical cross sections for tangent and loop ramps. The following also applies to the ramp cross section:

1. Width. The total paved ramp width will be the sum of the ramp traveled way, the left shoulder and the right shoulder. For most ramps, the typical ramp traveled way is 16 feet. For locations with significant numbers of trucks and tight radii, consider widening the ramp shoulders. If the facility has unpaved shoulders, review the ramp shoulder criteria from the AASHTO *A Policy on Geometric Design of Highways and Streets* to determine the applicable ramp width. Assume the Case II and “C” design traffic conditions.

The typical right-paved shoulder is 6 feet, and the typical left-paved shoulder is 4 feet in the direction of travel. The left shoulder-traveled way-right shoulder arrangement is illustrated in the ramp cross sections in Figure 16.5D. For multilane directional ramps, the cross sectional width is the same as the mainline design (e.g., 24-foot traveled way width plus shoulders); see Chapter 19.

2. Cross Slope. For tangent sections, the ramp traveled way is sloped unidirectionally at 2.08 percent towards the right shoulder. Shoulder cross slopes on tangent are typically 4.17 percent. The left shoulder is typically sloped away from the traveled way.
3. Curbs. Curbs should not be used on ramps with a design speed greater than or equal to 45 miles per hour. If curb and gutter is required for drainage, use sloping curb and place it on the outside edge of the full-width paved shoulders. See Sections 13.2.6 and 21.2.9 for information on the use of curbs.
4. Bridges and Underpasses. Carry the full width of the ramp (shoulders and travel lanes), across the bridge. See Chapters 13 and 19 when determining the clear ramp width for an underpass.
5. Side Slopes/Ditches. For the ramp proper, side slopes and ditches should meet the same criteria as for the highway mainline. Chapters 13 and 19 provide the applicable design information for side slopes and ditches.
6. Roadside Safety. Measure the clear zone from the edge of the traveled way on both sides of the ramp using the criteria in Section 14.3. Barrier warrants, selection and layout will be based on the criteria in Chapter 14.
7. Right of Way. The right of way adjacent to the ramp is fully access controlled and the right of way is typically fenced. See Chapter 30.

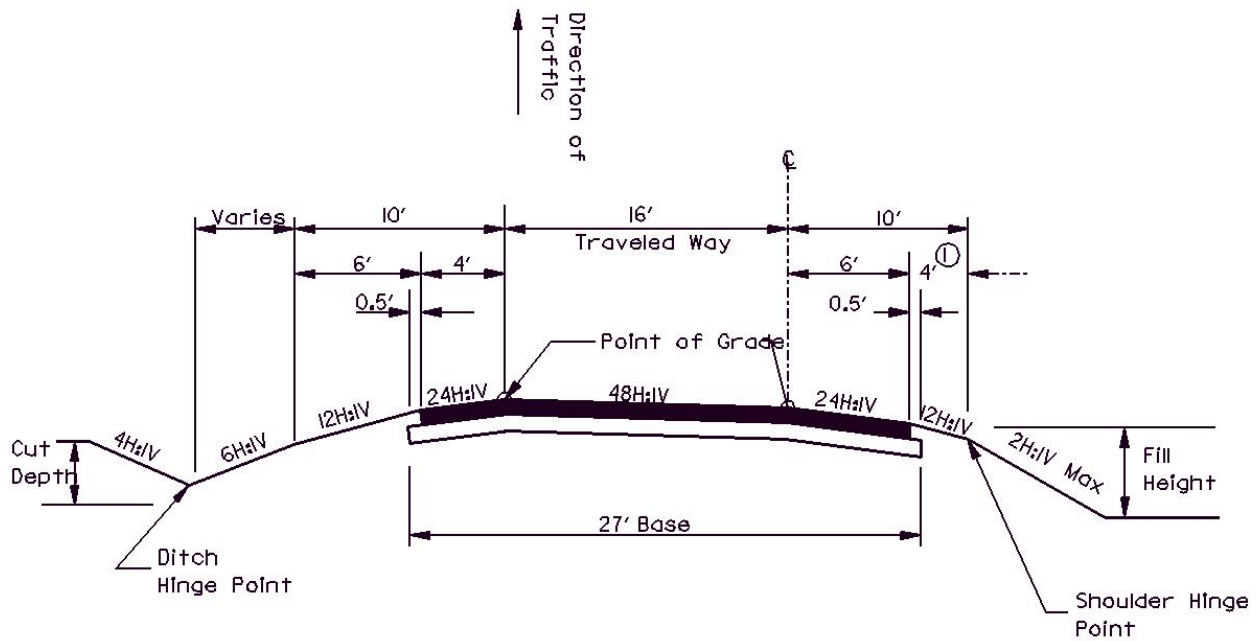

One-Way Freeway Ramp

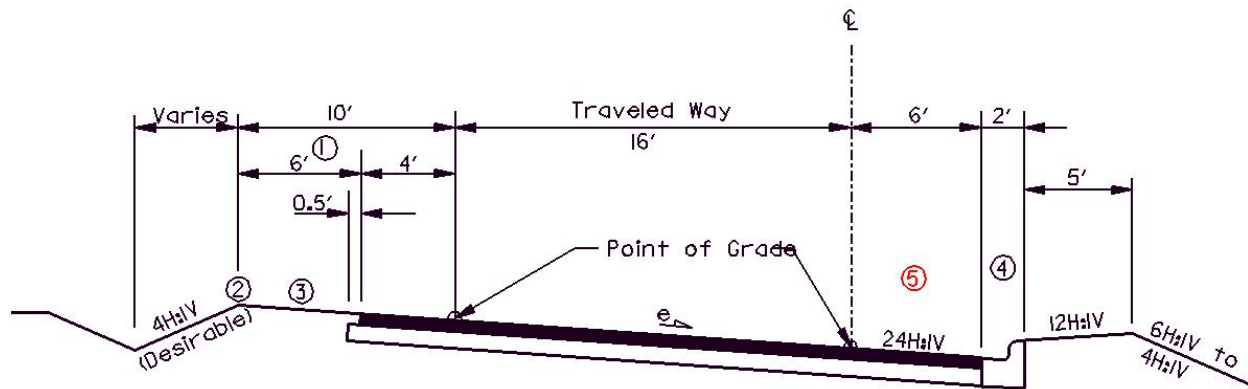

Loop Ramp

Notes:

- ① Add 3.5 feet where guardrail is used.
- ② See [Section 11.3](#) for maximum shoulder break.
- ③ Same slope as traveled way.
- ④ Curb and gutter is only used where necessary and will be determined on a case-by-case basis.
- ⑤ *Shoulder to rotate with roadway when roadway meets 24:1*

TYPICAL RAMP CROSS SECTIONS

Figure 16.5D

16.5.5 Horizontal Alignment

The following will apply to the horizontal alignment of ramps:

1. Minimum Curve Radii. [Figure 16.5C](#) provides the minimum curve radii based on ramp design speed and e_{\max} .
2. Superelevation Rates. The maximum superelevation rate on the ramp is $e_{\max} = 8$ percent. See [Figure 16.5E](#) and [Section 11.3](#) for superelevation rates based on design speed and curve radius. For ramp design speeds greater than 50 miles per hour, see [Figure 11.3B](#).

Because of the restrictive nature of ramps, the designer should insure that the design superelevation rates are not in place for only a short distance. This superelevation rate should be maintained for at least one to two seconds of travel time based on the design speed of the ramp.

3. Curve Type. On all except loop ramps, simple curves should be used unless field constraints (e.g., to avoid an obstruction) dictate the use of compound curvature. On loop ramps, compound curves are typically used, with the interior curve(s) of sharper radii than the exterior curves. For exits with loops, the radii of the flatter arc compared to the radii of the sharper arc should not exceed a ratio of 2:1 to prevent abruptness in operation and appearance. Where compound arcs of decreasing radii are used, the arcs should have sufficient length to enable motorists to decelerate at a reasonable rate over the range of design speeds. See [Figure 16.5F](#).

Comparable radii and length controls may be used on entrance loop ramps with compound arcs of increasing radii. However, for entrance ramps, the 2:1 ratio of compound curves and the lengths in [Figure 16.5F](#) are not as critical because the vehicle is accelerating into a curve with a larger radius or into a tangent section.

4. Trucks. Where there are a significant number of trucks on loop ramps, the designer should consider how the design may impact the rollover potential for large trucks. To reduce this potential, consider using flatter curve radii and/or a higher ramp design speed than the allowable minimums. Other critical factors include insuring that ample deceleration lengths are available and, if judged necessary by the Traffic Engineering Division, special "rollover" warning signs for trucks.

Approx. D*	R (ft)	V = 25 mph		V = 30 mph		V = 35 mph		V = 40 mph		V = 45 mph		V = 50 mph	
		e (%)	L (ft)	e (%)	L (ft)	e (%)	L (ft)	e (%)	L (ft)	e (%)	L (ft)	e (%)	L (ft)
0°15'	23000	NC	0	NC	0	NC	0	NC	0	NC	0	NC	0
	20000	NC	0	NC	0	NC	0	NC	0	NC	0	NC	0
	17000	NC	0	NC	0	NC	0	NC	0	NC	0	NC	0
0°30'	14000	NC	0	NC	0	NC	0	NC	0	NC	0	NC	0
	12000	NC	0	NC	0	NC	0	NC	0	NC	0	NC	0
0°45'	10000	NC	0	NC	0	NC	0	NC	0	NC	0	NC	0
	8000	NC	0	NC	0	NC	0	NC	0	NC	0	NC	0
1°00'	6000	NC	0	NC	0	NC	0	NC	0	RC	62	RC	67
	5000	NC	0	NC	0	NC	0	RC	57	RC	62	2.4	77
1°30'	4000	NC	0	NC	0	RC	54	RC	57	2.4	71	2.9	93
	3500	NC	0	NC	0	RC	54	2.3	63	2.7	80	3.2	102
2°00'	3000	NC	0	RC	50	2.1	54	2.6	72	3.1	92	3.7	118
	2°30'	2500	NC	0	RC	50	2.5	65	83	3.7	110	4.3	138
3°00'	2000	RC	48	2.4	58	3.0	77	3.7	102	4.4	130	5.1	163
	1800	RC	48	2.6	63	3.3	85	4.0	110	4.7	139	5.5	176
3°30'	1600	2.2	50	2.9	70	3.6	93	4.4	121	5.2	154	5.9	189
	1400	2.4	55	3.2	78	4.0	103	4.8	132	5.6	166	6.4	205
5°00'	1200	2.8	64	3.6	87	4.5	116	5.4	149	6.2	184	7.0	224
	1000	3.3	75	4.2	102	5.1	132	6.0	166	6.8	201	7.6	243
7°00'	900	3.5	80	4.5	109	5.5	142	6.4	177	7.2	213	7.8	250
	800	3.9	89	4.9	119	5.9	152	6.8	188	7.6	225	8.0	256
8°00'	700	4.3	98	5.3	128	6.3	163	7.2	199	7.9	234	R _{min} = 760 ft (L = 256 ft)	
	600	4.8	110	5.8	141	6.8	176	7.6	210	8.0	237		
11°00'	500	5.3	121	6.4	155	7.4	191	8.0	221	R _{min} = 600 ft (L = 237 ft)		e _{max} = 0.08 or 8.0 %	
13°00'	450	5.6	128	6.7	162	7.7	199	R _{min} = 465 ft (L = 221 ft)					
14°00'	400	6.0	137	7.1	172	7.9	204			R _{min} = 350 ft (L = 206 ft)			
16°00'	350	6.4	146	7.5	182	8.0	206	R _{min} = 250 ft (L = 194 ft)					
20°00'	300	6.8	155	7.8	189	R _{min} = 170 ft (L = 183 ft)							
23°00'	250	7.4	169	8.0	194			R _{min} = 170 ft (L = 183 ft)					
	200	7.9	181	R _{min} = 170 ft (L = 183 ft)									

* The roughly approximate degree of curve values are shown for information only. Use the applicable curve radius to determine the design superelevation rate.

Key to Table:

R = Radius of curve in feet.

R_{min} = Calculated minimum radii in feet, which have been rounded to the next highest 5-foot increment.

V = Design speed in miles per hour.

e = Superelevation rate shown as a percent.

L = Minimum length of superelevation runoff in feet, from adverse cross slope removed to full superelevation, for a ramp and the point of revolution about the centerline. The calculated tangent runoff length must be added to this number. Values in table assume 16-foot widths.

NC = Normal crown (2.08 percent typical).

RC = Remove adverse crown; i.e., superelevate traveled way at normal cross slope.

Note: See Figure 11.3E for more precise radii ranges for NC and RC.

SUPERELEVATION RATE (e) MINIMUM LENGTH OF RUNOFF (L) FOR RAMPS

Figure 16.5E

Radius (ft)	100	150	200	250	300	400	500 or more
Minimum (ft)	40	50	60	80	100	120	140
Desirable (ft)	60	70	90	120	140	180	200

Note: These lengths are applicable to ramp curves followed by a curve 1/2 its radius or preceded by a curve of double its radius.

ARC LENGTHS FOR COMPOUND CURVES

Figure 16.5F

5. Superelevation Transition. The criteria in [Section 11.3](#) for calculating superelevation transition lengths apply to transitioning the ramp from its normal cross slope on tangent to the needed superelevation on curves. The point of revolution is typically about the inside edge of the ramp traveled way. Therefore, “W” in [Equation 11.3.1](#) will be the ramp traveled way (i.e., 16 feet). [Figure 16.5E](#) provides the minimum superelevation runoff distance for 16-foot ramps. For design speeds greater than 50 miles per hour, use [Figure 11.3B](#) to determine the applicable superelevation rate and [Equation 11.3.1](#) to determine the runoff distances. Do not use the runoff distances shown in [Figure 11.3B](#). Use [Figure 11.3A](#) to determine the relative longitudinal gradient.
6. Superelevated Shoulders. The shoulder treatment on superelevated ramp curves is the same as for superelevated mainline curves. See [Section 11.3.4](#).
7. Baseline/Centerline. The following will apply:
 - a. Ramp. Typically, the outside edge (away from the interior of the interchange) of the ramp traveled way is used for horizontal and vertical control. This edge may be used for the point of grade/revolution or the designer may choose to use the inside edge.
 - b. Loop. Typically, the inside edge (near the interior of the interchange) of the loop traveled way is used for horizontal and vertical control. This edge may be used for the point of grade/revolution or the designer may choose to use the outside edge.
8. Reverse Curves. Reverse curves may be required to:
 - meet restrictive right of way conditions,
 - provide for a better location of the intersection on the crossroad, and/or
 - provide a preferred angle of intersection with the crossroad.

Typically, it is necessary to design the reverse curves with a continuously rotating plane between the curves as shown in [Figure 16.5G](#). The desirable distance between the PT and PC will be 67 percent of each superelevation runoff requirement added together:

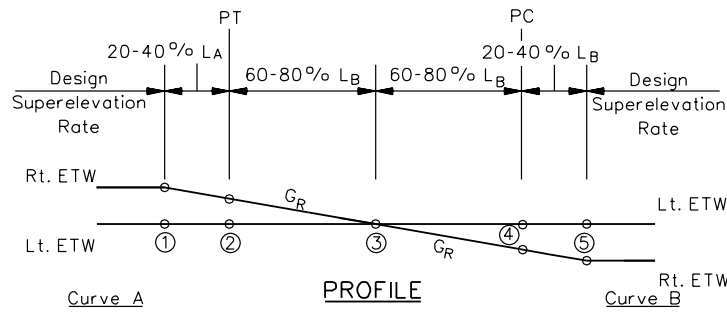
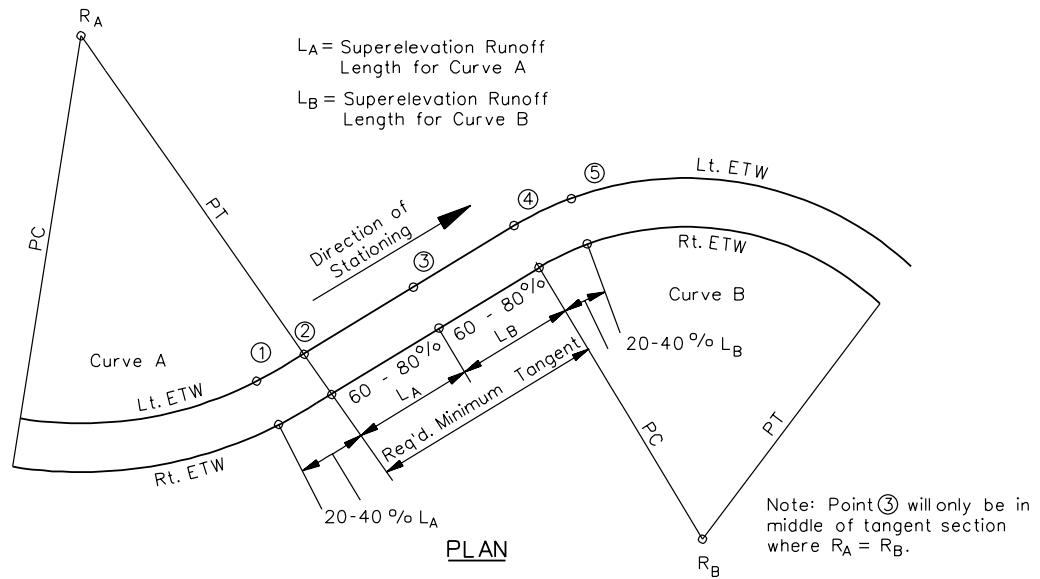

G_R = Relative Longitudinal Gradient, See Figure 11.3A.

e_A = Design Superelevation Rate for Curve A

e_B = Design Superelevation Rate for Curve B

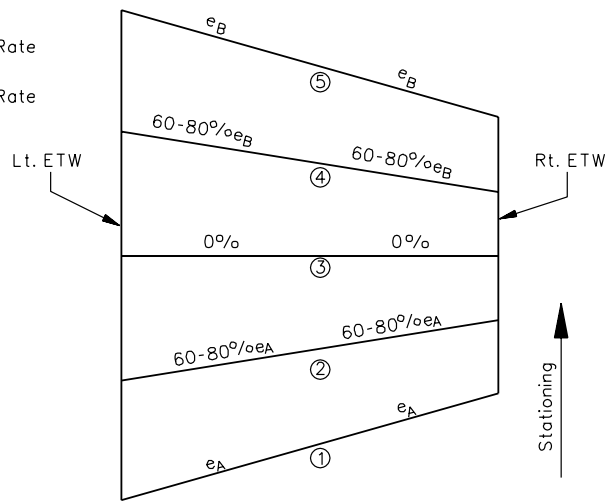

CROSS SECTIONS

**SUPERELEVATION DEVELOPMENT FOR REVERSE CURVES
(Continuously Rotating Plane)**

Figure 16.5G

$$L_{\text{tan}} = 0.67L_A + 0.67L_B \quad \text{Equation 16.5.1}$$

Where:

L_{tan} = tangent distance between PT and PC, feet

L_A = superelevation runoff length for first curve, feet

L_B = superelevation runoff length for second curve, feet

If the ramp has a crown (e.g., two-lane ramp), see [Section 11.3.6](#) for details on superelevating reverse curves.

9. Sight Distance. [Section 11.4](#) presents the criteria for sight distance around horizontal curves based on the curve radii and design speed. These criteria also apply to curves on ramps.
10. Controlled Ramp Termini. Exit ramps may end at a controlled intersection — stop control or signal control. If horizontal curves on the ramps are near the intersection, a design speed, radius and superelevation for the curve should be selected which is appropriate for the expected operational speed on the curve.

16.5.6 Vertical Alignment

16.5.6.1 Grades

Maximum grades for vertical alignment cannot be as definitively expressed as those for the highway mainline. General values of limiting gradient are shown [Figure 16.5C](#), but for any one ramp the selected profile is dependent upon a number of factors. These factors include:

1. The flatter the gradient on the ramp, the longer the ramp will be. At restricted sites (e.g., loops), it may be advantageous to provide a steeper grade to shorten the length of the ramp.
2. Use the steepest gradients for the center portion of the ramp. Freeway/ramp junctions and landing areas at intersections should be as flat as practical.
3. Short upgrades up to 5 percent do not unduly interfere with truck and bus operations. Consequently, for new construction it is desirable to limit the maximum gradient to 5 percent.
4. Downgrades on ramps should follow the same guidelines as upgrades. However, where there are sharp horizontal curves and significant truck and bus traffic, it is desirable to limit the downgrades to 3 to 4 percent.
5. The ramp grade within the freeway/ramp junction up to the physical nose should be approximately the same grade as that provided on the mainline.

16.5.6.2 Vertical Curvature

Design vertical curves on ramps to meet the stopping sight distance criteria based on the ramp design speed as presented in [Chapter 12](#). [Figure 16.5C](#) provides the K-values for both crest and sag vertical curves on level grades. The ramp profile often assumes the shape of the letter S with a sag vertical curve at one end and a crest vertical curve at the other. In addition, where a vertical curve extends onto the freeway/ramp junction, determine the length of curve using a design speed comparable to the mainline. See [Chapter 12](#) for details on the design of vertical curves.

16.5.6.3 Cross Sections Between Adjacent Ramps

Where the alignment of a ramp is designed to be parallel to an adjacent ramp (e.g., cloverleaf, trumpet interchanges), first establish the profile of the loop ramp and then set the profile of the outer ramp to be approximately parallel to the inner-loop ramp profile. Accomplished this by calculating the left-edge elevations of the loop ramp and matching those elevations for the left-edge elevations of the outer ramp.

16.6 RAMP/CROSSROAD INTERSECTION

[Chapter 15](#) presents the Department's in-depth criteria on the design of at-grade intersections. Section 16.6 presents additional information that is applicable to the intersection of an interchange ramp and the crossroad.

At diamond and partial cloverleaf interchanges, the ramp will terminate or begin with an at-grade intersection, either with a stop sign or a traffic signal. In general, the intersection should be designed as described in [Chapter 15](#). This will involve a consideration of capacity and the physical geometric design elements (e.g., sight distance, angle of intersection, acceleration lanes, channelization and turning lanes). The designer should also consider the following in the design of the ramp/crossroad intersection:

1. Crossroad Width. The crossroad width will be based on the anticipated traffic volumes for the design year, the crossroad functional classification and the design criteria presented in [Chapter 15](#).
2. Sight Distance. [Section 10.4](#) discusses the criteria for intersection sight distance (ISD). Ramp/crossroad intersections present unique ISD problems because of the nearby bridge structure at most interchanges. Give special consideration to the location of bridge piers, abutments, sidewalks, bridge rails, roadside barriers, etc.; these elements may present major sight obstructions. The bridge obstruction and the required ISD may result in the relocation of the ramp/crossroad intersection further from the structure. Also, crest vertical curves on the crossroad may need to be flattened to provide adequate sight distance in the vertical plane.
3. Capacity. In urban areas where traffic volumes are often high, inadequate capacity of the ramp/crossroad intersection can adversely affect the operation of the ramp/freeway junction. In a worst-case situation, a backup onto the freeway may impair the safety and operation of the mainline itself. Therefore, give special attention to providing sufficient capacity and storage for an at-grade intersection or a merge with the crossing road. This may require providing additional lanes at the intersection or on the ramp proper, or it could involve traffic signalization where the ramp traffic will have priority. The analysis must also consider the operational impacts of the traffic characteristics in either direction on the intersecting road.
4. Turn Lanes. Exclusive left- and/or right-turn lanes often will be required on the crossroad and in many cases on the ramp itself. [Chapter 15](#) provides information on the design of turn lanes at intersections.
5. Signalization. Where queuing at one intersection is long enough to affect operations at another, the two intersections may require a larger separation, interconnected signals or a four-phase overlap signal design.

6. Design Vehicle. Design all radius returns and left-turn control radii for ramp/crossroad intersections using a WB-62 design vehicle; see [Section 15.3](#).
7. Typical Designs. [Figures 16.6A](#) and [16.6B](#) illustrate typical ramp/crossroad intersections for a diamond interchange. [Figure 16.6A](#) illustrates a three-lane crossroad and [Figure 16.6B](#) a four-lane multilane curb and gutter crossroad with a two-way, left-turn lane.
8. Wrong-Way Movements. Wrong-way movements often originate at the ramp/crossroad intersection onto an exit ramp. To minimize their probability, design the intersection to discourage this movement and sign the exit ramp according to the criteria in the *MUTCD*.
9. Access Control. [Section 9.8.4.2](#) presents detailed information on access control along the crossroad in the vicinity of ramp/crossroad intersections.

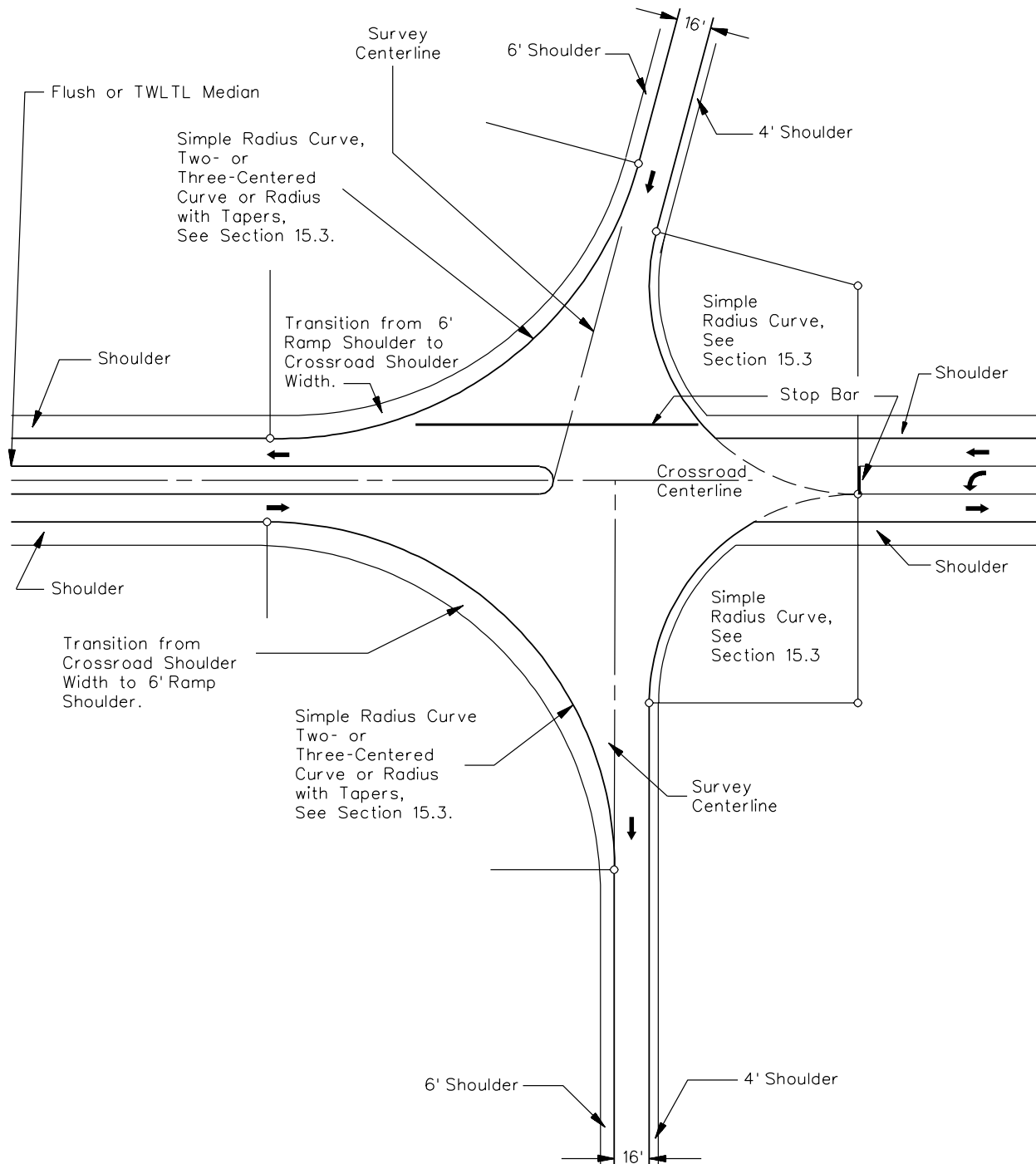

**RAMP/CROSSROAD INTERSECTION — DIAMOND INTERCHANGE
(Three-Lane Crossroad)**

Figure 16.6A

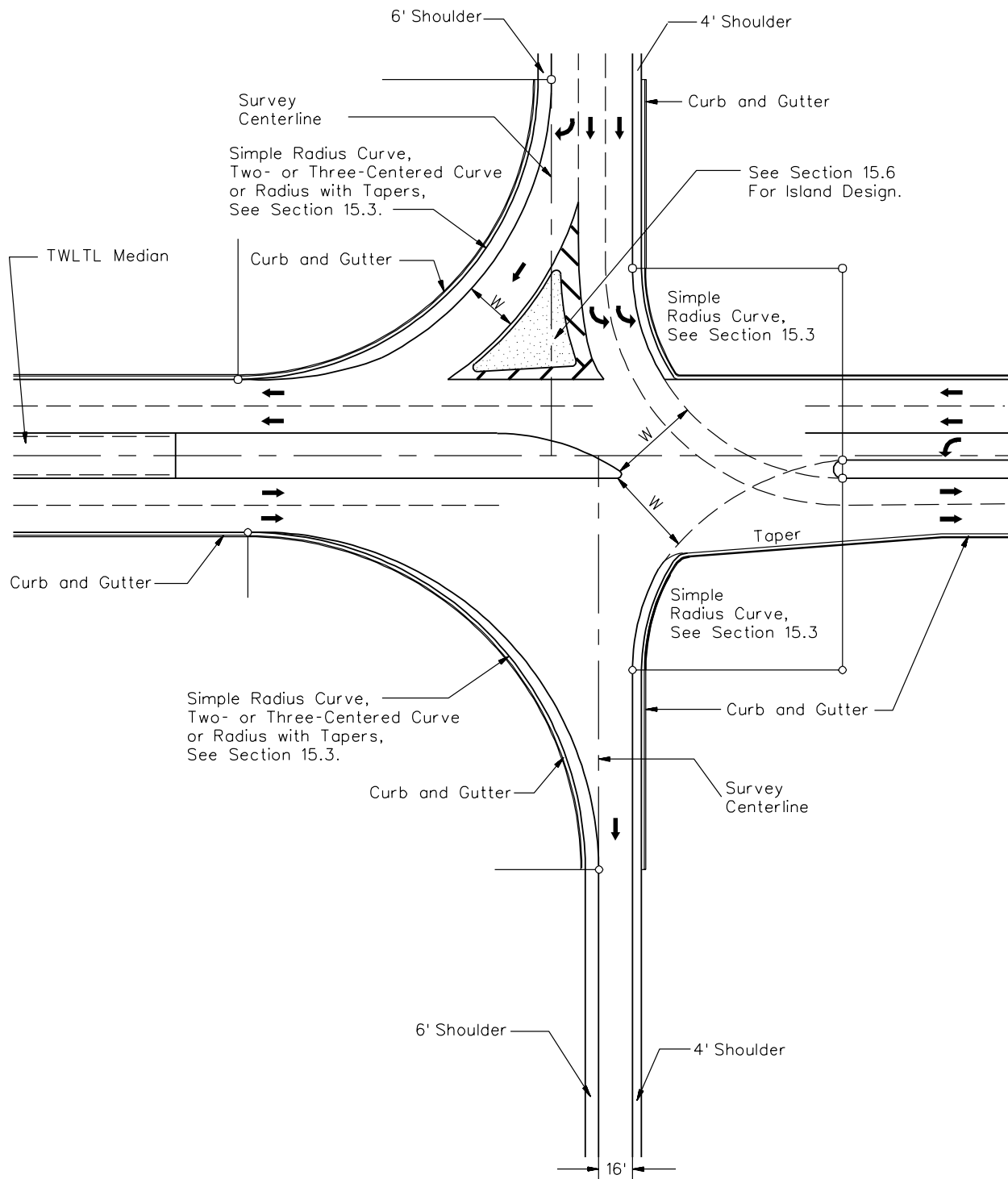

Note: For width of "W," see [Section 15.4.2](#).

**RAMP/CROSSROAD INTERSECTION — DIAMOND INTERCHANGE
(Five-Lane TWLTL Crossroad — Signalized Intersections)**

Figure 16.6B

16.7 REFERENCES

1. *A Policy on Geometric Design of Highways and Streets*, AASHTO, 2001.
2. *A Manual on User Benefit Analysis of Highway and Bus Transit Improvements*, AASHTO, 1977.
3. "Additional Interchanges to the Interstate System," *Federal Register*, Vol. 55, No. 204, October 22, 1990.
4. "Additional Interchanges to the Interstate System," *Federal Register*, Vol. 63, No. 28, February 11, 1998.
5. NCHRP 345, *Single Point Urban Interchange, Design and Operations Analysis*, Transportation Research Board, 1991.
6. *Highway Capacity Manual 2000*, Transportation Research Board, 2000.
7. *Manual on Uniform Traffic Control Devices, Millennium Edition*, FHWA, ATSSA, AASHTO, and ITE, 2001.

Table of Contents

<u>Section</u>	<u>Page</u>
17.1 ACCESSIBILITY FOR DISABLED INDIVIDUALS	17.1(1)
17.1.1 ADA Implementation.....	17.1(1)
17.1.2 Design Considerations	17.1(2)
17.1.2.1 Design Field Review	17.1(2)
17.1.2.2 Design.....	17.1(2)
17.1.3 Buildings.....	17.1(2)
17.1.4 Bus Stops	17.1(3)
17.1.5 Parking	17.1(3)
17.1.5.1 Off-Street Parking	17.1(3)
17.1.5.2 On-Street Parking	17.1(7)
17.1.6 Accessible Route.....	17.1(7)
17.1.6.1 Definition	17.1(7)
17.1.6.2 Selecting Accessible Routes.....	17.1(9)
17.1.6.3 Alternative Sidewalk Routes	17.1(10)
17.1.7 Sidewalks	17.1(10)
17.1.7.1 Criteria for Accessible Routes.....	17.1(10)
17.1.7.2 Criteria for Sidewalks Along Public Rights of Way..	17.1(11)
17.1.8 Stairs	17.1(12)
17.1.9 Ramps	17.1(13)
17.1.10 Curb Ramps	17.1(15)
17.1.10.1 Location	17.1(15)
17.1.10.2 Design.....	17.1(15)
17.1.10.3 Crossing Controls	17.1(16)
17.1.10.4 Types.....	17.1(16)
17.1.11 Detectable Warning Surfaces.....	17.1(18)

Table of Contents

(Continued)

<u>Section</u>	<u>Page</u>
17.1.11.1 Location	17.1(18)
17.1.11.2 Design.....	17.1(18)
17.2 RETAINING WALLS.....	17.2(1)
17.2.1 Selection Process.....	17.2(1)
17.2.2 Blank Page	17.2(3)
17.3 LANDSCAPING.....	17.3(1)
17.4 NOISE CONTROL.....	17.4(1)
17.4.1 General.....	17.4(1)
17.4.2 Definitions.....	17.4(1)
17.4.3 Source Control	17.4(3)
17.4.4 Highway Design	17.4(3)
17.4.5 Traffic Mix and Volume.....	17.4(3)
17.4.6 Noise Barriers.....	17.4(4)
17.5 BUS STOP AND TURNOUTS	17.5(1)
17.5.1 Location.....	17.5(1)
17.5.1.1 Bus Stops.....	17.5(1)
17.5.1.2 Bus Turnouts.....	17.5(1)
17.5.1.3 Selection	17.5(1)
17.5.2 Design	17.5(2)
17.5.2.1 Bus Stops.....	17.5(2)
17.5.2.2 Bus Stop Pads	17.5(2)
17.5.2.3 Bus Turnouts.....	17.5(2)
17.5.2.4 Bus Shelters.....	17.5(2)
17.6 MAILBOXES.....	17.6(1)
17.7 REFERENCES	17.7(1)

Chapter Seventeen

SPECIAL DESIGN ELEMENTS

The designer must address numerous design elements that are not directly related to the geometric design of the roadway. This Chapter provides a discussion on several of these design elements including disabled accessibility requirements, retaining walls, landscaping, noise control, bus stops/turn outs and mailboxes.

17.1 ACCESSIBILITY FOR DISABLED INDIVIDUALS

Many highway elements can affect the accessibility and mobility of disabled individuals. These include sidewalks, parking lots, buildings at transportation facilities, overpasses and underpasses. In 1993, the Department formed a committee to review and implement the 1990 *Americans with Disabilities Act* (ADA). The results of the committee's action can be found in the Department's publication "Report on the Implementation of the Americans with Disabilities Act in Public Rights of Way (Excluding Buildings)." The following Sections present accessibility criteria that are based on information presented in the *ADA Accessibility Guidelines for Buildings and Facilities* (ADA Guidelines) prepared by the US Architectural and Transportation Barriers Compliance Board. Designers are required to meet the criteria presented in the following sections. Where other agencies or local codes require criteria that exceed the *ADA Guidelines*, then the stricter criteria may be required. This will be determined on a case-by-case basis.

17.1.1 ADA Implementation

When implementing ADA criteria on highway projects, the designer should consider the following:

1. New Construction. ADA compliance will be measured against the new construction criteria in Section 17.1 and *ADA Guidelines*. For most projects, the designer will have the flexibility in the design to implement the new ADA construction criteria.
2. Alterations. Planned additions or alterations to existing facilities must be accomplished so that the altered facility will be accessible to and usable by persons with disabilities to the maximum extent feasible. Where existing conditions permit, new ADA construction criteria must be implemented. Also note that any element that can be made accessible should be (e.g., curb ramps), even if the facility as a whole cannot be made fully accessible. Changes that affect existing pedestrian facilities should include adjacent work as necessary to

insure that grades, finishes and surfaces will meet or match those of the alterations.

3. Existing. For elements in existing right of way not otherwise being altered, the decision to upgrade individual accessibility elements will be determined on a case-by-case basis. If it is not practical to fully meet the *ADA Guidelines* criteria, each feature of accessibility should be maximized within the constraints of the site conditions at that location.
4. Temporary Access. Where a continuous route cannot be provided for pedestrians during construction, an alternative route should be available. This may require temporary walkways and curb ramps to maintain access. Sidewalk barriers should be detectable by visually-impaired pedestrians and pedestrians who are blind.

17.1.2 Design Considerations

17.1.2.1 Design Field Review

During the Design Field Review, identify items such as signal bases, fire hydrants, signs and drainage structures that may affect accessibility. Elevations at key points will also be needed to properly construct accessible facilities. Construction permits or right of way agreements may be required to transition the back of the sidewalk into approaches and features adjacent to the sidewalk.

17.1.2.2 Design

The *Standard Drawings* provide typical design options. However, items such as ramp orientation, sidewalk width and ramp width need to be shown in the plans to supplement the *Standard Drawings*. Providing individual details may be necessary for unique ramp configurations, particularly where existing sidewalks are being retrofitted with ramps. These details should include ramp width, length, orientation and location in addition to elevations and in place features that may affect ramp construction.

17.1.3 Buildings

For interior accessibility criteria, the following will apply:

1. New. All new buildings, airport terminals, rest areas, weigh stations and transit stations (e.g., stations for intercity bus, intercity rail, high-speed rail and other fixed guideway systems) shall meet the accessibility criteria set forth in the *ADA Guidelines*. The designer should review the *ADA Guidelines* to determine the

appropriate accessibility requirements for building interiors, including rest rooms, drinking fountains, elevators, telephones, etc.

2. Existing. In general, for alterations made to existing buildings or facilities, the designer must meet the accessibility requirements for the alteration made to the facility, unless it is prohibitively expensive to do so. The designer should review the *ADA Guidelines* to determine the appropriate criteria and, if required, where exceptions may be allowed.

17.1.4 Bus Stops

The following accessibility criteria apply to the construction of bus stops:

1. Bus Stop Pads. New bus stop pads constructed to be used in conjunction with a lift or ramp shall meet the following criteria:
 - a. Provide a firm, stable and slip resistant surface.
 - b. Provide a minimum clear length of 96 inches (measured from the curb or roadway edge) and minimum clear width of 60 inches (measured parallel to the roadway) depending on the legal or site constraints.
 - c. Connect the pad to streets, sidewalks or pedestrian paths by at least one accessible route.
 - d. The slope of pad parallel to the roadway must be the same as the roadway to the maximum extent practical.
 - e. For drainage purposes, provide a maximum cross slope of 2 percent perpendicular to the roadway.
2. Bus Shelters. Where new or replaced bus shelters are provided, install or position them to permit a wheelchair user to enter from the public way and reach a location within the shelter having a minimum clear floor area of 30 by 48 inches. An accessible route shall be provided from the shelter to the boarding area.

17.1.5 Parking

17.1.5.1 Off-Street Parking

The following criteria apply to off-street disabled parking spaces:

1. Minimum Number. [Figure 17.1A](#) provides the criteria for the minimum number of accessible spaces. A typical disabled stall layout is shown in [Figure 17.1B](#).

One out of every eight accessible spaces, but not less than one, shall have an access aisle 96 inches wide and must be designated as van accessible.

2. Location. Parking spaces for disabled individuals and accessible passenger loading zones that serve a particular building shall be the spaces or zones closest to the nearest accessible entrance on an accessible route. In separate parking structures or lots that do not serve a particular building, locate parking spaces for disabled individuals on the shortest possible circulation route to an accessible pedestrian entrance of the parking facility. In buildings with multiple access entrances with adjacent parking, accessible parking spaces shall be dispersed and located closest to the accessible entrances.
3. Signing and Pavement Markings. Designate parking spaces for the disabled with signs and pavement markings that comply with the *MUTCD*. The sign shall not be obscured by a vehicle parked in the space. Van-accessible spaces shall have an additional sign stating the space is "Van-Accessible."
4. Dimensions. The parking spaces designated for the disabled shall be at a minimum 96-inches wide, with a minimum 60-inch access aisle or 96-inch access aisle next to van-accessible spaces or the space should be parallel to a sidewalk on a public highway. Two parking spaces may share the same access aisle. Parking access aisles shall be part of an accessible route to the building or facility entrance. Parked vehicular overhangs shall not reduce the clear width of an accessible circulation route. Parking spaces and access aisles shall be level with surface slopes not exceeding 2 percent in all directions.
5. Passenger Loading Zones. Passenger loading zones shall provide an access aisle at least 60 inches wide and 216 inches long adjacent and parallel to the vehicular pull-up space. If there are curbs between the access aisle and the vehicular pull-up space, provide a curb ramp complying with [Section 17.1.10](#). Vehicular standing spaces and access aisles should be essentially level. Surface slopes shall not exceed 2 percent in all directions for surface slopes.

Total Number of Parking Spaces	Minimum Number of Accessible Spaces
1 to 25	1
26 to 50	2
51 to 75	3
76 to 100	4
101 to 150	5
151 to 200	6
201 to 300	7
301 to 400	8
401 to 500	9
501 to 1000	2% of total
1001 and over	20 plus 1 for each 100 over 1000

Notes:

1. *If one or more passenger loading zones are provided, then at least one passenger loading zone shall comply with Item 5 in [Section 17.1.5.1](#).*
2. *Parking spaces for side-lift vans are accessible parking spaces and may be used to meet the requirements of this Section.*
3. *The total number of accessible parking spaces may be distributed among closely spaced parking lots, if greater accessibility is achieved.*
4. *At least one of every eight spaces, but not less than one shall be van accessible.*

**MINIMUM NUMBER OF ACCESSIBLE SPACES
FOR DISABLED USERS**

Figure 17.1A

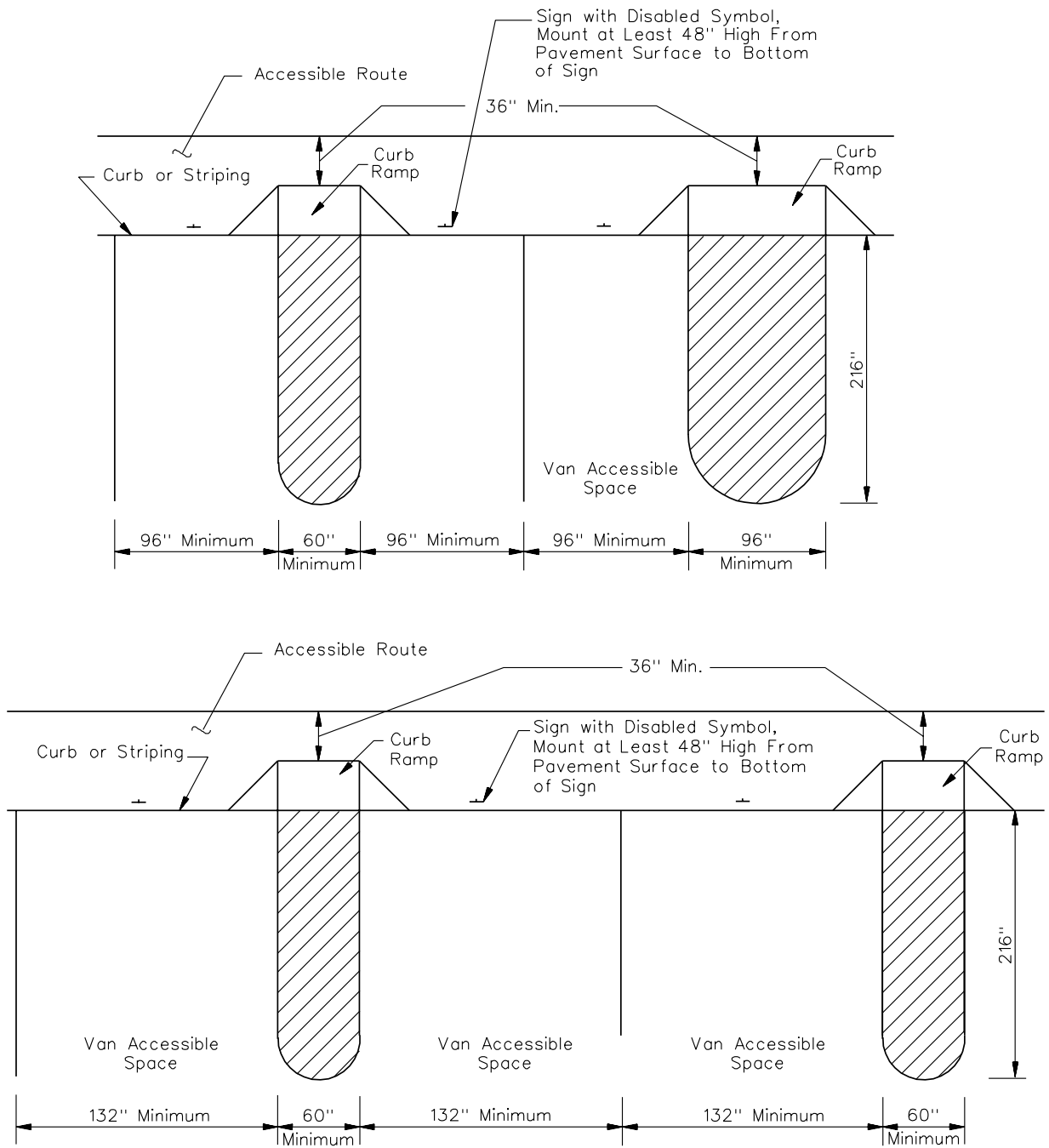

Note: Two accessible parking spaces may share a common access aisle.

**DISABLED PARKING STALL DIMENSIONS
(Off-Street Parking)**

Figure 17.1B

17.1.5.2 On-Street Parking

Where new on-street paid or time-limited parking is provided and designated in districts zoned for business uses, the on-street parking design should meet the following accessibility criteria:

1. Minimum Number. [Figure 17.1A](#) provides the criteria for the minimum number of accessibility spaces that may also be applied to on-street parking. In general, provide one accessible space per block.
2. Location. On-street accessibility parking spaces should be dispersed throughout the project area. To the maximum extent feasible, accessible on-street parking should be located in level areas. The designer should seek input from the local governing agency early in the design process for information concerning local requirements and restrictions.
3. Dimensions. At a minimum, provide a 20-foot parking space with a 60-inch access aisle at the head or foot of the parking space. This is illustrated in [Figure 17.1C](#). The traveled way shall not encroach into the access aisle.
4. Signing and Pavement Markings. Designate parking spaces for the disabled with signs and pavement markings that comply with *MUTCD*. Locate these signs so they are visible from a driver's seat.
5. Curb Ramps. If there are curbs next to an on-street accessible parking space, provide a curb ramp complying with [Section 17.1.10](#). Accessible parking spaces adjacent to intersections may be served by the sidewalk curb ramp at the intersection, provided that the path of travel from the access aisle to the curb ramp is within the pedestrian crossing area.

17.1.6 Accessible Route

17.1.6.1 Definition

An accessible route is a continuous, unobstructed path connecting all accessible elements and spaces in a building, facility or site. A "site" is defined as a parcel of land bounded by a property line or a designated portion of a public right of way. A "facility" is defined as all or any portion of buildings, structures, site improvements, complexes, equipment, roads, walks, passageways, parking lots, or other real or personal property on a site. Interior accessible routes may include corridors, floors, ramps, elevators, lifts and clear floor space at fixtures. Exterior accessible routes may include parking access aisles, curb ramps, crosswalks at vehicular ways, walks, ramps and lifts.

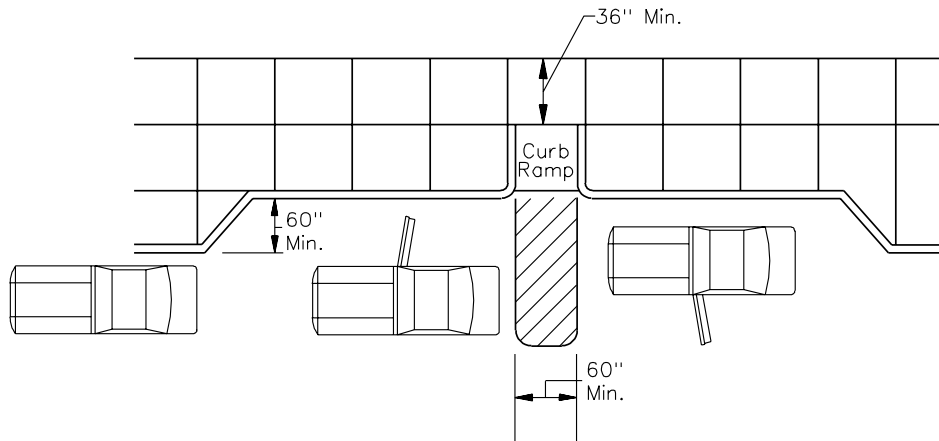

(a) Double Accessible Parking Space with Curb Ramp.

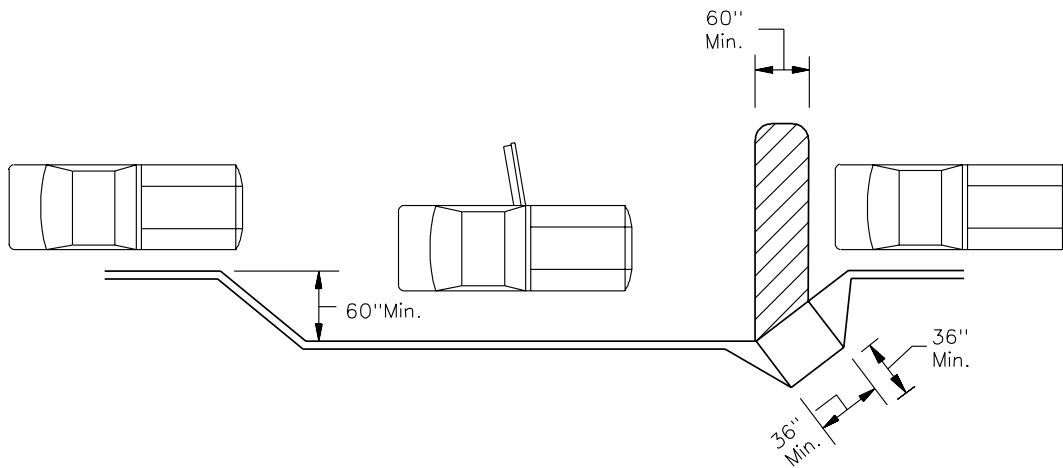

(b) Single Accessible Parking Space with Curb Ramp.

**DESIRABLE DISABLED PARKING DESIGN
(On-Street Parking)**

Figure 17.1C

17.1.6.2 Selecting Accessible Routes

Accessible routes must be provided as follows:

1. Provide at least one accessible route within the boundary of the site from public transportation stops, accessible parking, accessible passenger loading zones, and public streets or sidewalks to the accessible building entrance they serve. The accessible route shall, to the maximum extent feasible, coincide with the route for the general public.
2. At least one accessible route shall connect accessible buildings, facilities, elements and spaces that are on the same site.
3. At least one accessible route shall connect accessible buildings or facility entrances with all accessible spaces and elements and with all accessible dwelling units within the building or facility.

For highway projects, desirably the designer should provide at least one continuously accessible route along the highway. Examine the project area and note the presence or absence of accessible routes. The determination of an accessible route is the responsibility of the designer and should be logical and practical. For instance, a continuously accessible route on sidewalks should not alternate between one side of a highway and the other unless constrained by terrain, slopes or other obstacles, or unless caused by temporary pedestrian re-routing due to work on sidewalks and/or curbs and gutters.

Defining an accessible route may require coordination with the local agency involved in maintaining the continuous route. This also may require coordinating with local support groups. When determining the location of a continuously accessible route, consider the following:

- location of pedestrian generators, particularly those in high priority areas that would be likely to serve disabled pedestrians (e.g., medical facilities, high-rise buildings, housing for the elderly, shopping areas, nursing homes, libraries, government buildings and offices);
- location of existing sidewalks and curb ramps;
- location of existing utilities, signs or other poles, or features (e.g., steps) that would need to be removed to provide full accessibility;
- existing ground contours that would affect the longitudinal and transverse gradient of sidewalks and ramps;

- location of marked crosswalks; and
- presence of drainage features (e.g., inlets, manholes).

17.1.6.3 Alternative Sidewalk Routes

The presence of alternative accessible routes lessens the need for reconstruction in areas in which the terrain or proximity of structures to the sidewalk line will cause substantial difficulty and cost in reconstruction of curb ramps. For example, vaulted sidewalks attached to adjacent structures should not be altered if structural modifications to buildings are required. If an alternative accessible route is available within one city block, curb ramps with construction difficulties may not need to be reconstructed to comply with the accessibility criteria. In these cases, contact the Department's ADA Coordinator for guidance and policy interpretation.

For roadway cross sections with 4 or more lanes, all planned or existing islands or curbed medians should include flat mid-crossing refuges to insure that disabled individuals in wheelchairs have a place to wait for signal changes.

Certain high-volume roads such as important regional and local arterials (i.e., 2 or more lanes of travel in each direction) may limit pedestrian crossings to important intersections with pedestrian signal cycles to preserve capacity.

17.1.7 Sidewalks

[Section 21.2.10](#) presents the Department's warrants and design criteria for sidewalks. In addition, all sidewalks must comply with the *ADA Guidelines* presented in the following Sections. Most sidewalks along public highways are considered public rights of way routes.

17.1.7.1 Criteria for Accessible Routes

For sidewalks on accessible routes, the following accessibility criteria shall be met:

1. Width. The typical sidewalk width is 60 inches. Because of restrictions (e.g., poles, mailboxes, fire hydrants), the minimum clear width at any isolated point along an accessible route shall be 36 inches.
2. Passing Space. If the sidewalk has less than 60-inch clear width for an extended distance, then passing spaces at least 60 inches by 60 inches shall be located at reasonable intervals not to exceed 200 ft. A T-intersection between two walks is an acceptable passing space. Paved driveways meeting ADA requirements also provide acceptable passing space in residential areas.

3. Surface. All sidewalk surfaces shall be stable, firm and slip resistant. The longitudinal gradient should be flush and free of abrupt changes. However, changes in level up to $\frac{1}{4}$ inch may be vertical and without edge treatment. Changes in level between $\frac{1}{4}$ inch and $\frac{1}{2}$ inch shall be beveled with a slope no greater than 2H:1V. Changes greater than $\frac{1}{2}$ inch shall be accommodated with a ramp; see [Section 17.1.9](#).
4. Drainage. Grates should not be placed within the walking surface. If, however, gratings must be located in walking surfaces, then they shall have spaces no greater than $\frac{1}{2}$ inch wide perpendicular to the dominant direction of travel.
5. Slopes. The sidewalk cross slope shall not exceed 2 percent. If the longitudinal gradient exceeds 5 percent, the sidewalk must meet the accessibility criteria for ramps; see [Section 17.1.9](#). Where driveways or alleys intersect with sidewalks, give design priority to the sidewalk rather than to the driveway or alley. This may require ramping the sidewalk down to the driveway. These longitudinal gradients must meet the criteria in [Section 17.1.9](#) for ramping of sidewalks.
6. Protruding Objects. Freestanding objects mounted on posts or pylons may overhang their mountings up to a maximum of 12 inches when located between 27 inches and 80 inches above the sidewalk or ground surface. Protruding objects less than 27 inches or greater than 80 inches may protrude any amount provided that the effective width of the sidewalk is maintained. Where the vertical clearance is less than 80 inches, provide a barrier to warn the blind or visually-impaired person.
7. Bus Stops. Where bus passenger-loading areas or bus shelters are provided on or adjacent to sidewalks, they must comply with the criteria in [Section 17.1.4](#).
8. Curb Ramps/Crosswalks. All curb ramps and crosswalks on an accessible route must comply with the criteria in [Section 17.1.10](#).

17.1.7.2 Criteria for Sidewalks Along Public Rights of Way

In general, sidewalks along public rights of way should meet the criteria presented in [Section 17.1.7.1](#). However, some flexibility is required to meet the adjacent roadway conditions and to provide practical designs. The project scoping team should identify and document all non-accessible routes and facilities during the Design Field Review. The criteria in [Section 17.1.7.1](#) should be implemented, unless noted as follows:

1. Slopes. Provide the flattest longitudinal gradient practical. The sidewalk slope should not exceed the running slope for the adjacent roadway.
2. Cross Slopes. Cross slopes greater than 2 percent may be used provided adjacent portions are free of abrupt changes. The designer should strive to achieve the flattest cross slope practical.

3. **Stairs.** Sidewalks with stairs are allowed on non-accessible routes, provided an unobstructed route is available between accessible entrances. [Section 17.1.8](#) presents criteria for stairs.
4. **Separation.** Sidewalks adjacent to the curb or roadway may be offset to avoid a non-conforming cross slope at driveway aprons by diverting the sidewalk around the apron; see [Figure 17.1D](#).
5. **Protruding Objects.** Objects on or along a sidewalk that are not fixed (e.g., newspaper vending machines, trash receptacles) are not subject to the *ADA Guidelines*. Fixed items (e.g., signal controller cabinets, light standards, utility poles, mailboxes, sign supports) should not be placed within the sidewalk. In those locations where it is impractical to avoid this situation, maintain a minimum access width of at least 36 inches.

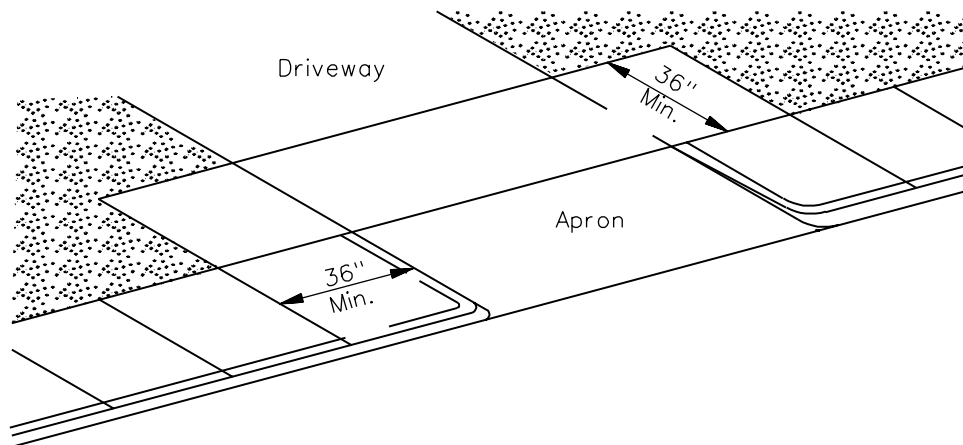

SIDEWALKS AT DRIVEWAY APRONS

Figure 17.1D

17.1.8 **Stairs**

Stairs shall not be part of an exterior accessible route because they cannot be safely negotiated by individuals in wheelchairs. Where stairs are used, they should be designed to be accessible by other disabled individuals. Therefore, the design of stairs must comply with Section 4.9 of the *ADA Guidelines*. This includes the provision of handrails.

17.1.9 Ramps

Any part of an accessible route with a slope greater than 5 percent shall be considered a ramp and shall conform to the *ADA Guidelines* for the design of ramps. This includes the provision of handrails. The following criteria must be met for ramps on accessible routes:

1. Slope and Rise. The least possible slope should be used for any ramp. [Figure 17.1E](#) provides the maximum allowable ramp slopes for new construction. Curb ramps and ramps to be constructed on existing sites or in existing buildings or facilities may have slopes and rises as shown in [Figure 17.1F](#), if space limitations prohibit the use of a 12H:1V slope or less.
2. Width. The minimum clear width of a ramp shall be 36 inches.

Slope	Maximum Rise	Maximum Run
Steeper than 16H:1V but no steeper than 12H:1V	30 inches	30 feet
Steeper than 20H:1V but no steeper than 16H:1V	30 inches	40 feet

Note: A slope steeper than 12H:1V is not allowed.

ALLOWABLE RAMP DIMENSIONS (New Construction)

Figure 17.1E

Slope	Maximum Rise	Maximum Run
Steeper than 10H:1V but no steeper than 8H:1V	3 inches	2 feet
Steeper than 12H:1V but no steeper than 10H:1V	6 inches	5 feet

Note: A slope steeper than 8H:1V is not allowed.

ALLOWABLE RAMP DIMENSIONS (Existing Sites, Buildings and Facilities)

Figure 17.1F

3. Landings. Ramps shall have level landings at the bottom and top of each run and shall have the following features:
 - a. The landing shall be at least as wide as the ramp run leading to it.
 - b. The landing length shall be a minimum of 60 inches clear.
 - c. If ramps change direction at landings, the minimum landing size shall be 60 by 60 inches.
4. Handrails. If a ramp run has a rise greater than 6 inches on a horizontal projection greater than 72 inches, then it shall have handrails on both sides. Handrails are not required on curb ramps. Handrails shall have the following features:
 - a. Handrails shall be provided along both sides of ramp segments. The inside handrail on switchback or dogleg ramps shall be continuous.
 - b. If handrails are not continuous, they shall extend at least 12 inches beyond the top and bottom of the ramp segment and shall be parallel with the floor or ground surface.
 - c. The clear space between the handrail and the wall shall be at least 1½ inches.
 - d. Gripping surfaces shall be continuous.
 - e. Top of handrail gripping surfaces shall be mounted between 34 and 38 inches above ramp surfaces.
 - f. Ends of handrails shall be either rounded or returned smoothly to floor, wall or post.
 - g. Handrails shall not rotate within their fittings.
5. Cross Slope and Surfaces. The cross slope of ramp surfaces shall be no greater than 2 percent. Ramp surfaces shall comply with the criteria for “Surface” for sidewalks; see [Section 17.1.7](#).
6. Edge Protection. Ramps and landings with dropoffs shall have curbs, walls, railings or projecting surfaces that prevent people from slipping off the ramp. Curbs shall be a minimum of 2 inches high.
7. Outdoor Conditions. Outdoor ramps and their approaches shall be designed so that water will not accumulate on walking surfaces.

17.1.10 Curb Ramps

Curb ramps and other provisions for the disabled are required on all projects involving the provision of curbs and sidewalks at all intersections.

17.1.10.1 Location

When determining the need for a curb ramp, the designer should consider the following:

1. Intersections. For all projects, include curb ramps at all crosswalks, both marked and unmarked, which provide pedestrian access in that intersection. Also provide curb ramps on all corners.
2. Opposing Ramps. Always provide opposing ramps on adjacent legs of an intersection even if outside project limits.
3. Parked Vehicles. Parking at all curb ramps should be prohibited.
4. Crosswalks. Curb ramps at marked crossings shall be wholly contained within the markings, excluding any flared sides. At intersections where there is no marked crosswalk, place the curb ramp within the area that would reasonably be expected to be used as a crosswalk.
5. Alignment. Curb ramps should be aligned with the crosswalk.
6. Obstructions. The function of the curb ramp must not be compromised by other highway features (e.g., guardrail, catch basins, utility poles, signs).
7. Pedestrian Signals. The location of the curb ramp must be consistent with the operation of pedestrian-actuated traffic signals. In addition, the location of the pedestrian push-button must comply with [Section 17.1.10.3](#).
8. Future Ramps. Curb ramps are required at all curbed intersections with sidewalks.

17.1.10.2 Design

Curb ramps should be constructed of concrete. Examples of curb ramp details can be found in the *Standard Drawings*. All curb ramps should be constructed with detectable warnings devices (i.e., truncated domes); see [Section 17.1.11](#).

17.1.10.3 Crossing Controls

If a pedestrian crosswalk and curb ramp are present at an intersection with a traffic signal that has pedestrian detectors (push buttons), the following will apply:

1. Location. Locate controls as close as practical to the curb ramp and, to the maximum extent feasible, permit operation from a level area immediately adjacent to the controls.
2. Surface. Provide a firm, stable and slip-resistant area, a minimum of 30 by 48 inches, to allow a forward or parallel approach to the controls.
3. Mounting Height. Place pedestrian-actuated crossing controls a maximum of 42 inches above the sidewalk.
4. Controls. Push buttons shall be raised or flush and shall be a minimum of 2 inches in the smallest dimension. The force required to activate controls shall be no greater than 5 pounds.

17.1.10.4 Types

There are two basic types of curb ramps — straight ramps, which include ramps perpendicular and parallel to the roadway, and diagonal ramps. Details for the construction of curb ramps are provided in the *Standard Drawings* and *Standard Specifications*.

The following provides several suggestions for selecting the appropriate curb ramp:

1. Pedestrians Who Are Visually Impaired. Locate the curb ramp so that it will not be a safety hazard for visually impaired pedestrians.
2. Parked Vehicles. Place the curb ramp so that it cannot be obstructed by parked vehicles.
3. Crosswalk Markings and Stop Bars. The placement of the crosswalk affects the placement of the curb ramps. First, determine the desired alignment of the crosswalk. Then, establish the placements of the curb ramps. Consider the following factors when establishing the location for the crosswalk and curb ramps:
 - crosswalk visibility,
 - size of the corner radius,
 - right of way constraints,
 - drainage,

- raised median ends,
- detector loop placement, and
- traffic signal pole locations.

The *MUTCD* provides additional guidance for crosswalk markings and stop bars.

4. Obstructions. The function of the curb ramp must not be compromised by other highway features (e.g., guardrail, catch basins, utility poles, signs). Also, it is desirable to move any obstructions near curb ramps whenever practical. When this is not practical, consider the direction of traffic relative to the placement of the curb ramp. It is important that drivers can see the person using the curb ramp.
5. Diagonal Curb Ramps. Avoid using diagonal curb ramps, especially in new construction. It is preferable to use the straight curb ramp or several straight ramps rather than to use a diagonal curb ramp.
6. Raised Medians. Where raised medians exist within a crosswalk, depress the median to the level of the crosswalk or provide curb ramps on both sides and a minimum level landing area 48 inches long by 30 inches wide.
7. Pedestrian Signals. The location of the curb ramp must be consistent with the operation of pedestrian-actuated traffic signals, if present. In addition, locate the pedestrian push-button so it can be reached by wheelchair-bound individuals.
8. Design Restrictions. For curb ramps on public rights of way routes and where site restrictions (e.g., steeply sloped roadways, constrained right of way) preclude the use of a curb ramp, the designer may use one of the following designs:
 - a. Where the sidewalk longitudinal gradient precludes the installation of a perpendicular curb ramp, a parallel curb ramp, with its gradient measured relative to the sidewalk and street, may be used; see the *Standard Drawings*. The maximum slope shall be 12H:1V. Provide a minimum 60-inch landing area at the bottom of the slope area. The cross slope of the slope area and landing area shall not exceed 2 percent.
 - b. Where installation of a 48-inch landing area on top of the curb ramp or other slope area is impractical, then a 36-inch landing may be provided.
 - c. Another option is to lower the sidewalk to provide a shorter curb ramp distance.
 - d. Where the minimum level landing areas discussed in 8a and 8b cannot be provided, the designer may provide a sloped area connecting to the street crossing with its gradients (i.e., running slope, cross slope, flare slope)

measured from a plane parallel to that of the street; see the *Standard Drawings*. The maximum slope shall be 12H:1V and with a maximum cross slope of 2 percent.

17.1.11 Detectable Warning Surfaces

17.1.11.1 Location

Detectable warning surfaces shall be provided at the following locations:

1. Curb Ramps and Blended Transitions. The detectable warning surface shall be located so the edge nearest to the curb line is 6 inches minimum and 8 inches maximum from the curb line.
2. Rail Crossings. The detectable warning surface shall be 24 inches wide and shall be located so that the edge of the surface nearest the rail crossing is 6 inches minimum and 8 inches maximum from the vehicle dynamic envelope (train sway).
3. Platform Edges. Detectable warning surfaces at platform boarding edges shall be 24 inches wide and shall extend the full length of the platform.

17.1.11.2 Design

Detectable warnings shall consist of a surface of truncated domes aligned in a square grid pattern. The following will apply:

1. Dome Size. Truncated domes in a detectable warning surface shall have a base diameter of 0.9 inch minimum to 1.4 inches maximum, a top diameter of 50 percent of the base diameter minimum to 65 percent of the base diameter maximum, and a height of 0.2 inch.
2. Dome Spacing. Truncated domes in a detectable warning surface shall have a center-to-center spacing of 1.6 inches minimum and 2.4 inches maximum, and a base-to-base spacing of 0.65 inch minimum, measured between the most adjacent domes on a square grid.
3. Contrast. Detectable warning surfaces shall contrast visually with adjacent walking surfaces either light-on-dark or dark-on-light.
4. Size. Detectable warning surfaces shall extend 24 inches minimum in the direction of travel and the full width of the curb ramp, landing or blended transition.

17.2 RETAINING WALLS

Where increasing traffic requires a new roadway or the addition of lanes, retaining systems are often necessary (e.g., where existing or proposed slopes are unstable and flattening of the slope is not feasible). This Section addresses the general requirements in the selection of retaining systems.

For information regarding right of way issues and retaining systems, see [Chapter 30](#).

17.2.1 Selection Process

When selecting a retaining system, the following process will be used:

1. Identify Needs. The Program Manager and the Plan Production Team are responsible for identifying the need for a retaining system (e.g., difference in grade elevations, slope stabilization, limited right of way available, environmental concerns, temporary excavation support, etc.)
2. Identify Site Constraints and Project Requirements. The Structural Engineer, Road/Bridge Design, is responsible for identifying the possible types of retaining systems based on site constraints (e.g., fill conditions, height, right of way constraints, etc.) and project requirements (e.g., time, phasing, environmental issues) provided by the Road Design Squad. The Program Manager is responsible for determining the aesthetic requirements for the wall.
 - a. Functionality. The functionality of a retaining system is dependant on its intended use, and whether it is permanent or temporary. A retaining system that is in use for 5 or more years is considered permanent and its design life is typically 75 or 100 years depending on the critical nature of its use. Retaining systems can be divided further into fill and cut types based on site-specific criteria. Fill types are most appropriate when the location of the retaining system will be “built up” with borrow material to the finished grade. Cut types are most appropriate when the location of the retaining system will be “cut down” to the finished grade. The Structural Engineer is responsible for determining the appropriate retaining system based on its functionality.

- b. Aesthetics. Aesthetic requirements refer to the system's appearance. Aesthetic requirements would include facing, material, color, coping, and possibly layout. The Structural Engineer will assist the Program Manager in developing a list of possible facing options available for the wall. The Program Manager, with assistance from the Environmental Management Office, identifies the aesthetic requirements based on public hearings, communications with property owners, compatibility with other walls on the project and input from the District, and notifies the Structural Engineer of the required facing.
3. Evaluate Alternatives. The Structural Engineer evaluates the alternatives based on the functionality and aesthetic requirements. The Structural Engineer, with the assistance of the Program Manager and Geotechnical Engineer, will conduct a cost analysis for the most appropriate retaining system for the site-specific criteria. The Program Manager will compare other alternatives (e.g., purchasing additional right of way, project realignment, extending bridge structures) to determine the most appropriate option for the project, and notify the Structural Engineer of the chosen option.
4. Geotechnical. Geotechnical Design will order borings based on the possible systems for the site. Geotechnical Design will provide a geotechnical report, geotechnical specifications, and the final recommendation for the retaining system based on the analysis of the borings.
5. Structural. The Structural Engineer will design and detail the retaining system, and will provide design drawings to the Road Design Squad and Geotechnical Design. The Structural Engineer will provide specifications to the Specifications Group of Road Design. Geotechnical Engineers should use the Federal Highway Administration publication, *Geotechnical Engineering Circular No. 2, Earth Retaining Systems* as a guide in selecting the appropriate wall type based on functionality.

PAGE INTENTIONALLY LEFT BLANK

17.3 LANDSCAPING

The following controlling principles are based upon the conservation of natural resources; creating a facility that is compatible with its surroundings; minimizing future management efforts and expenditures; and producing a high quality, environmentally responsible finished product:

1. Environmental Impact. Where practical, avoid adverse or disruptive impacts to landscape and environmental features on or adjacent to the right of way. Where total avoidance of adverse or disruptive impacts is not practical, undertake all reasonable measures to reduce and minimize impacts to these features. If damage or disruption is unavoidable, undertake all reasonable measures to offset damages through mitigation in the project area or other designated areas. Note that the designer cannot recreate or restore natural systems but can utilize native plant materials to represent some of the appearances and functions of the impacted feature (see [Chapter 27](#), Environmental Procedures).
2. Environmentally Sensitive Areas. Consider environmentally sensitive areas and those harboring endangered species to be a controlling factor in all designs.
3. Use of Indigenous Plants. Emphasize the use of plants native to and grown in South Carolina that are appropriate to the site, its planned use and its future management.
4. Site Compatibility. Design a specific landscape that is compatible with the site. This includes design elements that may affect a landscape plan for a specific site (e.g., conduit for electric, water requirements, pipe requirements, vegetation type).
5. Future Management Considerations. Consider the future management plans for the roadside area to be a controlling factor in the planning and design of that area.
6. Sustainable Roadside Environment. Strive to produce a sustainable roadside environment.
7. Visual Quality. Visual appearance and visual unity of the facilities are important components. Recognize that visual quality must be a component in almost all design development and that numerous factors influence the final appearance of the finished project. Durability and appearance are the two items most noticed and commented upon by the traveling public.

Apply landscape and environmentally based design principles to the full range of highway types, from multi-lane freeways to the rehabilitation and improvement of existing local arterials and rural collector roads.

The extent of the application of these principles will depend on the type of project, the environmental resources affected and the public entities involved.

17.4 NOISE CONTROL

17.4.1 General

In response to the problems associated with traffic noise, 23 CFR 772, "Procedures for Abatement of Highway Traffic Noise and Construction Noise," establishes criteria for mitigating highway traffic noise.

Sound pressure levels are used to measure the intensity of sound and are described in terms of decibels. The decibel (dB) is a logarithmic unit that expresses the ratio of the sound pressure level being measured to a standard reference level. Sound pressure level from two equal sources is 3 dB greater than the sound pressure level of just one source. Therefore, two trucks producing 90 dB each will combine to produce 93 dBA, not 180 dBA. This means that a doubling of the noise sources produces only a 3 dBA increase in the sound pressure level. Subjective tests indicate that the human ear is unable to perceive changes in noise levels of less than approximately 2 dBA and it is therefore, barely detectable by the human ear.

Sound intensity decreases in proportion with the square of the distance from the source. Generally, noise levels will decrease by about 6 dBA for each doubling of the distance between the noise source and the affected area.

Special consideration should be given to locations where the noise levels exceed that indicated in [Figure 17.4A](#), shown as a certain dBA level for various types of development areas or where it is predicted that there will be a substantial increase in the ambient noise levels. A 15-dBA increase is considered a "substantial increase" as outlined in the Department's *Noise Abatement Policy*.

Traffic noise can be managed by:

- source control;
- highway design (e.g., modifying the horizontal and vertical geometry);
- traffic volume and traffic mix control (e.g., prohibiting trucks); and
- use of natural or man-made noise barriers.

17.4.2 Definitions

1. Design Year. The future year used to estimate the probable traffic volume for which a highway is designed. A time, 10 to 20 years, from the start of construction is usually used.
2. Existing Noise Levels. The noise, resulting from the natural and mechanical sources and human activity, considered to be usually present in a particular area.

Activity Category	$L_{eq}(h)$ (decibals)	$L_{10}(h)$ (decibals)	Description of Activity Category
A	57 (Exterior)	60 (Exterior)	Lands on which serenity and quiet are of extraordinary significance and serve an important public need and where the preservation of those qualities is essential if the area is to continue to serve its intended purpose.
B	67 (Exterior)	70 (Exterior)	Picnic areas, recreation areas, playgrounds, active sports areas, parks, residences, motels, hotels, schools, churches, libraries and hospitals.
C	72 (Exterior)	75 (Exterior)	Developed lands, properties or activities not included in Categories A or B above.
D	-	-	Undeveloped lands.
E	52 (Interior)	55 (Interior)	Residences, motels, hotels, public meeting rooms, schools, churches, libraries, hospitals and auditoriums.

**Either $L_{eq}(h)$ or $L_{10}(h)$, but not both may be used on a project.*

Note: These sound levels are only to be used to determine impact. These are the absolute levels where abatement must be considered. Noise abatement should be designed to achieve a substantial noise reduction – not the noise abatement criteria.

NOISE ABATEMENT CRITERIA (NAC)
Hourly Weighted Sound Level in Decibels (dBA)*
Figure 17.4A

3. L_{10} . The sound level, in decibels, that is exceeded 10 percent of the time (the 90th percentile) for the period under consideration.
4. $L_{10}(h)$. The hourly value of L_{10} , in decibels.
5. L_{eq} . The equivalent steady-state sound level, in decibels, that in a stated period of time contains the same acoustic energy as a time-varying sound level during the same period.
6. $L_{eq}(h)$. The hourly value of L_{eq} , in decibels.
7. Traffic Noise Impacts. Impacts that occur when the predicted traffic noise levels approach or exceed the noise abatement criteria as shown in Figure 17.4A, or when the predicted traffic noise levels substantially exceed the existing noise

levels. A traffic noise impact occurs when the predicted levels approach or exceed the noise abatement criteria (NAC) or when predicted traffic noise levels substantially exceed the existing noise level, even though the predicted levels may not exceed the NAC.

8. Type I Projects. A proposed Federal or Federal-aid highway project for the construction of a highway on new location or the physical alteration of an existing highway which significantly changes either the horizontal or vertical alignment or increases the number of through-traffic lanes.
9. Type II Projects. A proposed Federal or Federal-aid highway project for noise abatement on an existing highway.

17.4.3 Source Control

As part of Federal legislation, noise emission level criteria have been established for medium and heavy trucks that have a gross vehicle weight rating of more than 5 tons. Maximum noise emission levels are set by the Environmental Protection Agency. For additional information on noise emission levels, see FHWA's, *Highway Traffic Noise Analysis and Abatement Policy and Guidance*.

17.4.4 Highway Design

The road designer should consider various alternatives in the highway design and location in order to minimize excessive noise levels (e.g., altering the horizontal and vertical alignments). Shadow zones can be developed by prudently locating the highway to shield the affected area from the highway noise source. Depressing the highway so that the noise path is deflected upward, out of the depression, or that it passes over the affected areas, can develop shields that create shadow zones. Shielding low-level sites can also be accomplished by elevating the roadway so that the noise path passes over the receptor.

17.4.5 Traffic Mix and Volume

The road designer can control the traffic mix by designating truck routes around sensitive areas. Trucks have been determined to have a greater sound level than passenger cars by approximately 15 dBA. In addition, traffic management measures (e.g., traffic control devices, time-use restrictions, modified speed limits and exclusive land designations) can control the type of traffic and the associated volumes.

17.4.6 Noise Barriers

Properly constructed noise barriers (e.g., earth berms, structural walls) in combination with landscaping whether within or outside the highway right of way can reduce excessive noise levels. Thick dense wooded areas with no visual path between the highway and the affected site can also reduce noise levels. However, trees by themselves do not prove to be a good noise barrier unless they have a very dense mass. Rows of buildings and houses can reduce noise impacts on subsequent rows of buildings and houses.

17.5 BUS STOP AND TURNOUTS

17.5.1 Location

17.5.1.1 Bus Stops

If local bus routes are located on an urban or suburban highway, the designer should consider their impact on normal traffic operations. The stop-and-go pattern of local buses will disrupt traffic flow, but certain measures can minimize the disruption. The location of bus stops is particularly important. These are determined not only by convenience to patrons, but also by the design and operational characteristics of the highway and the roadside environment.

There are three basic bus stop designs — far-side or near-side of an intersection, and mid-block. These designs are shown in [Figure 17.5A](#).

17.5.1.2 Bus Turnouts

Providing bus turnouts can reduce interference between buses and other traffic significantly. Turnouts remove stopped buses from the through lanes and provide a well-defined user area for bus stops. The following provides examples of bus turnouts used by the Department:

1. Far-Side Turnouts. Typically, far-side intersection placement is desirable. Placing turnouts after signal-controlled intersections allows the signal to create gaps in traffic.
2. Near-Side Turnouts. Avoid using near-side turnouts because of conflicts with right-turning vehicles, delays to transit services as buses try to re-enter the traveled way, and obstructions to traffic control devices and pedestrian activities.
3. Mid-Block Turnouts. Only use mid-block turnouts in conjunction with major traffic generators.

17.5.1.3 Selection

In general, far side locations of bus stops and turnouts are preferred. The municipality or local transit authority will determine the location of the bus stop or bus turnout. However, the designer usually has some control over the best placement of a bus stop or turnout location when considering layout details, intersection design and traffic flow patterns.

17.5.2 Design

17.5.2.1 Bus Stops

[Figure 17.5A](#) provides the recommended distances for the prohibition of on-street parking near bus stops.

17.5.2.2 Bus Stop Pads

All new bus stops that are constructed for use with lifts or ramps must meet the disabled accessibility criteria in [Section 17.1](#).

17.5.2.3 Bus Turnouts

Desirably, the total length of a bus turnout will allow for an entrance taper, a deceleration length, a stopping area, an acceleration length and an exit taper. [Figure 17.5B](#) illustrates the design details for bus turnouts. Providing separate deceleration and acceleration lengths are desirable in suburban areas and on rural arterials and may be provided, wherever feasible. However, common practice is to accept deceleration and acceleration in the through lanes and only build the tapers and stopping area.

[Figure 17.5B](#) provides information on taper lengths that may be used for entrance and exit tapers. To improve traffic operations, use short horizontal curves (100-foot radius) on the entry end and 50-foot to 100-foot curves on the re-entry end. Where a turnout is located at a far-side or near-side location, the cross street area can be assumed to fulfill the need for the exit or entry area, whichever applies.

17.5.2.4 Bus Shelters

In general, the municipality or the local transit authority will determine the need for and location of bus shelters. The local transit authority will determine the design of the bus shelter. The designer should insure that the shelter does not restrict vehicular sight distance, pedestrian flow or disabled accessibility.

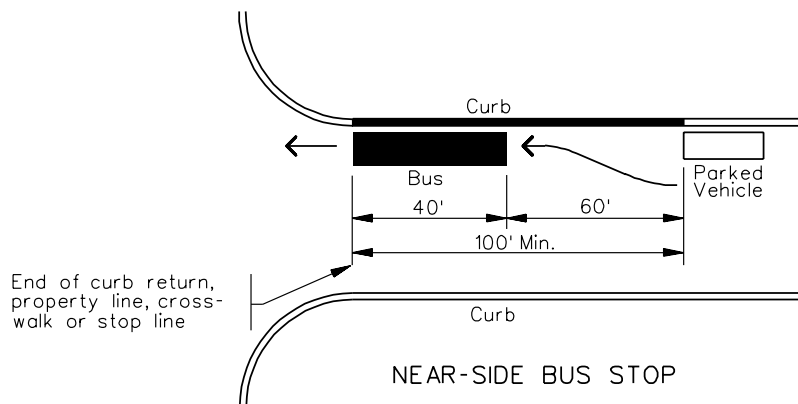
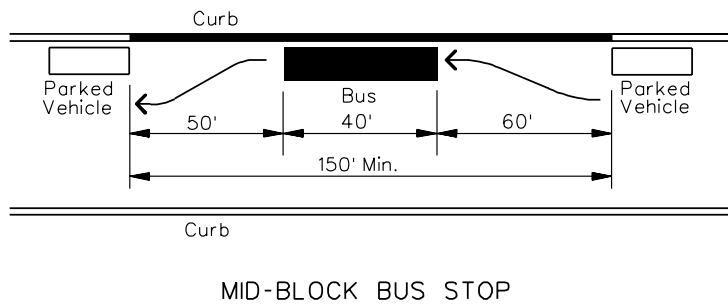
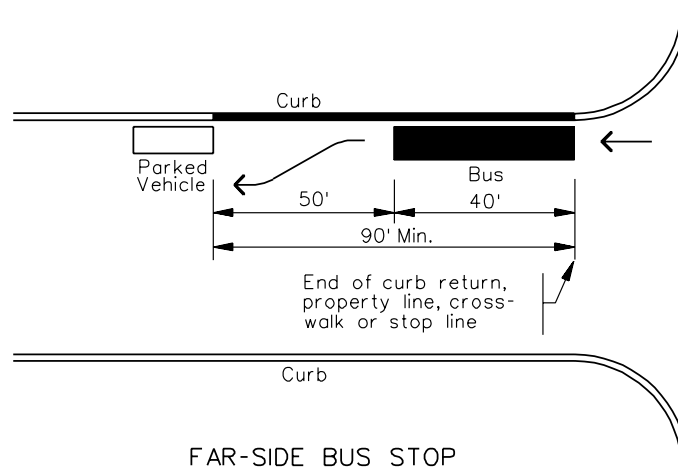

Notes:

1. *Where articulated buses are expected to use these stops, add an additional 20 feet to the bus distances.*
2. *Provide an additional 50 feet of length for each additional bus expected to stop simultaneously at any given bus stop area. This allows for the length of the extra bus, 40 feet, plus 10 feet between buses.*

ON-STREET BUS STOPS

Figure 17.5A

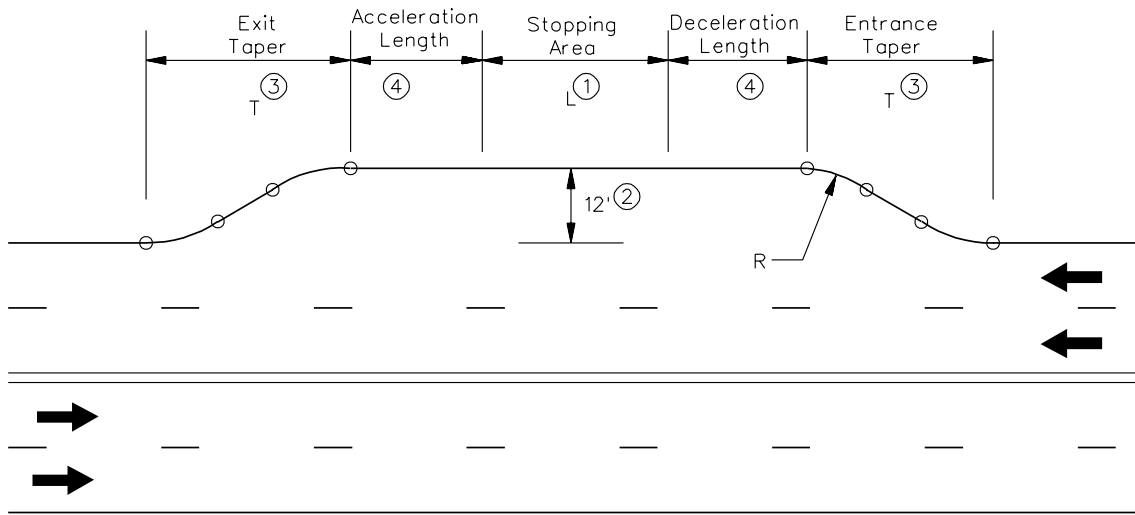

Notes:

- ① Stopping area length consists of 50 feet for each standard 40-foot bus and 70 feet for each 60-foot articulated bus expected to be at the stop simultaneously.
- ② Bus turnout width is desirably 12 feet. For posted speeds under 30 miles per hour, a 10-foot minimum bay width is acceptable. These dimensions do not include gutter width.
- ③ Suggested taper lengths are listed below. A minimum taper of 5:1 may be used for an entrance taper from an arterial street for a bus turnout while the merging or re-entry taper should not be sharper than 3:1.
- ④ The minimum design for a bus turnout does not include acceleration or deceleration lengths. Recommended acceleration and deceleration lengths are listed below.

Design Speed	Entering Speed*	Acceleration Lengths	Deceleration Lengths **	Suggested Taper Lengths
35 mph	25 mph	250 ft	185 ft	170 ft
40 mph	30 mph	400 ft	265 ft	190 ft
45 mph	35 mph	700 ft	360 ft	210 ft
50 mph	40 mph	975 ft	470 ft	230 ft

* Desirably, the bus speed at the end of taper should be within 10 miles per hour of the design speed of the traveled way.

** Based on a 2.5 miles per hour per second deceleration rate.

TYPICAL BUS TURNOUT DIMENSIONS

Figure 17.5B

17.6 MAILBOXES

Mailboxes should be placed with safety considerations for highway traffic, the carrier and the homeowner. The designer should consider the walking distance for the patron, stopping sight distance in advance of the mailbox and sight distance restrictions at intersections and driveways. For additional information on the placement of mailboxes on roadways, see the *AASHTO Roadside Design Guide*.

17.7 REFERENCES

1. *Accessibility Guidelines for Building and Facilities*, U.S. Architectural and Transportation Barriers Compliance Board, 1991, 1994.
2. FHWA-IP-84-6, *Guidelines for Making Pedestrian Crossing Structures Accessible*, FHWA, August, 1984.
3. FHWA-RD-84/082, *Warrants for Pedestrian Over and Underpasses*, 1984.
4. FHWA-SA-96-038, *Geotechnical Engineering Circular No. 2, Earth Retaining Systems*, FHWA, 1996.
5. FHWA-RD-98-13X, *A Quarter Century of Geotechnical Research*, FHWA, 1998.
6. *United States Code of Federal Regulations*, Part 772 "Procedures for Abatement of Highway Traffic Noise and Construction."
7. *Noise Abatement Policy*, SCDOT.
8. *Highway Traffic Noise Analysis and Abatement Policy and Guidance*, FHWA, June 1995.
9. *The Location and Design of Bus Transfer Facilities*, Institute of Transportation Engineers, 1992.
10. *Guidelines for the Location and Design of Bus Stops*, TCRP Report 19, Transportation Research Board, 1996.
11. *A Guide for Erecting Mailboxes on Highways*, AASHTO, 1994.

Chapter Eighteen
RESERVED

Table of Contents

<u>Section</u>	<u>Page</u>
19.1 GENERAL	19.1(1)
19.1.1 Urban Versus Rural Freeways	19.1(1)
19.1.2 Design Studies	19.1(2)
19.2 DESIGN ELEMENTS	19.2(1)
19.2.1 Traffic	19.2(1)
19.2.1.1 Traffic Volume	19.2(1)
19.2.1.2 Level of Service (LOS)	19.2(1)
19.2.2 Design Speed	19.2(1)
19.2.3 Alignment	19.2(1)
19.2.4 Sight Distance	19.2(3)
19.2.5 Cross Sections	19.2(3)
19.2.5.1 Lane and Shoulder Widths	19.2(3)
19.2.5.2 Typical Sections	19.2(4)
19.3 TABLES OF DESIGN CRITERIA	19.3(1)
19.4 INTERCHANGES/GRADE SEPARATIONS	19.4(1)
19.4.1 Interchanges	19.4(1)
19.4.2 Grade Separations	19.4(1)
19.4.2.1 Justification	19.4(1)
19.4.2.2 General Design Considerations	19.4(3)
19.4.2.3 Underpass Roadway	19.4(6)
19.5 MISCELLANEOUS ELEMENTS	19.5(1)
19.5.1 Freeway Lane Drops	19.5(1)
19.5.2 Weaving	19.5(3)
19.5.3 Frontage Roads	19.5(3)
19.5.3.1 General	19.5(3)
19.5.3.2 Outer Separations	19.5(4)

Table of Contents

(Continued)

<u>Section</u>		<u>Page</u>
	19.5.3.3 Functional Classification.....	19.5(4)
	19.5.3.4 Design	19.5(4)
	19.5.4 Pedestrians	19.5(6)
	19.5.5 Noise Barriers.....	19.5(6)
19.6	REFERENCES.....	19.6(1)

Chapter Nineteen

FREEWAYS

19.1 GENERAL

Freeways are functionally classified as Principal Arterials and are constructed with full control of access. Freeways are intended to provide high levels of safety and efficiency in moving high volumes of traffic at high speeds. The operational efficiency, capacity, safety and cost of the highway facility are largely dependent upon its design. Rural freeways are connecting roadway links between major cities, towns and urban areas. Similarly, urban freeways provide service for large volumes of traffic within and through urbanized areas. This Chapter provides guidance in the design of rural and urban freeways including specific design criteria, frontage roads, lane drops, justification for grade separations, access control along the freeway and safety. Additional information that is applicable to freeways is also included in the following chapters:

[Chapter 9](#) provides guidelines for access control along interchange crossroads. It also discusses the procedures for depicting control of access in the Plans.

[Chapters 9, 10, 11, 12](#) and [13](#) provide guidance on the geometric design elements.

[Chapter 14](#) provides guidelines on roadside safety issues.

[Chapter 16](#) discusses the type, location and design of interchanges.

19.1.1 Urban Versus Rural Freeways

Urban and rural freeways are similar in that they are intended to provide safe, rapid and high-quality transportation facilities for motorists. The primary difference between rural and urban freeways is in the concept of operational freedom. Motorists on rural freeways expect more operational freedom and greater travel speeds than urban motorists.

Urban freeways are designed to carry large traffic volumes and have multilanes in each direction. Typically, urban freeways have two lanes in each direction, and can be designed for six or more lanes. Urban freeways take many forms (e.g., depressed, ground level, elevated embankment, elevated viaduct or a combination). In most instances, right of way restrictions cause designers to evaluate alternatives so that socio-economic factors, right of way and construction costs are considered.

Rural freeways are similar in design to urban ground level freeways. Designers must consider the differences between rural and urban freeways when applying freeway design criteria to a project.

19.1.2 Design Studies

Freeway design considerations evolve around traffic volumes, design speed and level of service. These are the primary factors that either individually or collectively are instrumental in governing the selection of appropriate roadway geometric criteria and/or cross section elements in the design of freeways. When developing a freeway alignment, first determine the location and type of interchanges. Then develop the freeway alignment between the interchanges. Other factors that may influence the freeway alignment include:

- the location of grade separations, including major river crossings;
- access control along the freeway and along interchange crossroads;
- topography;
- environmental restrictions; and
- property lines and right of way restrictions.

19.2 DESIGN ELEMENTS

19.2.1 Traffic

19.2.1.1 Traffic Volume

Traffic volumes are a major consideration in justifying highway facilities and assisting designers in the establishment of preliminary geometric and cross section design characteristics. Future 20-year projected traffic volumes are used in determining design elements of urban and rural freeways.

19.2.1.2 Level of Service (LOS)

The LOS consideration in the design of freeways is based on traffic volumes. Because LOS is a measure of the freedom of movement and operational delays for traffic, it is appropriate that freeways are designed to operate at a high LOS.

Rural freeways should be designed to operate at a LOS B. LOS B is in the stable traffic flow range in which the motorist's freedom to select the desired operating speed is relatively unaffected and motorist freedom of maneuvering is only slightly restricted. In rural mountainous terrain, it may be necessary to reduce the design to LOS C in which the ability to maneuver within the traffic stream becomes increasingly affected by the presence of other vehicles. Further discussion on the LOS design concept is included in [Section 9.6.4.1](#).

For urban freeways, a LOS C is desirable, but in some cases it may not be economically feasible.

19.2.2 Design Speed

Freeways are intended to accommodate high-speed traffic. Urban and rural freeways should have design speeds between 65 and 75 miles per hour. In mountainous terrain, rural freeway design speeds may be reduced to 55 miles per hour. For urban freeways, limited right of way, high construction costs and social or environmental concerns may suggest a lower design speed. Urban freeway design speeds should be no lower than 55 miles per hour to maintain an overall high quality, smooth-flowing and safe facility.

19.2.3 Alignment

Designed for high-volume and high-speed operations, freeways should have smooth horizontal and vertical alignments. Proper combinations of curvature, tangents, grades, variable median widths and separate roadway elevations all combine to enhance safety

and aesthetics of freeways. When designing freeway alignments, consider the following guidelines:

1. Horizontal Alignment. The following guidelines should be applied when laying out the horizontal alignment:
 - Use large radius curves.
 - Only use minimum radii where it is necessary due to restricted conditions.
 - Avoid alignments that require superelevation transitions on bridges or bridge approach slabs.
2. Vertical Alignment. Even though the profile may satisfy all design controls, the use of minimum criteria may appear forced and angular. Therefore, use higher values to produce a smoother, more aesthetically pleasing alignment keeping in mind that curves which are too flat will produce flat areas that may cause drainage problems.
3. Horizontal and Vertical Combinations. Consider the relationship between horizontal and vertical alignments simultaneously to obtain a desirable condition. [Section 12.2.2](#) discusses this relationship in detail and its effect on aesthetics and safety.
4. Freeway River Crossings. During the development of freeways, the alignment may need to cross major rivers, streams or bays. In selecting the location for a bridge site, consider the following guidelines:
 - a. Crossing Angle. Cross the river at a nearly right angle to minimize the length of the main span.
 - b. Bluffs. If a bluff exists adjacent to the river, attempt to locate one of the abutments on a bluff closest to the river. This will minimize the overall length of the bridge and, therefore, reduce the cost of the structure.
 - c. River Bends. Avoid locating the bridge on a bend in the river. Locating a bridge on a bend may result in unnecessarily long spans and may increase the chance of ships and boats colliding with the main bridge piers.
 - d. Freeway Alignment. Examine how the freeway alignment will tie into the ends of the bridge. Approach horizontal and vertical alignments can significantly improve the aesthetics of the bridge location. Make every effort to avoid placing horizontal curves and superelevation transitions on the bridge.

- e. Foundation Conditions. Investigate the soil conditions at each bridge abutment and the depth of bedrock at each pier location. Poor foundation conditions may limit possible bridge sites.
 - f. Existing Structures. Existing structures may limit the location of a new bridge. Provide sufficient separation between structures.
 - g. Environmental Considerations. Avoid or minimize the impact on environmentally or historically sensitive areas wherever practical in conjunction with the above guidelines.
5. Interchanges. When developing the alignment and profile of freeways near proposed interchanges, see [Chapter 16](#) for detailed guidelines.
 6. Climbing Lanes. [Section 12.4](#) discusses the warrants and design criteria for climbing lanes. For most freeways, climbing lanes are not warranted unless a drop in the level of service is significant.

19.2.4 Sight Distance

Sight distances for freeways should desirably be provided based upon the decision sight distance in areas where driver confusion may occur (e.g., within interchanges, changes in cross sections, lane drops).

See [Chapter 10](#) for additional information on sight distance.

19.2.5 Cross Sections

19.2.5.1 Lane and Shoulder Widths

The minimum lane widths on freeways should be 12 feet. The inside shoulder should be 10 feet and the outside shoulder should be 12 feet. Where reduced shoulder widths are provided, consider incorporating the following:

- adding advisory and regulatory signing,
- additional raised pavement markings,
- constructing frequent emergency pull-outs,
- using changeable overhead message signs,
- providing continuous lighting,
- incorporating truck-lane restrictions, and/or
- setting up dedicated service patrols and other incident management measures.

For more information on cross section design elements, see [Section 13.2](#).

19.2.5.2 Typical Sections

Figures 19.2A through 19.2C illustrate typical cross-sections for various freeway designs. Figure 19.2A provides a typical section for a rural/urban four-lane divided freeway with a depressed median. Figures 19.2B and 19.2C provide typical sections for an urban freeway with concrete median barriers (CMB).

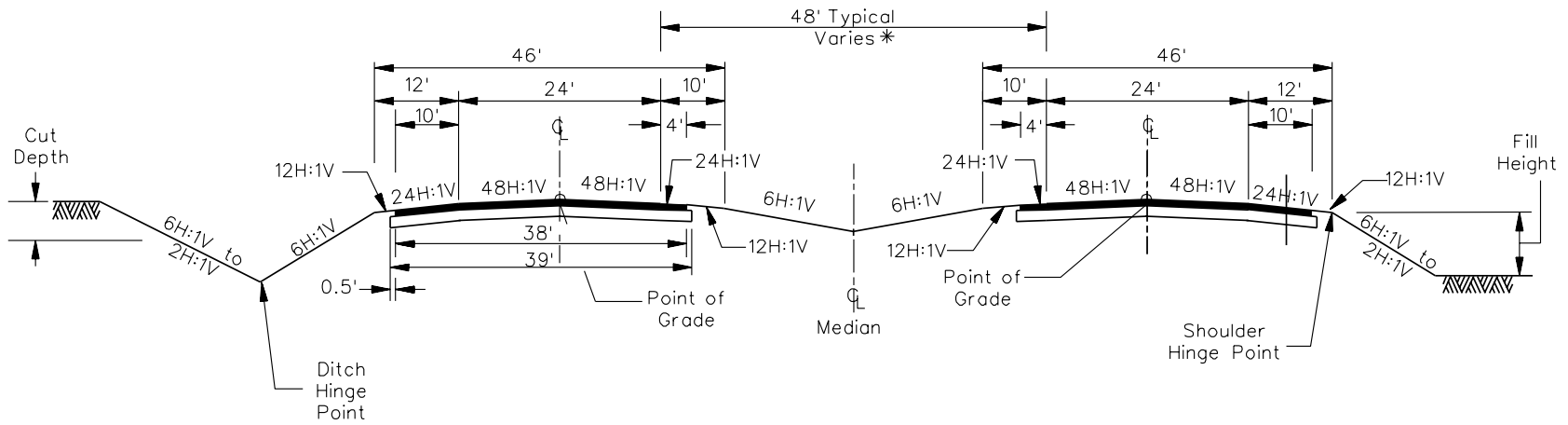

*In rural areas a wider median may be desirable to accommodate future widening.

*In rural areas, a wider median may be desirable to accommodate future widening.

**TYPICAL RURAL/URBAN FOUR-LANE DIVIDED FREEWAY
(Depressed Median)**

Figure 19.2A

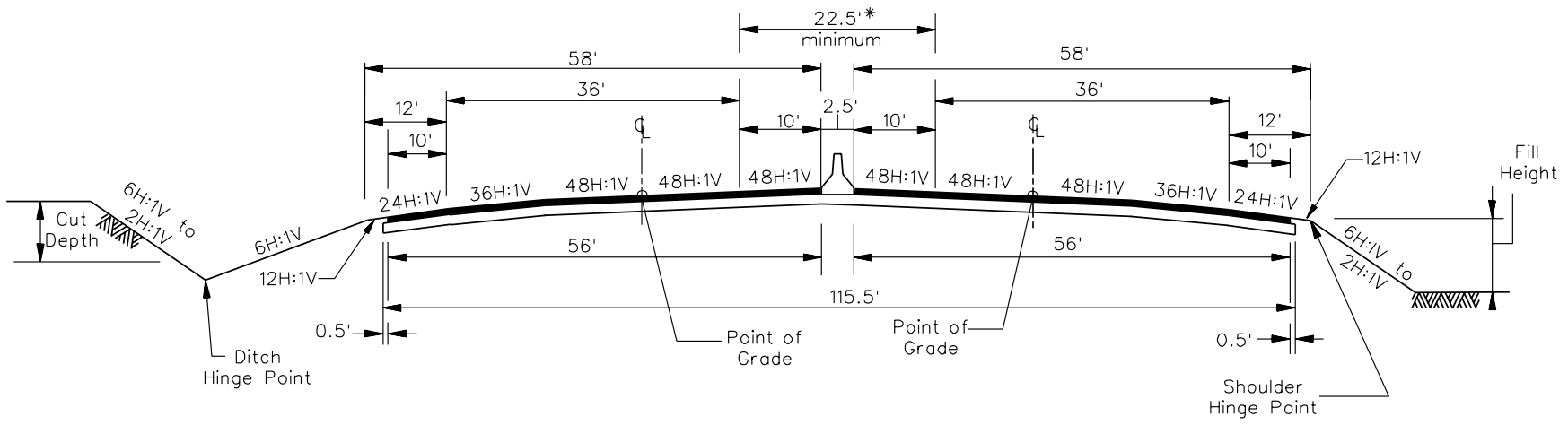

* Where adding travel lanes to an existing median less than 48 feet, the left - shoulder width may be less than 10 feet.

**TYPICAL RURAL/URBAN SIX-LANE DIVIDED FREEWAY
(CMB Median)
Figure 19.2B**

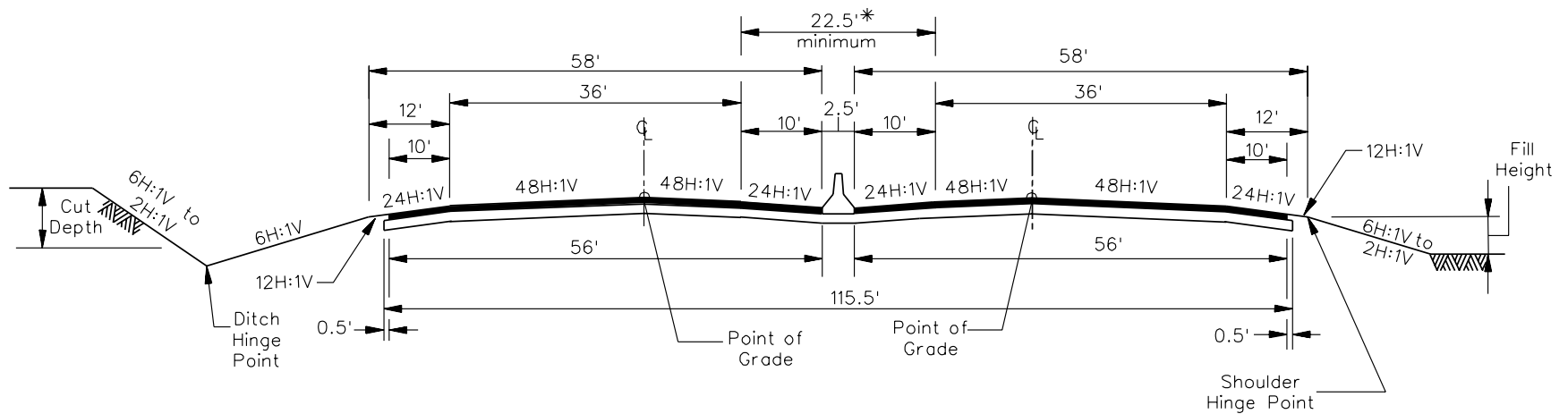

* Where adding travel lanes to an existing median less than 48 feet, the left - shoulder width may be less than 10 feet.

**TYPICAL RURAL/URBAN SIX-LANE DIVIDED FREEWAY
(CMB Median)
Figure 19.2C**

19.3 TABLES OF DESIGN CRITERIA

Figures 19.3A and 19.3B present the Department's design and alignment criteria for freeway projects. The designer should consider the following when using these figures:

1. Applicability. Note that some of the cross-section elements included in the figures (e.g., flush CMB) are not automatically warranted in the project design. The values in the figures only apply after the decision has been made to include the design element in the highway cross section.
2. Manual Section References. These figures are intended to provide a concise listing of design values for easy use. However, the designer should review the *Manual* section references for more information on the design elements.
3. Footnotes. The figures include many footnotes, which are identified by a number in parentheses (e.g., (3)). The information in the footnotes is critical to the proper use of the design tables.
4. Controlling Design Criteria. The figures provide an asterisk to indicate controlling design criteria. If the designer cannot meet the criteria provided in the tables, see the Program Manager for alternatives. Section 9.2 discusses this in more detail and presents the process for approving design exceptions to controlling criteria.

Design Element			Manual Section	Rural	Urban	
Design Controls	Design Forecast Year		9.6.2	20 Years	20 Years	
	*Design Speed	Minimum	9.5.2	70 mph (1)	50 mph	
	Access Control		9.8	Full Control	Full Control	
	Level of Service	Desirable	9.6.4	B	C	
Minimum		C		D		
Cross Section Elements	*Travel Lane Width		13.2.3	12'	12'	
	*Shoulder Width	Right	Total Width	13.2.4	12'	12'
			Paved		10' (2)	10' (2)
		Left	Total Width		10'	10'
			Paved		4' (3)	4' (3)
	Auxiliary Lanes	Lane Width		13.2.5	12'	12'
		Shoulder Width	Total Width		12'	12'
			Paved		10'	10'
	Cross Slope	*Travel Lane		13.2.3.3	2.08% (4)	2.08% (4)
		Auxiliary Lane		13.2.5	2.08% (5)	2.08% (5)
		*Shoulder	Paved	13.2.4.3	4.17%	4.17%
			Unpaved		8.33%	8.33%
Median Width	Depressed		13.4.2.3	Min.: 48'	48' (6)	
	Flush (CMB)		13.4.2.1	Min.: 22.5'	Min.: 22.5' (7)	
Roadway Slopes	Side Slopes	Cut Section	13.3.1	Foreslope	6H:1V	6H:1V
				Ditch Type	V-Ditch	V-Ditch
				Back Slope	6H:1V to 2H:1V	6H:1V to 2H:1V
				Rock Cut	0.25H:1V (8)	0.25H:1V (8)
		Fill Section		0' – 5': 6H:1V; 5' – 10': 4H:1V; > 10': 2H:1V		
	Median Slopes			13.4.2	6H:1V	6H:1V
Clear Zone				14.3	(9)	(9)
Bridges	New and Reconstructed Bridges	*Structural Capacity			HL-93	HL-93
		*Clear Roadway Width		13.5.1.1	(10)	(10)
	Existing Bridges to Remain in Place	*Structural Capacity			HS-20	HS-20
		*Clear Roadway Width		13.5.1.1	(11)	(11)
	*Vertical Clearance (Freeway Under) (12a)	New/Replaced Overpassing Bridges (12b)		12.6	17'-0"	17'-0"
		Existing Overpassing Bridges			16'-0"	16'-0"
		Pedestrian Bridges			18'-0"	18'-0"
		Overhead Signs			17'-6"	17'-6"
	Clearance (Freeway Over)	*Railroads		12.6	23'-0"	23'-0"
Underpass Width		13.5.2	Traveled Way plus Clear Zone	Traveled Way plus Clear Zone		

*Controlling design criteria (see Section 9.2)

GEOMETRIC DESIGN CRITERIA FOR FREEWAYS (New Construction/Reconstruction)

Figure 19.3A

GEOMETRIC DESIGN CRITERIA FOR FREEWAYS (New Construction/Reconstruction)

Footnotes to [Figure 19.3A](#)

- (1) Design Speed. In mountainous terrain, a minimum design speed of 55 miles per hour may be considered.
- (2) Shoulder Width (Right). Where the directional distribution of trucks exceeds 250 DDHV, consider providing a 12-foot paved shoulder.
- (3) Shoulder Width (Left). Where there are three or more lanes in one direction, provide a 10-foot left paved shoulder. If the directional distribution of trucks exceeds 250 DDHV, consider providing a 12-foot paved left shoulder.
- (4) Travel Lane Cross Slope. On a six-lane highway crowned at the center line with CMB, use 2.08 percent for first two travel lanes adjacent to inside shoulder, use 2.78 percent for third lane breaking away from outside edge of second travel lane. See [Figure 19.2B](#).
- (5) Auxiliary Lane Cross Slope. For auxiliary lanes adjacent to two travel lanes sloped in the same direction, use a cross slope of 2.78 percent.
- (6) Depressed Median Widths. In urban areas, existing 36-foot medians may be allowed to remain in place.
- (7) Flush Median Widths (CMB). In urban areas, existing 12-foot to 14-foot medians may be allowed to remain-in-place. Where adding travel lanes to an existing median less than 48 feet, the left-shoulder may be less than 10 feet.
- (8) Side Slopes (Cut Section). Cut rock slope may vary based on a detailed geotechnical investigation.
- (9) Clear Zone. The clear zone will vary according to design speed, traffic volumes, side slopes and horizontal curvature.
- (10) New and Reconstructed Bridge Widths. Clear roadway bridge widths are measured from face to face of parapets or rails. Bridge widths are normally defined as the sum of the approach traveled way width plus total shoulder width right and left.
- (11) Existing Bridge Widths to Remain in Place. Clear roadway bridge widths are measured from face to face of parapets or rails. Bridge widths are normally defined as the sum of the approach traveled way width plus total shoulder width right and left.
- (12) Vertical Clearance (Freeway Under).
 - a. The clearance must be available over the traveled way, shoulders, and any anticipated future widening.
 - b. Table value includes allowance for future overlays.

Design Element	Manual Section	Design Speed					
		75 mph	70 mph	65 mph	60 mph	55 mph	
* Stopping Sight Distance (1)	10.1	820'	730'	645'	570'	495'	
* Minimum Radii ($e_{max} = 8\%$)	11.2.3	2215'	1820'	1485'	1205'	965'	
* Superelevation Rates	11.3	8%	8%	8%	8%	8%	
* Horizontal Sight Distance	11.4	38'	36'	35'	34'	32'	
* Vertical Curvature (2) (Minimum K-values)	12.5	Crest	312	247	193	151	114
		Sag	206	181	157	137	115
* Maximum Grade (3)	12.3.1	Level	3%	3%	3%	3%	4%
		Rolling	4%	4%	4%	4%	5%
		Mountainous	N/A	5%	5%	6%	6%
Minimum Grade (4)	12.3.2	Desirable: 0.5% Minimum: 0.0%					

* Controlling design criteria (see [Section 9.2](#)).

- (1) Stopping Sight Distance. Table values are for passenger cars on level grade.
- (2) Vertical Curvature. The K-values are based on stopping sight distances. See [Section 19.2.4](#).
- (3) Maximum Grade.
 - a. Rural. With wide medians where two roadways are on independent alignments, downgrades may be 1 percent steeper.
 - b. Urban. Grades 1 percent steeper may be used for restricted conditions.
- (4) Minimum Grade. Check flow lines of the outside ditches to insure adequate drainage.

ALIGNMENT CRITERIA FOR FREEWAYS (New Construction/Reconstruction)

Figure 19.3B

19.4 INTERCHANGES/GRADE SEPARATIONS

Where there is a need to provide for the safe and efficient movement of traffic through a series of intersecting roads, it can most effectively be accomplished by providing grade separations and/or interchanges. This allows for the greatest capacity and level of service that can be achieved by providing continuous uninterrupted travel for highway users. On fully access-controlled facilities, each intersecting highway must be terminated, rerouted or provided with a grade separation or interchange. The importance of the continuity of the crossing road, the feasibility of alternative routes, traffic volumes, construction costs, environmental impacts, etc., must be evaluated to determine which option is the most cost effective.

19.4.1 Interchanges

[Section 16.2](#) discusses several guidelines that must be considered in determining whether or not an interchange should be provided. In general, interchanges are provided at all freeway-to-freeway crossings and other major highways based on the anticipated demand for regional access.

[Section 16.2](#) also discusses the procedures for adding or revising an interchange access point to the freeway system.

19.4.2 Grade Separations

Grade separations are provided to allow for two transportation facilities to cross at different elevations (e.g., highways, railroads, pedestrian crossings, bicycle paths). Separations are defined in terms of the major highway crossing over (overpass) or under (underpass) the less major facility.

The type of bridge structure provided at overpasses and underpasses is based upon site conditions and span lengths required to obtain the necessary horizontal and vertical clearances.

19.4.2.1 Justification

For each crossroad along the freeway, which is not an interchange, a determination must be made whether the crossroad should be closed, rerouted or provided with a grade separation. Primarily comparing the respective cost and social factors for each alternative makes this justification. Although cost is a primary factor, the designer should review the following additional considerations:

1. Operations. Grade separations should be of sufficient number and adequate capacity to accommodate the crossroad traffic, traffic diverted to crossroads from

- other roads and streets terminated by the freeway and the traffic generated by access connections to and from the mainline.
2. Locations. The location of grade separation structures is determined by assessing the need to provide for community and commercial continuity and traffic demand.
 3. Site Topography. There are some sites where existing topography creates a condition in which the only rational design approach is to provide for grade separations.
 4. Local Considerations. Closing the crossroad can have a significant impact on local users and the overall local road system integrity due, primarily, to changes in travel patterns. These may include:
 - a. School Bus Routes. The effect of a road closure on the bus route system can be two-fold. There may be an increase in the operating cost due to longer bus routes and an increase in the travel time for school children.
 - b. Emergency Personnel. The financial effect of the longer detour route on emergency vehicles is generally not a concern. However, the extra response time could adversely affect the health and safety of local citizens.
 - c. Businesses/Farms. Access to businesses and farms must be evaluated to insure that these operations can continue without severe economic hardship. For businesses, the road closure can significantly affect their deliveries and the number of customers they receive (e.g., customers may be unwilling to travel the extra distance). For farmers, the road closure may require the transportation of large, slow-moving farm equipment along busy alternative facilities.
 - d. Social Factors. Parks, churches, cemeteries, public facilities, and other areas or buildings of social concern generally cannot be relocated. Limited access to these facilities may create undue hardship.
 - e. Land Use Planning. Consider future land use within a suburban environment to insure adequate access and reciprocation factors are available.

When interchanges cannot be justified by traffic demands and economics, grade separations along freeways may be provided when the following conditions are met:

- decrease in traffic and/or road user costs,
- route continuity,
- when the intersecting road cannot be cost effectively re-routed through the use of frontage or other local roads,

- a critical need exists to maintain local access, and
- a critical need exists at railroad crossings for safety or special crossings for pedestrians or bicycle users.

19.4.2.2 General Design Considerations

Often the proposed highway grade separation (i.e., carrying the mainline over or under the crossroad) is based on topography features or highway classification. When designing grade separations, consider the following guidelines:

1. Over versus Under. The decision on whether the freeway should be over or under the crossroad is normally dictated by topography and cost. If the topography does not favor one profile over the other, use the following guidelines to decide which highway should cross over the other:
 - a. Cost Effectiveness. The designer should consider which alternative will be more cost effective to construct. Some elements to consider are the amount of embankment and excavation required, span lengths, angle of skew, gradients, sight distances, alignment, vertical clearances, constructability, traffic control, right of way, access, drainage, soil conditions and construction costs.
 - b. Classification. Select the alternative that provides the highest design for the mainline road. Typically, the crossroad has a lower design speed and, therefore, the minor road can be designed with steeper gradients, lesser roadway widths, steeper side slopes, etc.
 - c. Future Crossings. If any crossings and/or structures are planned for a future date, the mainline should be under these future crossings. Overpasses are easier to install and will be less disruptive to the freeway when they are constructed in the future.
 - d. Aesthetics. Through traffic is given aesthetic preference by a layout in which the more important road is the overpass. A wide overlook can be provided from the structure and its approaches, giving drivers a minimum feeling of restriction.
 - e. Turning Traffic. Where turning traffic is significant, the ramp profiles are best fitted when the major road is at the lower level. The ramp grades then assist turning vehicles to decelerate as they leave the major highway and to accelerate as they approach it. In addition, for diamond interchanges, the ramp terminal is visible to drivers as they leave the major highway.

2. Horizontal Distance. The distance required for adequate design of a grade separation depends on the design speed, the roadway gradient and the amount of rise or fall necessary to affect the separation. [Figure 19.4A](#) can be used during preliminary design to quickly determine whether a grade separation is feasible for a given set of conditions, what gradients may be involved and what profile adjustments may be necessary on the crossroad. Also, carefully study the sight distance requirements because these will often dictate the required horizontal distance along the crossroad. When using [Figure 19.4A](#), consider the following:
 - a. Minimum Horizontal Distances. The plotted lines on [Figure 19.4A](#) are derived assuming the same approach gradient on each side of the structure. However, values of “D” from the figure also are applicable to combinations of unequal gradients. Distance “D” is equal to the length of the initial vertical curve, plus one-half the central vertical curve, plus the length of tangent between the curves. Lengths of vertical curves are based on stopping sight distances. However, longer vertical curves are desirable from an aesthetic and safety standpoint. Conversely, longer curve lengths may be costlier due to increased earthwork quantities. However, these additional costs may be a less important consideration if crossroads or access points exist near the grade separation structure.
 - b. Maximum Gradient. The lower terminal point of each gradient line on [Figure 19.4A](#), marked by a small symbol, indicates the distance where the tangent between the curves is zero and below which a design for the given grade is not feasible (i.e., a profile condition where the minimum central and end curves for the gradient would overlap).
 - c. Restricted Gradients. For the usual profile rise or fall required for a grade separation (“H” of 25 feet or less), do not use gradients greater than 3 percent for a design speed of 70 miles per hour, 4 percent for 60 miles per hour, 5 percent for 50 miles per hour and 6 percent for 40 miles per hour. For values of “H” less than 25 feet, use flatter gradients.
 - d. Relationship. For a given “H” and design speed, distance “D” is only shortened a negligible amount by increasing the gradient. However, the distance “D” varies to a greater extent for a given “H” and “G” with respect to the design speed.
 - e. Elevation. Considering the vertical clearance and structural depth, an elevation distance of “H” is typically between 23 and 25 feet for the grade separation of two highways. “H” is typically the same for a freeway under a railroad. For a railroad facility under a freeway, “H” is typically 30 to 31 feet.

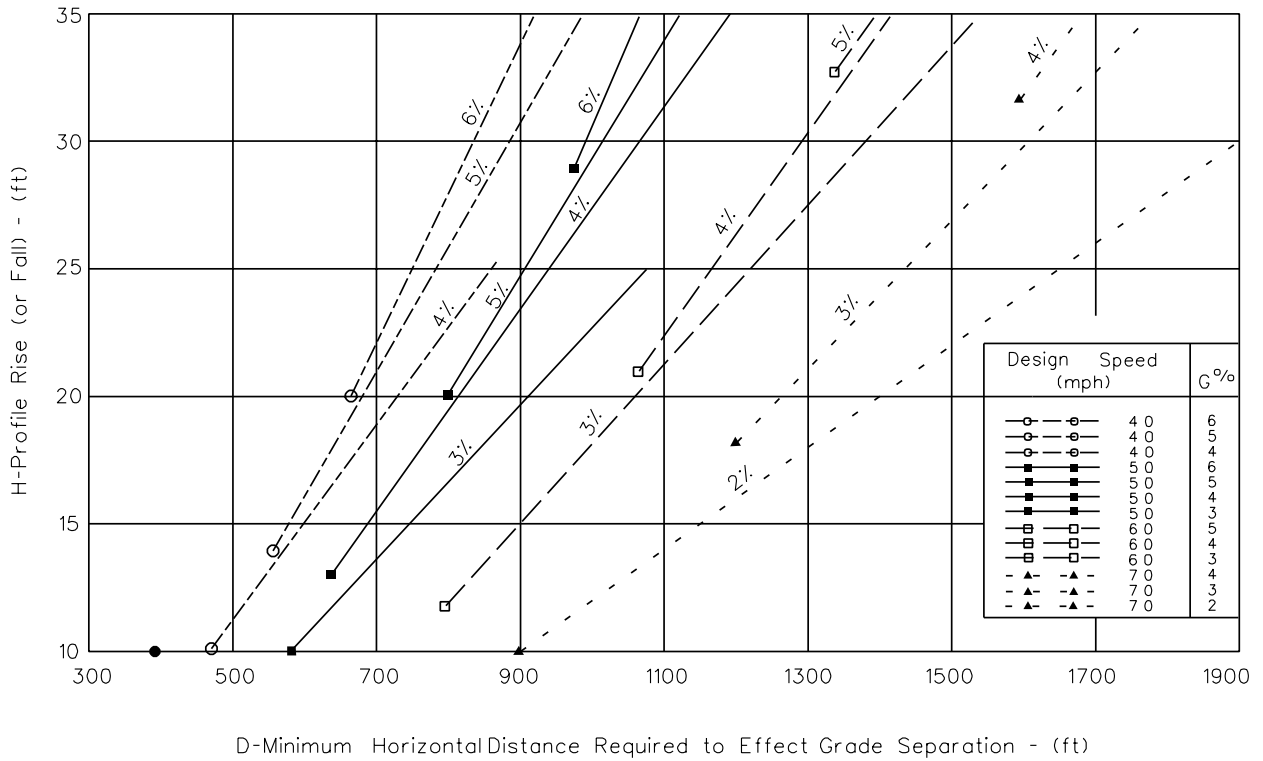

Note: Symbols on ends of lines indicate the point below which the grade is not feasible, necessitating the use of next flatter curve.

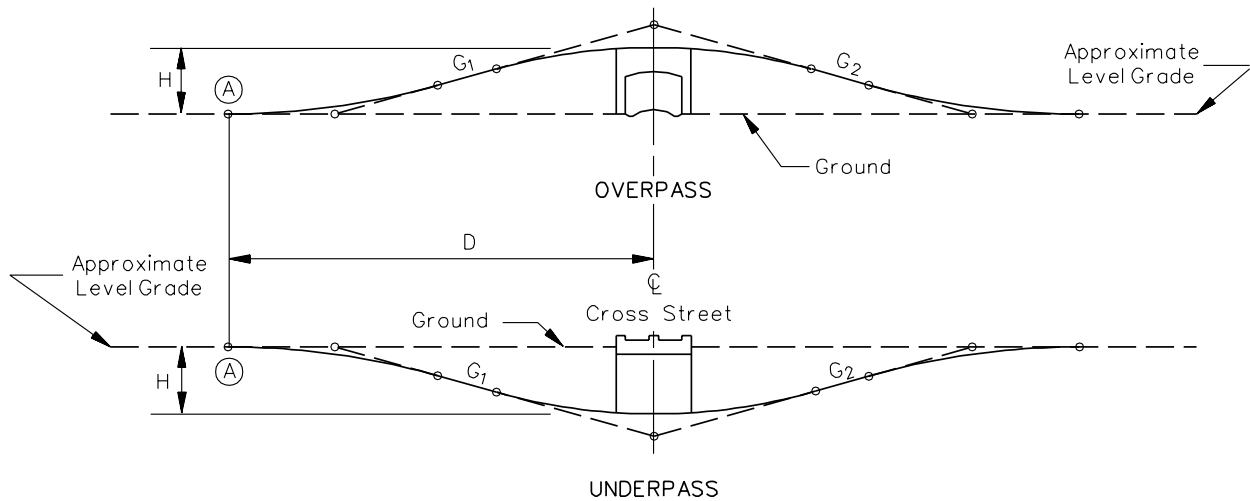

GRADE SEPARATION DETERMINATION

Figure 19.4A

- f. Design Speed. To provide additional safety at rural grade separations where the crossroad passes over the freeway, consider designing the crest vertical curve with a design speed of 55 miles per hour or greater.
3. Sight Distance. In rolling topography or in rugged terrain, major-road overcrossings may be attainable only by a forced alignment and rolling gradeline. Where there is no pronounced advantage to the selection of either an underpass or an overpass, the design that provides the better sight distance on the major road (desirably passing distance if the crossroad is two lanes) should be preferred.
4. Hydrology Considerations. Carrying the major highway over without altering the crossroad grade may reduce troublesome drainage problems. In some cases, the drainage problem alone may be sufficient reason for choosing to carry the major highway over rather than under the crossroad.

* * * * *

Example 19.4(1)

It is proposed that an existing crossroad be provided with an overpass over a new freeway.

Given: Crossroad Design Speed – 50 miles per hour.
Difference between the proposed crossroad profile grade line and the proposed freeway profile grade line is 25.0 feet.

Problem: Determine where along the crossroad the profile grade line will need to be adjusted to provide a 25-foot profile rise.

Solution: Assume a longitudinal gradient of 4 percent. Reading into [Figure 19.4A](#), the minimum distance required to provide the 25-foot height distance is approximately 940 feet. Note that when using a 5 percent longitudinal gradient the distance will be approximately 900 feet.

* * * * *

19.4.2.3 Underpass Roadway

For each underpass, the dimension, load, foundation and general site needs should determine the type of structure used for that particular location. Only the dimensional details are reviewed in this Section.

An underpass is only one component of the total facility and should be consistent with the design criteria of the rest of the facility to the extent practical. It is desirable that the entire roadway cross section, including the median, traveled way, shoulders and

roadside clear zone areas, be maintained through the structure. Possible limitations may require some reduction in the basic roadway cross section (e.g., structural design limitations, lateral clearance limitations, controls on grades and vertical clearance, limitations due to skewed crossings, appearance or aesthetic dimension relations, cost factors). However, where conditions permit a substantial length of freeway to be developed with desirable lateral dimensions, an isolated overpass along the section should not be designed as a restrictive element. In these cases, the additional structural costs are strongly encouraged to insure consistency throughout the facility.

Desirable lateral clearances for freeway underpasses are illustrated in [Figure 19.4B](#). For a two-lane roadway or an undivided multilane roadway, the cross section width at underpasses will vary, depending on the design criteria appropriate for the particular functional classification and traffic volume. The minimum lateral clearance from the edge of the traveled way to the face of the protective barrier should be the normal shoulder width.

On divided highways, the clearances on the left side of each roadway are usually governed by the median width and clear zone. For a roadway with six or more lanes, the minimum median width should be 22.5 feet to provide 10-foot shoulders and a CMB. [Figure 19.4C\(a\)](#) shows the minimum lateral clearances to a continuous median barrier for the basic roadway section and for an underpass where there is no center support. The same clearance dimensions are applicable for a continuous wall on the left.

[Figure 19.4C\(b\)](#) shows the minimum lateral clearance on the right side of the roadway as applicable to a continuous wall section. For this situation, the lateral clearance on the right should be measured to the base of the barrier.

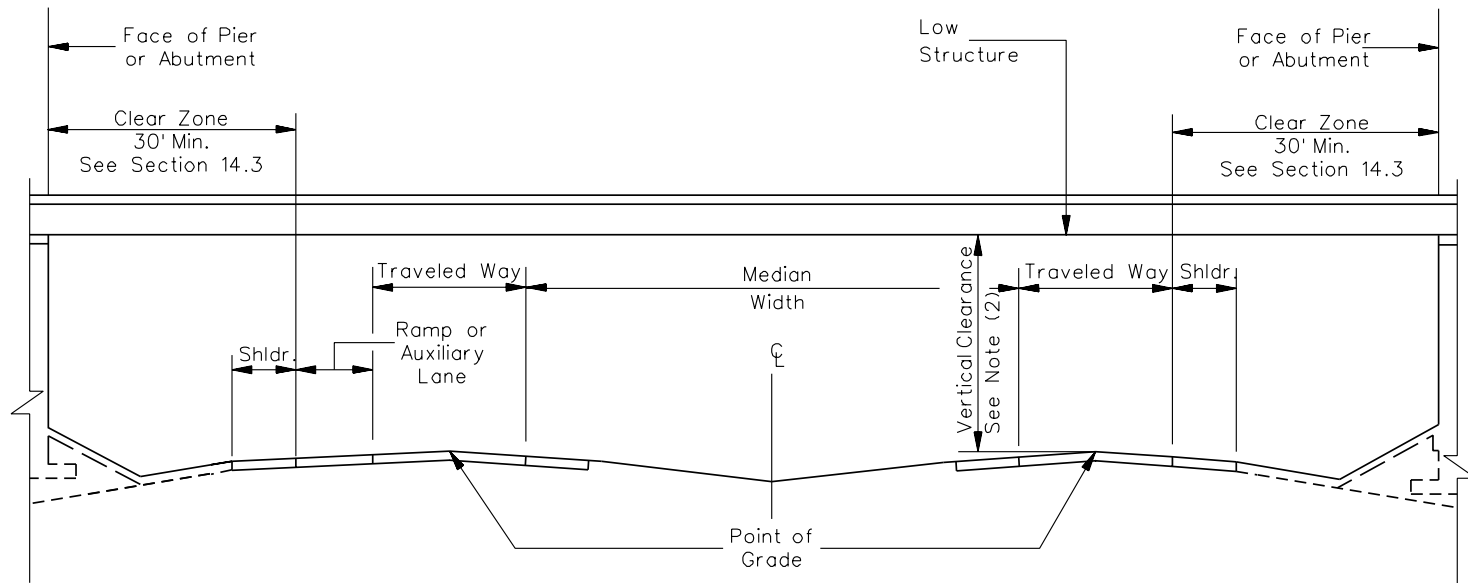

CLEARANCE CONFIGURATIONS

Notes:

1. *Locate median piers, when required, on the median centerline when the median width provides less than the required clear zone width.*
2. *Locate the minimum clearance point at the least clearance point above the usable roadway under, including stabilized shoulders.*

CLEARANCES FOR BRIDGES OVER FREEWAYS**Figures 19.4B**

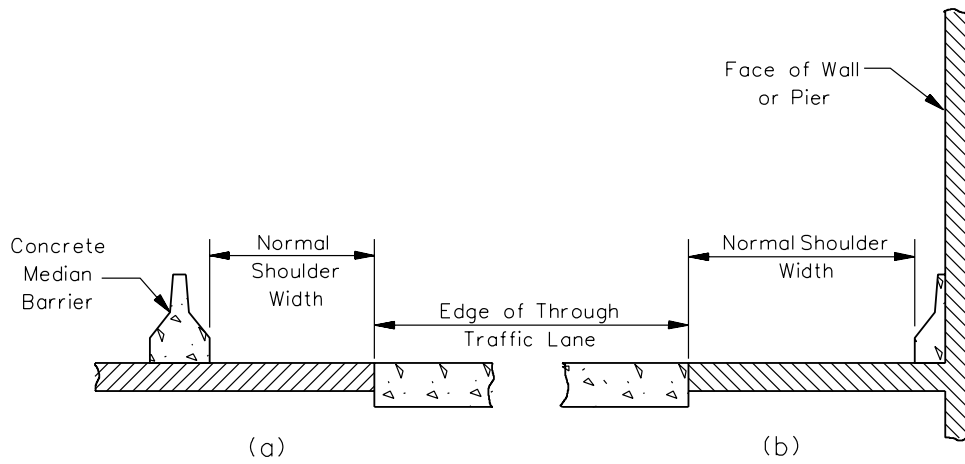

CONTINUOUS WALL OR BARRIER

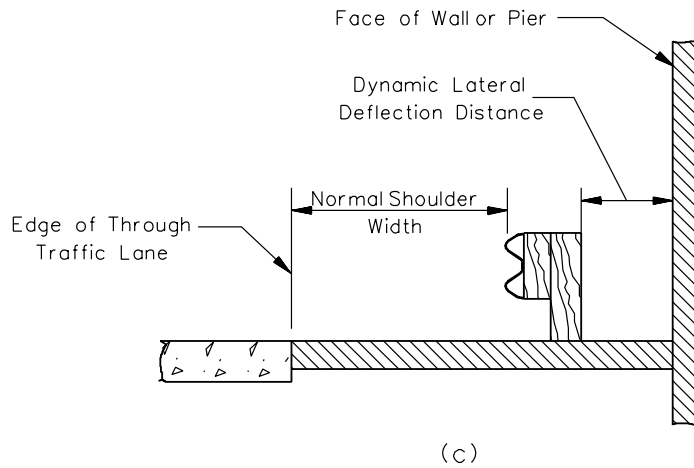

WITH GUARDRAIL RIGHT OR LEFT

LATERAL CLEARANCES FOR MAJOR ROADWAY UNDERPASSES

Figure 19.4C

19.5 MISCELLANEOUS ELEMENTS

19.5.1 Freeway Lane Drops

Lane reductions occur when there is a sufficient change in traffic volume in which the basic number of lanes can no longer be justified. Lane drops may occur as the result of:

- the introduction of auxiliary lanes at interchanges,
- in areas where there are multiple interchanges, and/or
- collector-distributor roads necessitating multiple lanes that no longer are required to handle existing or projected traffic volumes.

Freeway lane drops should normally occur on the freeway mainline away from any other turbulence (e.g., interchange exits and entrances). [Figure 19.5A](#) illustrates the recommended design of a lane drop beyond an interchange. In addition, consider the following criteria when designing a freeway lane drop:

1. Location. The lane drop should occur approximately 2,500 feet beyond the previous interchange ramp. The 2,500 feet allows for adequate signing and driver adjustments from the interchange, but yet is not so far downstream that drivers become accustomed to the number of lanes and are surprised by the lane drop. In addition, do not drop a lane on a horizontal curve or where other signing is required (e.g., an upcoming exit).
2. Transition. Lane drops that involve pavement width changes should be transitioned over a length equal to the product of the change in lane width (W) times the design speed (S). [Figure 19.5B](#) provides lane drop transition lengths for 12-foot lanes. Maximum transition taper rate will be 70:1.
3. Sight Distance. Decision sight distance should be available to any point within the entire lane transition. See [Section 10.3](#) for applicable decision sight distance values. These criteria would favor, for example, placing a freeway lane drop within a sag vertical curve or at a location where the freeway lies on an upgrade but not just beyond a crest.
4. Right-side Versus Left-side Drop. Right-side freeway lane drops are preferred due to the merging of slower vehicles and normal driver expectations. For the situation where the left lane is to be continued in the median in the future, the right-side lane drop is still preferred. If a left-side lane drop is used, provide advance supplemental signing, longer taper lengths and 12-foot wide paved left-shoulders beyond the area of the proposed lane drop.
5. Shoulders. Maintain the full-width right shoulder through a right-side lane drop.

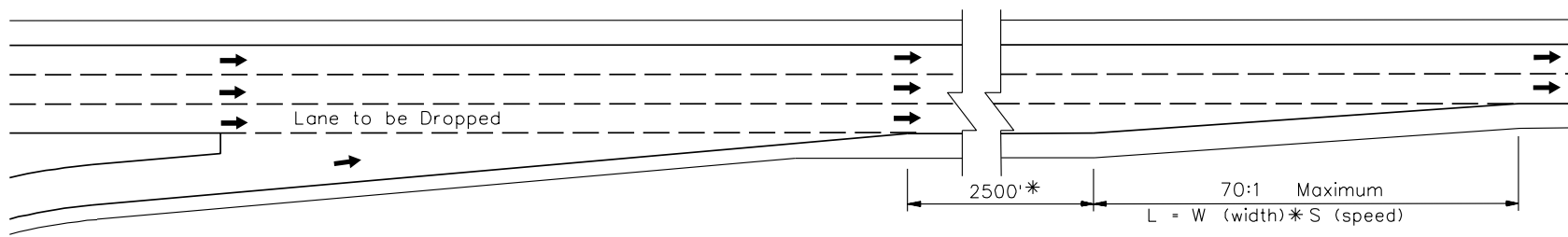

* Distance between entrance ramp taper and lane drop taper should be at least 2500 feet.

TYPICAL FREEWAY LANE DROP (RIGHT SIDE)

Figure 19.5A

Design Speed (mph)	Transition Length (feet)
55	660
60	720
65	780
70	840
75	840

TRANSITION LENGTH FOR 12-FOOT FREEWAY LANE DROP

Figure 19.5B

19.5.2 Weaving

Weaving sections should be designed so that the LOS within the area of weaving is consistent with the remainder of the highway. The design LOS of weaving sections depends upon their length, number of lanes, acceptable degree of congestion and relative volumes of individual traffic movements. Weaving sections may be considered as single or multiple. Detailed discussions of freeway weaving sections, relating to the operation and analysis, are contained in the *Highway Capacity Manual*.

19.5.3 Frontage Roads

19.5.3.1 General

Frontage roads are parallel roads adjacent and outside the controlled access lines of freeways and other controlled access highways. It is preferable that frontage roads be located generally parallel to freeways on an independent right of way. For example, if the typical freeway right of way is 150 feet from the centerline of the median, then an additional 66 to 90 feet of right of way should be provided for the frontage road. Alternatively, frontage roads can be located a distance of 300 to 400 feet from the freeway right of way, allowing for industrial and/or commercial development to occur on both sides of frontage roads.

At rural interchanges, frontage roads should intersect with crossroads at a distance of approximately 500 feet (desirable) from ramp terminals. In urban areas, these distances may be reduced to 300 feet (desirable). Providing adequate distance between ramp/crossroad and frontage road/crossroad intersections avoids operational and safety problems. Where right of way restrictions are not a consideration, the distance between the ramp terminal and frontage road should be as liberal as practical.

Where freeways sever existing low-volume roads, the designer must determine if the road is to be closed, provided with a cul-de-sac, rerouted, provided with a grade separation or provided with a frontage road. This decision should be based on economics and, if necessary, through a benefit/cost study. Desirably, a freeway should be located so that a minimum number of properties are severed by its location. Realizing that this is not always practical or feasible, frontage roads are provided for access to severed properties. The designer, with the assistance of the Right of Way Office, should conduct an economic justification study to determine if it is more economical to construct the frontage road or pay severance damages for loss of access.

19.5.3.2 Outer Separations

The area between the traveled way and a frontage road or street is referred to as the outer separation. If there are no adjoining frontage roads or local streets, then these areas are referred to as borders. Basically, outer separations or borders provide areas for shoulders, slopes, drainage facilities, controlled access fencing, walls, ramps and noise abatement barriers. Outer separations may also serve as recovery areas for errant vehicles. In urban areas, the outer separation may require a reduced width due to certain restrictions (e.g., retaining walls, right of way restrictions). Typical outer separations between freeways and frontage roads are shown in [Figure 19.5C](#).

19.5.3.3 Functional Classification

The normal design elements of pavement width, cross slope, horizontal and vertical alignment, etc., should be provided consistent with the functional operation of the frontage road. That is, the same considerations relative to functional classification, design speed, traffic volumes, etc., apply to frontage roads as they apply to any other highway. The functional classification of the frontage road will be determined on a case-by-case basis.

19.5.3.4 Design

In the design of frontage roads, consider the following:

1. Design Criteria. The selection of the appropriate design criteria is based on the functional classification of the frontage road. Once the frontage road classification has been determined, the appropriate design elements (e.g., design speed, lane and shoulder widths) can be selected. For freeways, the frontage road design criteria can be found in [Chapters 20](#) and [21](#).

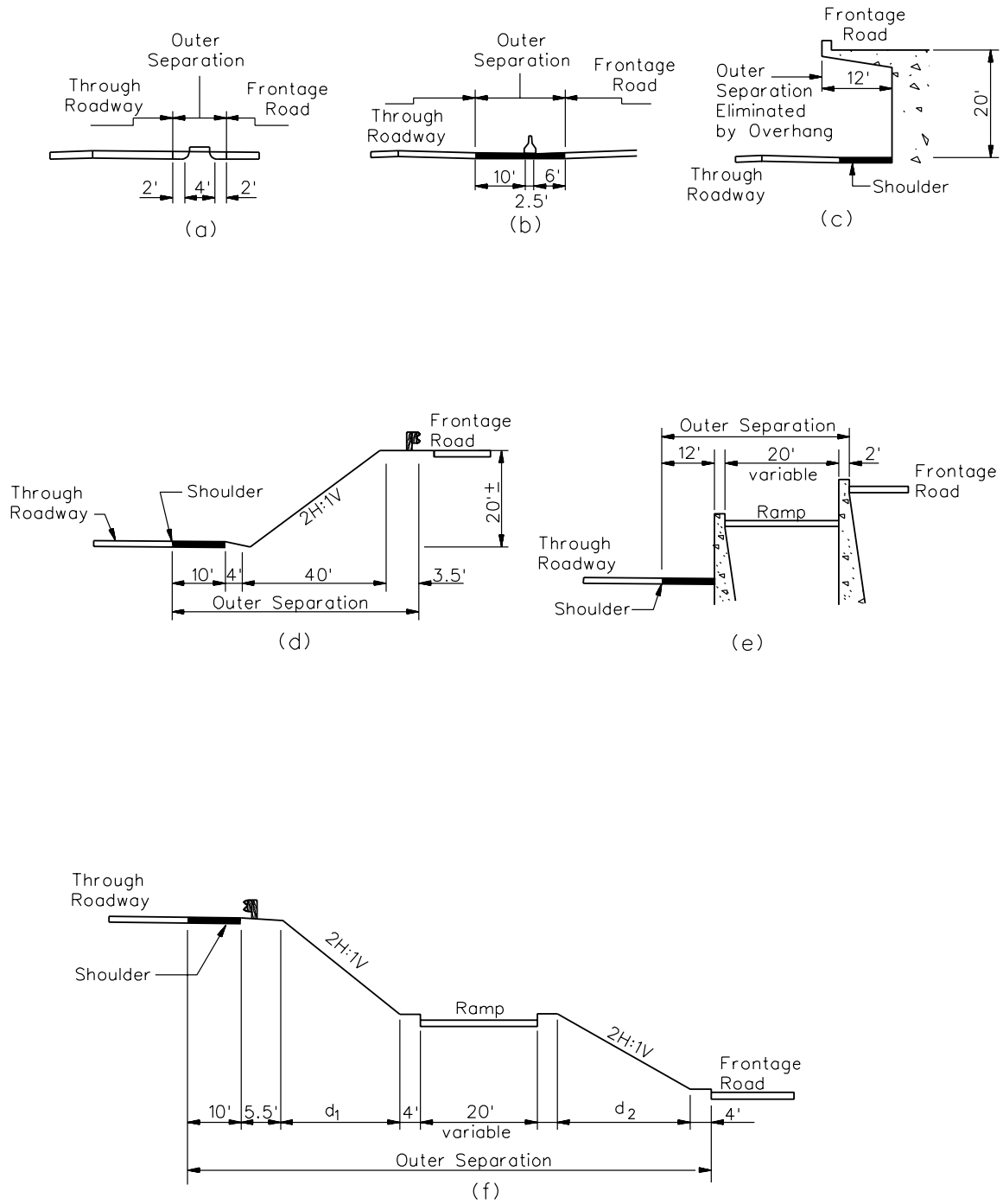

TYPICAL OUTER SEPARATIONS
Figure 19.5C

2. One-Way/Two-Way. Two-way frontage roads are used in suburban or rural areas where the adjoining street system is so irregular or so disconnected that one-way operation would introduce considerable added travel distance and cause undue inconvenience. Two-way frontage roads are also used in many urban situations. From an operational and safety perspective, one-way urban frontage roads are preferred to two-way. One-way operations may inconvenience local traffic to some extent, but the advantages in reducing vehicular and pedestrian conflicts at intersecting streets often fully compensates for this inconvenience. Two-way frontage roads at high-volume, urban intersections may complicate crossing and turning movements. Off ramps (e.g., slip ramps) joining two-way frontage roads should not be used because of the potential for wrong-way entry.
3. Outer Separation. See [Section 19.5.3.2](#) for discussion on outer separation.
4. Access to Freeways. Connections between the main highway and the frontage road are an important design element. On facilities with lower operational speeds and one-way frontage roads, slip ramps or simple openings in a narrow outer separation may work reasonably well. Slip ramps from one-way frontage roads and freeways are acceptable. Because slip ramps from a freeway to two-way frontage roads tend to induce wrong-way entry onto the freeway and may cause crashes at the intersection of the ramp and frontage road, the access to the freeway must be provided with interchanges.

19.5.4 Pedestrians

Where planned freeway construction will divide established communities, resulting in the termination of streets and sidewalks, designers should investigate the spacing of the remaining crossing streets and sidewalks. This should be done in conjunction with the volume of diverted pedestrian traffic and associated distances that pedestrian traffic is required to travel to determine the need for intermediate pedestrian grade separation crossings. FHWA's, *A Pedestrian Planning Procedures Manual*, outlines a method of converting walking distance, time and safety into dollars for use when comparing relative cost versus benefits with and without pedestrian structures.

19.5.5 Noise Barriers

As part of the continuing assessment of human reaction to construction and maintenance of highways and in accordance with established environmental assessment procedures, noise barriers may be provided. If a decision is made that noise barriers are required, insure their construction will not compromise the highway safety. Major design considerations should include the following:

- Insure that adequate lateral clearances are obtained in accordance with clear zone requirements in [Section 14.3](#). Noise barriers should be located at or near the right of way line.
- Insure that adequate stopping sight distance is not impaired.
- Design noise barriers, to the greatest extent feasible, so that they will not appear obtrusive to drivers. Alternatives (e.g., landscaped earthen berms) should be considered.

19.6 REFERENCES

1. *A Policy on Geometric Design of Highways and Streets*, AASHTO, 2001.
2. *A Policy on Design Standards — Interstate System*, AASHTO, draft, 2002.
3. *Highway Safety Design and Operations Guide*, AASHTO, 1997.

Table of Contents

<u>Section</u>	<u>Page</u>
20.1 TWO-LANE HIGHWAYS.....	20.1(1)
20.1.1 Scoping	20.1(1)
20.1.2 Design Elements	20.1(2)
20.1.2.1 Level of Service	20.1(2)
20.1.2.2 Design Speed	20.1(2)
20.1.2.3 Sight Distances	20.1(2)
20.1.2.4 Typical Sections.....	20.1(3)
20.1.3 Alternatives to Widening.....	20.1(3)
20.1.3.1 Passing Sight Distance	20.1(3)
20.1.3.2 Three-Lane Highways –Two-Way, Left-Turn Lanes.....	20.1(3)
20.1.3.3 Intersection Treatments	20.1(6)
20.1.3.4 Climbing Lanes	20.1(6)
20.1.3.5 Passing Lanes	20.1(6)
20.1.4 Tables of Design Criteria	20.1(9)
20.2 MULTILANE HIGHWAYS.....	20.2(1)
20.2.1 Design Elements	20.2(1)
20.2.1.1 Traffic Volumes	20.2(1)
20.2.1.2 Design Speed	20.2(1)
20.2.1.3 Sight Distances	20.2(2)
20.2.1.4 Typical Sections.....	20.2(2)
20.2.1.5 Medians	20.2(2)
20.2.2 Transition Figures.....	20.2(2)
20.2.3 Frontage Roads.....	20.2(2)
20.2.4 Tables of Design Criteria	20.2(5)
20.3 REFERENCES.....	20.3(1)

Chapter Twenty

RURAL HIGHWAYS

Chapter 20 provides guidance in the design of rural two-lane principal arterials, rural multilane principal arterials, rural two-lane minor arterials and collectors on the State Highway System. [Chapter 22](#) discusses the design of rural local roads. Information that is also applicable to these facilities is included in the following Chapters:

- [Chapters 9, 10, 11, 12 and 13](#) provide guidance on geometric design elements that are also applicable to these facilities.
- [Chapter 14](#) provides guidelines on roadside safety issues.
- [Chapter 15](#) provides information on the design of intersections including left- and right-turn lanes, channelization and intersection sight distance.

20.1 TWO-LANE HIGHWAYS

Two-lane highways are the predominant type of roadway of the South Carolina Highway System. They serve the widest range of functional classes – arterial, collector and local – providing mobility and accessibility in varying degrees. Their wide range of functions and traffic service requirements present highway engineers with the need to carefully select the proper design criteria. This Section discusses the design criteria applicable to two-lane rural highways. In some cases, new facilities are developed as two-lane highways as part of staged construction projects with the knowledge that the highway facility will ultimately become a multilane facility. Limited funding resources or other factors may restrict it from being multilaned initially. In these instances, use the design criteria presented in [Section 20.2](#).

20.1.1 Scoping

When designing for a rural two-lane highway, consider the following:

1. Most of the roads developed as part of the State's "C" System do not qualify under the design criteria established in this Chapter. See [Section 22.1.2](#) for more information on "C" highway projects.
2. The construction of new roads or upgrading of existing county roads that may eventually become part of the State's rural collector road system should be designed and constructed to meet desirable design criteria discussed in this Section.

20.1.2 Design Elements

20.1.2.1 Level of Service

Two-lane arterial and collector roads should be designed to accommodate the highest practical criteria consistent with anticipated traffic and topography. The basic designs of these highways are influenced by safety, traffic volume, terrain and alignment. The level of service (LOS) criteria for rural highways are presented in the geometric design tables presented in [Section 20.1.4](#).

For the LOS analysis, the *Highway Capacity Manual* categorizes two-lane highways into the following classes:

1. Class I Highways. These are two-lane highways on which motorists expect to travel at relatively high speeds. These highways are major intercity routes, primary arterials connecting major traffic generators, daily commuter routes and/or primary links in the State and National Highway Systems. Most arterials are considered Class I highways.
2. Class II Highways. These are two-lane highways on which motorists do not necessarily expect to travel at high speeds. These highways function as access routes to Class I facilities, serve as scenic or recreational routes that are not arterials and/or pass through rugged terrain. Most collectors and local roads are considered Class II highways.

The LOS analysis for Class I is based on both the percent time-spent-following and average travel speed. For Class II highways, mobility is less important; therefore, the LOS determination is only based on the percent time-spent-following.

20.1.2.2 Design Speed

Design speeds for rural arterials are based on terrain, driver expectancy and the alignment. See [Section 9.5.2](#) for more information on the selection of design speeds.

20.1.2.3 Sight Distances

At a minimum, the two-lane highway will be designed to meet the stopping sight distance. However, because two-lane roads require motorists to cross the centerline to perform passing maneuvers, passing and decision sight distances are important factors in their design. Providing decision sight distance at locations where complex decisions are made (e.g., high-volume intersections, transitions in roadway width, transitions in the number of lanes) greatly enhances the driver's ability to safely accomplish these maneuvers. Intersection sight distance should be provided at all intersections.

See [Chapter 10](#) for a more detailed discussion on the various sight distances.

20.1.2.4 Typical Sections

[Figures 20.1A](#) and [20.1B](#) illustrate typical schematic cross sections for two-lane highways. The tables in [Section 20.1.4](#) provide the minimum criteria for lane widths, shoulder widths and other cross section elements that should be used on rural two-lane highways.

20.1.3 Alternatives to Widening

Rural two-lane highways that are not candidates for widening to four-lane facilities but are experiencing operational and safety problems or site-specific reductions in LOS may be considered for one or more of the following improvements:

- realigning to improve passing sight distance;
- widening to provide three-lane roadway segments with two-way, left-turn lanes;
- providing a truck-climbing lane; and
- providing passing lanes.

20.1.3.1 Passing Sight Distance

Passing sight distance for two-lane rural highways is critical to the safe operation and capacity of highways. Where sections of existing two-lane highways are carrying substantial volumes of vehicles, increased crash rates or other safety problems, consideration should be given to realignment in order to improve horizontal and/or vertical geometry. This redesign inherently increases the passing sight distance. The minimum passing sight distances for two-lane highways are discussed in [Section 10.2](#).

20.1.3.2 Three-Lane Highways –Two-Way, Left-Turn Lanes

Two-way, left-turn lanes (TWLTL) are viable alternatives where the number of left-turning vehicles is significant. [Section 21.2.7](#) provides the guidelines and criteria for TWLTL. The use of the third or median lane for left-turning vehicles is not normally provided where posted speed limits exceed 50 miles per hour. Therefore, their applicability to rural highways is typically near suburban areas or for roads passing through small towns. This alternative eliminates the possibility for the passing maneuver.

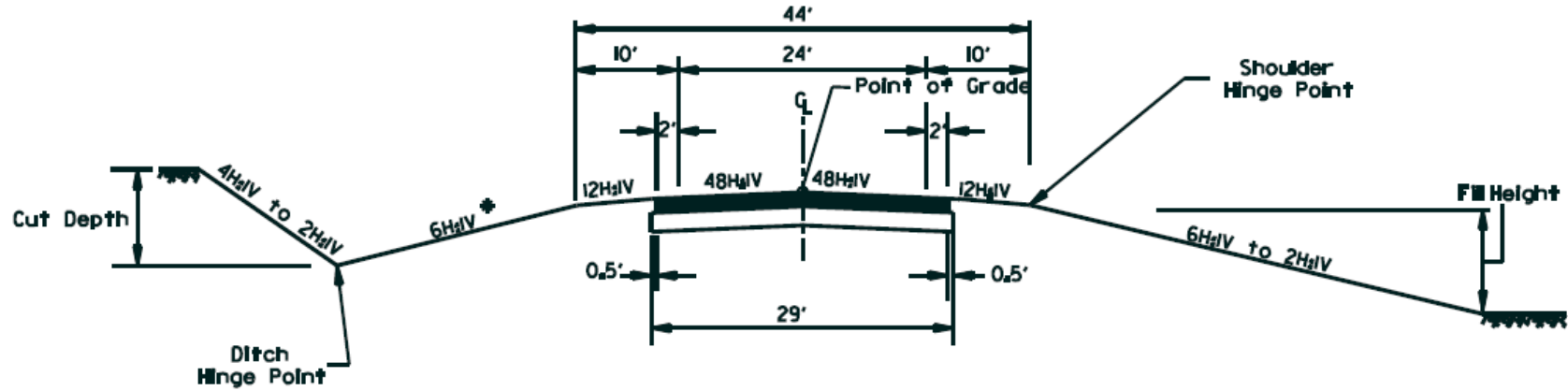

* THIS SLOPE MAY BE VARIED WHEN A DEEPER DITCH IS NECESSARY FOR DRAINAGE PURPOSES, USING A MINIMUM SLOPE OF 12:1 AND A MAXIMUM SLOPE OF 4:1. WHERE A DEEPER DITCH THAN PROVIDED BY A 4:1 IS NECESSARY, THE DITCH SHALL BE PLACED FARTHER FROM THE G_L CONTINUING THE 4:1 SLOPE TO PROVIDE FOR THE NECESSARY DEPTH. SEE PROFILE FOR THE SPECIAL DITCH GRADES.

TYPICAL RURAL TWO-LANE ARTERIALS

Figure 20.1A

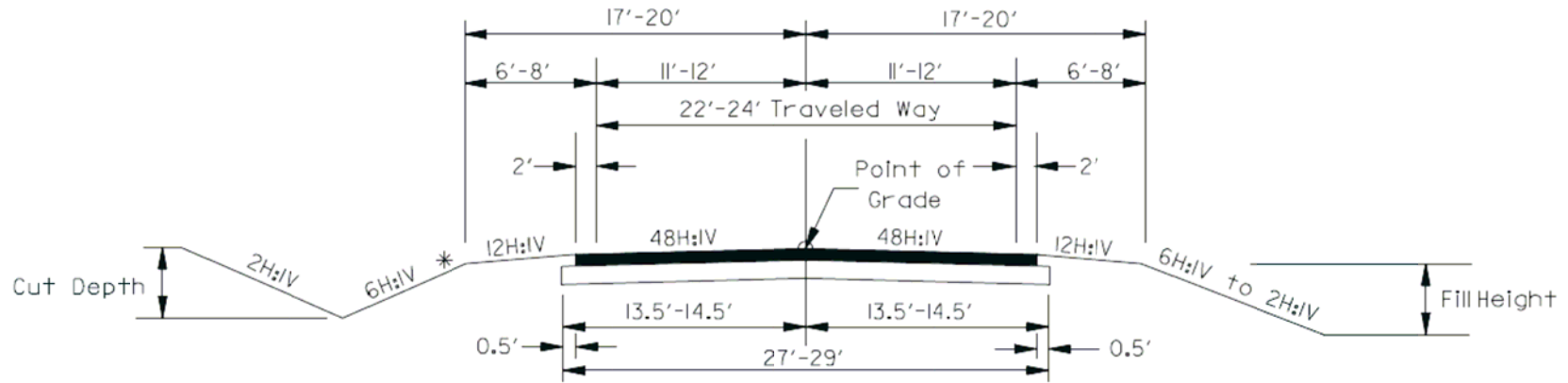

* THIS SLOPE MAY BE VARIED WHEN A DEEPER DITCH IS NECESSARY FOR DRAINAGE PURPOSES, USING A MINIMUM SLOPE OF 12:1 AND A MAXIMUM SLOPE OF 4:1. WHERE A DEEPER DITCH THAN PROVIDED BY A 4:1 IS NECESSARY, THE DITCH SHALL BE PLACED FARTHER FROM THE \bar{C}_L CONTINUING THE 4:1 SLOPE TO PROVIDE FOR THE NECESSARY DEPTH. SEE PROFILE FOR THE SPECIAL DITCH GRADES.

TYPICAL RURAL TWO-LANE COLLECTORS

Figure 20.1B

20.1.3.3 Intersection Treatments

Depending on the access demands for a particular two-lane facility, intersections can be a critical part of a facility's design. The use of left-turn lanes and bypass lanes to facilitate the movement and enhance the safety of through traffic at intersections is a cost-effective approach for upgrading two-lane rural highways. Detailed analyses of intersections should be performed in accordance with procedures in the *Highway Capacity Manual*.

When modifying intersections, the designer should consider the following:

- design vehicle,
- signal warrants,
- sight distance,
- crash analyses,
- turning movements/lane warrants,
- intersection alignment,
- right of way requirements,
- LOS analysis, and
- economic factors

For additional guidance, see [Section 15.2.1](#).

20.1.3.4 Climbing Lanes

In areas with steep grades, reduced truck speeds may significantly effect the facility's capacity and safety. However, truck climbing lanes can effectively increase capacity and safety. The warrant and design criteria for truck-climbing lanes are discussed in [Section 12.4](#).

20.1.3.5 Passing Lanes

Passing lanes, other than truck-climbing lanes, may be warranted on two-lane facilities where passing opportunities are not adequate or when an engineering study, operational experience and a capacity analysis concludes that there is a critical need. [Figure 20.1C](#) illustrates several passing lane designs. The use of a passing lane is determined on a case-by-case basis.

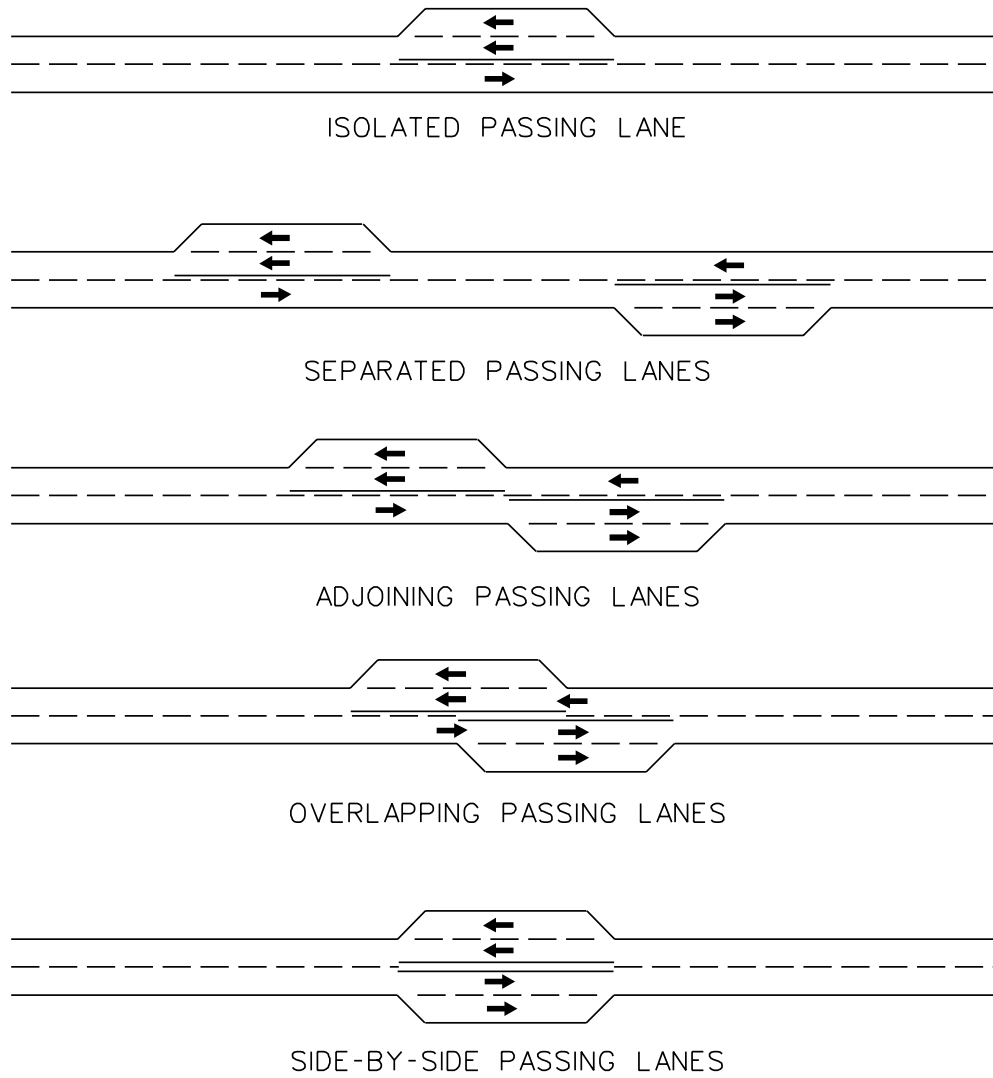

TYPICAL CONFIGURATIONS FOR PASSING LANES

Figure 20.1C

Short segments of a four-lane section, designated as side-by-side passing lanes in [Figure 20.1C](#), may be constructed along a two-lane highway to break up platoons, to provide the desired frequency of safe passing zones and to eliminate interference from low-speed vehicles. These sections may be advantageous in rolling terrain, where the horizontal and vertical alignment prohibits passing. The decision to use a short four-lane segment, as compared to using a three-lane option, should be based on long-range planning objectives for the facility, the availability of right of way, the existing cross section, topography and the need to reduce platooning and passing problems.

When designing passing lanes, consider the following:

1. Sight Distance. Provide sufficient sight distance (e.g., 1000 feet) in the transition area from the two-lane section to the passing section to allow a driver to anticipate the passing opportunity.
2. Length. Passing sections of 0.5 to 1.0 mile in length are usually sufficient to dissipate most platoons formed by slow vehicles and terrain conditions. Segments much longer than this are discouraged; as drivers tend to forget that they are driving on a two-lane highway. Passing lanes should be at least 1000 feet in length.
3. Spacing. Initially, provide passing lanes at 10 to 15 mile intervals. As traffic volumes increase, additional passing locations can be provided at 3 to 5 mile intervals.
4. Cross Sections. The lane and shoulder width should match the adjacent section of the two-lane highway.
5. Major Intersections. Special treatments may be required at major intersections (e.g., separate turning lanes, signalization) that may effect the location of passing lanes. Low-volume intersections and most driveways do not usually cause concerns.
6. Signing and Pavement Markings. Signing and pavement markings for a passing lane should meet the criteria in the *MUTCD*.

For more information on passing lane warrants and design criteria, see the FHWA publication *Low Cost Methods for Improving Traffic Operations on Two-Lane Roads*, Report No. FHWA-IP-87-2.

20.1.4 Tables of Design Criteria

Figures 20.1D through 20.1G present the Department's design and alignment criteria for rural two-lane arterials and two-lane collectors. The designer should consider the following when using these figures:

1. Functional Classification. To determine the latest functional classification of a facility, the designer should contact the Road Data Services.
2. Applicability. Note that some of the cross-section elements included in the figures (e.g., TWLTL) are not automatically warranted in the project design. The values in the figures only apply after the decision has been made to include the element in the highway cross section.
3. Manual Section References. These figures are intended to provide a concise listing of design values for easy use. However, the designer should review the *Manual* section references for more information on the design elements.
4. Footnotes. The figures include many footnotes, which are identified by a number in parentheses (e.g., (3)). The information in the footnotes is critical to the proper use of the design tables.
5. Controlling Design Criteria. The figures provide an asterisk to indicate controlling design criteria. If the values in the tables cannot be met, the designer should contact the Program Manager for alternatives. [Section 9.2](#) discusses this in more detail and presents the process for approving design exceptions to controlling criteria.

Design Element			Manual Section	Design Criteria	
Design Controls	Design Forecast Year		9.6.2	20 Years	
	*Design Speed (maximum)	Level	9.5.2	70 mph	
		Rolling		60 mph	
		Mountainous		50 mph	
	Access Control		9.8	Controlled by Regulation	
Level of Service		9.6.4	Level/Rolling: B Mountainous: C		
Cross Section Elements	*Travel Lane Width (1)		13.2.3	12'	
	*Shoulder Width (2)	Total Width	13.2.4	10'	
		Paved		2'	
	Auxiliary Lanes	Lane Width	13.2.5	12'	
		Shoulder Width		Total Width	10'
				Paved	2'
	Cross Slope	*Travel Lane		13.2.3.3	2.08%
		Auxiliary Lane		13.2.5	2.08%
		*Shoulder	Paved	13.2.4.3	2.08% (3)
			Unpaved		8.33%
TWLTL Width		21.2.7	15'		
Roadway Slopes	Side Slopes	Cut Section	Foreslope	13.3.1	6H:1V to 4H:1V
			Ditch Type		V-Ditch
			Back Slope		4H:1V to 2H:1V
			Rock Cut		0.25H:1V
	Fill Section	0' – 5'	13.3.1	6H:1V	
		5' – 10'		4H:1V	
		> 10'		2H:1V	
	Clear Zone		14.3	(4)	
Bridges	New and Reconstructed Bridges	*Structural Capacity	13.5.1.1	HL-93	
		*Clear Roadway Width		44' (5)	
	Existing Bridges to Remain in Place	*Structural Capacity	13.5.1.1	HS-20 (6)	
		*Clear Roadway Width		44'	
	*Vertical Clearance (Arterial Under) (7a)	New/Replaced Overpassing Bridges (7b)		12.6	17'-0"
		Existing Overpassing Bridges			16'-0"
		Pedestrian Bridges			18'-0"
		Overhead Signs			17'-6"
Clearance (Arterial Over)	*Railroads		12.6	23'-0"	
	Underpass Width		13.5.2	Traveled Way plus Clear Zone	

*Controlling design criteria (see Section 9.2).

**GEOMETRIC DESIGN CRITERIA FOR RURAL TWO-LANE ARTERIALS
(New Construction/Reconstruction)**

Figure 20.1D

**GEOMETRIC DESIGN CRITERIA FOR RURAL TWO-LANE PRINCIPAL ARTERIALS
(New Construction/Reconstruction)**

Footnotes for Figure 20.1D

- (1) Travel Lane Width. On reconstructed arterials, an existing 22-foot traveled way may be retained based on an engineering study.
- (2) Shoulder (Total Width). Where guardrail is required, increase the shoulder width an additional 3.5 feet.
- (3) Shoulder Cross Slopes. For paved shoulders greater than 2 feet, the shoulder cross slope should be 4.17 percent
- (4) Clear Zone. The clear zone will vary according to design speed, traffic volumes, side slopes and horizontal curvature.
- (5) New and Reconstructed Bridges (Clear Roadway Width). Clear roadway bridge widths are measured from face to face of parapets or rails. Bridge widths are normally defined as the sum of the approach traveled way width plus total shoulder width right and left.
- (6) Existing Bridges to Remain in Place. HS-20 capacity structure may be retained if it is not deficient.
- (7) Vertical Clearance (Arterial Under).
 - a. The clearance must be available over the traveled way, shoulders and any anticipated future widening.
 - b. Table value includes allowance for future overlays.

Design Element			Manual Section	Design Criteria		
Design Controls	Design Forecast Year		9.6.2	20 Years		
	Design Year Traffic (ADT)		9.6.3	0 to 400	400 to 2000	Over 2000
	*Design Speed (maximum)	Level	9.5.2	60 mph		
		Rolling		50 mph		
		Mountainous		40 mph		
Access Control		9.8	Controlled by Regulation			
Level of Service		9.6.4	C			
Cross Section Elements	*Travel Lane Width		13.2.3	11' (1a)	11'	12' (1b)
	*Shoulder Width (2a)		13.2.4	6' (2b)	6' (2b)	8'
	Auxiliary Lanes	Lane Width	13.2.5	11'	11'	12'
		Shoulder Width		6'	6'	8'
	Cross Slope	*Travel Lane	13.2.3.3	2.08%		
		Auxiliary Lane	13.2.5	2.08%		
		*Shoulder	13.2.4.3	8.33%		
TWLTL Width		21.2.7	15'			
Roadway Slopes	Side Slopes	Cut Section	Foreslope	6H:1V to 4H:1V		
			Ditch Type	V-Ditch		
			Back Slope	4H:1V to 2H:1V		
			Rock Cut	0.25H:1V		
		Fill Section	0' – 5'	13.3.1	6H:1V	
	5' – 10'		4H:1V			
	> 10'		2H:1V			
Clear Zone		14.3	(3)			
Bridges	New and Reconstructed Bridges	*Structural Capacity		HL-93		
		*Clear Roadway Width (4)	13.5.1.1	34'	34'	40'
	Existing Bridges to Remain in Place	*Structural Capacity		H-15		
		*Clear Roadway Width	13.5.1.1	22'	24'	28'
	*Vertical Clearance (Collector Under) (5a)	New/Replaced Overpassing Bridges (5b)	12.6	16'-0"		
		Existing Overpassing Bridges		16'-0"		
		Pedestrian Bridges		18'-0"		
		Overhead Signs		17'-6"		
Clearance (Collector Over)	*Railroads	12.6	23'-0"			
	Underpass Width	13.5.2	Traveled Way plus Clear Zone			

* Controlling design criteria (see Section 9.2).

**GEOMETRIC DESIGN CRITERIA FOR RURAL TWO-LANE COLLECTORS
(New Construction/Reconstruction)**

Figure 20.1E

**GEOMETRIC DESIGN CRITERIA FOR RURAL TWO-LANE COLLECTORS
(New Construction/Reconstruction)**

Footnotes for [Figure 20.1E](#)

- (1) Travel Lane Width.
 - a. Where the design speed is 40 miles per hour or less and the ADT is less than 250 vehicles per day, 10-foot travel lanes may be considered.
 - b. On reconstructed collectors, an existing 22-foot traveled way may be retained based on an engineering study.
- (2) Shoulder Width (Total Width).
 - a. Where guardrail is required, increase the shoulder width an additional 3.5 feet.
 - b. For ADT's less than 1500 vehicles per day, the shoulder width may be reduced to a minimum roadway width of 30 feet.
- (3) Clear Zone. The clear zone will vary according to design speed, traffic volumes, side slopes and horizontal curvature.
- (4) New and Reconstructed Bridges (Clear Roadway Width). Clear roadway bridge widths are measured from face to face of parapets or rails. Bridge widths are normally defined as the sum of the approach traveled way width plus total shoulder width right and left.
- (5) Vertical Clearance (Collector Under).
 - a. The clearance must be available over the traveled way, shoulders, and any anticipated future widening.
 - b. Table value includes allowance for future overlays.

Design Element	Manual Section	Design Speed							
		40 mph	45 mph	50 mph	55 mph	60 mph	65 mph	70 mph	
*Stopping Sight Distance (1)	10.1	305'	360'	425'	495'	570'	645'	730'	
Passing Sight Distance	10.2	1470'	1625'	1835'	1985'	2135'	2285'	2480'	
Intersection Sight Distance (2)	10.4	445'	500'	555'	610'	665'	720'	775'	
*Minimum Radii	11.2.3	$e_{max} = 8\%$	–	–	–	965'	1205'	1485'	1820'
		$e_{max} = 6\%$	510'	660'	835'	–	–	–	–
*Superelevation Rate (3)	11.3	6%	6%	6%	8%	8%	8%	8%	
*Horizontal Sight Distance (4)	11.4	23'	24'	27'	32'	34'	35'	36'	
*Vertical Curvature (K-values) (5)	12.5	Crest	44	61	84	114	151	193	247
		Sag	64	79	96	115	136	157	181
*Maximum Grade	12.3.1	Level	5%	5%	4%	4%	3%	3%	3%
		Rolling	6%	6%	5%	5%	4%	4%	4%
		Mountainous	8%	7%	7%	6%	6%	5%	5%
Minimum Grade (6)	12.3.2	0.5%							

*Controlling design criteria (see [Section 9.2](#)).

- (1) Stopping Sight Distance. Table values are for passenger cars on level grade.
- (2) Intersection Sight Distance. Table values are for passenger cars for assumed conditions described in [Figure 10.4C](#).
- (3) Superelevation Rate. See [Section 11.3](#) for superelevation rates based on e_{max} , design speed and radii of horizontal curves.
- (4) Horizontal Sight Distance. Table values provide the necessary middle ordinate assuming the maximum radii and stopping sight distance.
- (5) Vertical Curvature (K-Value). K-values are based on the level stopping sight distances.
- (6) Minimum Grade. Longitudinal gradients of 0 percent may be acceptable on some pavements that have cross slopes that insure adequate drainage. Special ditch grades may be necessary to insure proper project runoff management.

ALIGNMENT CRITERIA FOR RURAL ARTERIALS

Figure 20.1F

Design Element		Manual Section	Design Speed						
			30 mph	35 mph	40 mph	45 mph	50 mph	55 mph	60 mph
*Stopping Sight Distance (1)		10.1	200'	250'	305'	360'	425'	495'	570'
Passing Sight Distance		10.2	1090'	1280'	1470'	1625'	1835'	1985'	2135'
Intersection Sight Distance (2)		10.4	335'	390'	445'	500'	555'	610'	665'
*Minimum Radii	e _{max} = 8%	11.2.3	–	–	–	–	–	965'	1205'
	e _{max} = 6%		275'	380'	510'	660'	835'	–	–
*Superelevation Rate (3)		11.3	6%	6%	6%	6%	6%	8%	8%
*Horizontal Sight Distance (4)		11.4	18'	20'	23'	24'	27'	32'	34'
*Vertical Curvature (K-values) (5)	Crest	12.5	19	29	44	61	84	114	151
	Sag		37	49	64	79	96	115	136
*Maximum Grade (6)	Level	12.3.1	7%	7%	7%	7%	6%	6%	5%
	Rolling		9%	9%	8%	8%	7%	7%	6%
	Mountainous		10%	10%	10%	10%	9%	9%	8%
Minimum Grade (7)		12.3.2	0.5%						

*Controlling design criteria (see Section 9.2).

- (1) Stopping Sight Distance. Table values are for passenger cars on level grade.
- (2) Intersection Sight Distance. Table values are for passenger cars for assumed conditions described in Figure 10.4C.
- (3) Superelevation Rate. See Section 11.3 for superelevation rates based on e_{max}, design speed and radii of horizontal curves.
- (4) Horizontal Sight Distance. Table values provide the necessary middle ordinate assuming the maximum radii and stopping sight distance.
- (5) Vertical Curvature (K-Value). K-values are based on the level stopping sight distances.
- (6) Maximum Grades. Short lengths of grades (e.g., less than 500 feet), one-way downgrades and low-volume collectors may be up to 2 percent steeper.
- (7) Minimum Grade. Longitudinal gradients of 0 percent may be acceptable on some pavements that have cross slopes that insure adequate drainage. Special ditch grades may be necessary to insure proper project runoff management.

ALIGNMENT CRITERIA FOR RURAL COLLECTORS

Figure 20.1G

20.2 MULTILANE HIGHWAYS

Multilane highways have two or more lanes in each direction and may be one-way, two-way, divided or undivided. Most rural multilane facilities are rural principal arterials. The design criteria for these facilities are presented in Section 20.2.

20.2.1 Design Elements

While many of the cross-sectional elements for rural multilane highways are similar to those of a freeway, traffic flow is not as efficient. The following design elements effect a multilane highway's efficiency:

- the frequency of signalized and unsignalized intersections,
- the spacing of signalized intersections,
- the frequency of driveways and other uncontrolled access points,
- the number of left turns, and
- the number of right turns.

20.2.1.1 Traffic Volumes

Estimates of future volumes of traffic are major considerations in the justification for new and reconstructed multilane rural highway facilities. Existing traffic volumes are the primary consideration for widening existing multilane highways in rural areas. When using traffic volumes to determine cross-sectional requirements, keep in mind that the composition of the traffic stream, location/number of intersections, control of access and number/spacing of signalized intersections have an influence on the ability of the highway facility to adequately handle traffic. The use of Average Daily Traffic (ADT) and Design Hourly Volume (DHV), discussed in [Section 9.6](#), are the most accepted practices for determining lane requirements for these highways.

Level of service criteria for rural multilane highways is defined in terms of density of traffic. [Figure 20.2C](#) presents the recommended levels of service for rural multilane arterials.

20.2.1.2 Design Speed

Typically, multilane highways are developed to handle moderate to high-speed traffic. [Section 20.2.4](#) presents the desirable and minimum designs for rural multilane facilities.

For more detailed information on design speed, see [Section 9.5.2](#).

20.2.1.3 Sight Distances

The stopping and intersection sight distances can be critical in certain aspects of design for rural multilane highways. See [Sections 10.1](#) and [10.4](#) for a detailed discussion on these sight distances.

20.2.1.4 Typical Sections

[Figure 20.2A](#) presents a typical section for a rural four-lane divided highway.

20.2.1.5 Medians

The medians used for rural multilane highways are the depressed and flush medians. The two-way, left-turn lane (TWLTL) may be appropriate at isolated rural locations, where the highway is transitioning into a suburban or urban area having sizable left-turn volumes, or where there are several closely spaced driveways. [Section 13.4](#) presents a detailed discussion on the functions and types of medians applicable to rural multilane highways. [Section 21.2.7](#) provides additional information on the warrants and design criteria for a TWLTL.

20.2.2 Transition Figures

[Figure 20.2B](#) provides typical design examples for transitioning from a two-lane facility to a four-lane facility with a depressed median. Because these areas present complex situations, consider providing decision sight distance throughout the transition area.

20.2.3 Frontage Roads

Where frontage roads are proposed in conjunction with multilane divided rural arterial highways, provide a contiguous but independent right of way adjacent to the mainline right of way. In certain instances, it may be advantageous to provide frontage roads that run parallel to the rural arterial, but have a wider separation resulting in two independent rights of way.

Where the profile grade of the arterial passes through major cuts and fills, the grade of the frontage road typically conforms to the existing ground line. The difference in elevation between the two adjacent facilities is provided for in the outer separations by earth slopes or possibly retaining walls.

For rural multilane principal arterials, the frontage road should be designed using the two-lane arterial criteria, see [Figures 20.1D](#) and [20.1F](#).

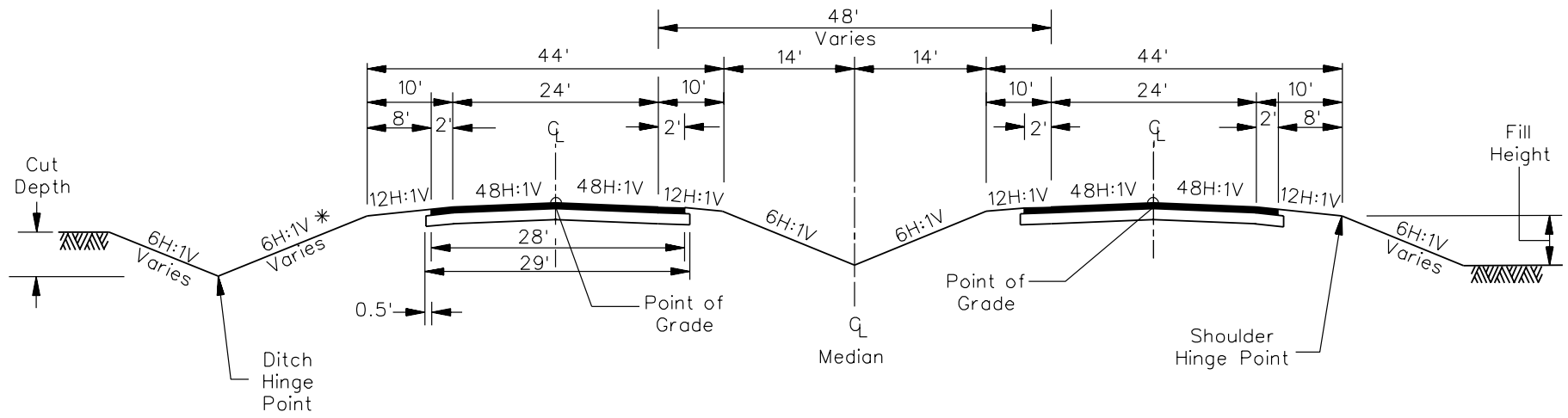

* This slope may vary where a deeper ditch is necessary. Place the ditch further away from the traveled way by continuing the 6H:1V slope to provide for the necessary depth.

TYPICAL RURAL FOUR-LANE DIVIDED ARTERIAL

Figure 20.2A

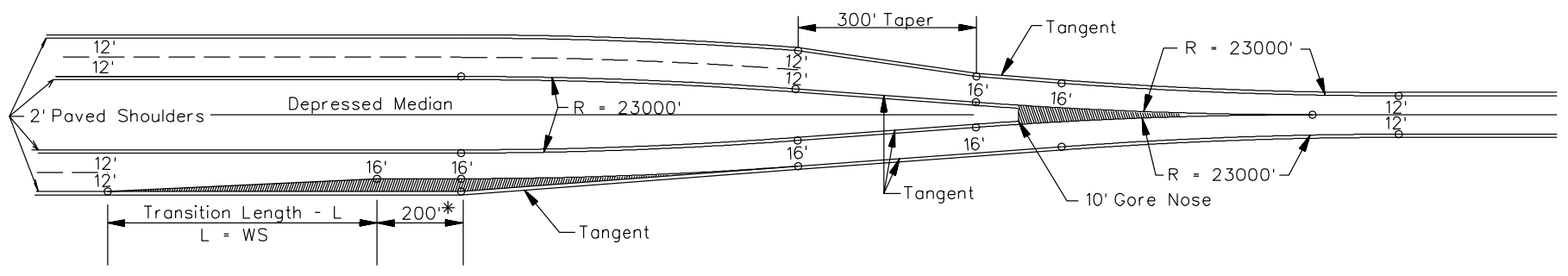

Example * Minimum or Superelevation Runout

$W = W_2 - W_1 = 24' - 16' = 8'$
 $S = \text{Design Speed} = 60 \text{ mph}$
 $L = 8' \times 60 \text{ mph} = 480'$

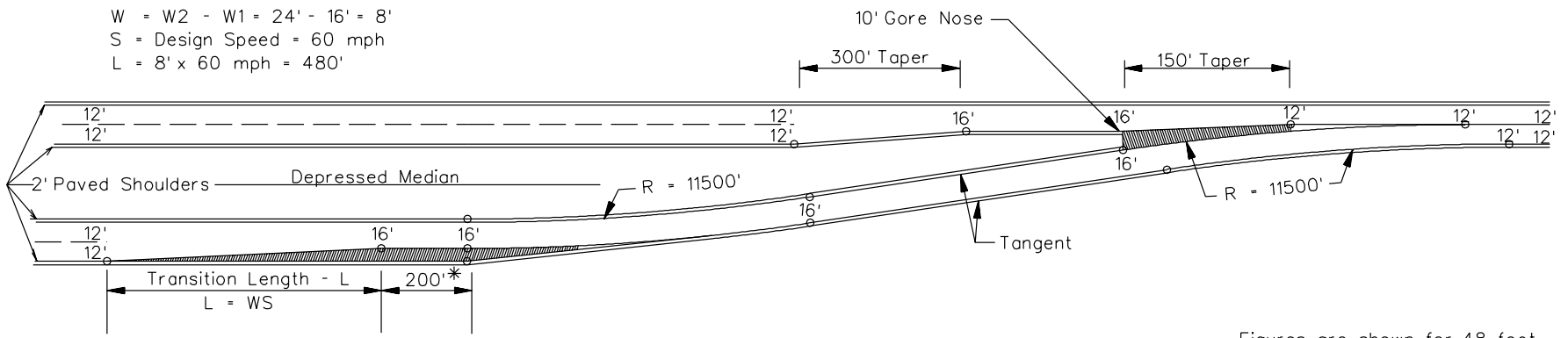

Example * Minimum Superelevation Runout

$W = W_2 - W_1 = 24' - 16' = 8'$
 $S = \text{Design Speed} = 60 \text{ mph}$
 $L = 8' \times 60 \text{ mph} = 480'$

Figures are shown for 48-foot wide median. Radii will change for different median widths.

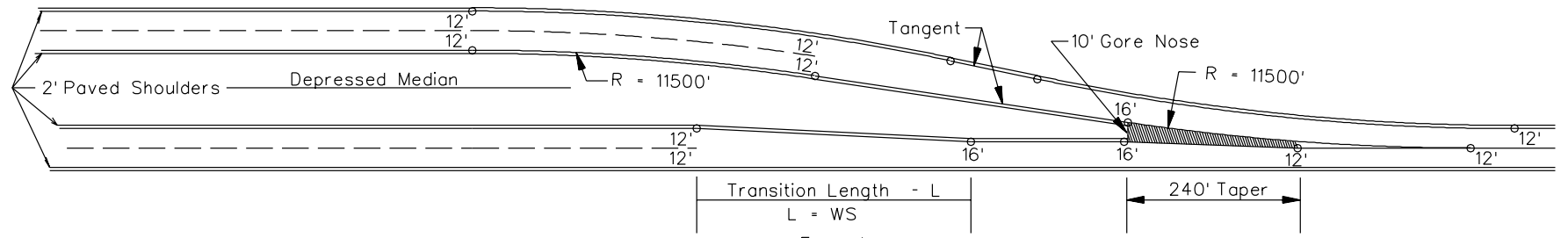

Example
 $W = W_2 - W_1 = 24' - 16' = 8'$
 $S = \text{Design Speed} = 60 \text{ mph}$
 $L = 8' \times 60 \text{ mph} = 480'$

LANE TRANSITION DESIGN ON TANGENT SECTION FROM FOUR TO TWO LANES

Figure 20.2B

20.2.4 Tables of Design Criteria

Figure 20.2C presents the Department's design criteria for rural four-lane principal arterials. Figure 20.2D presents the alignment criteria for arterials that are also applicable to multilane facilities. The designer should consider the following when using these figures:

1. Applicability. Note that some of the cross section elements included in the figures (e.g., TWLTL) are not automatically warranted in the project design. The values in the figures only apply after the decision has been made to include the element in the highway cross section.
2. Manual Section References. These figures are intended to provide a concise listing of design values for easy use. However, the designer should review the *Manual* section references for more information on the design elements.
3. Footnotes. The figures include many footnotes, which are identified by a number in parentheses (e.g., (3)). The information in the footnotes is critical to the proper use of the design tables.
4. Controlling Design Criteria. The figures provide an asterisk to indicate controlling design criteria. If the values in the tables cannot be met, the designer should contact the Program Manager for alternatives. Section 9.2 discusses this in more detail and presents the process for approving design exceptions to controlling criteria.

Design Element			Manual Section	Design Criteria	
Design Controls	Design Forecast Year		9.6.2	20 Years	
	*Design Speed (Maximum)	Level	9.5.2	70 mph	
		Rolling		60 mph	
		Mountainous		50 mph	
	Access Control		9.8	Controlled by Regulation	
Level of Service		9.6.4	Level/Rolling: B Mountainous: C		
Cross Section Elements	*Travel Lane Width (1)		13.2.3	12'	
	*Shoulder Width	Right	Total Width	13.2.4	10' (2)
			Paved		2'
		Left	Total Width		10' (2)
			Paved		2'
	Auxiliary Lanes	Lane Width		13.2.5	12'
		Shoulder Width	Total Width		10'
			Paved		2'
	Cross Slope	*Travel Lane		13.2.3.3	2.08%
		Auxiliary Lane		13.2.5	2.08%
		*Shoulder	Paved	13.2.4.3	2.08% (3)
			Unpaved		8.33%
Median Width	Depressed		13.4.2.3	48'	
	Flush (CMB)		13.4.2.1	24'	
Roadway Slopes	Side Slopes	Cut Section	Foreslope	13.3.1	6H:1V
			Ditch Type		V-Ditch
			Back Slope		6H:1V to 2H:1V
			Rock Cut		0.25H:1V
		Fill Section	0' – 5'		6H:1V
			5' – 10'		4H:1V
			> 10'		2H:1V
	Median Slopes (Depressed)		13.4.2.3	6H:1V to 8H:1V	
	Clear Zone		14.3	(4)	
Bridges	New and Reconstructed Bridges	*Structural Capacity		HL-93	
		*Clear Roadway Width		44' (5)	
	Existing Bridges to Remain in Place	*Structural Capacity		HS-20 (6)	
		*Clear Roadway Width		44' (5)	
	*Vertical Clearance (Arterial Under) (7a)	New/Replaced Overpassing Bridges (7b)		12.6	17'-0"
		Existing Overpassing Bridges			16'-0"
		Pedestrian Bridges			18'-0"
		Overhead Signs			17'-6"
	Clearance (Arterial Over)	*Railroads		12.6	23'-0"
Underpass Width		13.5.2	Traveled Way plus Clear Zone		

*Controlling design criteria (see Section 9.2).

GEOMETRIC DESIGN CRITERIA FOR RURAL FOUR-LANE ARTERIALS (New Construction/Reconstruction)

Figure 20.2C

**GEOMETRIC DESIGN CRITERIA FOR RURAL FOUR-LANE ARTERIALS
(New Construction/Reconstruction)**

Footnotes to [Figure 20.2C](#)

- (1) Travel Lane Width. On reconstructed arterials, an existing 22-foot traveled way may be retained based on an engineering study.
- (2) Shoulder (Total Width). Where guardrail is required, increase the shoulder width an additional 3.5 feet.
- (3) Shoulder Cross Slopes. For paved shoulders wider than 2 feet, the shoulder cross slope should be 4.17 percent.
- (4) Clear Zone. The clear zone will vary according to design speed, traffic volumes, side slopes and horizontal curvature.
- (5) Bridges (Clear Roadway Width). Clear roadway bridge widths are measured from face to face of parapets or rails. Bridge widths are normally defined as the sum of the approach traveled way width plus the shoulder width on each side.
- (6) Existing Bridges to Remain in Place. An existing structure with a HS-20 capacity may be retained if it is not deficient.
- (7) Vertical Clearance (Arterial Under).
 - a. The clearance must be available over the traveled way and any paved shoulders.
 - b. Table value includes allowance for future overlays.

Design Element	Manual Section	Design Speed					
		50 mph	55 mph	60 mph	65 mph	70 mph	
* Stopping Sight Distance (1)	10.1	425'	495'	570'	645'	730'	
Passing Sight Distance	10.2	1835'	1985'	2135'	2285'	2480'	
Intersection Sight Distance (2)	10.4	555'	610'	665'	720'	775'	
*Minimum Radii	$e_{min} = 8\%$	–	965'	1205'	1485'	1820'	
	$e_{max} = 6\%$	835'	–	–	–	–	
*Superelevation Rate (3)	11.3	6%	8%	8%	8%	8%	
*Horizontal Sight Distance (4)	11.4	27'	32'	34'	35'	36'	
*Vertical Curvature (K-values) (5)	Crest	12.5	84	114	151	193	247
	Sag	12.5	96	115	136	157	181
*Maximum Grade (6)	Level	12.3.1	4%	4%	3%	3%	3%
	Rolling	12.3.1	5%	5%	4%	4%	4%
	Mountainous	12.3.1	7%	6%	6%	5%	5%
Minimum Grade (7)	12.3.2	0.5%					

* Controlling design criteria (see [Section 9.2](#)).

- (1) Stopping Sight Distance. Table values are for passenger cars on level grade.
- (2) Intersection Sight Distance. Table values are for passenger cars for assumed conditions described in [Figure 10.4C](#). See [Section 10.4](#) for truck values.
- (3) Superelevation Rate. See [Section 11.3](#) for superelevation rates based on e_{max} , design speed, and radii of horizontal curves. For horizontal curves to remain in place, an e_{max} of 8 percent may be considered to remain in place. Where a crossroad intersection lies within the limits of a mainline horizontal curve, see [Figure 11.3A](#) for the maximum superelevation rates allowed on the mainline curve.
- (4) Horizontal Sight Distance. Table values provide the necessary middle ordinate assuming the maximum radii and stopping sight distance.
- (5) Vertical Curvature (K-Value). K-values are based on the level stopping sight distances.
- (6) Maximum Grade. Grades 1 percent steeper may be allowed to remain in place for existing roadways.
- (7) Minimum Grade. Longitudinal gradients of 0 percent may be acceptable on some pavements that have cross slopes that insure adequate drainage. Special ditch grades may be necessary to insure proper project runoff management.

ALIGNMENT CRITERIA FOR RURAL FOUR-LANE ARTERIALS
Figure 20.2D

20.3 REFERENCES

1. *A Policy on Geometric Design of Highways and Streets*, AASHTO, 2001.
2. *Highway Safety Design and Operations Guide*, AASHTO, 1997.
3. *Roadside Design Guide*, AASHTO, 2002.
4. *Highway Capacity Manual 2000*, TRB, 2000.
5. *Low Cost Methods for Improving Traffic Operations on Two-Lane Roads*, Report No. FHWA-IP-87-2, FHWA, 1987.

Table of Contents

<u>Section</u>	<u>Page</u>
21.1 SUBURBAN/URBAN FUNCTIONAL CLASSIFICATIONS	21.1(1)
21.1.1 Arterials (Principal and Minor)	21.1(1)
21.1.2 Collectors	21.1(2)
21.2 GENERAL DESIGN ELEMENTS	21.2(1)
21.2.1 Traffic	21.2(1)
21.2.2 Level of Service	21.2(1)
21.2.3 Design Speed	21.2(2)
21.2.4 Sight Distances	21.2(2)
21.2.5 Typical Sections	21.2(2)
21.2.6 Medians	21.2(7)
21.2.7 Two-Way Left Turn Lane (TWLTL)	21.2(7)
21.2.7.1 Guidelines	21.2(7)
21.2.7.2 Design Criteria	21.2(10)
21.2.8 Parking Lanes	21.2(11)
21.2.8.1 Guidelines	21.2(11)
21.2.8.2 On-Street Parking Types	21.2(11)
21.2.8.3 Design	21.2(12)
21.2.9 Curbs	21.2(14)
21.2.9.1 Usage	21.2(14)
21.2.9.2 Types	21.2(15)
21.2.9.3 Accessibility for the Disabled	21.2(15)
21.2.10 Sidewalks	21.2(15)
21.2.10.1 Guidelines	21.2(15)
21.2.10.2 Sidewalk Design Criteria	21.2(17)
21.3 TABLES OF DESIGN CRITERIA	21.3(1)
21.4 REFERENCES	21.4(1)

Chapter Twenty-one

SUBURBAN/URBAN STREETS

This Chapter provides guidance in the design of urban highways and streets. Information that is also applicable to these facilities is included in the following chapters:

- [Chapters 9, 10, 11, 12 and 13](#) provide guidance on the geometric design elements that are also applicable to these facilities.
- [Chapter 14](#) provides guidelines on roadside safety issues.
- [Chapter 15](#) provides information on the design of intersections, including left- and right-turn lanes and channelization.
- [Chapter 22](#) provides guidelines for local streets.

21.1 SUBURBAN/URBAN FUNCTIONAL CLASSIFICATIONS

21.1.1 Arterials (Principal and Minor)

These routes consist of a connected urban network of continuous routes. Minor arterials provide lower travel speeds, accommodate shorter trip lengths and lower traffic volumes and provide more access to property. Arterials have the following general characteristics:

- provide service to, through or around urban areas from rural minor arterial routes and may be connecting links;
- serve generally as an extension of a rural minor arterial highway and could be an expressway design, a major two-way city street or a one-way pair system;
- may warrant management of access to the highway;
- serve long distance traffic within a city by connecting major regional activity centers not served by connecting links or may provide service for trips of moderate length;
- urbanized areas should provide for significant urban and suburban travel demands (e.g., between central business districts (CBD) and outlying residential areas, between major inner city communities, or between major suburban centers);
- small urban areas may be limited in the number and extent of routes. The importance of these routes is primarily to serve the CBD and to accommodate through travel at an appropriate level of service;

- may be included in the National Highway System (NHS);
- may provide for an integrated network serving the entire urban area;
- may carry local bus routes and provide intracommunity continuity (but will not, for example, penetrate neighborhoods);
- urbanized areas are located at spacings which are closely related to the trip-end density characteristics of specific portions of the urban area. Principal arterial spacing may vary from 1 mile between routes in the densely developed central business district areas to 6 miles or more in suburban areas; and
- considered together with all urban arterial routes, minor arterials may be spaced between 2 and 3 miles in suburban fringes and as close as 1 mile in fully developed areas. Within the CBD, a spacing of 650 feet to ½ mile is typical.

21.1.2 Collectors

In urban areas, collector streets serve as intermediate links between the arterial system and points of origin and destination. These facilities typically have the following characteristics:

- provide both access and traffic circulation within residential neighborhoods and commercial and industrial areas;
- may penetrate residential neighborhoods or commercial/industrial areas to collect and distribute trips to and from the arterial system;
- in the CBD, may include the streets which are not classified as arterials;
- in fully developed areas, spacing generally provides approximately ½ mile between routes and, within the CBD, spacing generally provides between 650 feet and ½ mile; and
- may be urban extensions of rural collector routes.

21.2 GENERAL DESIGN ELEMENTS

21.2.1 Traffic

Traffic volumes are the primary consideration for widening existing two-lane highways and are a major factor in determining the geometric criteria for urban and suburban streets. The design traffic should be estimated for 20 years from the projected project completion date.

21.2.2 Level of Service

The LOS criteria for an urban street, as defined in the *Highway Capacity Manual*, is based on the travel speed along a segment or a section and the amount of control delay that occurs at signalized intersections. The *Highway Capacity Manual* divides urban streets into design categories that are different than the categories defined in AASHTO. These design categories are based on the posted speed limit, signal density, driveway/access-point density and other design features. The classes are designated by number (i.e., I, II, III, IV) and reflect unique combinations of street functions and design. The following provides the category and class descriptions:

1. High-Speed Design. The high-speed design represents an urban street with a very low driveway/access-point density, separate left-turn lanes and no parking. It may be a multilane divided or undivided, or a two-lane facility with shoulders. Signals are infrequent. Roadside development is low density, and the speed limit is typically 45 to 55 miles per hour. This design category includes many urban streets in the suburban settings.

The high-speed design is applicable to Class I principal arterials.

2. Suburban Design. The suburban design represents a street with a low driveway/access-point density, separate left-turn lanes and no parking. It may be a multilane divided or undivided, or a two-lane facility with shoulders. Signals are spaced for good progression (e.g., up to 5 signals per mile). Roadside development is low to medium density, and speed limits are usually 40 to 45 miles per hour.

The suburban design is applicable to Class II principal and minor arterials.

3. Intermediate Design. The intermediate design represents an urban street with a moderate driveway/access-point density. It may be a multilane divided or a one-way or two-lane facility. It may have some separate or continuous left-turn lanes and some portions where parking is permitted. It has a higher density of roadside development than the typical suburban design and usually has four to ten signals per mile. Speed limits are typically 30 to 40 miles per hour.

The intermediate design is applicable to:

- Class II principal arterials,
 - Class III minor arterials, or
 - Class IV minor arterials.
4. Urban Design. The urban design represents an urban street with a high driveway/access-point density. It frequently is an undivided one-way or two-way facility with two or more lanes. Parking is usually permitted. Generally, there are few separate left-turn lanes and some pedestrian interference is present. It commonly has 6 to 12 signals per mile. Roadside development is dense with commercial uses. Speed limits range from 25 to 35 miles per hour.

The urban design classification is applicable to:

- Class III principal arterials,
- Class IV principal arterials, or
- Class IV minor arterials.

For more information on the LOS analysis, see the *Highway Capacity Manual*.

21.2.3 Design Speed

Urban design speeds can range from 30 to 60 miles per hour, depending on available right of way, terrain, adjacent development, likely pedestrian presence and other site controls. Lower speeds apply in central business districts and in more developed areas, while higher speeds are more applicable to outlying suburban and developing areas.

21.2.4 Sight Distances

Adequate stopping sight distance, decision sight distance and intersection sight distance affects normal operational characteristics, particularly where roadways carry high-traffic volumes. Passing sight distance is generally not applicable to urban/suburban streets. See [Chapter 10](#) and the figures in [Section 21.3](#) for the applicable sight distances pertaining to urban arterials and collectors.

21.2.5 Typical Sections

[Figures 21.2A through 21.2C](#) present the typical cross sections for various urban facilities. [Figure 21.2D](#) provides a sample lane transition design from a two-lane to a four-lane facility.

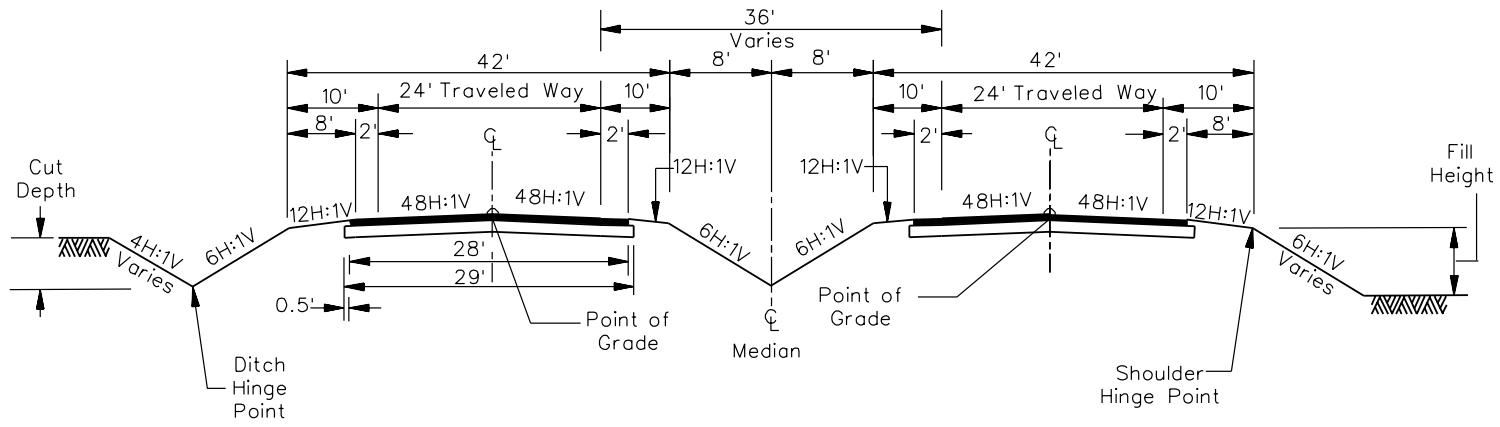

**TYPICAL FOUR-LANE SUBURBAN/URBAN STREET
(Depressed Median)**

Figure 21.2A

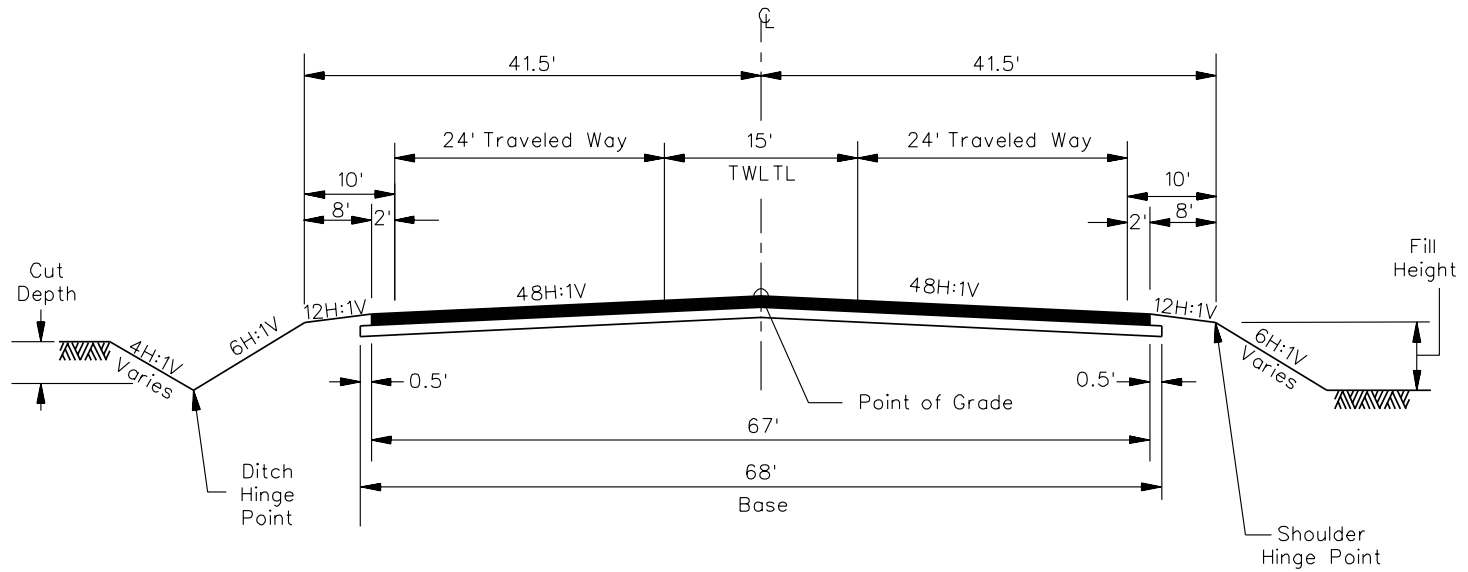

**TYPICAL FIVE-LANE URBAN STREET
(With Shoulders)**

Figure 21.2B

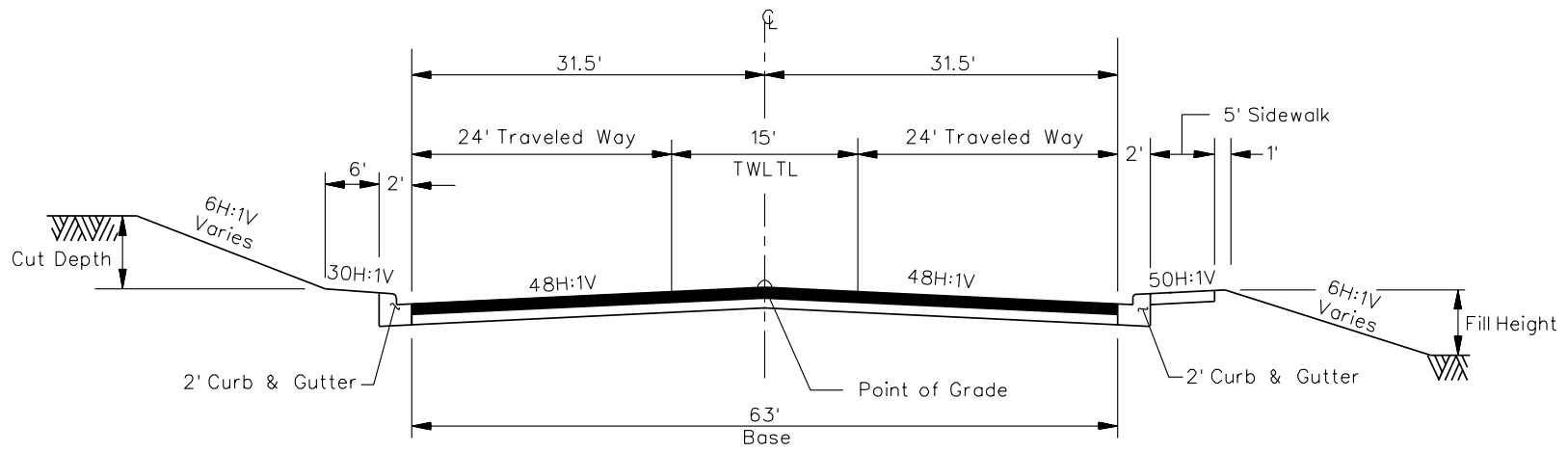

**TYPICAL FIVE-LANE URBAN STREET
(Curb and Gutter)**

Figure 21.2C

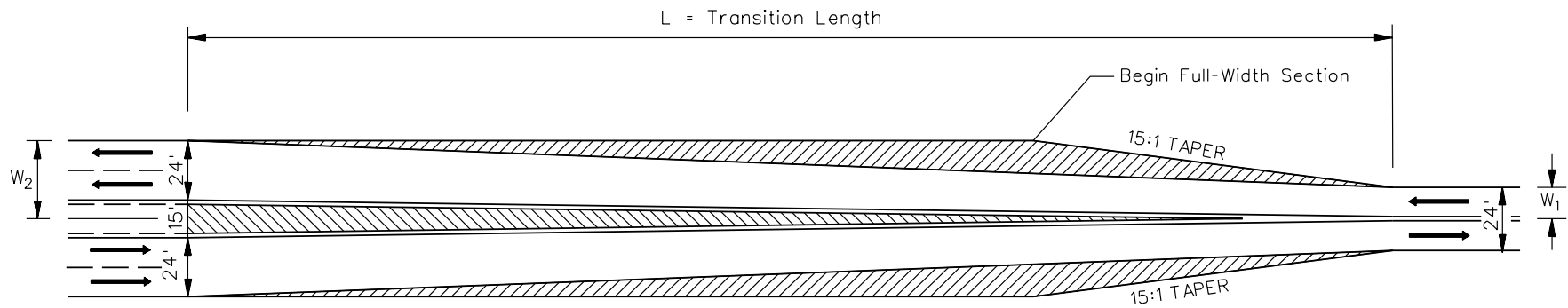
**Example 21.3(1)**

$$W = 31.5' - 12' = 19.5'$$

$$S = 45 \text{ mph}$$

$$L = 19.5' \times 45 \text{ mph} = 877.5'$$

$$L \text{ (ft)} = WS \text{ for } S > 40 \text{ mph or } WS^2/60 \text{ for } S \leq 40 \text{ mph}$$

$$W \text{ (ft)} = W_2 - W_1$$

$$S \text{ (mph)} = \text{Design Speed}$$

**LANE TRANSITION DESIGN
(Five-Lane TWLTL to Two-Lane)**

Figure 21.2D

21.2.6 **Medians**

The decision as to the median type to be used on a project should be made as early as possible. Urban medians may consist of one of the following:

1. **Flush/TWLTL Median.** The Two-Way, Left-Turn Lane (TWLTL) is the most common median type used by the Department for urban and suburban streets. Where there is insufficient room for a TWLTL or where a TWLTL is considered unnecessary, the designer may want to consider providing a painted flush median that may range from 4 to 12 feet. [Section 21.2.7](#) further discusses the use and design of the TWLTL.
2. **Depressed.** A depressed median is usually considered where managed access to the street and control of left-turn movements are desired.
3. **Raised/Planted Median.** A raised and/or planted median may be proposed for managing access. A raised median with plantings in the center may be proposed for aesthetic purposes. Insure adequate drainage is provided.

See [Section 13.4](#) for further guidance on the various types of medians that are used by the Department and the guidelines for median selection.

21.2.7 **Two-Way Left Turn Lane (TWLTL)**

21.2.7.1 **Guidelines**

The applicability of a TWLTL is a function of the traffic conditions that result from the adjacent land use. A TWLTL may perpetuate more strip development. For additional information on the use of a TWLTL design or flush alternating left-turn lanes along a street, see NCHRP 395 *Capacity and Operational Effects of Midblock Left-Turn Lanes*. Also consider the following guidelines:

1. **General.** Consider providing a TWLTL in:
 - areas with a high number of existing driveways per mile (e.g., 10 to 35 driveways total per mile on both sides of the street);
 - areas of existing high-density commercial development;
 - areas with substantial mid-block left turns; and/or
 - areas where space is not available for a depressed median and a need for protected left-turn lanes exists.

2. Highway Type. Two-lane and four-lane undivided urban or suburban arterials are the most common candidates for the implementation of a TWLTL design. Once these streets are reconstructed, they are commonly referred to as three-lane and five-lane facilities, respectively.
3. Traffic Volumes. Traffic volumes and the percent of left turns in each direction are significant factors in the consideration of a TWLTL. As general guidance, consider the following:
 - a. Two-Lane Facilities. On existing two-lane roadways, a TWLTL design will often be advantageous for traffic volumes between 5,000 and 14,000 ADT.
 - b. Four-Lane Facilities. On existing four-lane undivided highways, a TWLTL will often be advantageous for traffic volumes greater than 10,000 ADT. [Figure 21.2E](#) provides an example lane transition design for a four-lane to a five-lane TWLTL facility.
 - c. Six-Lane Facilities. The decision on whether to provide a TWLTL will be determined on a case-by-case basis (seven-lane facility).
 - d. Pedestrians. Pedestrian crossing volumes are also a consideration because of the large paved area that must be traversed when a TWLTL is present (i.e., no pedestrian refuge exists). There may be significant delays for vehicles at signalized intersections to accommodate pedestrians crossing the highway in one movement. A short raised-curb median may provide a refuge area for pedestrians to cross the highway in two movements.
4. Speed. The design speed of an urban street is a major factor in TWLTL applications. Experience indicates that design speeds from 25 to 45 miles per hour will properly accommodate TWLTL operations.
5. Crash History. On urban or suburban arterials without medians, traffic conflicts often result because of a significant number of mid-block left turns combined with significant opposing traffic volumes. This may lead to a disproportionate number of mid-block, rear-end and/or sideswipe crashes. The inclusion of a median for left turns is likely to reduce these types of crashes. Review and evaluate the available crash data to determine if disproportionately high numbers of these crashes are occurring.

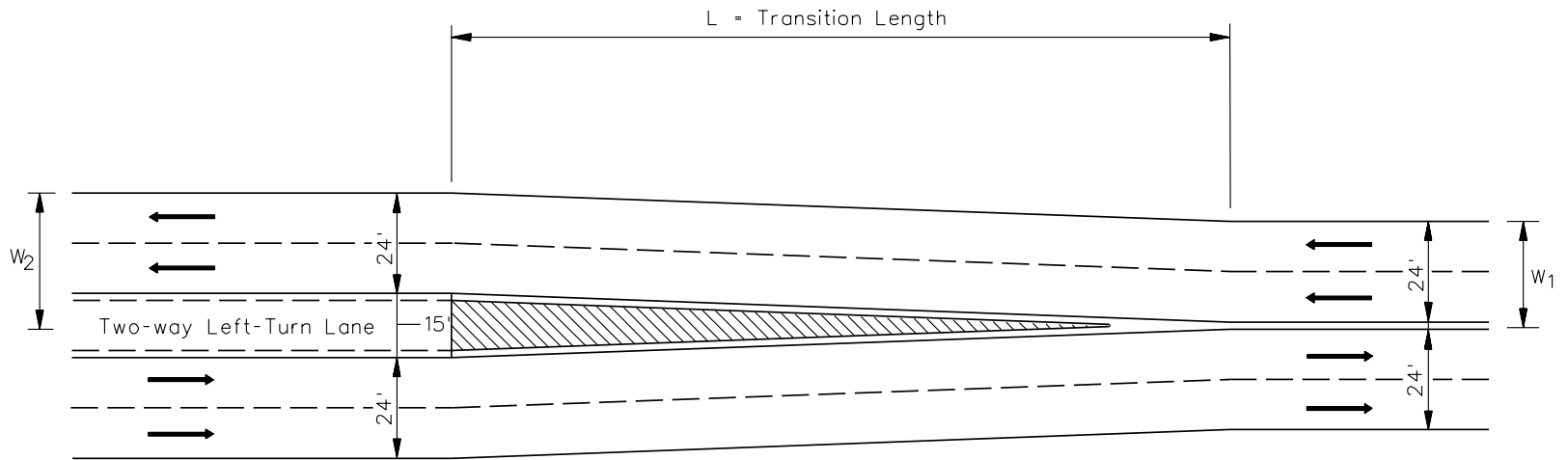

$$L \text{ (ft)} = WS \text{ for } S > 40 \text{ mph or } WS^2 / 60 \text{ for } S \leq 40 \text{ mph}$$

$$W \text{ (ft)} = W_2 - W_1$$

S (mph) = Design Speed

**LANE TRANSITION DESIGN
(Five-Lane TWLTL to Four-Lane)**

Figure 21.2E

21.2.7.2 Design Criteria

When designing TWLTL, see the design criteria provided in [Figures 21.3A](#) and [21.3C](#). When adding a TWLTL to an existing facility, consider the following:

1. Median Width. SCDOT generally requires a 15-foot TWLTL. To obtain the TWLTL width, the road designer should consider the following:
 - reducing the width of existing through lanes and analyzing side road radius returns,
 - eliminating existing parking lanes and reconstructing curb and gutter and sidewalks,
 - reconstructing existing shoulders and ditches,
 - replacing existing shoulders and ditches with curb and gutter,
 - eliminating existing buffer areas behind curbs and reconstructing curb and gutter and sidewalks, and/or
 - acquiring additional right of way to expand the pavement width by the amount needed for the TWLTL.
2. Intersection Treatment. At intersections with public roads, consider the following:
 - a. Side Streets/Major Entrances. At intersections where an exclusive left-turn lane is desirable, omit the pavement markings through the intersection.
 - b. Turning Volumes. The left-turn demand into intersecting side streets is a factor in determining the appropriate length of the left-turn lane. As a general rule in urban areas, the minimum storage length will govern the length of left-turn lanes; see [Section 15.5.2](#).
 - c. Length of TWLTL. The TWLTL should have sufficient length to operate properly, and the type of intersection treatments will determine the length of the TWLTL. The final decision on the length of the TWLTL will be based on site conditions.
 - d. Operational/Safety Factors. Provide proper signing and stopping sight distance at the beginning and end of each TWLTL. Where a number of turning movements are expected into and out of entrances located close to a major intersection, it is desirable to provide a channelized design for the exclusive left-turn lane; see [Section 15.5](#).

21.2.8 Parking Lanes

This Section only applies to on-street parking designs. For off-street parking design, the road designer should review the Institute of Transportation Engineers' publication *Traffic Engineering Handbook*.

21.2.8.1 Guidelines

Adjacent land use may create a demand for on-street parking along an urban street. Parking lanes provide convenient access for motorists to businesses and residences. However, on-street parking reduces capacity, impedes traffic flow and increases the crash potential.

The decision to retain existing on-street parking or to introduce on-street parking will be based on a case-by-case assessment in cooperation with the local community. Evaluate the following factors:

- prior crash experience or potential safety concerns;
- impacts on the capacity of the facility;
- current or predicted demand for parking;
- actual needs versus existing number of spaces;
- alternative parking options (e.g., off-street parking);
- input from local businesses;
- impacts on right of way;
- impacts on bicyclists and pedestrians;
- accessibility for disabled individuals;
- construction costs; and
- projected traffic volumes.

21.2.8.2 On-Street Parking Types

The two basic types of on-street parking are parallel and angle parking. Parallel parking is the preferred arrangement where street space is limited and traffic capacity is a major factor. Angle parking provides more spaces per linear foot than parallel parking, but a greater cross street width is necessary for its design. The total entrance and exit time for parallel parking exceeds that required for angle parking. Parallel parking also requires a vehicle to stop in the travel lane and await an opportunity to back into the parking space. However, angle parking requires the vehicle to back into the lane of travel when adjacent parked vehicles may restrict sight distance and where this maneuver may surprise an approaching motorist.

The following summarizes the general practice on the selection of parking lane type:

1. General. Parallel parking is preferred to angle parking.
2. Existing Angle Parking. Angle parking will not be permitted on any Federal-aid or State highway unless the Department determines that the roadway is of sufficient width to permit angle parking without interfering with the free movement of traffic. A local authority may by ordinance permit angle parking on a roadway. SCDOT prefers to relocate parking off-site or to convert angle parking to parallel parking. Consult with the local community before selecting an option.
3. New Parking. Where new on-street parking will be introduced, only parallel parking will be acceptable.

21.1.1.1 Design

The following summarizes the design criteria for on-street parking:

1. Stall Width. All parallel parking stalls should be 8 to 12 feet wide. For parallel parking, stall widths are measured from the edge of traveled way to the gutter line. For angle parking, stall widths will generally **range between 8.5 and 9 feet**.
2. Stall Layout. Figure 21.2F provides the layout criteria for parking stalls for various configurations. The figure also indicates the number of stalls which can be provided for each parking configuration for a given curb length. For angle parking, desirably, the roadway width allocated to parking will be the maneuvering space as shown in Figure 21.2F exclusive of the through travel lane. The maneuvering space distance is that width needed by a parked vehicle to back onto the street when exiting the stall. However, in restricted areas a portion of the maneuvering dimension may be required for the through travel lane, thereby reducing the roadway width allocated to angle parking.
3. Cross Slope. The cross slope of the parking lane should match that of the adjacent through travel lane, typically 2.08 percent. However, exceptions are allowed for cross slopes between 2.08 percent and 4 percent to fit actual field conditions. The slope of the parking lane may not be flatter than that of the adjacent through lane.
4. Accessibility for Disabled Individuals. A certain number of on-street parking spaces must be provided for accessibility for the disabled. Their design must meet the accessibility design criteria discussed in Section 17.1.
5. Intersection Curb Radii. Parking may need to be restricted a certain distance from intersections to allow the design vehicle (typically a WB-62) to properly negotiate the right turn. See Section 15.3 for specific information.

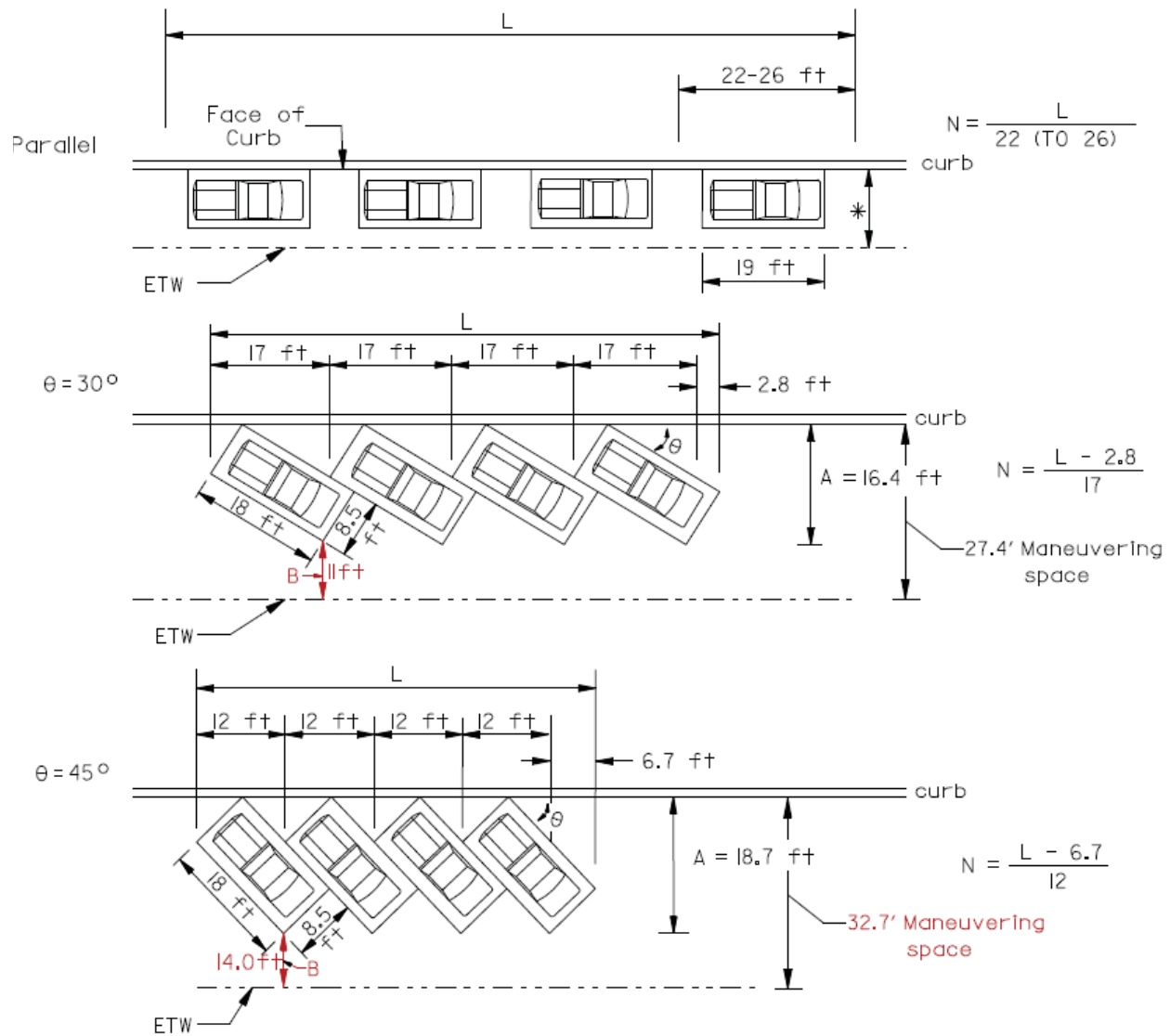

- Key:
- L = given curb length with parking spaces, feet
 - N = number of parking spaces over distance L
 - A = required distance between face of curb and back of stall, assuming that bumper of parked car does not extend beyond curb face, feet
 - B = minimum clear distance needed for a parked vehicle to back out of stall while clearing adjacent parked vehicles, feet
 - ETW = Edge of Traveled Way

*See Figures 21.3A and 21.3C for parking lane widths

Revised maneuvering space dimension for 45 degree parking – 9-2008
 Added dimensions “B” and “B” to 30 and 45 degree parking 9-2008

PARKING CONFIGURATIONS
Figure 21.2F

6. Location. For most sites, conduct a parking occupancy turnover study and a sight distance evaluation. In addition to State and local regulations, when locating parking spaces consider the following:
 - a. Prohibit parking within 20 feet of any crosswalk.
 - b. Prohibit parking at least 10 feet from the beginning of the curb radius at mid-block approaches (e.g., alleys, driveways).
 - c. Prohibit parking within 50 feet of the nearest rail of a railroad/highway crossing.
 - d. Prohibit parking from areas designated by local traffic and enforcement regulations (e.g., near school zones, fire hydrants). See local ordinances for additional information on parking restrictions.
 - e. Prohibit parking near bus stops (see [Section 17.5](#)).
 - f. Prohibit parking within 30 feet on the approach leg to any intersection with a flashing beacon, stop sign or traffic signal.
 - g. Prohibit parking on bridges or within a highway tunnel.
 - h. Eliminate parking across from a T- intersection.
 - i. Prohibit parking in the intersection sight triangle.

21.2.9 Curbs

21.2.9.1 Usage

Curbs are often used on urban facilities to control drainage, delineate the pavement edge, channelize vehicular movements, control access, limit right of way needs, provide separation between vehicles and pedestrians and present an attractive appearance. Curbs are not generally used in rural areas. For urban and suburban areas, determining if curbs will be used depends upon many variables, and the decision will be made on a case-by-case basis. Evaluate the following factors to determine whether a curbed section is preferred:

- local preference,
- drainage impacts,
- construction costs,
- impacts on maintenance operations,
- roadside safety impacts (see [Chapter 14](#)),
- sidewalk guidelines (see [Section 21.2.10](#)),
- control of access to abutting properties,

- impacts on traffic operations,
- right of way restrictions, and
- vehicular speeds.

Curbs used along the outside pavement edges serve a variety of functions (e.g., drainage control, delineating edges of pavement and pedestrian walkways, aesthetics, reduce rights of way). Curbs are also used as aids in channelizing vehicle movement at intersections as well as controlling access points and providing lateral support of the roadway or shoulder pavement. The use of curbs predominates in urban areas as opposed to rural.

21.2.9.2 Types

There are two basic types of curbs, the vertical curb and sloping curb. Either may be constructed with an integral gutter to form a curb and gutter section. Curbs are constructed of concrete. They can be cast-in-place or extruded.

Vertical curbs are normally 6 inches in height with steep vertical faces. They are intended to discourage vehicles from leaving the traveled way. Vertical curbs generally should not be used adjacent to travel lanes where design speeds exceed 45 miles per hour. If the design speed is greater than 45 miles per hour, use a sloping curb and place it on the outside edge of the shoulder. Sloping curbs are generally 6 inches with a slope face. See the *SCDOT Standard Drawings* for details of curb and gutter.

Where curb and gutter is used, whether vertical or sloping curb, the gutter portion is not considered to be a part of the traveled way.

21.2.9.3 Accessibility for the Disabled

Curbs should be designed with curb ramps at all pedestrian crosswalks to provide adequate access for the safe and convenient movement of physically disabled individuals. See [Section 17.1.10](#) for details on the design and location of curb ramps.

21.2.10 Sidewalks

21.2.10.1 Guidelines

Sidewalks should, at a minimum, be located along streets and roadways where there is pedestrian access to schools, libraries, parks, shopping areas, bus stops, industrial plants or where heavy pedestrian concentrations exist along the roadway. The following guidance will determine the need for sidewalks in the project design:

1. Sidewalks Currently Exist (Roadway or Bridge). Where sidewalks currently exist along a roadway, the sidewalk will normally be replaced. If a bridge with an existing sidewalk is replaced or rehabilitated, the sidewalk will normally be replaced.
2. Sidewalks Currently Do Not Exist (Roadway). The need for sidewalks will be determined on a case-by-case basis in cooperation with the local community. In general, the designer should consider providing sidewalks along any roadway where pedestrians normally move or would be expected to move if they had a sidewalk available (i.e., a latent demand exists). In addition, sidewalks may be required at specific sites even if they are not needed along the entire length of the roadway. These include points of community development (e.g., schools), local businesses, shopping centers and industrial plants that result in pedestrian concentrations along the highway.

If curb and gutter are included in the roadway section, sidewalks will be provided unless there is a reason not to. See [Section 21.2.9](#) for curb guidelines.

3. Sidewalks Currently Do Not Exist (Bridge). If a bridge without a sidewalk will be replaced or rehabilitated and if existing sidewalks approach the bridge, a sidewalk will normally be included in the bridge project. Even if sidewalks are not currently on the approaching roadway, they may still be necessary on the bridge if the approach roadway is a candidate for future sidewalks according to the discussion in Comment 2.

As a more general statement, if there is curb and gutter on the roadway approach, the bridge should include sidewalks.

4. Sidewalks Currently Do Not Exist (Underpasses). Sidewalks should be provided through the underpass if the approach roadway will have sidewalks.

A bridge reconstruction project may involve major work on or the replacement of the bridge substructure. If the bridge passes over a roadway, the bridge should allow space for the future addition of sidewalks through the underpass based on the eventual need for sidewalks on the roadway approaching the underpass.

5. One Side vs. Two Sides. Sidewalk requirements for each side of the roadway or bridge will be evaluated individually (i.e., placing a sidewalk on each side will be based on the specific characteristics of that side).
6. Approval. For all projects in urban areas, the Program Manager will make the final decision on sidewalk requirements. This applies to the roadway, bridges and underpasses.

21.2.10.2 Sidewalk Design Criteria

In determining the sidewalk design, the road designer should consider the following:

1. Typical Widths. The minimum sidewalk width is 5 feet. However, wider sidewalks may be considered along streets with schools or where on-street parking and bus stop areas are located. In commercial areas, wider sidewalks may allow for the increased volume of pedestrian traffic normally associated with these areas. Sidewalk usage and widths are determined using the *Highway Capacity Manual*.

The road designer should also evaluate the width considering compatibility with local city and community criteria.

2. Placement. When adding sidewalks to an existing facility, place them a minimum of 0.5 foot from the right of way line.
3. Appurtenances. The designer should also consider the impacts of roadside appurtenances within the sidewalk (e.g., fire hydrants, parking meters, utility poles, signs). These elements will reduce the effective width because they interfere with pedestrian activity. Preferably, place these appurtenances behind the sidewalk. If they are placed within the sidewalk, the sidewalk should have a minimum clear width of 3 feet; desirably, a 5-foot clear width should be provided. The clear width will be measured from the edge of the appurtenance to the edge of the sidewalk. A 3-foot minimum is necessary to meet the disabled accessibility requirements; see [Section 17.1](#).
4. Pedestrian Crossings. Pedestrian crossings are normally relegated to intersection locations. Crossing at intersections should be located at the beginning and end of curb return radii in order to keep the crossing distance to a minimum. In areas where there are curbs, ramps at crossing locations are placed for the disabled. See the *SCDOT Standard Drawings*. For additional guidance, see [Section 17.1](#).
5. Cross Slope. The maximum cross slope on the sidewalk is 2 percent sloped towards the roadway.
6. Buffer Areas. If the available right of way is sufficient, buffer areas between the curb and sidewalk are desirable. The buffer area should be at least 2 feet wide to be effective. This space provides for street and highway hardware (e.g., signs, hydrants, mailboxes) and allows for greater distance between pedestrians and moving traffic or the opening of doors of parked cars.
7. Pavement Material. Sidewalks are generally constructed of concrete and are 4 inches thick except at driveways where the thickness is increased to 6 inches.

8. Bridges. The Bridge Section is responsible for the dimensioning and structural design of all sidewalks on bridges.

21.3 TABLES OF DESIGN CRITERIA

Figures 21.3A through 21.3D present the Department's design and alignment criteria for suburban/urban arterials and suburban/urban collectors. The designer should consider the following when using these figures:

1. Functional Classification. To determine the latest functional classification of a facility, the designer should contact Road Data Services.
2. Applicability. Note that some of the cross-section elements included in the figures (e.g., TWLTL) are not automatically warranted in the project design. The values in the figures only apply after the decision has been made to include the element in the highway cross section.
3. Manual Section References. These figures are intended to provide a concise listing of design values for easy use. However, the designer should review the *Manual* section references for more information on the design elements.
4. Footnotes. The figures include many footnotes, which are identified by a number in parentheses (e.g., (3)). The information in the footnotes is critical to the proper use of the design tables.
5. Controlling Design Criteria. The figures provide an asterisk to indicate controlling design criteria. [Section 9.2](#) discusses this in more detail and presents the process for approving design exceptions to controlling criteria.

	Design Element		Manual Section	Design Criteria	
Design Controls	Design Forecast Year		9.6.2	20 years	
	*Design Speed		9.5.2	35 to 60 mph	
	Access Control		9.8	Limited/Controlled by Regulation	
	Level of Service		9.6.4	Desirable: C	
Cross Section Elements	*Travel Lane Width		13.2.3	12'	
	*Right Shoulder Width	Total Width	13.2.4	10' or Curb and Gutter	
		Paved Width		2' or Curb and Gutter	
	*Left Shoulder Width	Total Width		10' or Curb and Gutter	
		Paved Width		2' or Curb and Gutter	
	Auxiliary Lanes	Lane Width		12'	
		Shoulder Width	Total Width	Des.: 10' Min.:4' or Curb and Gutter	
			Paved	2' or Curb and Gutter	
	Parking Lane Width		21.2.8	12' (1)	
	Cross Slope	*Travel Lane		13.2.3.3	2.08%
		Auxiliary Lane		13.2.5	2.08% (2)
		*Shoulder	Paved	13.2.4.3	2.08% (3)
			Unpaved		8.33%
	Bicycle	Lane Width		13.2.3	4' (4)
		Shared Roadway Width			14' Outside Travel Lane
	Curb and Gutter	Type (5)		21.2.9	Vertical or Sloping
		Width			2'
	Sidewalk Width		21.2.10	5'	
Median Width	Depressed		13.4.2.3	36'	
	TWLTL		21.2.7	15'	
	Flush		13.4.2.1	Des: 12' Min: 4'	
Roadway Elements	Side Slopes	Cut Section	Foreslope	6H:1V	
			Ditch Type	V-Ditch	
			Back Slope	4H:1V to 2H:1V (6)	
		Fill Section	0' – 5'	6H:1V	
			5' – 10'	4H:1V	
			> 10'	2H:1V	
	Median Slopes	Depressed		13.4.2	6H:1V
Flush/TWLTL		21.2.7	2.08%		
Clear Zone		14.3	(7)		

*Controlling design criteria (see Section 9.2)

**GEOMETRIC DESIGN CRITERIA FOR SUBURBAN/URBAN ARTERIALS
(New Construction/Reconstruction)**

Figure 21.3A

Design Element		Manual Section	Design Criteria	
Bridges	New and Reconstructed Bridges	*Structural Capacity	HL-93	
		*Clear Roadway Width	(8)	
	Existing Bridges to Remain in Place	*Structural Capacity	HS-20	
		*Clear Roadway Width	(8)	
	*Vertical Clearance (Arterial Under) (9a)	New/Replaced Overpassing Bridges (9b)	12.6	17' - 0"
		Existing Overpassing Bridges		16' - 0"
		Pedestrian Bridges		18' - 0"
		Overhead Signs		17' - 6"
	Clearance (Arterial Over)	*Railroads	12.6	23' - 0"
		Underpass Width	13.5.2	Traveled Way Plus Clear Zone

*Controlling design criteria (see [Section 9.2](#)).

**GEOMETRIC DESIGN CRITERIA FOR SUBURBAN/URBAN ARTERIALS
(New Construction/Reconstruction)**

Figure 21.3A

(Continued)

GEOMETRIC DESIGN CRITERIA FOR SUBURBAN/URBAN MULTILANE ARTERIALS (New Construction/Reconstruction)

Footnotes to Figure 21.3A

- (1) Parking Lane Width. A parking lane width as narrow as 10 feet may be acceptable.
- (2) Auxiliary Lane Cross Slope. For auxiliary lanes adjacent to two travel lanes sloped in the same direction, use a cross slope of 2.78 percent.
- (3) Shoulder Cross Slope. For paved shoulders greater than 2 feet, the shoulder cross slope should be 4.17 percent.
- (4) Bicycle (Lane Width). For design speeds greater than 45 miles per hour, bike lane width should be increased in accordance with AASHTO *Guide for the Development of Bicycle Facilities*.
- (5) Curb and Gutter (Type). If curb and gutter is used on streets with design speeds greater than 45 miles per hour, place the curb and gutter outside of the shoulder and use a sloping curb.
- (6) Side Slopes. Generally on curb and gutter sections, a maximum slope of 2H:1V is used.
- (7) Clear Zone. The clear zone will vary according to design speed, traffic volumes, side slopes and horizontal curvature.
- (8) Bridge Widths. Clear roadway bridge widths are measured from face to face of parapets or rails. Bridge widths are normally defined as the sum of the approach traveled way width, right and left shoulders and median width, where applicable. For curbed sections, the clear roadway width will be the curb-to-curb width plus the sidewalk width on one or both sides.
- (9) Vertical Clearance (Arterial Under).
 - a. The clearance must be available over the traveled way, shoulders, and any anticipated future widening.
 - b. Table value includes allowance for future overlays.

Design Element		Manual Section	Design Speed					
			35 mph	40 mph	45 mph	50 mph	55 mph	60 mph
*Stopping Sight Distance (1)		10.1	250'	305'	360'	425'	495'	570'
Decision Sight Distance (2)		10.3	590'	690'	800'	910'	1030'	1150'
Intersection Sight Distance (3)		10.4	390'	445'	500'	555'	610'	665'
*Minimum Radii	e _{max} = 8%	11.2.3	–	–	–	–	965'	1205'
	e _{max} = 6%		380'	510'	660'	835'	–	–
	e _{max} = 4%		425'	565'	735'	–	–	–
*Superelevation Rate (4a)		11.3	4% or 6% (4b)	4% or 6% (4b)	4% or 6% (4b)	6%	8%	8%
*Horizontal Sight Distance (Middle Ordinate) (5)		11.4	23'	24'	25'	30'	32'	34'
*Minimum Vertical Curvature (K-values) (6)	Crest	12.5	29	44	61	84	114	151
	Sag		49	64	79	96	115	136
*Maximum Grade	Level	12.3	7%	7%	6%	6%	5%	5%
	Rolling		8%	8%	7%	7%	6%	6%
	Mountainous		10%	10%	9%	9%	8%	8%
Minimum Grade		12.3	Des.: 0.5% Min.: 0.3% (Curb & Gutter)					

*Controlling design criteria (see Section 9.2).

- (1) Stopping Sight Distance. Table values are for passenger cars on level grade.
- (2) Decision Sight Distance. Table values are for a stop on an urban road, Avoidance Maneuver B, as described in Figure 10.3A.
- (3) Intersection Sight Distance. Table values are for passenger cars for assumed conditions described in Figure 10.4C.
- (4) Superelevation Rate.
 - a. See Section 11.3 for superelevation rates based on e_{max}, design speed and radii of horizontal curves.
 - b. The 6 percent superelevation rate should only be used on suburban arterials.
- (5) Horizontal Sight Distance. Table values provide the necessary middle ordinate assuming, the maximum radii and stopping sight distance.
- (6) Vertical Curvature (K-values). K-values are based on level stopping sight distances.

ALIGNMENT CRITERIA FOR SUBURBAN/URBAN ARTERIALS

Figure 21.3B

Design Element			Manual Section	Design Criteria	
Design Controls	Design Forecast Year		9.6.2	20 years	
	*Design Speed		9.5.2	30 to 45 mph	
	Access Control		9.8	Controlled by Regulation	
	Level of Service		9.6.4	Desirable: C	
Cross Section Elements	*Travel Lane Width		13.2.3	12'	
	*Shoulder Width	Total Width	13.2.4	8' or Curb and Gutter	
		Paved Width		2' or Curb and Gutter	
	Auxiliary Lanes	Lane Width		12'	
		Shoulder Width	Total Width	Des.: 8' Min.: 4' or Curb and Gutter	
			Paved		2' or Curb and Gutter
	Parking Lane Width		21.2.8	12' (1)	
	Cross Slope	*Travel Lane		13.2.3.3	2.08%
		Auxiliary Lane		13.2.5	2.08% (2)
		*Shoulder	Paved	13.2.4.3	2.08% (3)
			Unpaved		8.33%
	Bicycle	Lane Width		13.2.3	4' (4)
		Shared Roadway Width			14' Outside Travel Lane
	Curb and Gutter	Type (5)		21.2.9	Vertical or Sloping
		Width			2'
Sidewalk Width		21.2.10	5'		
Median Width	TWLTL		21.2.7	15'	
	Flush		13.4.2.1	Des: 12' Min: 4'	
Roadway Elements	Side Slopes	Cut Section	Foreslope	6H:1V	
			Ditch Width	V-Ditch	
			Back Slope	4H:1V to 2H:1V	
		Fill Section	0' – 5'	6H:1V	
			5' – 10'	4H:1V	
			> 10'	2H:1V	
	Median Slopes		Flush/TWLTL	21.2.7	2.08%
Clear Zone			14.3	(6)	
Bridges	New and Reconstructed Bridges	*Structural Capacity		HL-93	
		*Clear Roadway Width		13.5.1.1	(7)
	Existing Bridges to Remain in Place	*Structural Capacity		HL-15	
		*Clear Roadway Width		13.5.1.1	(7)
	*Vertical Clearance (Collector Under) (8a)	New/Replaced Overpassing Bridges (8b)		12.6	16' - 0"
		Existing Overpassing Bridges			16' - 0"
		Pedestrian Bridges			18' - 0"
		Overhead Signs			17' - 6"
Clearance (Collector Over)	*Railroads		12.6	23' - 0"	
	Underpass Width		13.5.2	Traveled Way Plus Clear Zone	

*Controlling design criteria (see Section 9.2).

**GEOMETRIC DESIGN CRITERIA FOR SUBURBAN/URBAN COLLECTORS
(New Construction/Reconstruction)
Figure 21.3C**

GEOMETRIC DESIGN CRITERIA FOR SUBURBAN/URBAN COLLECTORS (New Construction/Reconstruction)

Footnotes to [Figure 21.3C](#)

- (1) Parking Lane Width. A parking lane width as narrow as 8 feet may be acceptable.
- (2) Auxiliary Lanes. For auxiliary lanes adjacent to two travel lanes sloped in the same direction, use a cross slope of 2.78 percent.
- (3) Shoulder Cross Slope. For paved shoulders greater than 2 feet, the shoulder cross slope should be 4.17 percent.
- (4) Bicycle (Lane Width). For design speeds greater than 45 miles per hour, bike lane width should be increased in accordance with AASHTO guidelines.
- (5) Curb and Gutter (Type). If curb and gutter is used on streets with design speeds greater than 45 miles per hour, place the curb and gutter outside of the shoulder and use a sloping curb.
- (6) Clear Zone. The clear zone will vary according to design speed, traffic volumes, side slopes and horizontal curvature.
- (7) Bridge Widths. Clear roadway bridge widths are measured from face to face of parapets or rails. Bridge widths are normally defined as the sum of the approach traveled way width, shoulders and median width, where applicable. For curbed sections, the clear roadway width will be the curb-to-curb width plus the sidewalk width on one or both sides.
- (8) Vertical Clearance (Collector Under).
 - a. The clearance must be available over the traveled way, shoulders, and any anticipated future widening.
 - b. Table value includes allowance for future overlays.

Design Element	Manual Section	Design Speed				
		30 mph	35 mph	40 mph	45 mph	
*Stopping Sight Distance (1)	10.1	200'	250'	305'	360'	
Decision Sight Distance (2)	10.3	490'	590'	690'	800'	
Intersection Sight Distance (3)	10.4	335'	390'	445'	500'	
*Minimum Radii	11.2.3	$e_{\max} = 6\%$	275'	380'	510'	660'
		$e_{\max} = 4\%$	305'	425'	565'	735'
*Superelevation Rate (4)	11.3	4% or 6%	4% or 6%	4% or 6%	4% or 6%	
*Horizontal Sight Distance (5)	11.4	22'	23'	24'	25'	
*Minimum Vertical Curvature (K-values) (6)	12.5	Crest	19	29	44	61
		Sag	37	49	64	79
*Maximum Grade (7)	12.3	Level	9%	9%	9%	8%
		Rolling	11%	10%	10%	9%
		Mountainous	12%	12%	12%	11%
Minimum Grade	12.3	Des.: 0.5% Min.: 0.3% Curb and Gutter				

*Controlling design criteria (see [Section 9.2](#)).

- (1) Stopping Sight Distance. Table values are for passenger cars on level grade.
- (2) Decision Sight Distance. Table values are for a stop on an urban road, Avoidance Maneuver B, as described in [Figure 10.3A](#).
- (3) Intersection Sight Distance. Table values are for passenger cars for assumed conditions described in [Figure 10.4C](#).
- (4) Superelevation Rate. See [Section 11.3](#) for superelevation rates based on e_{\max} , design speed and radii of horizontal curves. The 6 percent superelevation rate should only be used on suburban collectors.
- (5) Horizontal Sight Distance. Table provides the necessary middle ordinate, assuming the maximum radii and stopping sight distance.
- (6) Vertical Curvature (K-values). K-values are based on level stopping sight distances.
- (7) Maximum Grades. Short lengths of grades (e.g., less than 500 feet), one-way downgrades and low-volume collectors may be up to 2 percent steeper.

ALIGNMENT CRITERIA FOR SUBURBAN/URBAN COLLECTORS

Figure 21.3D

21.4 REFERENCES

1. *A Policy on Geometric Design of Highways and Streets*, AASHTO, 2001.
2. *Highway Safety Design and Operations Guide*, AASHTO, 1997.
3. *Highway Capacity Manual 2000*, TRB, 2000.
4. NCHRP 395 *Capacity and Operational Effects of Midblock Left-Turn Lane*, TRB, 1997.
5. *Traffic Engineering Handbook*, ITE, 1999.
6. *Roadside Design Guide*, AASHTO, 2002.
7. *Guide for Development of Bicycle Facilities*, AASHTO, 1999.

Table of Contents

<u>Section</u>	<u>Page</u>
22.1 GENERAL	22.1(1)
22.1.1 Descriptions	22.1(1)
22.1.2 Secondary and State "C" Construction Projects.....	22.1(2)
22.1.3 Jurisdictional Systems.....	22.1(2)
22.1.3.1 State Highway System	22.1(2)
22.1.3.2 County System.....	22.1(3)
22.1.3.3 Municipal System	22.1(3)
22.1.3.4 Jurisdictional Transfers	22.1(3)
22.1.4 Adding Routes to State Highway System.....	22.1(4)
22.1.4.1 Subdivision Roads and Streets	22.1(4)
22.1.4.2 Non-Subdivision Roads.....	22.1(4)
22.1.4.3 Maintenance for Paved Roads under the Belt Line Act..	22.1(5)
22.2 DESIGN ELEMENTS	22.2(1)
22.2.1 Traffic Volume	22.2(1)
22.2.2 Design Speed.....	22.2(1)
22.2.3 Sight Distances	22.2(1)
22.2.4 Horizontal Alignment	22.2(1)
22.2.5 Roadside Safety.....	22.2(2)
22.2.6 Bridges	22.2(2)
22.2.7 Typical Sections	22.2(2)
22.3 TABLES OF DESIGN CRITERIA	22.3(1)
22.4 REFERENCES.....	22.4(1)

Chapter Twenty-two

LOCAL ROADS AND STREETS

Local roads and streets primarily serve as access roads to farms, residences, businesses or other abutting properties. They distribute traffic to highways in the higher functional classification network. Local roads and streets are often designed to the minimum criteria and without the same degree of engineering detail and analysis afforded the higher classification highways.

This Chapter discusses the minimum criteria used in the design of local roads and streets. Information that is also applicable to the design of rural and urban local roads and streets is included in the following chapters:

- [Chapter 2](#) discusses Participation Agreements between the Department and local officials.
- [Chapter 7](#) discusses local funding programs including State programs for local facilities.
- [Chapters 9, 10, 11, 12 and 13](#) provide guidance on the geometric design elements.
- [Chapter 14](#) provides guidelines on roadside safety issues.
- [Chapter 15](#) provides information on the design of intersections, including intersection alignment, left- and right-turn lanes and channelization.

22.1 GENERAL

22.1.1 Descriptions

1. Rural. A major part of the rural highway system consists of two-lane local roads. These roadways should be designed to accommodate the highest practical criteria compatible with traffic and topography.
2. Urban. A local urban street is a public roadway for vehicular travel including public transit and refers to and includes the entire area within the right of way. The street also serves pedestrian and bicycle traffic and usually accommodates public utility facilities within the right of way. The development or improvement of these streets should be based on a functional street classification that is part of a comprehensive community development plan. The design criteria should be appropriate for the planned development. The two major design controls are (1) the type and extent of urban development with its limitations on rights of way,

and (2) zoning or regulatory restrictions. Local streets primarily serve to provide access to adjacent residential development areas. The overriding consideration is to foster a safe and pleasant environment whereas the convenience of the motorist is secondary. Other local streets not only provide access to adjacent development but also serve limited through traffic. Traffic service features may be an important concern on these streets (e.g., traffic signals, left-turn lanes).

22.1.2 Secondary and State “C” Construction Projects

State roads and streets constructed under the Secondary and State’s “C” Programs are divided into four separate groups:

- Group 1 – roads and streets in subdivisions or residential areas;
- Group 2 – roads and streets that are ½ mile or less in length, are not major connecting road/streets (e.g., to major traffic generator), are not dead-end roads/streets, and have ADT’s less than 250;
- Group 3 – roads and streets that are between ½ and 1 mile in length, are not a connecting road/street and have ADT’s of 500 or less; and
- Group 4 – all other Secondary or “C” roads, except subdivision streets.

The geometric design criteria presented in [Figure 22.3A](#) for Groups 1 through 4 is the minimum criteria for State secondary roads and “C” projects.

22.1.3 Jurisdictional Systems

Local roads and streets may be part of the State Highway System, county road system or a municipal system. These systems are described in [Section 7.3](#). The following sections will apply to local roads and streets.

22.1.3.1 State Highway System

The State Highway System consists of all highways under the jurisdiction of the South Carolina Department of Transportation. Any State facility functionally classified as a local road or street must meet the criteria in this Chapter.

The Department may, in its discretion, add additional highways to the State Highway System by constructing new highways or taking over highways from the county or the municipal street systems. These additions must meet the criteria for transfer in [Section 22.1.4](#). Also, the Department cannot exceed any existing county mileage cap for State highways. This mileage cap varies per county.

The Department and any municipality may agree to construct any street in the State Highway System as a different type beyond that required by the Department, provided the municipality pays for the extra construction cost.

22.1.3.2 County System

The county governments are responsible for all rural roads within their boundaries that are not on the State or Municipal Highway Systems. Corporate limit changes due to annexation or disconnection of territory by municipalities do not automatically change the termini of county highways or extensions to county highways. County highways that may be included by annexation or extensions that are excluded by disconnection retain their existing status until formal action to change the status is taken by the county board.

22.1.3.3 Municipal System

A municipality includes a city or incorporated town. Corporate authorities mean (1) the city council or similar body when the reference is to cities, (2) the council when the reference is to municipalities under the commission form of government, and (3) the board of trustees or similar body when the reference is to incorporated towns.

The municipal street system includes existing streets and streets established in municipalities that are not a part of the State Highway System or County Highway System, together with roads outside their corporate limits over which they have jurisdiction.

Streets outside of municipal corporate limits, which are continuations of municipal streets, leading to, and within a reasonable distance of, definite objectives (e.g., a State highway, cemetery, school) may be constructed and maintained by the municipality.

State or county highways that are included within the corporate limits of a municipality by reason of annexation remain under the jurisdiction of the State or county until a formal agreement is executed transferring jurisdiction to the municipality.

22.1.3.4 Jurisdictional Transfers

When a local agency has the jurisdiction of a street or highway, it has various responsibilities (e.g., reconstruction, signing, maintenance). All of these responsibilities remain with the local agency until the jurisdiction is transferred to another entity.

The transfer of jurisdiction for any highway from one highway system to another must be accomplished by agreement between the two involved highway authorities.

22.1.4 Adding Routes to State Highway System

The following criteria apply to rural and urban local roads and streets that will be added to the State Highway System for construction and maintenance.

22.1.4.1 Subdivision Roads and Streets

1. These roads and streets must be publicly maintained. Publicly maintained means that the road or street is maintained by the county, municipality or other political entity having jurisdiction.
2. All roads and streets should be adequately drained.
3. In order for a road or street in any subdivision to be accepted into the System, a minimum of 20 percent of the lots on the road or street must have a house constructed on them.
4. Each road or street must have a minimum right of way width of 50 feet unless extenuating circumstances dictate otherwise.
5. Each road or street must be contiguous to the State Highway System.
6. The road or street must not possess any unusual features that will cause the construction cost to be abnormally high.
7. The road or street cannot cross a dam that has been constructed for the purpose of impounding surface waters.
8. The road or street cannot be located where a narrow buffer strip is maintained between the right of way of the road or street and adjacent property in a manner that restricts access to other adjacent landowners.
9. Plats of subdivisions in which roads or streets are located which are requested to be accepted into the System will be made available to the Department.

22.1.4.2 Non-Subdivision Roads

1. Non-subdivision roads or streets must be publicly maintained. Publicly maintained means that the road or street is maintained by the county, municipality or other political entity having jurisdiction.
2. Each road or street must be contiguous to the State Highway System.
3. The road or street must not possess any unusual features that will cause the construction cost to be abnormally high.

4. No road or street will serve essentially as a drive to private residences, private businesses, or private recreational areas. All roads or streets will serve public interest.
5. The road or street cannot cross a dam that has been constructed for the purpose of impounding surface water.
6. All roads and streets should be adequately drained.
7. Each road or street must have a minimum right of way width of 50 feet unless extenuating circumstances dictate otherwise.

22.1.4.3 Maintenance for Paved Roads under the *Belt Line Act*

1. The riding surface should have reasonably good riding qualities and be in good condition.
2. The traveled way width and shoulder widths should be adequate to provide for the safe movement of the anticipated traffic volumes.
3. The geometry (vertical and horizontal alignment) must meet minimum safety requirements.
4. The overall roadbed should be structurally adequate to carry the anticipated loads.
5. The roadway drainage should be adequate with sufficient outfall drainage.
6. Where adjacent property has been subdivided for development purposes, a minimum of 20 percent of the lots must have a house constructed on them.
7. The road or street cannot cross a dam that has been constructed for the purpose of impounding surface waters.
8. If the above conditions are not met and the road or street is entered into the State system, it must be done so with the understanding that "C" funds will be used for its improvement.

All roads or streets that are programmed for construction, whether they are in a subdivision or not, must have a sufficient traffic volume as determined by the Department to justify the improvement.

Each of the roads requested for improvement under the *Belt Line Act* must be inspected to insure the criteria outlined above is met. It is the District Engineering Administrator's responsibility to have the road evaluated and forward a recommendation to the State Highway Engineer.

22.2 DESIGN ELEMENTS

The design criteria discussed in this Section applies to all local roads and streets included in the State Highway System. For roads and streets maintained by local governments, additional guidance can be found in the AASHTO publications, *A Policy on Geometric Design of Highways and Streets* and the *Guidelines for Geometric Design of Very Low-Volume Local Roads (ADT ≤ 400)*.

22.2.1 Traffic Volume

Traffic volume is not usually a major factor in determining the geometric design criteria to be used in designing residential streets. Traditionally, these streets are designed with a standard two-lane cross section, but a four-lane cross section may be appropriate in certain urban areas, as governed by traffic volume, administrative policy or other community considerations. However, to provide the requisite traffic mobility and safety together with the essential economy in construction, maintenance and operation, they must be planned, located and designed to be suitable for predictable traffic operations and must be consistent with the development and culture abutting the right of way.

For streets serving industrial or commercial areas, traffic volume may be a major factor. For these streets, the ADT projected to 20 years is desirable.

22.2.2 Design Speed

Design speed is a selected speed used to determine the various design features of the roadway. Geometric design features should be consistent with a specific design speed selected as appropriate for environmental and terrain conditions. Typically, design speeds are between 20 and 55 miles per hour for local roads and streets. See [Section 22.3](#) for additional guidance on the selection of design speed.

22.2.3 Sight Distances

The minimum stopping, passing and intersection sight distances should be included when designing for local roads and streets, wherever possible. [Chapter 10](#) provides a detailed discussion on sight distance criteria and [Section 22.3](#) provides specific sight distance values for local roads and streets.

22.2.4 Horizontal Alignment

Local roads and streets with lower speeds can support adjustments in superelevation rates to better fit the terrain of adjoining properties. See [Section 11.3](#) for a discussion on superelevation rates for low-speed urban streets.

22.2.5 Roadside Safety

The Department requires that the roadside be cleared, except for designated trees. These trees should be identified at the Design Field Review and noted on the Plans.

22.2.6 Bridges

The minimum clear roadway width (traveled way plus shoulders) for new and reconstructed bridges should equal the approach roadway width and have a design loading structural capacity of HL-93.

[Figure 22.2A](#) provides the design criteria for existing bridges on local roads and streets.

22.2.7 Typical Sections

[Figures 22.2B through 22.2D](#) present sample cross sections for both rural and urban local roads and streets. The use of curb and gutter and valley gutter sections are common on urban streets to reduce right of way requirements. A large majority of urban residential streets provide two travel lanes with or without parking lanes on one or both sides. The large majority of roads and streets developed under the “C” Program do not have provisions for parking.

For specific design criteria, see the tables of design criteria (see [Figure 22.3A](#)).

Design Volume (veh/day)	Minimum Clear Roadway Width ^{(1), (2), (3)}	Design Loading Structural Capacity
0 to 50	20 ft	H 10
50 to 250	20 ft	H 15
250 to 1500	22 ft	H 15
1500 to 2000	24 ft	H 15
> 2000	28 ft	H 15

Notes:

1. Clear width between curbs or rails, whichever is the lesser.
2. Minimum clear widths that are 2 feet narrower may be used on roads with few trucks. In no case should the minimum clear width be less than the approach traveled way width.
3. For single-lane bridges, use 18 feet.

**MINIMUM CLEAR ROADWAY WIDTHS AND DESIGN LOADINGS FOR
BRIDGES TO REMAIN IN PLACE**

Figure 22.2A

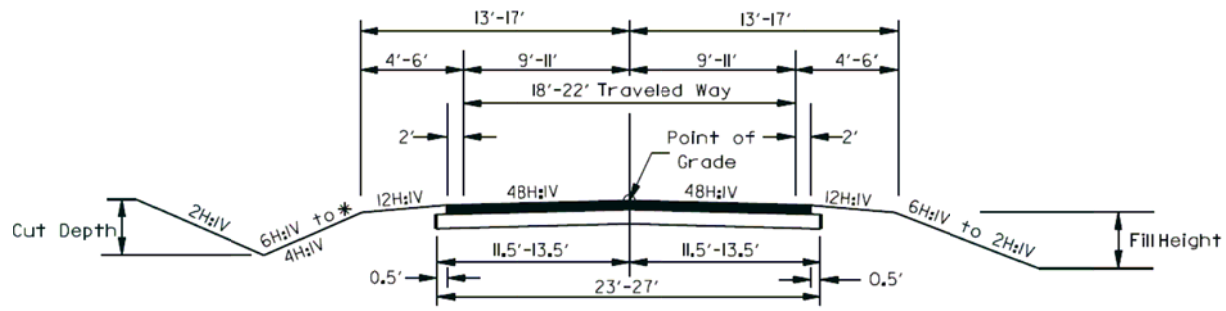

* THIS SLOPE MAY BE VARIED WHEN A DEEPER DITCH IS NECESSARY FOR DRAINAGE PURPOSES, USING A MINIMUM SLOPE OF 12H:V AND A MAXIMUM SLOPE OF 4H:V. WHERE A DEEPER DITCH THAN PROVIDED BY A 4H:V IS NECESSARY, THE DITCH SHALL BE PLACED FARTHER FROM THE CL CONTINUING THE 4H:V SLOPE TO PROVIDE FOR THE NECESSARY DEPTH. SEE PROFILE FOR THE SPECIAL DITCH GRADES.

Note: See [Figure 22.3A](#) for specific road group criteria.

**TYPICAL LOCAL ROAD OR STREET
(With Shoulders)
Figure 22.2B**

Revised: 10-2005

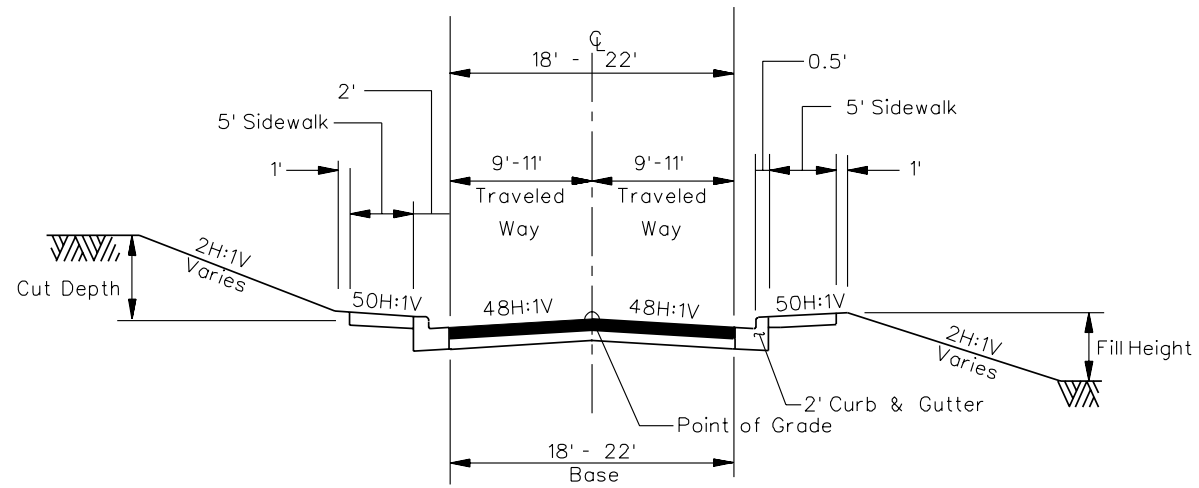

Note: See [Figure 22.3A](#) for specific road group criteria.

**TYPICAL URBAN LOCAL STREET
(With Curb and Gutter)**

Figure 22.2C

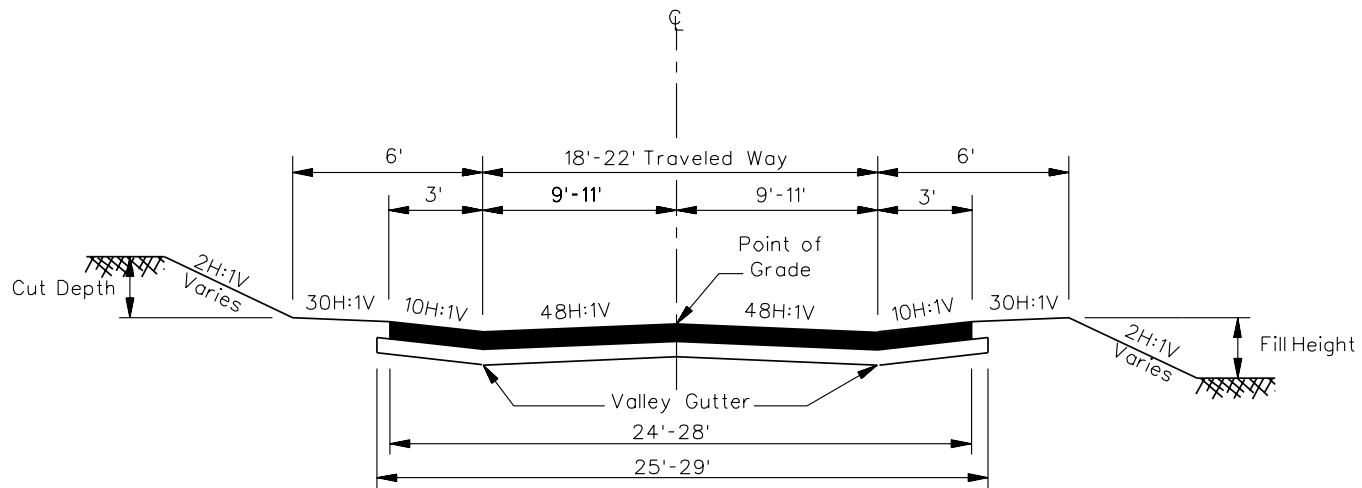

Note: See [Figure 22.3A](#) for specific road group criteria.

**TYPICAL URBAN LOCAL STREET
(With Valley Gutter)**

Figure 22.2D

22.3 TABLES OF DESIGN CRITERIA

Figures 22.3A through 22.3C present the Department's design and alignment criteria for rural and urban local roads and streets. The designer should consider the following when using these figures:

1. Functional Classification. To determine the latest functional classification of a facility, the designer should contact Road Data Services.
2. Applicability. Note that some of the cross-section elements included in the figures (e.g., TWLTL) are not automatically warranted in the project design. The values in the figures only apply after the decision has been made to include the design element in the highway cross section.
3. Manual Section References. These figures are intended to provide a concise listing of design values for easy use. However, the designer should review the *Manual* section references for more information on the design elements.
4. Footnotes. The figures include many footnotes, which are identified by a number in parentheses (e.g., (3)). The information in the footnotes is critical to the proper use of the design tables.
5. Controlling Design Criteria. The figures provide an asterisk to indicate controlling design criteria. If the values in the tables cannot be met, the designer should contact the Program Manager for alternatives. [Section 9.2](#) discusses this in more detail and presents the process for approving design exceptions to controlling criteria.
6. Group Designations. [Figure 22.3A](#) has been segregated according to the Group designations defined in [Section 22.1.2](#).

Design Element			Manual Section	Design Criteria				
				Group 1	Group 2	Group 3	Group 4	
Design Controls	Design Forecast Year (1)		9.6.2	20 years	20 years	20 years	20 years	
	*Design Speed		9.5.2	(2a)	20 – 50 mph	30 – 50 mph	35 - 60 mph	
	Access Control		9.8	Controlled by Regulation	Controlled by Regulation	Controlled by Regulation	Controlled by Regulation	
	Level of Service		9.6.4	N/A	N/A	N/A	N/A	
Cross Section Elements	*Travel Lane Width		13.2.3	Min: 9'	Des.: 10' Min.: 9'	Des.: 11' Min.: 10'	11'	
	*Shoulder Width (3)		13.2.4	4' or C/G	Des.: 6' Min.: 4' or C/G	Des.: 6' Min.: 4' or C/G	6' or C/G	
	Auxiliary Lanes	Lane Width	13.2.5	N/A	N/A	N/A	Min. 11' (4)	
		Shoulder Width		N/A	N/A	N/A	6' or C/G	
	Cross Slope	*Travel Lane	13.2.3.3	2.08%	2.08%	2.08%	2.08%	
		Auxiliary Lane	13.2.5	N/A	N/A	N/A	2.08%	
		*Shoulder	13.2.4.3	8.33%	8.33%	8.33%	8.33%	
	Bicycle	Lane Width (5)	13.2.3	4'	4'	4'	4'	
		Shared Roadway Width		N/A	N/A	N/A	14' Outside Travel Lane	
	Curb & Gutter (Urban)	Type	21.2.9	Vertical or Sloping				
		Width		2'				
	Sidewalk Width		21.2.10	5'	5'	5'	5'	
Median Width	TWLTL	21.2.6	N/A	N/A	N/A	15'		
Roadway Elements	Side Slopes	Cut Section	Foreslope	13.3.1	6H:1V to 4H:1V	6H:1V to 4H:1V	6H:1V to 4H:1V	6H:1V to 4H:1V
			Ditch Type		V Ditch	V Ditch	V Ditch	V Ditch
			Back Slope		2H:1V	2H:1V	2H:1V	2H:1V
	Fill Section	6H:1V to 2H:1V	6H:1V to 2H:1V		6H:1V to 2H:1V	6H:1V to 2H:1V		
Median Slopes	TWLTL	21.2.7	N/A	N/A	N/A	2.08%		
Clear Zone		14.3	(6a)	(6a)	(6a)	(6b)		

*Controlling design criteria (see Section 9.2)

**GEOMETRIC DESIGN CRITERIA FOR SECONDARY AND STATE "C" ROADS
(New Construction/Reconstruction)**

Figure 22.3A

Revised: 10-2005

Design Element			Manual Section	Design Criteria			
				Group 1	Group 2	Group 3	Group 4
Bridges	New and Reconstructed Bridges	*Structural Capacity		HL-93			
		*Clear Roadway Width	13.5.1.1	(7)	(7)	(7)	(7)
	Existing Bridges to Remain in Place	*Structural Capacity		H-10 to H-15	H-10 to H-15	H-10 to H-15	H-10 to H-15
		*Clear Roadway Width	13.5.1.1	(8)	(8)	(8)	(8)
	*Vertical Clearance (Local Roads Under) (9a)	New/Replaced Overpassing Bridges (9b)	12.6	16' - 0"	16' - 0"	16' - 0"	16' - 0"
		Existing Overpassing Bridges		14' - 0"	14' - 0"	14' - 0"	14' - 0"
		Pedestrian Bridges		17' - 0"	17' - 0"	17' - 0"	17' - 0"
		Overhead Signs		17' - 6"	17' - 6"	17' - 6"	17' - 6"
	Clearance (Local Roads Over)	*Railroads	12.6	23' - 0"	23' - 0"	23' - 0"	23' - 0"
		Underpass Width	13.5.2	Approach Roadway Width Including Sidewalks, Where Applicable.			Traveled Way Plus Clear Zone

*Controlling design criteria (see Section 9.2)

**GEOMETRIC DESIGN CRITERIA FOR SECONDARY AND STATE "C" ROADS
(New Construction/Reconstruction)**

(Continued)

Figure 22.3A

GEOMETRIC DESIGN CRITERIA FOR SECONDARY AND STATE “C” ROADS (New Construction/Reconstruction)

Footnotes to [Figure 22.3A](#)

- (1) Design Forecast Year. Table values are desirable. For rural roads, the design year may be current traffic volumes. For urban streets, the minimum design year is 10 years.
- (2) Design Speed.
 - a. Design speed is not a major factor for Group 1 roads and streets. Select a design speed based on available right of way, terrain, likely pedestrian presence, adjacent development and other area controls.
 - b. Group 4 roads may be designed for 45 miles per hour on selected rural routes and “C” projects, if agreed upon during the Design Field Review.
- (3) Shoulder Width. Shoulders should be increased by 3.5 feet where guardrail is used.
- (4) Auxiliary Lane Width. The auxiliary lane width should be the same as the adjacent travel lane.
- (5) Bicycle Facilities Lane Width. If curb and gutter is provided, provide a 5-foot width from the face of curb. For design speeds greater than 45 miles per hour, the bike lane width should be increased in accordance with *AASHTO Guide for the Development of Bicycle Facilities*.
- (6) Clear Zone.
 - a. Desirably provide a 7 to 10 foot clear area from the edge of traveled way for rural roads. Curbs do not have a significant redirection capability. Obstructions behind a curb should be located at or beyond the minimum clear zone distances. Where minimum recommended clear zones cannot be provided, locate fixed objects as far from traveled way as practical, desirable 5.5 feet but in no case closer than 1.5 feet from the face of curb.
 - b. The clear zone will vary according to design speed, traffic volumes, side slopes and horizontal curvature. In addition, guardrail will be installed at bridge ends and along fill slopes steeper than 4H:1V exceeding 10 feet in height.
- (7) New and Reconstructed Bridge Widths. See [Section 22.2.6](#)
- (8) Existing Bridge Widths to Remain in Place. See [Section 22.2.6](#)
- (9) Vertical Clearance (Local Roads Under).
 - a. The clearance must be available over the traveled way, shoulders, and any anticipated future widening.
 - b. Table value includes allowance for future overlays.

Design Element		Manual Section	Design Speed							
			20 mph	25 mph	30 mph	35 mph	40 mph	45 mph	50 mph	55 mph
*Stopping Sight Distance (1)		10.1	115'	155'	200'	250'	305'	360'	425'	495'
Passing Sight Distance		10.2	710'	900'	1090'	1280'	1470'	1625'	1835'	1985'
Intersection Sight Distance (2)		10.4	225'	280'	335'	390'	445'	500'	555'	610'
*Minimum Radii	e _{max} = 8%	11.2.3	-	-	-	-	-	-	-	965'
	e _{max} = 6%		115'	185'	275'	380'	510'	660'	835'	-
*Superelevation Rate (3)		11.3	6%	6%	6%	6%	6%	6%	6%	8%
*Horizontal Sight Distance (4)		11.4	14.5'	16.0'	18.0'	20.5'	23.0'	24.5'	30.0'	32.0'
*Minimum Vertical Curvature (K-values) (5)	Crest	12.5	7	12	19	29	44	61	84	114
	Sag		17	26	37	49	64	79	96	115
*Maximum Grade	Level	12.3.1	8%	7%	7%	7%	7%	6%	6%	6%
	Rolling		11%	11%	10%	10%	9%	8%	7%	7%
	Mountainous		16%	15%	14%	13%	12%	10%	10%	10%
Minimum Grade (6)		12.3.2	Des.: 0.5%				Min.: 0.0%			

*Controlling design criteria (see Section 9.2).

- (1) Stopping Sight Distance. Table values are for passenger cars on level grade.
- (2) Intersection Sight Distance. Table values are for passenger cars for assumed conditions described in Figure 10.4C.
- (3) Superelevation Rate. See Section 11.3 for superelevation rates based on e_{max}, design speed and radii of horizontal curves.
- (4) Horizontal Sight Distance. The table provides the necessary middle ordinate, assuming the maximum radii and stopping sight distance.
- (5) Vertical Curvature (K-values). K-values are based on level stopping sight distances.
- (6) Minimum Grade. The minimum grade of 0 percent can only be used on ditch sections where there is an adequate roadway cross slope and ditch grade. The minimum for curb and gutter is 0.3 percent and for valley gutter it is 0.4 percent.

ALIGNMENT CRITERIA FOR RURAL LOCAL ROADS AND STREETS

Figure 22.3B

Design Element	Manual Section	Design Speed								
		20 mph	25 mph	30 mph	35 mph	40 mph	45 mph	50 mph	55 mph	
*Stopping Sight Distance (1)	10.1	115'	155'	200'	250'	305'	360'	425'	495'	
Intersection Sight Distance (2)	10.4	225'	280'	335'	390'	445'	500'	555'	610'	
*Minimum Radii	11.2.3	$e_{max} = 8\%$	-	-	-	-	-	-	-	965'
		$e_{max} = 6\%$	-	-	-	-	-	-	835'	-
		$e_{max} = 4\%$	125'	205'	300'	420'	565'	730'	-	-
*Superelevation Rate (3)	11.3	4%	4%	4%	4%	4%	4%	6%	8%	
*Horizontal Sight Distance (4)	11.5	13.0'	15.0'	16.5'	18.5'	20.5'	22.5'	30.0'	32.0'	
*Minimum Vertical Curvature (K-values) (5)	12.5	Crest	7	12	19	29	44	61	84	114
		Sag	17	26	37	49	64	79	96	115
*Maximum Grade (6)	12.3	Level	8%	7%	7%	7%	7%	6%	6%	6%
		Rolling	11%	11%	10%	10%	9%	8%	7%	7%
		Mountainous	15%	15%	14%	13%	12%	10%	10%	10%
Minimum Grade	12.3	Des.: 0.5% Min.: 0.3%								

*Controlling design criteria (see [Section 9.2](#)).

- (1) Stopping Sight Distance. Table values are for passenger cars on level grade.
- (2) Intersection Sight Distance. Table values are for passenger cars for assumed conditions described in [Figure 10.4C](#).
- (3) Superelevation Rate. See [Section 11.3](#) for superelevation rates based on e_{max} , design speed and radii of horizontal curves.
- (4) Horizontal Sight Distance. The table provides the necessary middle ordinate, assuming the maximum radii and stopping sight distance.
- (5) Vertical Curvature (K-values). K-values are based on level stopping sight distances.
- (6) Maximum Grades. For urban streets in commercial and industrial areas, grades should be limited to 8% or less.

ALIGNMENT CRITERIA FOR URBAN LOCAL ROADS AND STREETS

Figure 22.3C

22.4 REFERENCES

1. *A Policy on Geometric Design of Highways and Streets*, AASHTO, 2001.
2. *Highway Safety Design and Operations Guide*, AASHTO, 1997.
3. *Roadside Design Guide*, AASHTO, 2002.
4. *Highway Capacity Manual 2000*, TRB, 2000.
5. *Guidelines for Geometric Design of Very Low-Volume Local Roads (ADT \leq 400)*, AASHTO, 2001.
6. *Guide for the Development of Bicycle Facilities*, AASHTO, 1999.

Table of Contents

<u>Section</u>	<u>Page</u>
23.1 INTRODUCTION	23.1(1)
23.2 BACKGROUND	23.2(1)
23.2.1 Federal 3R Regulations	23.2(1)
23.2.2 Special Report 214	23.2(1)
23.2.3 FHWA Technical Advisory T5040.28	23.2(2)
23.3 3R PROCEDURES	23.3(1)
23.3.1 Objectives	23.3(1)
23.3.2 3R Project Evaluation	23.3(2)
23.4 3R GEOMETRIC DESIGN CRITERIA	23.4(1)
23.4.1 Design Speed	23.4(1)
23.4.2 Highway Capacity	23.4(1)
23.4.3 Roadway Widths	23.4(1)
23.4.4 Bridges	23.4(1)
23.4.5 Right of Way	23.4(2)
23.4.6 Horizontal and Vertical Alignment	23.4(2)
23.4.7 Intersections At-Grade	23.4(3)
23.4.8 Special Design Elements	23.4(3)
23.4.9 Roadside Safety	23.4(3)
23.4.9.1 Clear Zones	23.4(3)
23.4.9.2 Roadside Ditches	23.4(4)
23.4.9.3 Safety Appurtenances	23.4(4)
23.5 REFERENCES	23.5(1)

Chapter Twenty-three

GEOMETRIC DESIGN OF 3R PROJECTS

(Non-Freeways)

23.1 INTRODUCTION

A significant percentage of the Department's current and future highway program will involve work on existing highways. The Department's responsibility is to realize the greatest overall benefit from the available funds. Therefore, the geometric design of projects on existing highways must be viewed from a different perspective than the design of new construction/reconstruction projects. 3R (resurfacing, restoration and rehabilitation) projects are often initiated for reasons other than geometric design deficiencies (e.g., pavement deterioration), and they must often be designed within restrictive right of way, financial and environmental constraints. Therefore, the design criteria for new construction are often not attainable without major and, frequently, unacceptable adverse impacts. At the same time, however, the Department must take the opportunity to make cost-effective, practical improvements to the geometric design of existing highways and streets.

For these reasons, the Department has adopted a policy statement and procedures for the geometric design of 3R non-freeway projects. These procedures will often result in a geometric design of a 3R non-freeway project that is lower than that for new construction/reconstruction. These procedures are intended to find the balance among many competing and conflicting objectives. These include the objectives of improving South Carolina's existing highways; minimizing the adverse impacts of highway construction on existing highways; and improving the greatest number of miles with the available funds.

23.2 BACKGROUND

23.2.1 Federal 3R Regulations

On June 10, 1982, FHWA issued its Final Rule entitled *Design Standards for Highways; Resurfacing, Restoration and Rehabilitation of Streets and Highways Other Than Freeways*. This rule modified 23 CFR Part 625 to adopt a flexible approach to the geometric design of 3R projects. Part 625 was modified again on March 31, 1983 to explicitly state that one objective of 3R projects is to enhance highway safety. In the 1982 rule, FHWA determined that it is not practical to adopt 3R design criteria for nationwide application. Instead, each State can develop its own criteria and/or procedures for the design of 3R projects, subject to FHWA approval. This allows each State to tailor its design procedures for the 3R program according to the prevailing conditions within that State. This approach is in contrast to the application of criteria for new construction and reconstruction, for which the *AASHTO A Policy on Geometric Design of Highways and Streets* provides nationwide criteria for application.

23.2.2 Special Report 214

In 1987, the Transportation Research Board published Special Report 214 *Designing Safer Roads; Practices for Resurfacing, Restoration and Rehabilitation*. This study was mandated by the *Surface Transportation Assistance Act* of 1982. The objective of the TRB study was to examine the safety cost-effectiveness of highway geometric design criteria and to recommend minimum design criteria for 3R projects on non-freeways. The final TRB report (SR214):

1. reviewed the existing 3R design practices of 15 State highway agencies and several local highway agencies;
2. examined the relationship between highway crash potential and geometric design elements, based on the existing research literature and on special research projects commissioned as part of the TRB study;
3. examined the relationship between the extent of geometric design improvements and the cost of 3R projects;
4. discussed the issue of cost-effectiveness relative to geometric design improvements on 3R projects;
5. reviewed the literature on tort liability and geometric design;
6. presented a safety-conscious design process; and
7. presented specific numerical criteria for the geometric design of 3R projects for the following elements:

- travel lane and shoulder widths,
- horizontal curvature and superelevation,
- crest vertical curves,
- bridge widths,
- side slopes, and
- pavement cross slopes.

The SR214 information may be considered where appropriate by the designer for use in South Carolina.

23.2.3 FHWA Technical Advisory T5040.28

Pursuant to its adoption of SR214, FHWA issued on October 17, 1988, Technical Advisory T5040.28 “Developing Geometric Design Criteria and Processes for Non-Freeway RRR Projects.” The purpose of the Advisory is to provide guidance on developing procedures and/or criteria for the design of Federal-aid, non-freeway 3R projects. The Advisory:

- discusses the approach to developing 3R procedures or criteria;
- discusses the factors which should be evaluated in a safety-conscious design process;
- discusses the application of design exceptions for the FHWA controlling design criteria on 3R projects; and
- presents specific criteria for the design of 3R projects based on SR214.

The information from the Technical Advisory may be considered where appropriate for use in South Carolina.

23.3 3R PROCEDURES

23.3.1 Objectives

From an overall perspective, the 3R program is intended to improve the greatest number of highway miles within the available funds for highway projects. "Improve" is meant to apply to all aspects which determine a facility's serviceability, including:

- the structural integrity of the pavement, bridges and culverts;
- the drainage design of the facility to, among other objectives, minimize ponding on the highway, to protect the pavement structure from failure, and to prevent roadway flooding during the design-year storm;
- from a highway capacity perspective, the level of service provided for the traffic flow;
- the adequacy of access to abutting properties;
- the geometric design of the highway to safely accommodate expected vehicular speeds and traffic volumes;
- the roadside safety design to reduce, within some reasonable boundary, the adverse impacts of run-off-the-road vehicles; and
- the traffic control devices to provide the driver with critical information and to meet driver expectancies.

These objectives are competing for the limited funds available for 3R projects on existing highways. The Department's responsibility is to realize the greatest overall benefit from the available funds. Therefore, on individual projects, some compromises may be necessary to achieve the goals of the overall highway program. Specifically for geometric design and roadside safety, the compromise is between what is desirable (new construction/reconstruction criteria) and what is practical for the specific conditions of each highway project.

Considering the above discussion, the Department has adopted a policy statement and procedures for the geometric design of 3R non-freeway projects. The overall objective of the Department's criteria is to fulfill the requirements of the FHWA regulation and Technical Advisory which govern the 3R program. These objectives may be summarized as follows:

1. 3R projects are intended to extend the service life of the existing facility and to return its features to a condition of structural or functional adequacy.

2. 3R projects are intended to enhance highway safety.
3. 3R projects are intended to incorporate cost-effective, practical improvements into the geometric design of the existing facility.

23.3.2 3R Project Evaluation

The designer should evaluate available data when determining the geometric design of 3R non-freeway projects. The necessary evaluations presented for 3R projects are based on the FHWA Technical Advisory T5040.28 "Developing Geometric Design Criteria and Processes for Non-freeway RRR Projects." These are:

1. Conduct Field Review. The designer should typically schedule a thorough field review of the proposed 3R project. One objective of the field review will be to identify potential safety hazards and potential safety improvements to the facility.
2. Document Existing Geometrics. The designer should typically review the as-built plans and combine this with the field review to determine the existing geometrics within the project limits. This review includes lane and shoulder widths, horizontal and vertical alignment, intersection geometrics and the roadside safety design.
3. Crash Experience. The crash data within the limits of the 3R project should be evaluated. Crash data is available from the Traffic Engineering Division. The following crash data analyses should be conducted:
 - a. Crash Rate versus Statewide Average (for that type facility). This may provide an overall indication of safety problems within the 3R project limits.
 - b. Crash Analysis by Type. This may indicate if certain types of crashes are a particular problem. For example, a disproportionate number of head-on and/or sideswipe crashes may indicate inadequate roadway width. A disproportionate number of fixed-object crashes may indicate an inadequate roadside clear zone.
 - c. Crash Analysis by Location. Crashes may cluster about certain locations, such as a horizontal curve or intersection. In particular, the analysis should check to see if any sites on the Department's list of high-crash locations, as identified by the Department's crash data system, fall within the proposed project limits.
4. Speed Studies. It may be appropriate to review existing speed studies in the vicinity of the project and, if necessary, conduct a speed study to assist in determining the design speed of the 3R project. In addition, it may be desirable to conduct spot speed studies at specific locations (e.g., in advance of a

horizontal or vertical curve) to assist in the determination of geometric design improvements.

5. Traffic Volumes. The designer should examine the current and predicted traffic volumes within the limits of the 3R project. This may influence the decisions on the extent of geometric improvement.
6. Early Coordination for Right of Way Acquisition. Significant right of way acquisitions are typically outside the scope of 3R projects. However, if additional right of way is required for selective safety improvements, the designer should, as early as feasible, determine which improvements will be incorporated into the project design and initiate the right of way acquisition process.
7. Pavement Condition. 3R projects are often programmed because of a significant deterioration of the pavement structure. The extent of pavement improvement will influence the decision on the practicality of improving the existing geometrics. In addition, all 3R projects will include a pavement design that meets the Department's requirements.

Whenever the proposed pavement improvement is major, it may be practical to include geometric improvements (e.g., lane and shoulder widening) in the project design. However, the proper level of geometric improvement is often determined by many factors other than the extent of pavement improvement. These include available right of way, traffic volumes, crash experience and available funds for the project. Therefore, it may be appropriate for the 3R project to include, for example, full-depth pavement reconstruction and minimal geometric improvement, if deemed proper to meet the safety and operational objectives of the 3R program.

8. Geometric Design of Contiguous Highway Sections. The designer should examine the geometric features and operating speeds of highway sections contiguous to the 3R project. This includes investigating whether or not any highway improvements are in the planning stages. The 3R project should provide design continuity with the contiguous sections. This involves a consideration of factors such as driver expectancy, geometric design consistency and proper transitions between sections of different geometric designs.
9. Physical Constraints. The physical constraints within the limits of the 3R project will often determine what geometric improvements are practical and cost effective. These include topography, adjacent development, available right of way, utilities and environmental constraints (e.g., wetlands).
10. Traffic Control Devices. All signing and pavement markings on 3R projects must meet the criteria of the *Manual on Uniform Traffic Control Devices* (MUTCD). The Traffic Engineering Division is responsible for selecting and locating the traffic control devices on the project. The designer will work with the Traffic

Engineering Division to identify possible geometric and safety deficiencies that will remain in place and, therefore, may warrant the use of a traffic control device (e.g., a warning sign). These include narrow bridges and horizontal and vertical curves.

11. Economics. 3R projects are intended to protect the existing economic investment and to derive the maximum economic benefit from the Department's existing highway system. Therefore, economic factors (i.e., the cost of improvement versus the anticipated benefit) are a major consideration in determining which geometric design improvements are practical and reasonable.
12. Potential Impacts of Various Types of Improvements. 3R projects may impact the social, economic and environmental nature of the surrounding land and development. In particular, the existing right of way may severely restrict the practical extent of geometric improvements.

Once the project evaluation is completed, the Project Manager will prepare the Project Planning Report that will recommend the proposed improvements for the 3R project.

23.4 3R GEOMETRIC DESIGN CRITERIA

As documented previously, the Department has adopted procedures that apply to the geometric design of 3R non-freeway projects. The Department has not adopted specific numerical criteria for 3R projects; these will be determined on a case-by-case basis. However, the discussion in this Section provides supplemental information on specific geometric design elements to provide the designer with some context in the 3R project evaluation.

23.4.1 Design Speed

The selected design speed should equal or exceed the anticipated posted or regulatory speed limit of the completed facility.

23.4.2 Highway Capacity

Desirably, all elements of the facility will meet the LOS criteria for a DHV and/or ADT determined for 10 years beyond the expected construction completion date. At a minimum, the highway facility should accommodate the LOS for the current DHV and/or ADT.

23.4.3 Roadway Widths

In general, the roadway width for a 3R project should be selected considering the acceptable width from an operational and safety perspective; considering what is available for a practical improvement based on right of way and environmental impacts; and considering that, in general, it is better to improve more miles to a lower level than to improve fewer miles to a higher level. All of these considerations are consistent with the overall objectives of the Department's 3R program.

23.4.4 Bridges

Several bridges may be within the limits of the 3R project. The scope of work may be any of the following:

1. Bridge Replacement. Depending upon the extent of the structural deficiencies, if any, it may be economical to replace the entire bridge (i.e., superstructure, substructure and foundation).
2. Bridge Reconstruction. If the existing superstructure is structurally deficient but the substructure/foundation is structurally sound, the superstructure may be reconstructed or replaced as part of the 3R project.

3. Bridge Deck Rehabilitation. If the existing bridge deck is structurally deficient, it may be rehabilitated as part of the 3R project. In addition, where the bridge deck is structurally sound but its width is inadequate (i.e., the bridge is functionally deficient), the bridge deck may be rehabilitated solely to widen the bridge deck. Bridge deck widening may then require work to the superstructure and/or substructure.
4. Existing Bridge to Remain In Place. If an existing bridge is structurally sound and if it meets the Department's design loading capacity, it is unlikely to be cost effective to improve the geometrics of the bridge. These are considered existing bridges to remain in place. However, if the geometric deficiencies are severe and/or if there has been an adverse crash experience at the bridge, it may be warranted to rehabilitate the bridge deck to widen the bridge or to make other improvements.

In some cases, only the bridge substructure (e.g., abutments, piers) and/or foundation (e.g., footings, piles) may require rehabilitative work. For the purpose of applying the 3R policy and procedures, these may be considered existing bridges to remain in place.

5. Bridge Rails/Transitions. For reconstructed bridges or rehabilitated bridge decks, the existing bridge rails and approaching guardrail-to-bridge-rail transitions must be upgraded to meet current Department criteria. For existing bridges to remain in place within the limits of a 3R project, the Bridge Design Section will evaluate the adequacy of the existing bridge rail to determine if it should be upgraded. The roadway designer will evaluate the adequacy of the existing approaching guardrail transition for needed upgrading.

The acceptable bridge width will be based on the bridge scope of work. For existing bridges to remain in place, the existing bridge width will be retained. Except for bridge replacements, it is unlikely to be cost effective to improve the existing horizontal or vertical alignment for a bridge within the limits of a 3R project.

23.4.5 Right of Way

The acquisition of significant amounts of right of way is usually outside the scope of a 3R project. Therefore, the existing right of way will typically be unchanged by the 3R project. Where practical, additional right of way should be secured to allow cost-effective geometric and roadside safety improvements.

23.4.6 Horizontal and Vertical Alignment

In the absence of an adverse crash experience, it is unlikely to be cost effective to improve any horizontal or vertical curves within the limits of a 3R project. These are

typically expensive improvements often with major right of way and/or environmental impacts.

23.4.7 Intersections At-Grade

Chapter 15 provides criteria for the detailed design of intersections at-grade. Where practical, improvements to the geometric design of existing intersections within the limits of a 3R project may be appropriate based on Chapter 15 (e.g., adding turn lanes, revising curb radii).

23.4.8 Special Design Elements

Chapter 17 provides the Department's criteria and design details for many special design elements (e.g., ADA). The designer should review this Chapter to determine if these criteria apply to the 3R project.

23.4.9 Roadside Safety

The roadside safety criteria in Chapter 14 have been developed explicitly for new construction and reconstruction. This includes criteria for clear zones and barrier layout details (e.g., length of need). The criteria in Chapter 14 should apply, as practical, to the roadside safety design of 3R projects.

23.4.9.1 Clear Zones

Achieving a roadside clear zone on a 3R project may be impractical. The roadside environment along existing highways is typically cluttered with any number of natural and man-made obstacles. To remove or relocate these obstacles can present formidable problems and public opposition, and it can be very costly. The designer should exercise considerable judgment when determining the appropriate clear zone on the 3R project. The designer should consider the following:

1. Crash Data. The designer should review the crash data to estimate the extent of the roadside safety problem. In particular, there may be sites where clusters of run-off-the-road crashes have occurred.
2. Utilities. Utility poles are a common roadside obstacle on 3R projects. Relocations for safety benefits should be evaluated on a project-by-project basis.
3. Application. The designer may consider a selective application of the roadside clear zone criteria. Along some sections of highway it may be practical to provide

the desirable clear zone while, along other sections, it may be impractical. Judgment will be necessary for the application of the clear zone criteria.

4. Public. Public acceptance of widened clear zones can be a significant issue, especially where the removal of trees is being considered. The designer must judge the community impact and subjectively factor this into the decision-making process.
5. Safety Appurtenances. Installing barriers or impact attenuators is an alternative to providing a wider clear zone. [Section 14.4](#) presents warrants for roadside barriers. On 3R projects, the designer should consider whether a barrier should be installed to shield a hazard within the clear zone. See [Section 23.4.9.3](#) for more discussion.

23.4.9.2 Roadside Ditches

In the absence of an adverse crash history related to roadside ditches parallel to the roadway, all existing roadside ditch configurations may be retained.

23.4.9.3 Safety Appurtenances

During the design of a 3R project, all existing safety appurtenances should be examined to determine if they meet the latest safety performance and design criteria. This includes guardrail, median barriers, impact attenuators, sign supports, luminaire supports, etc. Typically, all safety appurtenances will be upgraded to meet the most recent criteria. This also includes the Department's criteria for the layout of guardrail, median barriers and impact attenuators.

Barrier warrants on 3R projects can be especially difficult to resolve. Basically, the evaluation process should be:

1. Determine if barrier is warranted. See [Section 14.4](#).
2. If an existing run of barrier is located where none is warranted, remove the barrier.
3. If barrier is warranted, consider removing or relocating the hazard; reducing the hazard (e.g., flattening a slope); or making it breakaway.
4. If the hazard cannot be eliminated and a barrier is considered cost effective, then install a barrier. The designer should exercise judgment and apply cost-effective considerations when evaluating existing installations. For existing runs of barrier, insure that they meet the applicable current performance and design criteria, including:

- operational acceptability (hardware, height, etc.);
- dynamic deflection criteria;
- length of need;
- flare rate;
- lateral placement;
- placement on slopes and behind curbs;
- end treatments; and
- transitions.

A common problem on 3R projects will be barrier height because of a pavement overlay or rehabilitation. Each existing barrier run that will remain must be considered individually. As a general rule, the designer should seriously consider raising the barrier where its height after construction will not be within 3 inches of the required height for a new installation.

23.5 REFERENCES

1. *Designing Safer Roads; Practices for Resurfacing, Restoration and Rehabilitation*, Special Report 214, TRB, 1987.
2. *Developing Geometric Design Criteria and Processes for Non-Freeway RRR Projects*, Technical Advisory T5040.28, FHWA, 1988.
3. *A Policy on Geometric Design of Highways and Streets*, AASHTO, 2001.
4. *Roadside Design Guide*, AASHTO, 2002.

Chapter Twenty-four
RESERVED

Chapter Twenty-five
RESERVED

Table of Contents

<u>Section</u>		<u>Page</u>
26.1	SURVEY ELEMENTS	26.1(1)
26.1.1	Survey Schedule.....	26.1(1)
26.1.2	Survey Requirements	26.1(1)
26.1.3	Public Notification	26.1(2)
26.1.4	Survey Requests	26.1(4)
26.1.5	Horizontal and Vertical Control	26.1(5)
26.1.6	Base Plans.....	26.1(10)
	26.1.6.1 Development Methods.....	26.1(10)
	26.1.6.2 Aerial Mapping.....	26.1(11)
26.1.7	Survey Files	26.1(11)
26.2	SURVEY REQUIREMENTS.....	26.2(1)
26.2.1	Utilities	26.2(1)
26.2.2	Existing Roadways	26.2(2)
26.2.3	Railroads.....	26.2(3)
26.2.4	Environmental.....	26.2(3)
26.2.5	Property	26.2(3)
26.3	REFERENCES.....	26.3(1)

Chapter Twenty-six

SURVEYS

The data in this Chapter is intended to provide an overall understanding of survey functions and their implication on the design of roadway projects. This Chapter will identify the road designer's role in SCDOT's surveying process and provide designers with the basic tools to address and prioritize survey needs, formulate proper survey requests and create base drawings used for design from the survey data. This Chapter is intended to familiarize designers with industry standards and does not describe state-of-the-art surveying methods. Specific information relative to any item of surveying can be obtained through the Surveys Office.

26.1 SURVEY ELEMENTS

26.1.1 Survey Schedule

The determination of the appropriate point in the highway development process to begin field surveys will depend on a variety of factors. The main consideration is the complexity of the project. A new freeway or roadway on new location should be developed to the point that the preliminary location and design studies have been completed before final field survey work begins. For a "C" Project, the designer may submit a county map indicating a project location to the Surveys Office and the survey will be initiated as soon as a location team is available.

26.1.2 Survey Requirements

Designers will analyze projects in depth to determine the exact survey needs to accurately illustrate the proposed improvements on the Final Construction Plans. Designers should consider the type of facilities being planned for improvement and the types of surveys required to achieve the project objective.

Should the project involve existing roads, the use of record plans (i.e., original construction drawings maintained by the Plan Storage Office) is extremely valuable in analyzing the project and survey needs. If available, Final Construction Plans should be used as a resource for existing drainage information.

The following is a list of survey tasks that may be required for a specific roadway project:

1. Aerial Surveys. Aerial surveys are used for horizontal and vertical control for projects being developed through the use of aerial mapping.

2. Bridge Surveys. Surveys that identify elements specific to existing and/or proposed bridges.
3. Centerline Surveys. Surveys that establish existing roadway centerlines and/or proposed centerlines or realignments.
4. Cross Section Surveys. Surveys that identify existing transverse ground lines referenced from a centerline of roadway.
5. Drainage Surveys. Surveys that identify elements of a drainage system or basin. [Figure 26.1A](#) presents a sample culvert survey.
6. Environmental Surveys. Surveys that specifically identify locations and boundaries (e.g., archeological sites, historical sites, wetland areas).
7. Major Traverse Surveys. Independent closed traverse surveys establishing permanent monuments and utilizing existing monumentation, where available.
8. Profile Surveys. Surveys that identify the existing terrain along a centerline of roadway. This may also apply to existing or proposed ditches, channels, etc.
9. Property and Right of Way Surveys. Surveys that identify property lines and right of way widths.
10. Railroad Surveys. Surveys that identify elements along an existing railroad corridor.
11. Subsurface Utility Engineering (SUE). Surveys that identify the precise location of underground utility facilities. They may also include details of aerial utility facilities.
12. Topographic Surveys. Surveys that identify topography within a given corridor.
13. Breakline Surveys. Surveys that identify ground elevation data in place of conventional cross sections by locating existing features such as pavement edges, top and bottom of ditches or ridge lines as a linear feature used for the creation of a digital terrain model.

26.1.3 Public Notification

Prior to making a request for surveys to the Surveys Office, the Program Manager must coordinate the publication of a notice in local papers describing planned project activities. This should be done through the Environmental Management Office and the date of publication should be provided to the Surveys Office along with the survey request.

R.C. BOX CULVERT

COUNTY _____ ROUTE _____ SIZE _____
 APPROACH PAVEMENT WIDTH _____ APPROACH SHOULDER
 WIDTH _____ LOCATION _____
 FOUNDATION _____ BOTTOM SLAB – YES ___ NO ___
 THICKNESS OF INTERIOR (IF NONE, GIVE SIZE OF FOOTING) WALLS _____

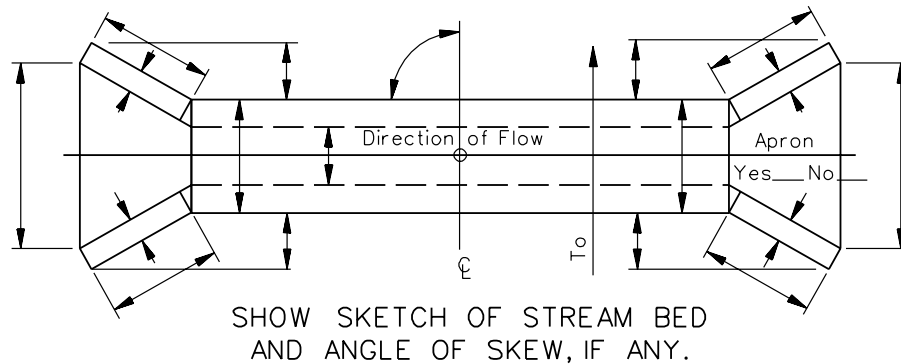
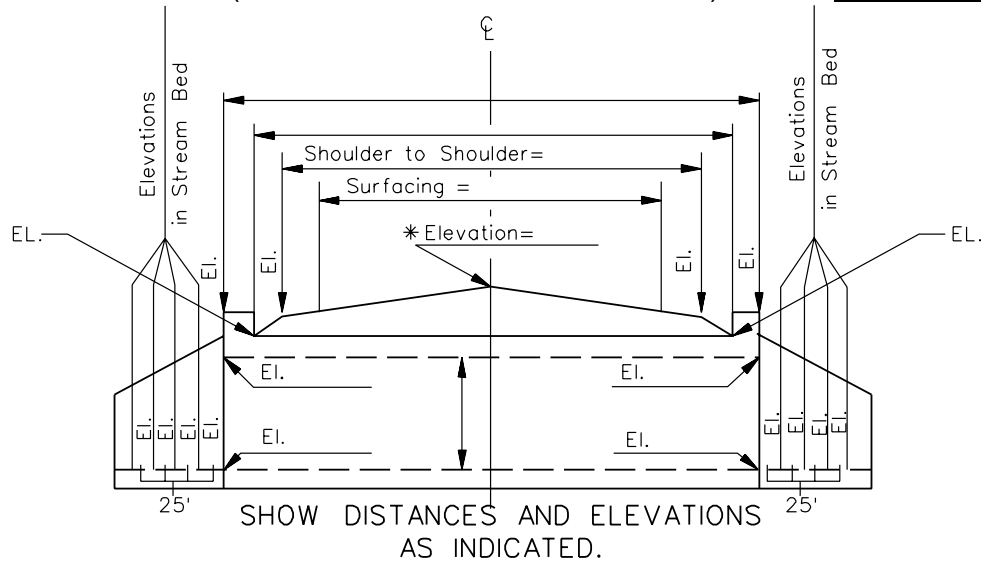

**If no benchmark is available, assume an elevation of 50.00 at the centerline. If a benchmark is available, give the description, location and elevation. If the culvert is a different shape than shown, draw a sketch and use similar dimensions and elevations.*

Note:

1. *If culvert is skewed, state whether distance left and right of centerline is along skew or at right angles to centerline of roadway. Also note whether headwalls are at right angles to centerline of culvert or parallel to centerline of roadway.*
2. *If no bottom slab, give size and sketch of footing on reverse side.*

CULVERT SURVEY
Figure 26.1A

26.1.4 Survey Requests

Surveys are requested from the Surveys Office. The requests are to be made on the following forms:

- Request for Surveys – Roadway (See [Figure 26.1B](#)), and/or
- “C” Project Survey Request (See [Figure 26.1C](#)).

It must include the appropriate roadway and bridge plans, USGS Maps and other support data. Survey crews will collect the necessary information (e.g., tax maps, plats, deeds, easement records) to complete the data research for the survey needs.

In addition to the regular road survey, the following data is required for hydraulic and structural design of culverts and culvert extensions (See [Figure 26.1A](#)):

1. Include a profile of the stream bottom and traverse of stream 400 feet upstream and 400 feet downstream from the centerline of the roadway. At low country, swampy sites where the channel or channels are not well defined, a precise traverse, cross sections and profile will not be necessary. Indicate the general run of the stream within approximately 100 feet of each end of the existing or proposed new culvert.
2. Provide cross sections of the stream channel, extending at least 25 feet beyond each bank at 100-foot intervals along traverse including 25 feet left and right of centerline or 10 feet beyond the culvert ends if the culvert is longer than 50 feet. At low country, swampy sites where the channel or channels are not well defined, a precise traverse, cross sections and profile will not be necessary. Indicate the general run of the stream within approximately 100 feet of each end of the existing or proposed new culvert.
3. Provide a complete sketch showing elevations and dimensions for existing culverts to be widened.
4. Define shoals within 600 feet downstream of the culvert with at least two cross sections taken across the shoal with one additional cross section at each abrupt change in slope of the shoal. Indicate the distance of the shoal from the centerline. The cross section at shoal should be located relative to the traverse.
5. Include the location, owner and type of utility which may be attached to the culvert or which may interfere with the extension of the culvert.
6. Note the names of adjacent property owners.

26.1.5 Horizontal and Vertical Control

Unless otherwise specified, the survey engineer will establish the controls and coordinate for the project to be used in the design.

If it has been determined that a highway project will be tied to the State Plane Coordinate System, the following will apply:

1. All mapping will be tied to the Lambert Conformal Single-Zone South Carolina State Plane Coordinate System based on NAD 83 with all scale factors used provided with the survey.
2. The conversion factor for feet to meters will be based on the international foot, where 1 meter = 3.28083 feet or (100/30.48) feet.
3. In the completed design plans, provide information about existing or new horizontal control monuments used to establish ties to the State Plane Coordinate System for the project. Include the name of the monument, the Northing and Easting coordinates of the monument and all scale factors used by the surveyor.
4. State Plane Coordinates will be computed for all critical points along design alignments (e.g., the beginning and ending PI, PC, PI and PT of all curves). The surveyor will also provide the centerline station for all critical alignment points and all pertinent curve data associated with each curve.
5. All surveys will be tied to one of three vertical datums, an assumed vertical datum, NAVD 1988 or NGVD 1929. The vertical datum used for the project will be provided by the surveyor and will be clearly documented on the Plans for future reference. If the vertical is tied to an old project datum, note the datum used for that project along with Project File Number or Docket Number.

REQUEST FOR SURVEY

Revision 6/4/99

DATE: _____

ROUTE TO: SURVEYS ENGINEER

CC TO: PROGRAM MANAGER _____

COUNTY: _____ CITY/TOWN: _____

ROAD/ROUTE: _____ PROJECT TYPE: _____

FROM: _____ TO: _____

CONSTR. PIN: _____ CHARGE CODE: _____

DATE OF EMINENT DOMAIN ADVERTISEMENT: _____

YES NO

____ THIS REQUEST IS FOR ADDITIONAL SURVEY WORK ON A PREVIOUSLY SURVEYED PROJECT.

COMMENTS: _____

____ PLANS OR OTHER DRAWINGS WITH SPECIFIC INSTRUCTIONS TO IDENTIFY THE SCOPE OF WORK ARE ENCLOSED. NOTE IN COMMENTS WHO PREPARED THESE.

COMMENTS: _____

____ LOCATION MAP IS INCLUDED.

PLEASE COORDINATE THIS REQUEST WITH OTHER SECTIONS TO ADDRESS THAT SECTION'S RELATED SURVEYING NEEDS.

REVIEWED BY	SECTION	DATE
_____	ROAD DESIGN	_____
_____	HYDRAULIC ENGINEERING	_____
_____	TRAFFIC ENGINEERING	_____

FOR ADDITIONAL INFORMATION CONTACT: _____

DESIGN GROUP COORD.: _____ PHONE: _____

PROGRAM MANAGER: _____ PHONE: _____

ASST. PROGRAM MANAGER: _____ PHONE: _____

Revision 6/4/99

COUNTY: _____ CONST. PIN: _____

ROAD/ROUTE: _____

I. RIGHT OF WAY PROPERTY INFORMATION

___ (A) ADDITIONAL RIGHT OF WAY IS ANTICIPATED FOR ALL OR MOST OF THE PROJECT ALIGNMENT.

COMMENTS: _____

___ (B) ADDITIONAL RIGHT OF WAY IS ANTICIPATED ONLY FOR THE AREAS DESIGNATED ON THE ENCLOSED DRAWINGS OR INSTRUCTIONS.

COMMENTS: _____

II. OUTFALL DITCHES AND DRAINAGE

___ (A) SURVEY ALL OUTFALL DITCHES A MINIMUM OF _____ FEET DOWNSTREAM AND _____ FEET UPSTREAM.

COMMENTS: _____

___ (B) DO NOT SURVEY OUTFALL DITCHES AT THIS TIME. WILL BE REQUESTED AT A FUTURE DATE THROUGH HYDRAULIC ENGINEERING SECTION OR AFTER ADDITIONAL STUDY IF NEEDED.

COMMENTS: _____

III. INTERSECTING ROADS

___ (A) SURVEY ALL INTERSECTING ROADS A MINIMUM OF _____ FEET.

COMMENTS: _____

___ (B) SURVEY INTERSECTING ROADS ONLY AS INDICATED ON THE ENCLOSED DRAWINGS/PLANS.

COMMENTS: _____

REQUEST FOR SURVEYS – ROADWAYS

(Continued)

Figure 26.1B

COUNTY: _____ CONST. PIN: _____

ROAD/ROUTE: _____

IV. CROSS SECTIONS

___ (A) EXTEND CROSS SECTIONS _____ FEET LEFT AND _____ FEET RIGHT OF SURVEY CENTERLINE, AT INTERVALS SHOWN UNDER COMMENTS.

COMMENTS: _____

___ (B) EXTEND CROSS SECTIONS _____ FEET LEFT AND _____ FEET RIGHT OF INTERSECTING ROAD CENTERLINES, AT INTERVALS SHOWN UNDER COMMENTS.

COMMENTS: _____

___ (C) SEE ENCLOSED DRAWINGS/PLANS FOR INTERSECTING ROAD CROSS SECTION WIDTHS.

V. BRIDGES - APPROPRIATE BRIDGE DATA FORM SHOULD BE INCLUDED FOR ANY OF THE FOLLOWING THAT APPLY.

___ (A) REPLACE BRIDGE OVER STREAM ON SAME LOCATION.

___ (B) REPLACE BRIDGE OVER STREAM ON NEW LOCATION.

___ (C) WIDEN BRIDGE AT STREAM CROSSING

___ (D) WIDEN BRIDGE OVER RAILROAD

___ (E) REPLACE BRIDGE OVER RAILROAD

___ (F) CULVERT STRUCTURAL AND/OR HYDRAULIC DESIGN

VI. OTHER

___ (A) _____

___ (B) _____

___ (C) _____

REQUEST FOR SURVEYS – ROADWAYS

(Continued)

Figure 26.1B

"C" Project Survey Request

Date: _____ Requested By: _____

Project PIN: _____ County: _____

Road: _____ Length: _____

Survey Allotment: _____ Road Group Design Classification: _____

Maximum Degree of Horizontal Curves: _____

Horizontal Alignment Remarks: _____

Drainage Survey Remarks: _____

Stake Right of Way? _____ Width: _____ Interval: _____

Right of Way Staking Remarks: _____

Other Survey Instructions and Remarks: _____

The following items need to be included with this request. Indicate Yes or No whether or not you have included them.

Location Map: _____ Evaluation Report: _____

Plan Sheets As Needed for Survey Extensions or Revisions: _____

Other Additional Written Instructions & Guidelines for Survey: _____

Please list any other enclosures: _____

26.1.6 Base Plans

The designer should use the base topographic mapping or other survey source materials to develop the proposed survey centerline. The Road Design Group will maintain all original plan sheets and transmit copies to the Preliminary Design Group, as needed.

For collectors, local roads, "C" Projects and less complicated projects, the actual survey notes may represent the entire source of data for the development of the contract drawings. For more complex projects, aerial mapping and planimetric plots (e.g., hard copies, compact discs) may be available for preliminary planning. This material must ultimately be supported by field survey data, the requirements of which will be established by the designer.

26.1.6.1 Development Methods

For the conventional-plotted base sheets all topographic data (e.g., fence corner, power pole, mailbox, 10-inch oak) will be noted on the plans via station and offset from the survey centerline. Station and offset are shown on the Plans 90 degrees to the survey centerline and left and right of the centerline, as appropriate. If there is an extensive amount of topographic information, it can be shown in tabular form. See the *Road Design Plan Preparation Guide*.

For the computer-plotted method, the same requirements listed under conventional plotted base sheets apply to all computer plotted base sheets originating from survey data collectors and/or conventional survey methods. Station and offset text may be computer-generated or hand-lettered and may be shown in tabular form.

Developing base sheets through aerial mapping procedures will require surveyed monument points in the field or stringently controlled traverses wherein identifiable photographic points are coordinated. Even though the resulting topographic mapping data are very accurate, selective station and offset text for all topographic points is required. Examples include large stately trees, house/porch corners, wells and any features not identified by the aerial mapping, all of which may lie within a few feet of the new right of way.

The method by which the project will be developed must be determined in the early stages of project development. No method of base plan development can be completed without additional field survey requirements.

26.1.6.2 Aerial Mapping

Because a significant amount of field survey data is required to produce the finished product, the decision to obtain aerial mapping for a project is based on a thorough analysis of the project characteristics. Little benefit is gained with aerial mapping of rural secondary roads having little or infrequent development along the route. Conversely projects near high-density development would benefit greatly from aerial mapping because of accurate coordinated horizontal control (i.e., mapping plotted on pre-determined grid system), vertical control through spot elevations, and/or contours at predetermined intervals. This would reduce conventional survey requirements using survey instruments significantly. Accurate contours and spot elevations generally cannot be accomplished in high-density forested areas.

The individual requesting this service should have a thorough knowledge of the aerial mapping industry standards and procedures for development. The scope of work, mapping requirements, and data-collection methods are significantly different for conventional aerial mapping manuscripts and aerial mapping data to be used for computer-generated terrain models.

26.1.7 Survey Files

The Surveys Office provides several types of survey information to the Road Design Group. The following are the three main types:

1. NEW Files. The survey file with the NEW extension is the main survey data file. This survey file will include a description of the project, the total length of survey and an index of point numbers used by the survey crew. It also contains coordinates of all topography features and cross-section shots.
2. ALG Files. The survey file with the ALG extension is a file that contains the horizontal alignments beginning station, description and the points that make up the tangent and curve elements of the alignment. If the Surveys Office does not supply this file, then the designer will have to use the SAS program to create this file.
3. Hand Notes. Besides survey-data files, the survey crew will send in additional hand-field notes. These may include tax maps, property information, right of way information, horizontal alignment information, curve data, bearings, reference points, benchmarks, drainage recommendations, utility information and any additional alignment and topography not surveyed electronically. It is the responsibility of the Road Design Groups to insure that any pertinent information that is manually taken by the Survey Crew is incorporated in the Plans.

If additional surveys are received for a project, the new survey files should be integrated into the original survey files by following the procedure found in the *Road Design CADD User Guide*.

For additional information on survey files, see the *Road Design Plan Preparation Guide* and for additional information on electronic survey collection methods and survey codes, see SCDOT's *Electronic Survey Data Collection Feature Codes and Procedures*.

26.2 SURVEY REQUIREMENTS

The following Sections highlight specific items that designers must be familiar with in order to properly organize survey needs to address the requirements of other support Sections and affected railroads.

26.2.1 Utilities

The standard survey practice of accurately finding the location and elevation of all aboveground utility topography will be required for most projects. For other projects, where the location of underground utilities is considered critical to the design process, Subsurface Utility Engineering (SUE) services should be used.

SUE is a method for identifying the location of subsurface utilities at various levels of quality. Each quality level is defined by the thoroughness, accuracy and methods used in gathering the subsurface utility information.

A representative of the Utilities Office, working with the SUE firm as well as the Project Development Team, will determine the extent of utility delineation and appropriate quality levels needed based on the utility information available, utility risks and project budgetary constraints. Once the Department has contracted with the SUE firm for the required quality level(s), the SUE firm will be responsible for obtaining some or all of the following utility information in accordance with the current Department SUE CADD standards and will be responsible for the negligent errors or omissions in the data:

- utility ownership information for all utilities within the project limits,
- location of all underground utilities,
- location of all aboveground utility topography,
- location of all utility poles including identification number,
- location of all aerial utility facilities, and
- utility details as required by the standard utility data sheets.

The following are the four SUE quality levels as defined by the Federal Highway Administration (FHWA):

1. Quality Level D. This level information comes solely from existing utility records. It may provide an overall “feel” for the congestion of utilities, but it is often highly limited in terms of comprehensiveness and accuracy. Its usefulness should be confined to project planning and route selection activities.
2. Quality Level C. This level involves surveying visible aboveground utility facilities (e.g., manholes, valve boxes, posts) and correlating this information with existing utility records. When using this information, it is not unusual to find that many underground utilities have been either omitted or erroneously plotted. Its

usefulness, therefore, should be confined to rural projects where utilities are not prevalent, or are not too expensive to repair or relocate.

3. Quality Level B. This level involves the use of surface geophysical techniques to determine the existence and horizontal position of underground utilities. This activity is called “designating.” Two-dimensional mapping information is obtained. This information is usually sufficient to accomplish preliminary engineering goals. Decisions can be made on where to place storm drainage systems, footers, foundations and other design features in order to avoid conflicts with existing utilities. Slight adjustments in the design can produce substantial cost savings by eliminating utility relocations.
4. Quality Level A. This level involves the use of nondestructive digging equipment at critical points to determine the precise horizontal and vertical position of underground utilities, as well as the type, size, condition, material and other characteristics. This activity is called “locating.” It is the highest level presently available. When surveyed and mapped, precise plan and profile information are available for use in making final design decisions. By knowing exactly where a utility is positioned in three dimensions, the designer can often make small adjustments in elevations or horizontal locations and avoid the need to relocate utilities. Additional information (e.g., utility materials, condition, size, soil contamination, paving thickness) also assists the designer and Utility Company in their decisions.

Additional information on utilities is provided in [Chapter 5](#).

26.2.2 Existing Roadways

On projects involving the improvements of existing roads, it is desirable to re-create the existing horizontal and vertical alignment. Existing stationing may be re-created or new stationing may be established. It may be advantageous to re-create existing stationing where feasible, thus making it easier to check plan data for “completion and correctness” from the Final Construction Plans. Re-creation of the horizontal alignment will establish the exact position and limits of existing right of way, which is required in the development of Final Right of Way Plans. Should traffic create hazardous surveying conditions, offset baselines may be established and the roadway alignment and right of way may be computed with the aid of roadway centerline shots, property pins, right of way monuments, etc. If relocations are planned, alignments can be graphically depicted on prints of record plans with proposed horizontal curves and controls, as appropriate.

On widening and resurfacing projects, cross sections on 50-foot increments, through horizontal curves, should be continued until normal crown sections are reached. This will enable designers to analyze lengths of superelevation runoff and runoff and compare them to current criteria.

26.2.3 Railroads

It is imperative that designers understand the requirements of the Railroad Companies. Additional information on Railroad Company requirements is provided in [Chapter 6](#). All projects that require land acquisition or encroachment permits from a Railroad Company will require the following survey information for plan development:

- location of all railroad appurtenances,
- existing drainage structures and flow patterns,
- railroad right of way, and
- all mile markers within the project or reference to the nearest railroad mile marker (milepost shot must tie to something).

If a project involves a parallel encroachment on the railroad right of way, include the following information in the survey:

- distance to tracks (all measurements are referenced from the centerline of the tracks),
- cross sections from road project to mainline tracks showing ground line and top of rail elevations,
- topography to the mainline tracks,
- all drainage structures and channels between the road project and mainline tracks with elevations of flow line and top of structures, and
- nearest railroad right of way line to road project.

If a project involves a grade separated crossing, include a traverse on the centerline of the railroad for a minimum of 200 feet left and 200 feet right of the roadway survey centerline with appropriate topography and cross sections at 25-foot intervals.

26.2.4 Environmental

The individuals requesting surveys must be familiar with the project in order to obtain specific survey information relative to environmental issues. They must be cognizant of potential problem areas (e.g., hazardous waste sites, old landfills, underground storage tanks, wetlands, historical site) in order to request sufficient survey data to accurately reflect the location and limits of these features. The Environmental Management Office should be notified to delineate the wetlands in the project area prior the beginning of the surveys.

26.2.5 Property

Necessary property closures will be developed by the survey parties and graphically depicted in the plans by the designer.

26.3 REFERENCES

1. *Road Design Plan Preparation Guide*, SCDOT, 2000.
2. *South Carolina Department of Transportation Survey Manual*, SCDOT, current edition.

Table of Contents

<u>Section</u>	<u>Page</u>
27.1 INTRODUCTION	27.1(1)
27.2 DEFINITIONS	27.2(1)
27.3 CLASSES OF ACTION	27.3(1)
27.3.1 Background	27.3(1)
27.3.2 Categorical Exclusion	27.3(1)
27.3.3 Environmental Assessment	27.3(2)
27.3.4 Environmental Impact Statement	27.3(2)
27.4 SPECIAL ENVIRONMENTAL ANALYSES	27.4(1)
27.4.1 Section 4(f) Evaluations	27.4(1)
27.4.1.1 Definitions	27.4(1)
27.4.1.2 Application	27.4(1)
27.4.2 Section 6(f) Conversions	27.4(2)
27.4.3 Section 106 (Historic Preservation) Compliance	27.4(2)
27.4.4 Noise Analyses	27.4(3)
27.4.5 Flood Plain Finding	27.4(3)
27.4.6 Wetland Analyses	27.4(3)
27.4.7 Threatened and Endangered Species	27.4(4)
27.4.8 Air Quality Conformance	27.4(4)
27.4.9 Hazardous Material	27.4(5)
27.5 PERMITS	27.5(1)
27.5.1 Section 404 Permit	27.5(1)
27.5.2 Section 9 Permit	27.5(1)
27.5.3 Section 10 Permit	27.5(1)
27.5.4 Section 401 Water Quality Certification	27.5(1)
27.5.5 Section 402 Permit	27.5(1)
27.5.6 State Permits	27.5(2)
27.6 ACRONYMS	27.6(1)
27.7 REFERENCES	27.7(1)

Chapter Twenty-seven

ENVIRONMENTAL PROCEDURES

27.1 INTRODUCTION

The Environmental Management Office is responsible for a variety of activities related to environmental impacts and procedures. This includes air, noise and water quality analyses; social, economic, biological, archeological and historical impacts; preparation of environmental documents for SCDOT projects; evaluation and mitigation of hazardous waste sites; and the public's involvement with the environmental document. The Environmental Management Office coordinates with the applicable Federal or State agencies to process the environmental documentation and permit applications.

It is important for the road designer to understand the various environmental activities and procedures to insure that the proper environmental documentation and permits are completed as part of the project development. The entire Project Development Team is responsible for calling attention to potential environmental issues throughout the development of the project. The need to receive one or more permits or approvals can significantly affect the project schedule.

27.2 DEFINITIONS

The following presents the definitions of the more common terms used in environmental procedures:

1. Council of Environmental Quality (CEQ). The CEQ is composed of three members appointed by the President; it maintains a quality awareness of the nation's environmental resources. The CEQ oversees the implementation of the *National Environmental Policy Act (NEPA)* by issuing regulations (40 CFR Parts 1500-1508) to guide all Federal agencies.
2. National Environmental Policy Act (NEPA). NEPA, as amended, is a Federal environmental statute that requires the consideration of environmental factors through a systematic, interdisciplinary approach before committing to a course of action, the procedures are set forth in CEQ regulations and 23 CFR Part 771.
3. 23 CFR 771. This is a Federal regulation that prescribes the policies and procedures of the FHWA and the Federal Transit Administration (FTA) for implementing NEPA, as amended, and the regulations of the CEQ, 40 CFR Parts 1500 through 1508. This regulation sets forth all FHWA and FTA requirements under NEPA for the processing of highway and urban mass transportation projects.
4. Action. For purposes of 23 CFR 771, this is a highway project proposed for FHWA funding. It also includes activities (e.g., joint and multiple-use permits, changes in access control) that may or may not involve a commitment of Federal funds. For Federal flood plain regulations, "action" is any highway construction, reconstruction, rehabilitation, repair or improvement undertaken for Federal-aid/regulating projects.
5. Base Flood. The flood or tide having a 1-percent chance of being exceeded in any given year.
6. Categorical Exclusion (CE). A category of actions that do not individually or cumulatively have a significant effect on the human environment for which, neither an Environmental Assessment nor an Environmental Impact Statement is required.
7. Environmental Assessment (EA). A concise public document, for which a Federal agency is responsible, that serves to briefly provide sufficient evidence and analyses for determining whether to prepare an Environmental Impact Statement or a Finding of No Significant Impact.
8. Environmental Impact Statement (EIS). A detailed written statement, prepared for major Federal actions significantly affecting the quality of the human environment, which discusses the environmental impact of the proposed action;

- any adverse environmental effects which cannot be avoided should the proposal be implemented; alternatives to the proposed action; the relationship between local short-term uses of man's environment and the maintenance and enhancement of long-term productivity; and any irreversible and irretrievable commitments of resources that would be involved in the proposed action should it be implemented.
9. Finding of No Significant Impact (FONSI). A document by a Federal agency briefly presenting the reasons why an action, not otherwise excluded, will not have a significant impact on the human environment and for which an Environmental Impact Statement therefore will not be prepared.
 10. Lead Agency. The agency or agencies preparing or having assumed primary responsibility for preparing the environmental document.
 11. National Register of Historic Places. The National Register is a database of properties that are considered historic and otherwise preserved by Section 106 historic preservation regulations. The Secretary of the US Department of the Interior maintains and establishes the criteria by which properties are evaluated for the National Register of Historic Places.
 12. Record of Decision (ROD). A FHWA document, prepared after the publication of the Final EIS, which a) presents the basis for the decision (i.e., the selected alternative), b) summarizes any mitigation measures that will be incorporated into the project and c) documents any required Section 4(f) approval.
 13. Regulatory Floodway. The flood plain area that is reserved in an open manner by Federal, State or local requirements (i.e., unconfined or unobstructed either horizontally or vertically) to provide for the discharge of the base flood so that the cumulative increase in water surface elevation is no more than a designated amount, not to exceed one foot, as established by the Federal Emergency Management Agency (FEMA) for Administering the National Flood Insurance Program.
 14. Scoping. An early and open process for determining the scope of issues to be addressed in the environmental document and for identifying potential issues related to the proposed action. Scoping is intended to focus the study effort on issues that are important.
 15. Significant Flood Plain Encroachment. A highway encroachment and any direct support of likely base flood plain development that would involve one or more of the following construction- or flood-related impacts:
 - a significant potential for interruption or termination of a transportation facility which is needed for emergency vehicles or provides a community's only evacuation route,

- a significant risk, or
 - a significant adverse impact on natural and beneficial flood plain values.
16. Wetlands (Federal). Areas inundated or saturated by surface or ground water at a frequency and duration sufficient to support, and that under normal circumstances do support, a prevalence of vegetation typically adapted for life in saturated soil conditions. Wetlands generally include swamps, marshes, bogs and similar areas.

27.3 CLASSES OF ACTION

27.3.1 Background

Section 23 of the *Code of Federal Regulations* (CFR), Part 771 is the Federal regulation that prescribes the policies and procedures of the Federal Highway Administration (FHWA) and the Federal Transit Administration (FTA) for implementing the National *Environmental Policy Act of 1969* (NEPA). NEPA, as amended, is a Federal environmental statute that requires the consideration of environmental factors through a systematic, interdisciplinary approach before committing to a course of action when Federal funds are involved. The regulation calls for specific environmental documentation to insure that the policies and goals defined in NEPA are incorporated into the ongoing programs and actions of SCDOT. An action is any highway project proposed for FHWA funding. There are three classes of actions that determine the level of environmental documentation required in the NEPA process. These are discussed in the following sections.

27.3.2 Categorical Exclusion

A Categorical Exclusion (CE) project is a Class II action. Class II actions do not, either individually or cumulatively, significantly impact human health and the environment and are excluded from the requirement to prepare an Environmental Assessment (EA) or an Environmental Impact Statement (EIS). CE projects typically:

- do not induce significant impacts to planned growth or land use for the area;
- do not require the relocation of significant numbers of people;
- do not have a significant impact on any natural, cultural, recreational, historic or other resource;
- do not involve significant air, noise or water quality impacts;
- do not involve significant impacts on travel patterns; or
- do not otherwise, either individually or cumulatively, have any significant environmental impacts and are excluded from the requirement to prepare an EA or EIS.

A specific list of CE actions normally not requiring NEPA documentation is provided in 23 CFR Part 771, Section 117(c).

27.3.3 Environmental Assessment

Environmental Assessment (EA) is considered a Class III action. An EA is an environmental document for actions in which the significance of the environmental impact is not clearly established. Any action that is determined not to be a Categorical Exclusion or require an Environmental Impact Statement requires an Environmental Assessment. All actions of this type require an EA in order to determine which other type of environmental document may be needed to satisfy the NEPA process (e.g., EIS or FONSI).

27.3.4 Environmental Impact Statement

Environmental Impact Statement (EIS) is a Class I action. Class I actions significantly impact human health and the environment. An EIS is a written detailed statement that discusses the environmental impact of the proposed action, any adverse environmental effects which cannot be avoided should the proposal be implemented, alternatives to the proposed action, and any irreversible and irretrievable commitments of resources which would be involved in the proposed action should it be implemented. A new controlled access freeway or a highway project of four or more lanes on a new location are typical examples of actions that require an EIS.

27.4 SPECIAL ENVIRONMENTAL ANALYSES

Although the *National Environmental Policy Act* (NEPA) is the major mandate for environmental considerations, there are other laws, executive orders, regulations, agreements, etc., which require special studies, analyses, coordination and documentation on specific environmental issues.

Special environmental analyses provide the technical data and information necessary to identify and evaluate the nature and extent of specific environmental impacts of a proposed action (and associated mitigation measures that may be appropriate).

27.4.1 Section 4(f) Evaluations

27.4.1.1 Definitions

The following presents the definitions of the more common terms used in a Section 4(f) Evaluation:

1. Section 4(f) Approval. A finding that there is no feasible and prudent alternative to use of Section 4(f) land and that all possible planning to minimize harm to Section 4(f) land is included in the proposed action.
2. Section 4(f) Evaluation. Documentation of the involvement a project would have with Section 4(f) land, addressing alternatives to use of the land and measures to minimize any harm that would result from their use.
3. Section 4(f) Land. Land protected under 49 USC 303 (Section 4(f) of the *USDOT Act of 1966*) (i.e., any significant publicly owned park, recreational area or wildlife and waterfowl refuge or a historic site of national, State or local significance). The Federal, State or local officials having jurisdiction over the park, recreational area, refuge or site determine its significance. The term "historic site" includes both historic and prehistoric archaeological sites determined important for preservation in place.

27.4.1.2 Application

A Section 4(f) evaluation is a Federal requirement that applies only to projects involving funding, an approval, or permit from an agency of the US Department of Transportation (USDOT) (e.g., Federal Highway Administration, US Coast Guard).

A proposed project involving the use of land from a publicly owned park, recreational area, wildlife and waterfowl refuge or any land from a historic site will require special analyses for compliance with Section 4(f) of the *Department of Transportation Act of 1966*. These special analyses are documented in a Section 4(f) Evaluation during

project development, addressing alternatives and measures to minimize any harm that would result from use of Section 4(f) land.

27.4.2 Section 6(f) Conversions

Section 6(f) Lands are lands that have Land and Water Conservation Funds (LWCF) involved in their purchase or development. LWCF is a dedicated fund providing grants to States for outdoor recreational facilities. Special procedures are required when Section 6(f) lands are used for highway purposes.

Requests to convert LWCF-assisted properties in whole or in part to other than public outdoor recreational uses must be submitted to the National Park Service (NPS). NPS will consider the conversion request if certain prerequisites have been met. In general, the following are examples of the types of prerequisites deemed appropriate by NPS:

- All practical alternatives to the proposed conversion have been evaluated.
- The fair market value of the property to be converted has been established and the property proposed for substitution is of at least equal fair market value as established by an approved appraisal excluding the value of structures or facilities that will not serve a recreational purpose.
- The property proposed for replacement is of reasonably equivalent usefulness and location as that being converted.
- The guidelines for environmental evaluation have been satisfactorily completed and considered by NPS during its review of the proposed 6(f) action.

27.4.3 Section 106 (Historic Preservation) Compliance

Section 106 of the *National Historic Preservation Act* requires agencies using Federal funds to review the effect their actions may have on historic properties that are listed in or eligible for the National Register of Historic Places. These review procedures are referred to as the Section 106 process and are issued by the Advisory Council on Historic Preservation (36 CFR Part 800). Coordination with the State Historic Preservation Office is essential in the Section 106 process.

The basic steps of the Section 106 Process are:

1. Identification and Evaluation. Historic properties are identified in the area of potential effects of a proposed highway undertaking as early as practical in the development of the undertaking.

2. Effect Determination. For all historic properties in the area of potential effects of a highway undertaking, the effects of the undertaking must be assessed.
3. Consultation. If an adverse effect is found, the Department will notify the Advisory Council on Historic Preservation and will initiate consultation. Members of the public also are allowed an opportunity to comment.
4. Agreement and Council Comment. If all agencies involved (e.g., FHWA, SCDOT, Advisory Council on Historic Preservation) agree upon ways to avoid or reduce adverse effects or agree to accept the effects, they execute a Memorandum of Agreement.
5. Proceed. The undertaking is implemented according to the terms of the Agreement.

27.4.4 Noise Analyses

In the development of a project, it may be necessary to undertake special technical analyses to identify and evaluate the potential noise impacts the project will involve. Section 23 CFR Part 772 prescribes the procedures for these analyses and for alternative noise abatement measures to mitigate impacts, giving weight to the benefits and cost of abatement, and to the overall social, economic and environmental effects.

27.4.5 Flood Plain Finding

Specific procedures apply to all Federal-aid regulated projects that will entail encroachment or which otherwise will affect base flood plains, except for repairs made with emergency funds during or immediately following a disaster. The assessment of flood plain encroachments should be incorporated into the development and analysis of corridor and design alternatives so that flood plain impacts will not be considered in isolation from other social, economic, environmental and engineering considerations. A project of this type will require the preparation of an EA or EIS.

27.4.6 Wetland Analyses

Section 404 of the *Clean Water Act* establishes programs to regulate the discharge of dredged and fill material into waters of the United States, including wetlands. Activities in waters of the United States that are regulated under this program include fills for development, water resource projects (e.g., dams, levees), infrastructure development (e.g., highways, airports), and conversion of wetlands to uplands for farming and forestry.

A permit review process controls regulated activities. An individual permit is usually required for potentially significant impacts. However, for most discharges that will have only minimal adverse effects, the Army Corps of Engineers often grants up-front general permits. These may be issued on a nationwide, regional or statewide basis for particular categories of activities (e.g., minor road crossings, utility line backfill and bedding) as a means to expedite the permitting process.

Specifically, wetland analyses are required for the following classes of activities:

- dams or dikes in navigable waters of the United States;
- other structures or work including excavation, dredging and/or disposal activities in navigable waters of the United States;
- activities that alter or modify the course, condition, location or capacity of a navigable water of the United States;
- construction of artificial islands, installations and other devices on the outer continental shelf;
- discharges of dredged or fill material into waters of the United States;
- activities involving the transportation of dredged material for the purpose of disposal in ocean waters; and
- nationwide general permits for certain categories of activities.

27.4.7 Threatened and Endangered Species

In the development of a project, special studies and coordination are required to review the impacts on species of plants or animals listed at the Federal level as threatened or endangered. Every effort should be made to minimize the likelihood of jeopardizing the continued existence of listed threatened or endangered species or the destruction or adverse modification of an area of habitat that has been designated as critical habitat or essential habitat.

27.4.8 Air Quality Conformance

All transportation plans, programs and projects that use Federal funds must be determined to conform to Federal air implementation plans. These implementation plans describe how air quality standards will be achieved in those areas of a State in which standards are being exceeded. Conformity to an implementation plan is defined in the *Clean Air Act* as conformity to an implementation plan's purpose of eliminating or reducing the severity and number of violations of the national ambient air quality

standards and achieving expeditious attainment of these standards. The implementing regulations for determining conformity of transportation projects also impose requirements upon “regionally significant projects” in nonattainment areas regardless of whether these projects involve Federal funds or approvals. If the project is in the State Transportation Improvement Plan, it is in compliance.

“Regionally significant projects” are transportation projects, other than exempted projects, that are on facilities which serve regional transportation needs (e.g., access to and from the area outside of the region, major activity centers in the region, major planned developments such as new retail malls, sports complexes, etc.) and would normally be included in the modeling of a metropolitan area’s transportation network, including all principal arterial highways.

27.4.9 Hazardous Material

Hazardous materials are defined as underground storage tanks (UST), asbestos and hazardous waste storage sites, etc. which (1) cause or contribute to an increase in mortality or serious illness or (2) pose present or potential hazards to human health or the environment.

On all projects requiring new rights of way or property purchases, it is imperative that the presence of hazardous materials be identified as early as possible in the project development so that these sites can be avoided, if possible, or necessary clean-up can take place prior to construction. The Right of Way Office will coordinate with the South Carolina Department of Health and Environmental Control (DHEC), as necessary, to address these sites. For further information, see [Chapter 30](#).

27.5 PERMITS

When construction activities performed by the SCDOT impact the environment, navigation, public land or private land, the Department may be required to obtain a permit, certification, approval, etc., during the design phase of a project. Several of these permits are discussed in the following Sections.

27.5.1 Section 404 Permit

Section 404 Department of the Army Permit (DA Permit) is obtained from the U.S. Army Corps of Engineers for the discharge of dredge or fill material into waters of the United States, including adjacent wetlands. In general, for identification, the “waters of the US” includes all wetlands and areas within a blue solid line or a blue dash line on the USGS quadrangle maps. Note that each Corps District has its own procedures and permit requirements.

27.5.2 Section 9 Permit

The Section 9 permit is obtained from the U.S. Coast Guard for construction of bridges or causeways in interstate navigable waters of the United States.

27.5.3 Section 10 Permit

The Section 10 Permit is obtained from the U.S. Army Corps of Engineers for structures or work, other than bridges and causeways, affecting the navigable waters of the U.S.

27.5.4 Section 401 Water Quality Certification

By Federal law every applicant for a Federal permit or license for an activity which may result in a discharge into a water body must request State certification to insure that the proposed activity will not violate State and Federal water quality standards. A Section 401 Certification is required when a Section 404 permit is required.

27.5.5 Section 402 Permit

The Section 402 National Pollutant Discharge Elimination System (NPDES) Point-Source Permit is required for projects that involve a point-source discharge of pollutants into waters of the United States.

27.5.6 State Permits

The South Carolina Office of Coastal Resource Management (OCRM) requires certain specialized permits when a State highway construction project is located in a coastal county. The following provides a description of these permits:

1. OCRM Critical Area Permit. This permit is for any alteration of saltwater marshes in the coastal counties.
2. Coastal Zone Consistency Certification. This is a required certification for any project in a coastal county that is outside of the critical area and requires a State or Federal permit.

27.6 ACRONYMS

The evolution of environmental procedures has generated a considerable number of acronyms. These have been created for the names of many Federal and State agencies, laws, studies, terms, etc. The following identifies the more significant acronyms which have gained common usage:

1. AASHTO. American Association of State Highway and Transportation Officials.
2. ACHP. Advisory Council on Historic Preservation.
3. ADA. *Americans with Disabilities Act*.
4. BMP. Best Management Practices.
5. CAAA. *Clean Air Act Amendments*.
6. CE. Categorical Exclusion.
7. CERCLIS. Comprehensive Environmental Response, Compensation and Liability Information System.
8. CEQ. Council on Environmental Quality.
9. CFR. *Code of Federal Regulations*.
10. CWA. *Clean Water Act*.
11. CZM. Coastal Zone Management.
12. DEIS. Draft Environmental Impact Statement.
13. DHEC. (South Carolina) Department of Health and Environmental Control.
14. DOI. (United States) Department of Interior.
15. EA. Environmental Assessment.
16. EIS. Environmental Impact Statement.
17. EO. Executive Order.
18. EPA. (United States) Environmental Protection Agency.
19. ESA. (Federal) *Endangered Species Act*.
20. FEIS. Final Environmental Impact Statement.
21. FEMA. Federal Emergency Management Agency.

22. FHWA. Federal Highway Administration.
23. FONSI. Finding of No Significant Impact.
24. FTA. Federal Transit Administration (Note: This was formerly the Urban Mass Transit Administration (UMTA)).
25. FWCA. *Fish and Wildlife Coordination Act*.
26. FWPCA. *Federal Water Pollution Control Act*.
27. FWS. (United States) Fish and Wildlife Service.
28. LUST. Leaking Underground Storage Tank.
29. LWCF. *Land and Water Conservation Fund (Act)*.
30. NAAQS. National Ambient Air Quality Standards.
31. NEPA. *National Environmental Policy Act*.
32. NPDES. National Pollutant Discharge Elimination System.
33. NPS. National Park Service.
34. NRCS. Natural Resources Conservation Service (Note: This was formerly the Soil Conservation Service (SCS)).
35. NRHP. National Register of Historic Places.
36. NWP. Nationwide (Section 404) Permit.
37. OEPC. (DOI) Office of Environmental Policy and Compliance.
38. PESA. Preliminary Environmental Site Assessment.
39. RCRA. *Resource Conservation and Recovery Act*.
40. REO. (DOI) Regional Environmental Officers.
41. ROD. Record of Decision.
42. SARA. *Superfund Amendments and Reauthorization Act*.
43. SDWA. *Safe Drinking Water Act*.
44. SEE. Social, Economic and Environmental.
45. SHPO. State Historic Preservation Officer.

46. SWA. Special Waste Assessment.
47. USC. *United States Code*.
48. USACOE. United States Army Corps of Engineers.
49. USCG. United States Coast Guard.
50. USDA. United States Department of Agriculture.
51. UST. Underground Storage Tank.

27.7 REFERENCES

1. *Code of Federal Regulations, 23 CFR Parts 1500-1508*, "Council on Environmental Quality."
2. *Code of Federal Regulations, 23 CFR 771*, "Environmental Impact and Related Procedures."
3. *FHWA Technical Advisory T6640.8A*, "Guidance for Preparing and Processing Environmental and Section 4(f) Documents," FHWA, 1987.
4. *Executive Office of President, Council on Environmental Quality*, "Memorandum for Federal NEPA liaisons, Federal, State, and Local Officials and other Persons involved in the NEPA Process," 1981.
5. *Federal Highway Administration*, "4(f) Policy Questions and Answers," undated.
6. *Federal Register, Volume 48, No. 163*, "Programmatic Section 4(f) Evaluations and Approval for FHWA Projects that Necessitate the Use of Historic Bridges," 1983.

Table of Contents

<u>Section</u>	<u>Page</u>
28.1 HIGHWAY GEOMETRY	28.1(1)
28.2 HIGHWAY CAPACITY	28.2(1)
28.3 TRAFFIC CONTROL DEVICES	28.3(1)
28.3.1 <i>Manual on Uniform Traffic Control Devices</i>	28.3(1)
28.3.2 Signs	28.3(2)
28.3.2.1 General	28.3(2)
28.3.2.2 Sign Application	28.3(2)
28.3.2.3 Sign Priority	28.3(2)
28.3.2.4 Placement	28.3(3)
28.3.3 Pavement Markings	28.3(5)
28.3.3.1 General	28.3(5)
28.3.3.2 Line Types	28.3(6)
28.3.3.3 Material Types	28.3(6)
28.3.3.4 Pavement Markings for Bridge Plans	28.3(10)
28.3.4 Traffic Signals	28.3(10)
28.3.4.1 General	28.3(10)
28.3.4.2 Traffic Signal Warrants	28.3(11)
28.3.4.3 Traffic Signal Studies	28.3(11)
28.3.4.4 Traffic Signal Equipment	28.3(11)
28.4 WORK ZONE TRAFFIC CONTROL	28.4(1)
28.4.1 Purpose	28.4(1)
28.4.2 Coordination	28.4(1)
28.5 INTELLIGENT TRANSPORTATION SYSTEMS (ITS)	28.5(1)
28.6 RAILROAD CROSSINGS	28.6(1)
28.7 HIGHWAY LIGHTING	28.7(1)

Table of Contents

(Continued)

<u>Section</u>	<u>Page</u>
28.8 TRAFFIC CALMING	28.8(1)
28.9 REFERENCES	28.9(1)

Chapter Twenty-eight

TRAFFIC ENGINEERING

Traffic devices are necessary for the safe and orderly use of the roadway system. The major factors that affect traffic operations include:

- highway geometry,
- highway capacity,
- traffic control devices,
- work zone traffic control,
- Intelligent Transportation Systems (ITS),
- railroad crossings,
- highway lighting, and
- traffic calming.

This Chapter provides a general discussion of some important traffic engineering issues. For more information, refer to the publications described in each of the following Sections.

28.1 HIGHWAY GEOMETRY

Early coordination with the traffic engineer is required to insure:

- intersection lane arrangements account for changing traffic patterns,
- construction staging is feasible,
- signal and ITS needs are evaluated,
- signing and pavement markings are feasible, and
- bicycle and pedestrian needs are met.

The road designer should refer to [Chapter 15](#) for additional information on intersections. Adequate provisions should be made for traffic devices when considering cross section and right of way requirements.

28.2 HIGHWAY CAPACITY

The existing and design year (normally 20 years from the end of the proposed construction) traffic volumes are used with the highway capacity calculations to determine the highway design based on the desired level of service. For more information on highway capacity analysis, see the *Highway Capacity Manual*. The required lane arrangement for the traffic conditions should be established through studies and in consultation with the Traffic Engineering Division.

28.3 TRAFFIC CONTROL DEVICES

Traffic control devices are essential to the safe and orderly use of highways. These devices include signs, pavement markings and signals. Effective devices should:

- fulfill a need,
- command attention,
- convey a clear and simple meaning,
- command the respect of road users,
- be located to give adequate time for response, and
- be sanctioned by law if they control or regulate traffic.

28.3.1 Manual on Uniform Traffic Control Devices

Standards for traffic control devices are described in the *Manual on Uniform Traffic Control Devices (MUTCD)*. In general, these standards are the same or similar for all classes of highways. However, high-speed facilities require special consideration with respect to the use of large messages. Higher speeds bring about increased hazards; therefore, traffic control devices must provide appropriately higher levels of warning and guidance.

The *MUTCD* information is divided into four categories — standard, guidance, option and support. These categories are used to determine the appropriate application for the various traffic control devices and are further defined as follows:

1. Standard. These are mandatory actions that are required with or without exceptions so noted under the standard heading. The *MUTCD* prints this criteria in large, bold print. Typical phrases include shall, shall mean, shall be satisfied, shall consist, etc.
2. Guidance. This category is considered to be advisory usage, recommended, but not mandatory. Deviations are allowed where engineering judgment or engineering study indicates that it is appropriate. The *MUTCD* prints these criteria in a large, normal print. Typical phrases include should, should be, should be considered, should be given, etc.
3. Option. This category includes procedures and devices that are allowed, but carry no recommendations or mandate. The user is free to use or refrain from their use. The *MUTCD* prints this information in a smaller, normal print. Typical phrases include may, may be used, may be considered, etc.
4. Support. This category includes all introductory or explanatory language. It may occur before, within or after any of the above categories. The *MUTCD* prints this information in a smaller, normal print. Typical phrases include is, are, warrants, considered, required, etc.

28.3.2 Signs

28.3.2.1 General

Signs should only be used where they are warranted by the *MUTCD*, the Department's criteria, crash history or field studies. Signs should provide information for special regulations, for hazards which are not self-evident and for highway routes, directions, destinations and points-of-interest. Generally, the road designer will not be responsible for the development of the Signing Plan Sheets and associated quantities, but will be responsible for incorporating these quantities onto the Summary of Estimated Quantities Sheet. For Interstate and other controlled access facilities the road designer should furnish the engineer responsible for signing with a set of plans as soon as the Plan and Profile Sheets are complete. For any subsequent revisions, provide the Traffic Engineering Division with the revised Plan and Profile Sheets.

The following Sections provide general guidance for the road designer on highway signing. For detailed information on highway signing, contact the Traffic Engineering Division.

28.3.2.2 Sign Application

In general, the application and placement of highway signs should follow the criteria presented in the *MUTCD* and the *SCDOT Standard Drawings*. [Figure 28.2A](#) provides general guidance for the application of various sign types.

28.3.2.3 Sign Priority

Highway signs should be erected only where they are warranted. Overloading motorists with too much information may hinder a driver's response time and impair safety. The following presents a list of the recommended priority for highway signs:

- regulatory signs (e.g., speed limit, stop signs, turn prohibitions);
- warning signs (e.g., curve signs, cross road signs, narrow bridge signs);
- guide signs (e.g., destination signs);
- emergency service signs (e.g., hospital, telephone);
- motorist service signs (e.g., fuel, food, camping);
- public transportation signs (e.g., park and ride, bus stops);
- traffic generator signs (e.g., museums, ball parks, historic buildings); and
- general information signs (e.g., county lines, city limits).

Within this priority list, the sign bearing the most important message should be retained.

Sign Type	Intended Use	Typical Uses
Regulatory	To inform users of traffic laws and regulations which apply at definite locations and at specific times.	<ul style="list-style-type: none"> • Intersection control • Designating legal right of way • Speed limits • Turning movement control • Pedestrian control • Exclusions and prohibitions • Parking control and limits • Regulations for maintenance and construction areas
Warning	To warn traffic of unusual or potentially hazardous condition(s) on or adjacent to a street or highway.	<ul style="list-style-type: none"> • Horizontal alignment • School areas • Crossings and entrances to streets, highways and Interstates • Intersections • Road construction and maintenance
Guide	To provide directional or navigational information to aid motorists in reaching their destination.	<ul style="list-style-type: none"> • Route markings • Destination • Distances
Motorist Information	To provide the user with information about facilities, services, businesses and attractions on or near the facility.	<ul style="list-style-type: none"> • Information • General services • Logo signing • Recreational and cultural signing • Tourist-orientation signing

GENERAL GUIDELINES FOR THE APPLICATION OF HIGHWAY SIGNS

Figure 28.2A

28.3.2.4 Placement

The *MUTCD* and the *SCDOT Standard Drawings* provide the Department's criteria for the placement of highway signs next to and/or over the roadway. Uniform placement of highway signing is desirable, however, not always practical. Signs should be placed at locations where they are most visible to motorists and are consistent with the highway alignment and factors effecting visibility of the signs.

Warning signs are placed in advance of the condition to which they call attention. Regulatory signs are placed where their mandate or prohibition applies or begins. Guide and informational signs are placed at varying locations to inform drivers of their route of travel, destination and points-of-interest.

When determining sign locations, the designer should review the following guidelines:

1. Special Locations. Normally, signs should be placed on the right side of the roadway. Under certain circumstances, however, signs may be placed on channelizing islands, overhead structures, on the left side of the roadway along sharp, right-hand curves, or on the left side of multilane highways.
2. Double-Indicated Signs. Double-indicated signs (i.e., on both sides of the traveled way) may be considered for additional emphasis where it is anticipated that a single sign may not provide adequate warning and where roadway geometry (e.g., multiple lanes, trucks, parked vehicles) may obscure a single sign's visibility.
3. Geometric Design. Sign placement and roadway geometric design should be coordinated as early as practical during the project planning and design stages. Road designers should make traffic engineers aware of all design exceptions. If a roadway design does not permit adequate sign placement, the geometric design may need to be revised accordingly.
4. Overhead Lane Control. Where lane control is desired, place signs directly over the affected lane.
5. Nighttime Visibility. Locate signs to optimize their nighttime visibility. Verify reflectivity requirements.
6. Field Conditions. Adherence to the criteria presented in the *MUTCD* and the *SCDOT Standard Drawings* is not always practical; sign placement may need to be adjusted to meet actual field conditions. The following presents a list of several placement problem areas that should be avoided:
 - at short sags in the roadway,
 - beyond the crest of a vertical curve,
 - where a sign would be obscured by parked cars,
 - where a sign would create an obstruction for pedestrians or bicyclists,
 - where a sign would interfere with the driver's visibility to hazardous locations or objects,
 - where the sign's visibility would be impaired due to existing overhead illumination,
 - where a sign is vulnerable to being covered by roadside splatter, and/or
 - areas too close to trees or where there is foliage that could cover the sign face.

7. Longitudinal Placement. In some cases, signs can be shifted longitudinally without compromising their intended purpose. This may improve their visibility, avoid blocking other signs, enhance safety or enhance traffic operations (e.g., by providing more distance between signs in a series).
8. Sign Groups. It may be appropriate to group the signs (e.g., route markings) with consideration for wind loading and breakaway criteria.
9. Delineators. Post-mounted delineators are optional devices used to outline the edge of the roadway and to guide motorist through critical locations (e.g., curves, turns, lane drops, narrow bridges). The color of the delineator matches the adjacent pavement stripe (i.e., white for the right side and yellow for the left side). Delineators are generally located 2 to 8 feet from the edge of the traveled way.
10. Object Markers. Object markers consist of various types or arrangements of retroreflective material placed on or next to obstructions within or near the roadway. These devices alert and/or warn users that these obstructions exist (e.g., approach end of islands or medians, bridge piers and abutments, handrails, guardrail, culvert walls).

28.3.3 Pavement Markings

28.3.3.1 General

Pavement markings must be uniform in design and location. They should convey an easily recognized and readily understood message. By adhering to this uniformity, the designer will increase operational efficiency and safety.

Pavement markings are complementary to other traffic control devices (e.g., highway signing). Under favorable conditions, they have excellent channelizing utility and convey information without diverting the driver's attention from the roadway. However, they also have the following limitations:

- their visibility is substantially reduced under adverse weather conditions;
- their visibility may be obliterated by snow and ice;
- fading, tearing and removal may occur under heavy traffic loads; and
- their message may be obscured by other vehicles.

These limitations should be considered when selecting pavement marking materials. The pavement marking materials selected should be consistent with the expected service life of the pavement.

The design of pavement markings will be consistent with the *MUTCD* and the *SCDOT Standard Drawings*. Generally, the road designer will not be responsible for the development of the Pavement Marking Plan Sheets and associated quantities, but will

be responsible for incorporating these quantities onto the Summary of Estimated Quantities Sheet. The road designer should furnish the engineer responsible for pavement markings with a set of Plans as soon as Plan and Profile Sheets are complete. For any subsequent revisions, provide the Traffic Engineering Division with the revised Plan and Profile Sheets.

The following Sections provide general guidance for the road designer on highway pavement markings. For detailed information on highway pavement markings, contact the Traffic Engineering Division.

28.3.3.2 Line Types

Pavement marking line types vary depending on their application. The following are general guidelines for permanent roadway application:

1. Color. Pavement markings shall be either white or yellow conforming to the standard highway color specifications. For example, word and symbol markings, crosswalk lines, channelization lines, stop bars, parking space lines and all lane lines will be white in color. Centerlines, no-passing barrier lines, medians and raised islands will be painted yellow.
2. Material. Where traffic volumes create a frequent need for maintenance, durable pavement markings are used. The type of material selected is dependent on surface type, location and traffic conditions. See [Section 28.3.4](#).
3. Orientation and Style. On the basis of application, line types will vary in thickness and width; will be oriented in a longitudinal, transverse or diagonal configuration; and will be striped as either single or double lines in a solid, broken or dotted pattern.

[Figure 28.3A](#) presents typical pavement markings and their general application. The *MUTCD* provides specific guidelines for the application of these markings.

28.3.3.3 Material Types

The Department is currently using several types of pavement marking materials. All pavement marking materials must meet the criteria in the *SCDOT Standard Specifications*. The application of pavement marking materials used by SCDOT is described below:

DESCRIPTION	COLOR	WIDTH (inches)	APPLICATION
Single Broken Line	White	4 (6 Interstate)	Separation of lanes on which travel is in the same direction, with crossing from one lane to the other permitted (e.g., lane lines on multilane roadways). The broken or dashed line is formed by a pattern of segments and gaps. The typical pattern is a 10-ft segment followed by a 30-ft gap for a total cycle length of 40 ft.
	Yellow	4	Separation of lanes on which travel is in opposite directions, and where overtaking with care is permitted (e.g., center line on two-lane, two-way rural roadways with a pavement width of at least 18 ft or greater). The broken or dashed line is formed by a pattern of segments and gaps. The typical pattern is a 10-ft segment followed by a 30-ft gap for a total cycle length of 40 ft.
Single Solid Line	White	4 (6 Interstate)	Separation of lanes, or of a lane and shoulder, where lane changing is discouraged (e.g., lane lines at intersection approaches, right-edge stripes). Also, lane lines separating a motor vehicle lane from a bike lane.
		8 (12 Interstate)	Delineation of locations where crossing is strongly discouraged (e.g., separation of turn lanes from through lanes, gore areas at ramp terminals, edge lines at lane drops, painted island edges).
	Yellow	4 (6 Interstate)	Delineation of left-edge lines on divided highways and ramps.
Double Solid Line	White	4-4-4*	Separation of lanes on which travel is in same direction, with crossing from one side to the other prohibited (e.g., channelization in advance of obstructions which may be passed on either side).
	Yellow	4-4-4*	Separation of lanes on which travel is in opposite directions, where overtaking is prohibited in both directions. Left-turn maneuvers across this marking are permitted. Also used in advance of obstructions which may be passed only on the right side.
Solid Line plus Broken Line	Yellow	4-4-4*	Separation of lanes on which travel is in opposite directions, where overtaking is permitted with care for traffic adjacent to the broken line, but prohibited for traffic adjacent to solid line. Used on two-way roadways with 2 or 3 lanes. Also used to delineate edges of a two-way, left-turn lane — solid lines on the outside, broken lines on the inside. The broken or dashed line is formed by a pattern of segments and gaps. The typical pattern is a 10-ft segment followed by a 30-ft gap for a total cycle length of 40 ft.

*4-4-4 indicates 4-inch lines with a 4-inch unpainted gap between them.

TYPICAL PAVEMENT LINE TYPES AND APPLICATIONS

Figure 28.3A

DESCRIPTION	COLOR	WIDTH (inches)	APPLICATION
Double Broken Line	Yellow	4-4-4*	Delineates the edges of reversible lanes. The broken or dashed line is formed by a pattern of segments and gaps. The typical pattern is a 10-ft segment followed by 30-ft gap for a total cycle length of 40 ft.
Single Dotted Line	Either	4	Extension of lane lines through intersections. Color same as that of line being extended. The broken or dashed line is formed by a pattern of segments and gaps. The typical pattern is a 2-ft segment followed by 5-ft gap for a total cycle length of 7 ft.
	White	4	Used to extend right-edge line of shoulder lanes through off-ramp diverging areas in problem locations. The broken or dashed line is formed by a pattern of segments and gaps. The typical pattern is a 2-ft segment followed by 5-ft gap for a total cycle length of 7 ft which may be adjusted to meet local site conditions.
Transverse Lines	White	8	Crosswalk edge lines minimum 6 ft apart.
		24	Limit lines or STOP bars.
Diagonal Lines	White	24	Crosshatch markings for one-way traffic, placed at an angle of 45°, 6 ft apart, on shoulders or channelization islands to add emphasis to these roadway features.
	Yellow	24	Crosshatch markings for two-way traffic, placed at an angle of 45°, 6 ft apart, on shoulders or channelization islands to add emphasis to these roadway features.
Symbols and Words	White		Specific pavement markings (e.g., arrows, only, school)

*4-4-4 indicates 4-inch lines with a 4-inch unpainted gap between them.

TYPICAL PAVEMENT LINE TYPES AND APPLICATIONS
(Continued)

Figure 28.3A

1. Paint. Fast-drying paint is typically applied as a 4-inch or wider, white or yellow stripe. Glass beads are dropped onto the wet paint, which then bond to the drying paint surface. The use of glass beads greatly enhances the retro-reflectivity of the paint stripe. Per unit cost, paint-applied markings are significantly cheaper than any other method. One of the major disadvantages of paint is that it can be quickly worn away on high-volume roadways and, therefore, often needs to be reapplied more than once a year. Consequently, paint is generally only provided as a temporary solution (e.g., in work zones).
2. Thermoplastic. Thermoplastic is typically made from hydrocarbon or alkyd resins, pigment and filler. These materials are heated to high temperatures and applied to the pavement surface. Glass beads may be included with the material or while the mixture is still hot, and may be dropped onto its surface. When the mixture cools, the glass beads then bond to the surface. Thermoplastic markings must be applied to clean, dry bituminous pavements. A primer is required on concrete bridge decks and may be required in other locations to insure satisfactory performance. Thermoplastic is significantly more expensive than paint, but often can last longer when applied properly. Due to its long life, thermoplastic is the preferred marking material for bituminous roadways.
3. Epoxy Paint. Epoxy paint is typically made from a two-component epoxy resin, pigment, extenders and fillers. The two epoxy resin components are mixed together just before application to the roadway surface. The epoxy components produce a chemical reaction that binds them together. Materials having this type of chemical reaction are called thermoset materials. Epoxy markings should be applied to clean dry pavement. Glass beads are typically dropped onto the mixture; however, they may be added by several different means depending on the epoxy material being used. Epoxy paint is generally only used on concrete pavements.
4. Preformed Pavement Markings. Preformed plastic markings are typically pre-made in a factory from vinyl, pigment and fillers and are available in strips, words or symbols. Glass beads are commonly embedded into the surface of the markings at the factory. Application of the marking typically involves removing a protective strip or applying adhesive to the pavement, laying the marking in place and applying pressure with a roller. Permanent tape may be used on both bituminous and concrete pavements. Temporary tape is commonly used in construction zones because the tape can be easily removed. However, a common problem with some temporary preformed plastic tape is that it tends to break up easily and must be routinely checked for adequacy.
5. Raised Pavement Markers. Raised pavement markers (RPM's) are typically cube-cornered acrylic or glass-bead lenses and are applied directly to the pavement with an adhesive. RPM's are designed to reflect the striping colors (i.e., white, yellow) and are used to supplement other markings and as positive

guidance devices. On Interstate routes, lane lines are supplemented with bi-directional white/red RPM's.

28.3.3.4 Pavement Markings for Bridge Plans

All bridge projects that require road plans to be developed by the road designer will include pavement markings in the Summary of Estimated Quantities Sheet. Unless the project is particularly complex, the road designer will be responsible for determining these quantities. [Chapter 35](#) presents the procedures for determining these quantities. If assistance is required, contact the Traffic Engineering Division.

28.3.4 Traffic Signals

28.3.4.1 General

A traffic signal is defined as any highway traffic device by which traffic is alternatively directed to stop and permitted to proceed. Traffic is defined as pedestrians, bicyclists, ridden or herded animals, vehicles, streetcars and any other conveyance either singularly or together while using any highway for purpose of traffic.

Traffic signals are classified as one of the following:

- traffic control signals used to regulate traffic movements and pedestrian/vehicular conflicts at intersections and special crosswalks;
- special traffic signals for warning and lane control (e.g., hazard identification beacons, speed limit sign beacons, intersection control beacons, stop sign beacons, lane-use control signals, traffic signals and gates at moveable bridges, emergency vehicle signals, ramp-control signals, bridge and tunnel signals); and
- train-approach signal and gates at highway/railroad crossings.

All traffic signal designs will meet the criteria in the *MUTCD* and the *SCDOT Traffic Signal Guidelines*. Though the road designer is not responsible for the development of the Traffic Signals Plans and the associated quantities, the road designer will be responsible for incorporating these quantities onto the Summary of Estimated Quantities Sheet.

Early coordination with the traffic engineer is required to insure that sufficient lanes and geometric design is provided at the intersection. Insure sufficient right of way is provided to allow placement of the traffic signal poles and the controller cabinet (in addition to the sight distance.)

28.3.4.2 Traffic Signal Warrants

The investigation of the need for a traffic control signal will include an analysis of the applicable factors contained in the following traffic signal warrants and other factors related to existing operation and safety at the study location. All existing signals that are impacted by a construction project should be upgraded as part of the improvement project.

Guidance on these warrants can be found in the *MUTCD* and the *SCDOT Traffic Signal Design Guidelines*. Note that the satisfaction of any of the above warrants does not in itself require the installation of a traffic signal. The signal should not be installed unless the Traffic Signal Study indicates that installing the traffic signal will improve the overall safety and operation of the intersection.

28.3.4.3 Traffic Signal Studies

A properly designed, operated and maintained traffic signal can be a valuable device for the control of vehicular and pedestrian traffic. Because it assigns right of way to various traffic movements, the traffic signal exerts a significant influence on the traffic flow and has a significant impact on vehicles and pedestrians. Consequently, it is important that the selection and use of the traffic signal be preceded by a thorough engineering study of the roadway and traffic conditions. In addition, existing traffic signals should be reviewed to insure they are still justified. Traffic Signal Studies should adequately address the following:

- geometry of the intersection;
- sight distance;
- crash history;
- traffic volumes including trucks, buses and pedestrians;
- operational observations such as delay and queuing;
- vehicular speeds;
- other signals in the area;
- driveway location; and
- character of the area.

28.3.4.4 Traffic Signal Equipment

A traffic signal installation will typically consist of the following:

1. Controller/Cabinet. The Department uses the Type 170 signal controller. This controller uses software that can be easily revised by the user. Currently, the Department is using Wapiti software; however, some signals still have the Bi-Trans software. Many municipalities and older Department installations use the

NEMA Type controller, which is more difficult and complex to use. The Department will eventually replace the NEMA installations with the Type 170 controller. Most of the Districts favor the ground-mounted controller cabinet; however, right of way availability will sometimes dictate the need for a pole-mounted cabinet. The road designer should insure there is significant right of way available at the intersection for the placement of the controller cabinet.

2. Pedestrian Heads. The Department only uses the Hand-Man pedestrian heads for all new installations and upgrades.
3. Signal Heads. The Department installs 12-inch section signal heads and is in the process of installing red and green LED's. The outside housing is highway yellow and the material is plastic.
4. Detection. The Department uses mainly inductive loop detection; however, there are some intersections operating video detection, microwave or radar type detection. Currently, inductive loops are the most cost effective option.
5. Poles. The Department uses mostly steel and concrete poles in installations especially where right of way is limited in urbanized areas, at locations subject to heavy wind loading and at very wide intersections. A Class 4 Wood Pole with back guys is still a viable option for signal poles. However, these poles are only considered if they are determined to be cost effective.

28.4 WORK ZONE TRAFFIC CONTROL

28.4.1 Purpose

Highway construction often disrupts the normal flow of traffic and may pose safety hazards to motorists, bicyclists, pedestrians and workers. Therefore, to alleviate potential operational and safety problems, SCDOT requires that work zone traffic control be considered and a traffic control plan be included on every highway construction project. The work zone traffic control plan may range in scope from very detailed design plans and Special Provisions to the incorporation of Special Provisions or merely referencing the *SCDOT Standard Drawings* and/or *Standard Specifications*. For detailed information on work zone traffic control, review the criteria in the *MUTCD*, the *Standard Drawings* and the *Standard Specifications*. Work zone traffic control practices and motorist driving patterns are constantly changing and these publications are kept as current as practical.

28.4.2 Coordination

Although typically the road designer will not be responsible for determining the type of work zone traffic control or the development of the Traffic Control Plans, the designer will be responsible for coordinating with the traffic engineer responsible for traffic control. This may consist of the following:

1. Notification. The construction sequencing and work zone traffic control should not be left until the later stages of the plan completion. This coordination should be done during the preliminary planning stage. When problems or unique situations arise in the development of a project that could affect the traffic control plan, the designer should consult with the Traffic Engineering Division.
2. Traffic Control Plans. Although the Traffic Engineering Division is responsible for the development of the Traffic Control Plans, the road designer should review the design plans to determine how they will affect the Traffic Control Plans. Some of the issues that should be considered include:
 - traffic control alternatives (e.g., phase construction, detours);
 - construction operation selection (e.g., lane closures, two-way traffic on divided highways, off-set alignments, runarounds);
 - constructability (e.g., horizontal and vertical alignment coordination, separation of work from traffic, access to work zone);
 - detour location (e.g., impacts on adjacent development, environmental impacts, utilities);
 - community impacts (e.g., schools, parks, neighborhoods, emergency services, businesses, local officials);
 - roadside safety (e.g., vehicles, work equipment, pedestrians);

- geometrics (e.g., horizontal and vertical alignment, lane drops, equipment storage);
 - accommodation of pedestrians and bicyclists (e.g., separation, lighting, temporary sidewalks, disabled); and
 - closure/detour schedule.
3. Quantities. Most traffic control items (e.g., signs, cones, barrels, barricades) required by the contractor during construction are addressed in a Special Provision entitled “Traffic Control Plans” and are accounted for in the Summary of Estimated Quantities Sheet under the pay item “Traffic Control.” The road designer will be provided with the necessary quantities and incorporate them onto the Summary of Estimated Quantities Sheet.
4. Impact Attenuators. Where necessary, include a Test Level 3–70 miles per hour construction (work) zone portable impact attenuator terminal on all Interstate projects and non-Interstate facilities with speed limits posted for 65 mile per hour or more. Test Level 3–60 miles per hour units may be used on non-Interstate routes where the posted speed limit is 60 miles per hour or less. Use the permanent posted speed limit in place prior to construction.

28.5 INTELLIGENT TRANSPORTATION SYSTEMS (ITS)

These systems include the latest transportation technologies and are designated to provide South Carolina with maximum road-use efficiency.

28.6 RAILROAD CROSSINGS

The Rail Grade Crossing Program is designed to identify highway-rail at-grade crossings for upgrades. Crossings are prioritized based upon an index that is calculated using a method developed by the Federal Highway Administration and Federal Railroad Administration. Various factors are considered in this process (e.g., train speed, train and traffic volumes, existing warning devices at the crossing, number of tracks, crossing alignment, sight distance, school bus activity, crash history).

28.7 HIGHWAY LIGHTING

Providing lighting for all highway facilities is neither practical nor cost effective. It is generally SCDOT's practice to only provide highway lighting where justified based on sound engineering judgment. The Department will assess the economic feasibility of lighting projects and identify candidate locations. A location that appears to justify lighting does not necessarily obligate the Department to provide funding. Local agencies may provide lighting within their respective jurisdictions provided they find sufficient benefit in the forms of convenience, safety, policing, community promotion, public relations, etc., and participate in an appreciable percentage of the cost, or wholly finance, the installation, maintenance and operation of the lighting facilities. The impacts of local conditions (e.g., frequent fog, ice, roadway geometry, ambient lighting, sight distance, signing) also should be considered when analyzing highway lighting needs. For additional guidance on highway lighting, contact the Traffic Engineering Division.

The road designer is typically not responsible for the development of the Highway Lighting Plans and the associated quantities though the road designer will be responsible for incorporating these quantities onto the Summary of Estimated Quantities Sheet.

The design of a highway lighting system will meet the criteria in the latest approved edition of the AASHTO publication, *An Informational Guide to Roadway Lighting*.

28.8 TRAFFIC CALMING

Traffic calming, also known as neighborhood traffic control, traffic restraint, local-area traffic management and environmental management, is a method to physically and visually impede speeding and the use of local roads by non-residents. This technique involves the provision of innovative traffic control devices, which when properly designed and situated can achieve reductions in traffic speed and non-local traffic volumes. Traffic calming measures may include changes in street alignment, installation of barriers and other physical measures. Traffic calming is typically best applied only on neighborhood streets where reduced vehicular speeds will improve the street safety, livability and other public purposes.

For guidance on the traffic calming, see the *SCDOT Traffic Calming Manual*.

28.9 REFERENCES

1. *Manual on Uniform Traffic Control Devices, Millennium Edition*, ATSSA, ASSHTO, ITE and FHWA, 2001.
2. *Traffic Control Devices Handbook*, ITE, 2001.
3. *Traffic Signing Handbook*, ITE, 1997.
4. *SCDOT Traffic Signal Design Guidelines*, SCDOT, 2002.
5. *South Carolina Advance Work Zone Safety Guidelines*, Institute for Transportation Research and Education, North Carolina State University, 1993.
6. *An Informational Guide to Roadway Lighting*, AASHTO, 1984.
7. RP-8-00, *American National Standard Practice for Roadway Lighting*, ANSI/IESNA, 2000.
8. *Traffic Calming Manual*, SCDOT, 2001.
9. *Traffic Calming: State of the Practice*, ITE and FHWA, 1999.

Table of Contents

<u>Section</u>	<u>Page</u>
29.1 DEFINITIONS.....	29.1(1)
29.2 PROCEDURES	29.2(1)
29.2.1 Division of Responsibilities	29.2(1)
29.2.1.1 Culverts	29.2(1)
29.2.1.2 Storm Drainage	29.2(1)
29.2.1.3 Roadside Ditches	29.2(3)
29.2.1.4 Curb Ramps	29.2(3)
29.2.2 Drainage Design.....	29.2(4)
29.2.3 NPDES	29.2(4)
29.3 ROADWAY DRAINAGE CRITERIA.....	29.3(1)
29.3.1 General.....	29.3(1)
29.3.2 Inlet Spacing.....	29.3(1)
29.3.3 Sideline Pipes.....	29.3(2)
29.3.4 Crossline Pipes.....	29.3(2)
29.3.5 Asphalt Gutters.....	29.3(2)
29.3.6 Box Culvert Extensions	29.3(2)
29.3.7 Drainage for Bridge Ends	29.3(3)
29.3.8 Trench Drains.....	29.3(3)
29.4 REFERENCES.....	29.4(1)

Chapter Twenty-nine

ROADWAY DRAINAGE

Proper roadway drainage is a critical element in protecting the structural integrity of the highway system, insuring the safety of the traveling public and avoiding adverse impacts on adjacent property. A significant portion of highway construction funds are expended on drainage-related items. This Chapter provides definitions related to roadway drainage and a brief overview of the Department's internal procedures on drainage and selected criteria for drainage appurtenances. The *SCDOT Requirements for Hydraulic Design Studies* provides a comprehensive discussion on the Department's hydrologic and hydraulic practices. This publication can be found on the Internet at the following Internet address <http://www.dot.state.sc.us/doing/pdfs/requirements.pdf>.

29.1 DEFINITIONS

The following presents selected definitions that have an application to roadway drainage:

1. 100-Year Flood. A flood volume (or discharge) level that has a 1 percent chance of being equaled or exceeded in any given year.
2. Allowable Headwater Depth. The depth or elevation of the flow impoundment for a drainage facility (e.g., a culvert) above which damage or a significant flood hazard could occur.
3. Backwater. The increase in water surface elevation relative to the elevation occurring under natural channel and floodplain conditions (upstream of a highway facility).
4. Base Flood. The design flood used for hydrologic calculations that are based on the roadway classification.
5. Base Floodplain. The area subject to flooding by the base flood.
6. Channel Change. A modification to the natural alignment of a channel (stream) necessitated by highway construction. Channel changes should only be used where absolutely essential (e.g., where the natural channel will be covered in fill).
7. Culvert. A structure that is a) usually a closed conduit designed hydraulically to take advantage of submergence to increase hydraulic capacity, and b) used to convey surface runoff through a highway or railroad embankment. AASHTO classifies a culvert as a structure of less than a 20-foot span as measured along the roadway centerline. A culvert is a structure, as distinguished from a bridge,

- that is usually covered with embankment and is composed of structural material around the entire perimeter.
8. Design Flood Frequency. The flood frequency selected for determining the necessary size of the drainage appurtenance.
 9. Detention Pond. A basin, pond or reservoir incorporated into the watershed where runoff is temporarily stored, thus attenuating the peak of the runoff hydrograph. A stormwater management facility that temporarily impounds runoff and discharges it through a hydraulic outlet structure to a downstream conveyance system.
 10. Ditch Check Dam. A small temporary dam constructed across a swale or drainage ditch that acts as a filter trapping soil particles and allowing water to flow through. See *SCDOT Standard Drawings*.
 11. Drainage Area. The catchment area for rainfall and other forms of precipitation that is delineated as the watershed producing runoff (i.e., the contributing watershed.)
 12. Drainage End Treatment. A structure, commonly made of concrete or metal, that is attached to the end of a culvert or pipe for such purposes as retaining the embankment from spilling into the waterway, improving the appearance, providing anchorage, improving the culvert efficiency and/or limiting some scour at the outlet.
 13. Erosion Control. Mitigation measures used to reduce (or decelerate) erosion, which is a natural or geologic process whereby soil materials are detached and transported from one location and deposited elsewhere, primarily due to rainfall, runoff and wind.
 14. Flood Frequency. The number of times a flood of a given magnitude can be expected to occur on average over a specified period of time.
 15. Floodplain. Any plain that borders a stream and is covered by its waters in time of flood. A nearly flat, alluvial lowland bordering a stream and commonly formed by stream processes that is subject to inundation by floods.
 16. Headwater Depth. Depth of water above the inlet flow line at the entrance of a culvert or similar structure. Depth of water upstream of a contraction such as occurs at a bridge or similar structure. Natural flow depth plus backwater caused by a drainage structure.
 17. Hydrology. The science that explores the interrelationship between water on the earth and in the atmosphere. In hydraulic practice for highways, hydrology is used to calculate discharges for a given site based on the site characteristics.

18. Intensity. The rate of rainfall upon a watershed, usually expressed in inches per hour.
19. Maximum Allowable Backwater. The maximum amount of backwater that is acceptable to the Department for a proposed facility based on State and Federal laws and on Department policies.
20. Outfall Ditch. A channel that directs stormwater discharge from a roadway facility.
21. Peak Discharge (Peak Flow). The maximum rate of flow passing a given point during or after a rainfall event or snow melt. For example, the peak discharge for a 100-year flood is expressed as Q_{100} .
22. Recurrence Interval (Return Period). The average number of years between occurrences of a discharge of a particular magnitude. For example, the recurrence interval for a 100-year flood discharge is 100 years.
23. Regulated Floodway. The floodplain area that is reserved in an open manner by Federal, State or local requirements (i.e., unconfined or unobstructed either horizontally or vertically) to provide for the discharge of the base flood so that the cumulative increase in water surface elevation is no more than a designated amount as established by the Federal Emergency Management Agency (FEMA) for administering the National Flood Insurance Program (NFIP).
24. Retention Pond. A basin, pond or reservoir where water is stored for regulating a flood. The stored runoff is disposed of by such means as infiltration, by injection (or dry) wells or by release to the downstream drainage system after the storm event. The release may be through a gate-controlled gravity system or by pumping.
25. Routed Flow. The process whereby a peak flow and/or its associated streamflow hydrograph is mathematically transposed to another site downstream considering the effect of channel storage.
26. Runoff Coefficient. A factor, dependent on terrain and topography, representing that portion of runoff that results from a unit of rainfall. More simply stated, the rate of runoff to precipitation.
27. Silt (or Sedimentation) Basin. A storage area, either temporary or permanent, used to detain sediment-laden runoff from disturbed areas for a sufficient length of time for the majority of the sediment to settle.
28. Spread. The transverse encroachment of stormwater onto a street where flow has accumulated in and next to the roadway gutter. This water may represent an interruption to traffic flow, splash-related problems and a source of hydroplaning during rainstorms.

29. Trench Drain. A long, narrow drainage inlet that extends for a considerable length to intercept flow before exiting onto a roadway or to collect gutter flow to reduce ponding depth and spread at curb inlets. See [Section 29.3.8](#).
30. Velocity. The rate of travel of a stream or river or of the objects or particles transported therein, usually expressed in distance per unit time.

29.2 PROCEDURES

29.2.1 Division of Responsibilities

The Hydraulic Engineering Section is responsible for performing and/or reviewing hydrologic and hydraulic analyses on all Federal-aid projects, and others by request, for both roadway drainage appurtenances and bridge waterway openings. The road designer will calculate all quantities pertaining to drainage appurtenances and bridge waterway openings. The responsibilities of the Road Design Section and Hydraulic Engineering Section are discussed in the following Sections.

29.2.1.1 Culverts

For all box culverts and all pipe culverts with diameters greater than 24 inches, the Hydraulic Engineering Section will perform all work on the culvert hydraulic design. This includes the:

- hydrologic analysis to calculate the design flow rate based on the drainage basin characteristics;
- hydraulic analysis to select the culvert dimensions and layout (e.g., longitudinal gradient, invert elevations);
- selection of culvert material (e.g., reinforced concrete, corrugated metal);
- erosion control revetment; and
- end treatments (e.g., energy dissipators).

The Roadway Structures Design Group is responsible for the structural/service-life designs of culverts.

On projects where the Hydraulic Engineering Section does not perform the analyses, existing 24-inch and smaller pipes may be judged to be adequate during the Design Field Review based on input from District personnel that the pipes have performed adequately.

29.2.1.2 Storm Drainage

The road designer will present the proposed roadway design to the Hydraulic Engineering Section. The information required from the Road Design Section prior to the Hydraulic Engineering Section beginning its storm sewer design using GEOPAK Drainage is as follows:

1. Hard Copy.
 - a. Cross Sections to scale on half-size sheets:
 - mainline (including top of curb grades),
 - side roads, and
 - outfall ditches.
 - b. Plan Sheets to scale on half-size sheets:
 - centerline final grades for mainline,
 - final grades for side roads,
 - all outfall ditch surveys and profiles,
 - limits of construction line, and
 - all existing survey pipe recommendations.
2. Electronic Copy.
 - a. Project Coordinate Geometry (Project.gpk);
 - b. Project Design File (Project pp.dgn);
 - c. Project Sheet File (Project pf.dgn);
 - d. Project Survey File (Project.new);
 - e. Project Station Offset File (Drainage Report File from SOA);
 - f. list of names for centerline and top-of-curb PGL's, and names and locations of all other file names and requested information emailed to Hydraulic Engineering Squad Leader; and
 - g. most accurate curb grades:
 - prior to Design Field Review, curb grades will be preliminary, and
 - shortly after Design Field Review, curb grades will be final.

The following information will be required from the Hydraulic Engineering Section for the Road Design Section to finalize the plans with reference to hydraulic information:

1. Hard Copy.
 - a. Plan Sheets stating which existing pipes will be abandoned or retained.
2. Electronic Copy.
 - a. Geopak Drainage File (Project.gdf),
 - b. Drainage Library File (Project.dlb),
 - c. Summary Report from GEOPAK Drainage listing information pertinent to Road Design, and

- d. List of file locations and file names of requested information emailed to Road Design Group Leader.

All information will be transferred electronically by both the Road Design Section and the Hydraulic Engineering Section by connecting network drives between the parties involved, unless specified differently above.

The Road Design Section will notify the Hydraulic Engineering Squad Leader if there are any changes to the top-of-curb elevations, road templates, horizontal or vertical alignments, shape files or typical sections. In addition, notify the Squad Leader if alternative pipe materials will be used.

Based on this information, the Hydraulic Engineering Section is responsible for all work related to the design of a drainage system. This includes:

- flow calculations in the system,
- pipe size and material,
- spacing of inlets,
- pipe slopes and invert elevations,
- outfall location and design, and
- erosion control and revetment.

The road designer will confirm the exact location of inlets to insure that the inlets are located at low spots and to avoid conflicts with utilities, curb ramps, etc. The road designer will perform the drafting and labeling appropriately for all storm drain facilities.

29.2.1.3 Roadside Ditches

The road designer determines the dimensions of the roadside ditch based on the criteria presented in [Chapters 13 and 19 through 22](#) of the *SCDOT Highway Design Manual*. Typically, no analysis is performed to determine hydraulic capacity. However, where determined necessary, the Hydraulic Engineering Section will evaluate the ditch and the potential for erosion and, if needed, recommend a ditch size and a permanent protective ditch lining.

29.2.1.4 Curb Ramps

To meet the requirements of the *Americans with Disabilities Act*, a project may require the installation of curb ramps that may, in turn, interfere with an existing curb inlet. In this case, the road designer and the Hydraulic Engineering Section will work together to resolve the conflict.

29.2.2 Drainage Design

The following procedure is used for the development of the preliminary roadway surface drainage and the selection of the location and spacing for curb inlets:

1. When the Road Design Section has prepared plans from the survey data, a Design Field Review will locate outfalls. A separate drainage field review may be made at the discretion of the Hydraulic Engineering Section.
2. Following the Design Field Review, the Hydraulic Engineering Section will complete the design of the drainage system.
3. When the design is complete, the Hydraulic Engineering Section may schedule a review of the drainage design. Participants at the review may include representatives from the Program Development Section, District Office, Construction/Maintenance Division, Road Design Section and/or Hydraulic Engineering Section.
4. If there is a review, the Hydraulic Design Engineer will make any necessary adjustments to the design and furnish the details of the design to the Road Design Section for inclusion in the Plans.

29.2.3 NPDES

As a result of the *National Environmental Policy Act* of 1969, much attention has been directed to the control of erosion and sedimentation. Therefore, numerous State and Federal regulations and controls governing land disturbing activities have been promulgated. This includes the permitting requirements of Section 402 of the *Federal Water Pollution Control Act* (FWPCA), known as the National Pollutant Discharge Elimination System (NPDES) permit. The NPDES authorized under 40 CFR 122.26(b)(14)(x) addresses storm water discharge from construction sites. In 1990, the Phase I regulations were applied to construction activities that disturb more than 5 acres. A subsequent signing of the Phase II Final Rule addresses disturbed areas between 1 and 5 acres.

A NPDES permit requires a Stormwater Pollution Prevention Plan for industrial activities (including construction) for undisturbed areas of 1 acre or more. For those States that do not operate under delegated authority for sediment and erosion control, a Notice of Intent (NOI) is required. The NOI is a USEPA, NPDES form titled "Notice of Intent (NOI) for Storm Water Discharges Associated with CONSTRUCTION ACTIVITY Under a NPDES General Permit."

The South Carolina Department of Health and Environmental Control (SCDHEC) administers the NPDES Program in South Carolina on behalf of the US Environmental Protection Agency. SCDOT has a General Permit with SCDHEC for NPDES applications, which is in effect for five years. No individual permits are necessary.

[Section 30.3.3](#) discusses NPDES with respect to right of way impacts. The designer should also review this information.

29.3 ROADWAY DRAINAGE CRITERIA

The *SCDOT Requirements for Hydraulic Design Studies* and the *Road Design Plan Preparation Guide* document the Department's hydrologic and hydraulic criteria for the design of roadway drainage appurtenances. This Section presents a few details of special interest to the road designer.

29.3.1 General

Most highway projects require new drainage facilities and/or the improvement of existing drainage systems. This may be in the form of earth or lined, channels, streams, culverts, closed drainage systems, etc. A specific project may incorporate any or all of these drainage requirements. The road designer must be knowledgeable of Department drainage policies and practices affecting road design elements.

29.3.2 Inlet Spacing

Inlets are required at locations needed to collect runoff to meet the design controls specified by the Department's design criteria (e.g., allowable water spread, design year). In addition, there are many locations where inlets may be necessary without regard to contributing drainage area. These locations should be marked on the Plans prior to any computations of discharge, water spread, inlet capacity or bypass. Examples of these locations are as follows:

1. Place inlets at low points (e.g., sags) and at intersections as required to intercept the flow.
2. Unless a hydraulic analysis indicates otherwise, inlet spacing should be based on the inlet spacing charts. These charts can be found at <http://iwww.dot.state.sc.us/hydrology/references.htm>.
3. Place inlets upstream of median breaks, entrance/exit ramp gores, crosswalks and cross slope transitions.
4. Place inlets immediately upstream and downstream of bridges.
5. Re-space inlets following the field review, if required.
6. Methods may be used to supplement catch basins and expand the efficiency and capacity of drainage (e.g., trench drains or extended throats).

29.3.3 Sideline Pipes

Sideline pipes are identified as longitudinal pipe culverts in roadway ditches at driveways and other locations. The policy for establishing pipe lengths for standard drives is as follows:

1. Provide a minimum length of 24 feet of pipe at each standard 12-foot drive.
2. Additional pipe (of various sizes) may be shown in the Plans as an inclusion item (to be determined during the Design Field Review).
3. If additional (or less) pipe length is required at driveways during construction, the Resident Construction Engineer will make these determinations.

29.3.4 Crossline Pipes

In calculating the length of pipe required to span the fill wherein beveled or flared end sections will be used, give consideration to the usable length of a beveled or flared end section.

For the use of pipe end structures with respect to roadside safety, see [Section 14.4](#).

29.3.5 Asphalt Gutters

Use Figure 29.3A to determine the limits of asphalt gutters.

Gutter Design Grade	Distance to Carry Surface Runoff Before Beginning Asphalt Gutter
0 to 0.5%	None Required
>0.5% to 1.00%	1,000 linear feet
>1.00% to 2.00%	500 linear feet
Over 2.00%	250 linear feet

ASPHALT GUTTER
Figure 29.3A

29.3.6 Box Culvert Extensions

A desired space of 10 feet should be provided between the wingwall ends of box culvert extensions and the present or new right of way. Additional right of way should be provided as required at each site, to encompass permanent erosion control devices (e.g., energy dissipators, paved liners) placed at the ends of box culvert extensions.

In some cases, the road designer may design large junction boxes for box culverts.

29.3.7 Drainage for Bridge Ends

The designer will use “Concrete Transition Curb and Flume at Bridge Ends” with a paved shoulder area on all bridge ends, except where “Bridge Concrete Curb and Gutter with Flume” is provided in the Bridge Plans. “Bridge Concrete Curb and Gutter with Flumes” will be used on the left and right side at the low end of the bridge when the longitudinal grade is ≥ 1 percent at the low end of the bridge.

“Concrete Transition Curb and Flume” will be placed on all bridge ends where the Bridge Plans do not show the “Bridge Concrete Curb and Gutter with Flumes.” On the high side of superelevated sections, only the concrete transition curbs and paved shoulder areas will be constructed. The flume and riprap will not be placed on the high side of superelevated sections.

When the bridge end drainage is provided by the Road Design Section, use *Standard Drawing* No. 721-1 to determine the pay items and quantities needed. Be aware of the two types of bridge ends (i.e., with and without a bridge approach slab). In addition, three linear feet of 9-inch by 15-inch concrete curb for each corner of the bridge using the concrete transition curb should be placed in the inclusions to be used as determined by the engineer.

Where practical, avoid zero gradients and low points for sag vertical curves on all bridges. It is desirable to keep the low point within 50 feet of the bridge end. If zero gradients and low points on bridges are unavoidable, the design should be discussed with the appropriate Assistant Bridge Design Engineer.

29.3.8 Trench Drains

Trench drains should be considered where surface flows are suspected to interfere with traffic operations. Runoff from an adjacent property through a driveway toward the roadway can be intercepted by a trench drain, installed across the driveway, and conveyed into the parallel ditch or into a drainage box. In this case, the “Trench Drain – 8” Interior Dimension (Driveway Application)” may be used.

In curb-and-gutter sections, the typical section provides for runoff to reach the gutter. However, when rehabilitating and widening a section of roadway that was previously a ditch section but is now being designed as a curb-and-gutter section, grades, vertical curves and superelevation rotation can prohibit conveying the runoff to the desired catch basins and storm sewers. Typically, the minimum desired gutter grade is 0.5 percent; however, 0.3 percent may be used with adequate cross slope. The length of curve can create relatively flat locations on a crest and in a sag vertical curve. Where feasible, catch basin spacing may be reduced to facilitate the efficiency of the drainage system.

Where additional pipe and catch basins are not feasible or the area is not conducive to a catch basin, such as in a driveway, then trench drains may be installed in the gutters to enhance the roadway drainage. Trench drains in gutters will reduce potential ponding in the gutter area caused by inherent, nearly flat grades occurring in pavement transitions and in the low and high points of vertical curves. Typically, the flow line of a trench drain is fixed at 0.6 percent but will vary according to the grade of the gutter. Trench drains can be placed in an opposing direction to the gutter grade, if the gutter grade does not exceed 0.2 percent in the opposite direction. For example, this would yield a trench drain flow line grade of 0.4 percent in a gutter with an opposing grade of 0.2 percent. This composite grade of the trench drain flow line should not be less than 0.4 percent.

Consider the following guidelines where trench drains are used to supplement drainage in gutters:

- Where calculated individual longitudinal grades in the gutter are ≤ 0.1 percent. Actual elevations on profile must be checked to determine percent grade in vertical curves.
- Drainage box within 96 linear feet to outlet the trench drain.
- Trench drain must be designed in 16-foot increments. The maximum length of trench drain in one run is 96 linear feet.
- Place location and quantity information on the "General Construction Note" Sheet.

Quantities for trench drain and curb and gutter will not overlap. Where trench drain is extended through a driveway in the gutter, measurement of the trench drain will be made only where the curb and gutter normally is measured. This is typically in drives where the curb drops to the gutter elevation and does not turn away from the roadway on a radius to follow the edge of the driveway. For a driveway where the curb follows a radius away from the roadway, and the trench drain extends into or through the driveway, then the trench drain that is not in the curb and gutter will be measured and paid for as "Trench Drain (Driveway)." The width of the trench drain, including the standard concrete width for the drain, will be deducted from the area measurement for concrete driveway.

29.4 REFERENCES

1. *Model Drainage Manual*, AASHTO, 2003.
2. *Requirements for Hydraulic Design Studies*, SCDOT, May 2000.

Table of Contents

<u>Section</u>	<u>Page</u>
30.1 INTRODUCTION.....	30.1(1)
30.1.1 Right of Way Related Laws	30.1(1)
30.1.2 Advantages of Adequate Right of Way.....	30.1(2)
30.1.3 Future Improvements	30.1(3)
30.2 PRELIMINARY ACTIVITIES	30.2(1)
30.2.1 Design Field Reviews	30.2(1)
30.2.2 Public Hearing Process	30.2(1)
30.2.3 Environmental Studies.....	30.2(1)
30.3 RIGHT OF WAY IN DESIGN.....	30.3(1)
30.3.1 Present Right of Way.....	30.3(1)
30.3.2 Right of Way Widths	30.3(1)
30.3.3 National Pollutant Discharge Elimination System (NPDES)	30.3(2)
30.3.3.1 Determining NPDES Needs	30.3(2)
30.3.3.2 NPDES Quantities and Bid Items	30.3(2)
30.3.3.3 Setting the Location of Right of Way Lines in NPDES Areas.....	30.3(2)
30.3.3.4 Coordination of Hydrology/NPDES Studies with the Right of Way Office	30.3(4)
30.3.4 Construction Limits	30.3(4)
30.3.5 Breaks In Rights-of-Way.....	30.3(5)
30.3.6 Control of Access	30.3(5)
30.3.7 Triangular Areas.....	30.3(6)
30.3.8 Traffic Control Devices	30.3(6)
30.3.9 Outfall/Infall Ditches.....	30.3(6)
30.3.10 Channel Changes.....	30.3(7)
30.3.11 Culvert Sites	30.3(7)
30.3.12 Bridge Sites	30.3(7)
30.3.13 Bridge Construction Access	30.3(7)
30.3.14 Energy Dissipaters	30.3(8)
30.4 ELEMENTS OF RIGHT OF WAY.....	30.4(1)
30.4.1 Present Right of Way.....	30.4(1)
30.4.2 New Right of Way.....	30.4(1)

Table of Contents

(Continued)

<u>Section</u>	<u>Page</u>
30.4.3 Right of Way Markers	30.4(1)
30.4.4 Property Information	30.4(2)
30.4.5 Identification of Property Features and Improvements	30.4(2)
30.4.6 Property Purchase vs. Easements	30.4(3)
30.4.7 Condemned Parcels	30.4(3)
30.4.8 Dedicated Right of Way.....	30.4(3)
30.4.9 Property Closures.....	30.4(3)
30.4.10 Encroachments	30.4(4)
30.4.11 Land Locked Parcels	30.4(4)
30.4.12 Federal Government Properties	30.4(4)
30.4.13 Right of Way Deeds/Easements.....	30.4(5)
30.4.13.1 Deed Descriptions	30.4(5)
30.4.13.2 Permanent Easements (Outside the Right of Way) ..	30.4(5)
30.4.13.3 Temporary Construction Easements	30.4(6)
30.4.13.4 Property Records.....	30.4(6)
30.4.14 Special Features	30.4(6)
30.4.14.1 Retaining Walls.....	30.4(6)
30.4.14.2 Cemeteries	30.4(7)
30.4.14.3 4(f) and 6(f) Lands	30.4(7)
30.5 REFERENCES.....	30.5(1)

Chapter Thirty

RIGHT OF WAY

30.1 INTRODUCTION

The purpose of this Chapter is to provide an overall understanding of right of way elements and their impact on the design of roadway projects. This information will provide the designer with an overview of SCDOT policies and procedures relative to right of way. This Chapter will allow right of way issues to be properly addressed during design and right of way information to be completely documented on the Right of Way Plans. Specific information, relative to the provisions of right of way, is contained in the Department's *Right of Way Manual*.

The term Right of Way Plans refers to the stage at which Roadway and Bridge Plans are adequately developed for the acquisition of right of way. This occurs at approximately the 70 percent complete design stage and includes, at a minimum, an accurate representation of existing topographic and property features and all items that affect the final establishment of new right of way limits. Sufficient drainage design should also be included to show the extent of all ditch work

As part of the right of way process, it is required that:

- On Federal-aid projects final environmental document and preliminary design approvals must be received prior to submission of a request for right of way authorization approval.
- Right of Way Plans must be approved and signed prior to commencement of right of way purchases.
- All rights of way for Federal-aid projects should be acquired prior to advertisement for construction bidding (see the Department's *Right of Way Manual* for guidance).

30.1.1 Right of Way Related Laws

SCDOT may acquire an easement or fee simple title to real property by gift, purchase or condemnation for the construction, maintenance, improvement or safe operation of roadways. The acquisition of right of way, whether in easement or fee simple title, is provided for by both Federal and State law.

The Federal law that allows the Department to acquire right of way for Federal-aid assisted projects is the *Uniform Relocation Assistance and Real Property Acquisition*

Policies Act of 1970 (Public Law 91-646), as amended. The State laws, which empower the Department to acquire right of way for both Federal-aid assisted and totally State funded projects, are found in Titles 57 and 28 of *South Carolina Code of Laws*, as amended.

South Carolina State law provides that SCDOT comply with all applicable Federal laws, and regulations to obtain the use of Federal funds for the benefit of the public. Both State and Federal law provide that a landowner has the right to “just compensation.” “Just compensation” includes the value of the land acquired plus the added value for damages to any remaining land minus the accrued value for benefits to the remaining land. The appraisal must be made available to the landowner. A landowner may waive the right to an appraisal and may donate the land for the Department’s use. The Right of Way Office will document these waivers.

If a landowner, or other person holding an interest in the property who qualifies as a displacee, there are additional payments and services available under the Relocation Assistance Program. Both residential and business tenants may also qualify for relocation assistance payments and services if they are in occupancy of real property for the requisite length of time and will be displaced. Relocation assistance payments for replacement housing and moving costs are conditional payments determined by the Department’s Right of Way Office. Moving costs are available to both residential and business or nonprofit organizations that qualify as displacees.

The Department must provide the payment of “just compensation” to the landowner and relocate all displacees or must obtain a “right-of-entry agreement,” before it has the right to enter for construction purposes. On Federal-aid projects, the Federal Highway Administration will not authorize construction until the Department’s Director of Rights of Way certifies that all required right of way has been acquired in accordance with Federal laws and regulations and that all displacees have been relocated.

30.1.2 Advantages of Adequate Right of Way

The new right of way boundaries represent the limits of usable area required for the construction of the roadway, its appurtenant structures and for maintenance activities following construction. It is therefore important that the total area be as generous as practical keeping in mind during the decision making process the economic impacts to the overall project costs and the benefits derived.

In rural areas, maintenance activities (e.g., mowing, ditch and channel cleanout, shoulder repairs) are more easily accomplished within an adequate working area. Additionally, these areas may provide space for placement of utilities and traffic control devices. An important reason for providing a wide right of way is to effect adequate clear zones and to provide sufficient sight distance at intersections and around curves. In general, the preliminary right of way limits should be established a sufficient distance

outside the construction limits to accommodate future maintenance activities and adjusted to tighter limits as significant conflicts dictate. The new right of way limits should be adjusted for uniformity and to eliminate transition lines, to achieve a uniform offset from the survey centerline for extended lengths, as much as practical. These considerations are generally not applicable in urban areas due to high property costs and because property owners often maintain grounds adjacent to, and often within, the right of way.

30.1.3 Future Improvements

It may be desirable at times to “plan for the future” in the preliminary and final roadway design stages. Sufficient data may be available which leads to the conclusion that certain improvements should be performed initially and other improvements delayed to the future. It is generally safe to assume that land values will increase with time. In an effort to reduce overall project costs, additional lands for right of way purposes may be set aside to accommodate future improvements. Therefore, the designer must consider such features as additional lanes, divided roadways, future interchanges, etc., and design for these future improvements to establish the right of way requirements. Accurate documentation of future planned elements must be incorporated into the Plans to support the established right of way boundaries.

30.2 PRELIMINARY ACTIVITIES

During the preliminary plans development stages, it is essential to work closely with Right of Way personnel. Their knowledge of right of way and property matters can be invaluable during the early stages of project development and may help the designer avoid uneconomical decisions and plan modifications.

30.2.1 Design Field Reviews

On all projects, provide the Right of Way Office with the Design Field Review Plans prior to the field review. Generally a Right of Way representative will be present at the Design Field Review. The option to review the Plans and determine the necessity for the presence of the Right of Way representative, at any particular review, will remain at the discretion of the Director of Rights of Way.

30.2.2 Public Hearing Process

The Department holds public hearings on certain projects. Both location and design public hearings may be required for projects on new location. A single combination location-design hearing may be required for projects along existing locations.

At these hearings, the Right of Way Office is responsible for providing a representative to discuss the right of way acquisition procedure, outline the relocation assistance program, and answer any questions concerning appraisals, acquisition and relocation assistance. The brochure, entitled *Highways and You*, outlining the public hearing process, as well as the Relocation Assistance Services, is also to be made available to the public at these hearings.

30.2.3 Environmental Studies

In the development of a highway project, the Environmental Management Office prepares environmental studies in the form of environmental impact statements or environmental assessments. The Right of Way Office is required to furnish the information required in the FHWA Technical Advisory T6640.8A to the Environmental Management Office.

30.3 RIGHT OF WAY IN DESIGN

It is important that the designer be familiar with the rules and policies for establishing and depicting right of way and related data on the plans. Consistency in this area permits easier reviews by Right of Way personnel and aids the appraisal process and preparation of instruments of record.

30.3.1 Present Right of Way

Present right of way will be documented by the SCDOT Right of Way Office and shown on the Plans. This will take place when the Road Design Group plots the plans from the survey data.

In cases where enclosed property is offset from verified present right of way, SCDOT claims only to the present right of way line and not to the property line.

In cases where no present right of way exists and property is shown using property pins, SCDOT then claims to the existing property line, edge of pavement or ditch line as determined through research. This is labeled as new right of way. In all cases, tax map information must be shown. For more information on how right of way lines are shown on the Plans, see the *Road Design Plan Preparation Guide*.

30.3.2 Right of Way Widths

New right of way boundaries may be of uniform widths, varying widths or a combination thereof. If there appears to be enough uniformity throughout the project limits, it is desirable to establish a uniform width and apply it to the design throughout. Any work required outside the uniform width may be accomplished by obtaining the property owner's permission. This procedure will allow the construction to take place outside of the right of way and when construction activity is completed, the Department has no further rights or obligations.

Determining the width of the permanent right of way is primarily a function of the typical section, along with safety and drainage requirements for a section of roadway. Although these are the prevailing criteria to set right of way, an additional criteria has emerged, which is based on the requirements of the National Pollutant Discharge Elimination System (NPDES). The new right of way limits should be evaluated in the field.

30.3.3 National Pollutant Discharge Elimination System (NPDES)

30.3.3.1 Determining NPDES Needs

Areas determined necessary due to NPDES for the construction and maintenance of erosion control items during construction may require additional right of way. All NPDES areas to be maintained after completion of a project are to be secured by permanent right of way. Permanent right of way should also be used around all sediment control basins (temporary and permanent); but all other temporary NPDES facilities will be covered by permission. If permission cannot be obtained, then the area will be acquired as right of way. In both instances, the area will be cleared and grubbed and seeded during construction.

Where additional right of way is more difficult to obtain due to high cost, urban areas, wetlands and/or significant trees, consider all means to circumvent these conflicts by minimizing the need for additional right of way, while still allowing implementation and maintenance of necessary erosion control facilities.

30.3.3.2 NPDES Quantities and Bid Items

Temporary NPDES facilities installed by permission will be seeded, according to the temporary seeding schedule, at the time of installation. The permanent seeding schedule should be used after the temporary NPDES facility has been removed and the area reclaimed. Permanent NPDES facilities will be seeded according to the normal seeding schedule. All seeding will be completed and paid for in accordance with the *Standard Specifications for Highway Construction*.

If the area required for NPDES is to be reclaimed, then include the quantity of soil for re-grading in the total quantity of "Silt Basins" and show the necessary seeding in the Plans. Where it is necessary to reclaim the area in which a "Temporary Sediment Control Structure and Basin" is located, the structure and appurtenances, all riprap associated with that basin, pipe connected to the structure, anti-seep collars, and the fence and gate surrounding the basin are to be removed and disposed of in the bid item for "Temporary Sediment Control Structure."

30.3.3.3 Setting the Location of Right of Way Lines in NPDES Areas

For all fill slopes, provide a silt fence in order to minimize the erosion of sediment off the project site. Place the silt fences beyond the toe of the fill slope as shown in [Figure 30.3A](#). All silt fences must be cleared periodically as sediment is collected. The anticipated reach of the contractor's equipment can be assumed to be 15 feet.

Height of Fill (y) (feet)	Fill Slope	Minimum Silt Fence Offset from Toe of Slope (x) (feet)	Minimum Right of Way Offset from Toe of Slope (z) (feet)
<6	2H:1V	2	3
	4H:1V		
	6H:1V		
6-10	2H:1V	12	13
	4H:1V	3	4
	6H:1V	3	4
>10	2H:1V	12	13
	4H:1V	4	5
	6H:1V	4	5

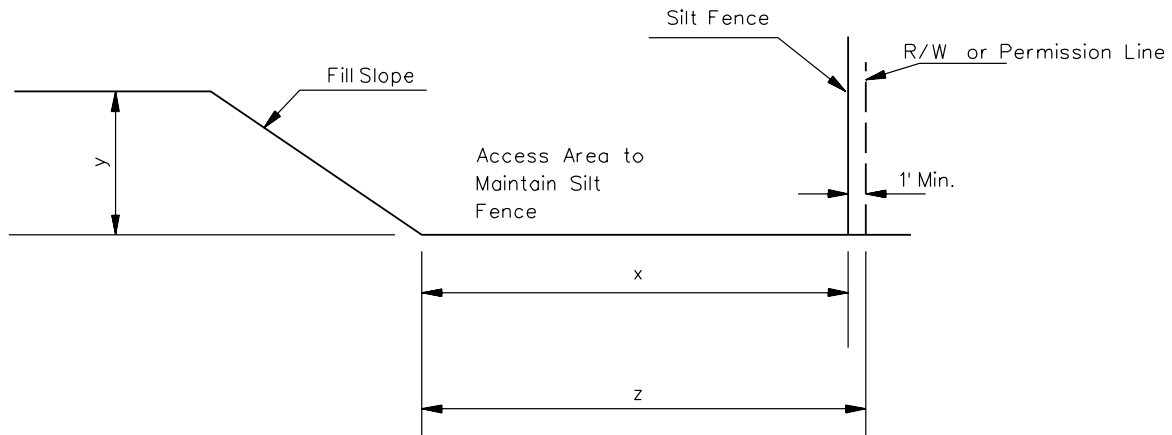

SILT FENCE OFFSETS

Figure 30.3A

An area between the silt fence and the toe of slope is needed to properly maintain the silt fence. Large equipment and trucks may use the area in front of the silt fence to access and remove of any sediment collected by the silt fence or a nearby silt basin. It is expected that the area between the NPDES line and the toe of the slope is cleared and grubbed during construction and maintained with temporary seeding. When this additional area in front of the silt fence cannot be obtained, the maintenance of the silt fence will be handled as best as practical during construction.

Right of way limits in cut slope areas should be determined during the Design Field Review where interceptor ditches or other erosion control items are deemed necessary. The right of way line should maintain a uniform alignment and not fluctuate in and out, where practical. The designer should use discretion when establishing right of way boundaries in order to minimize areas not needed for the construction and maintenance of the project.

Additional areas to be cleared and grubbed for NPDES will be shown on the Plans when they are outside the construction lines. A special line denoting the additional area needed to accommodate items of work to meet the NPDES requirements should be placed on the plans only when it is necessary to go beyond the cut/fill slope line (construction line). The NPDES line will have offset distances from the construction centerline placed at each station and turned at right angles from the centerline. This special line can be found in the custom line style palette and is shown here:

--- NPDES ----- NPDES ----- NPDES -----

NPDES LINE

30.3.3.4 Coordination of Hydrology/NPDES Studies with the Right of Way Office

It is always preferable to have the complete final hydraulic and NPDES designs shown on the plans for right of way acquisition. When the final hydraulic/NPDES designs are not available to be placed on the right of way plans, make every effort to include all hydraulic/NPDES designs that affect right of way. However, when Right of Way Plans have been sent to the Right of Way Office prior to receiving the final hydraulic and NPDES studies, revisions to the Plans, especially to the existing hydrology and erosion control elements, can be expected. Upon receipt of the final hydraulic and NPDES design from the Hydraulic Engineering Section, the Road Design Group will make the necessary revisions, noting appropriately on each sheet where the following revisions are made: "Revisions made in accordance with the hydraulic and/or NPDES studies dated _____ (Project Manager/Program Manager initials and date)."

The Road Design Group will forward the revised sheets to the Right of Way Section. If hydraulic/NPDES revisions are made to parcels that have already been acquired (including permission granted), then the Right of Way Section should contact the Hydraulic Engineering Section and the Road Design Group to attempt a resolution before finalizing the revisions and revisiting the property owner.

30.3.4 Construction Limits

The determination and delineation of accurate construction limits on the drawings are critical to the establishment of the new right of way boundaries. These limits are to be checked by reviewing the cross sections and accurately transferring this information to the Right of Way Plans. In areas not covered by cross sections, variances in terrain will be carefully reviewed to insure that the limits of construction represent the actual conditions expected during construction.

The accurate depiction of offset values and notation of cut “C” or fill “F”, for each construction limit represented by a cross section, is required on the Plans and will provide a check against the newly established right of way boundaries.

30.3.5 Breaks In Rights-of-Way

Changes between varying widths of right of way may be achieved through the 90-degree method or the transition method. The 90-degree method entails a double offset at a single station along the alignment (40 feet left of Station 71+00 and 30 feet left of Station 71+00). The transition method entails a single offset at a pair of unlike stations along the alignment (40 feet left of Station 71+00 and 30 feet left of Station 81+00).

Where it is necessary to have breaks in the right of way and the location is near a property line, the designer should not use the property line as a break; however, when it is necessary to convert permission to right of way, it is acceptable to tie right of way breaks to property lines. For more information on how to show breaks in the Right of Way Plans, see the *Road Design Plan Preparation Guide*.

30.3.6 Control of Access

The Project Planning Report will identify the type of access proposed for each project. Full control of access will be utilized on all freeways. Additionally, full control of access may be utilized on other routes of importance as approved on a case-by-case basis. Other routes may be designed using limited control of access.

All routes having fully controlled access or limited access should be clearly denoted on the project plan and profile drawings. Any proposed breaks in the controlled access line (other than access points offered at interchanges and sometimes at intersections) should be clearly identified on the Right of Way Plans in the following suggested manner:

BEGIN C/A STA.10+50 END C/A STA 11+40

This break in access will also be recorded on the right of way instrument of record.

On projects having limited access control, allowing vehicular access to the main facility, via at-grade intersections with side roads, the control of access line will turn away from the main facility and follow the side road right of way to a point approximately 250 feet from the main road right of way line. See [Section 9.8](#) for more details on access management.

30.3.7 Triangular Areas

Triangular areas are necessary for construction purposes, as well as sight distance control, and should be acquired as normal right of way. Sight distance, for vehicles approaching at-grade intersections, is a major design consideration for most roadway projects. Generally, a driver's line of sight will fall outside the limits of uniform right of way at the intersection of two roadways. To insure sufficient line of sight area is available and to perpetually protect the area from obstructions, all quadrants are to be checked for sight distance requirements.

When determining triangular areas at intersections, be aware of proper shoulder width, ditch construction around the radius and placement of pipe or structures that may require extra right of way.

Once the required triangular area is determined, clearly show this area on the Right of Way Plans and include a note that indicates the additional area required. For more information on triangular areas, see [Section 10.4](#).

30.3.8 Traffic Control Devices

Additional right of way may be required, on certain projects, as a result of the installation and maintenance requirements for traffic control devices. The road designer is required to review all traffic control improvements required for the project and insure adequate right of way is available. Of critical importance are the locations, dimensions and construction slope requirements for all underground footings, as well as, traffic signal poles, and all supporting appurtenances.

30.3.9 Outfall/Infall Ditches

Outfall/infall ditches are defined as ditches which intercept normal roadway longitudinal ditches and/or culvert ends and carry surface water from and to the roadway facility. They may be in the form of existing ditches or proposed ditches.

Outfall ditches require right of way or permission be obtained from the property owner to construct or clean. In general, right of way should be acquired for outfall ditches on all Federal-aid projects, and on other projects, where ditches are determined to be necessary for the overall function of the drainage system and protection of the roadway. New right of way should be of sufficient width to provide for construction activities and future maintenance. A total of 30 feet, with 10 feet on one side and 20 feet on the other, has been generally accepted. Where a specific length outfall is requested, it should be measured from the mainline right of way.

30.3.10 Channel Changes

Channel changes are defined as relocations of streambeds. The relocations may be situated parallel to, or crossing, the improvements. The new right of way limits should be sufficient to cover construction and future maintenance requirements.

30.3.11 Culvert Sites

Provide a minimum space of 10 feet between the wing wall ends of a box culvert and the present or new right of way. Additional right of way may be required for energy dissipaters, paved liners, scour protection devices and the ends of box culverts.

30.3.12 Bridge Sites

In general, provide a minimum right of way width of 75 feet each side of the structure centerline, to a point 75 feet from each end of the bridge, on all projects having a single two-lane bridge. Where multilane or divided highway structures are proposed, the “proportional differences” between the existing or proposed roadway approach right of way and the additional right of way required for bridges should be established for the conditions. See [Figure 30.3B](#) for an illustration of the minimum right of way required at bridges.

Care should be taken at the point where the extra bridge right of way turns 90 degrees and intersects the approach roadway right of way. When additional embankment is placed for guardrail, the slopes can cut off access around the bridge ends for maintenance. A transitioned right of way may be appropriate in these situations.

Obtain greater than minimum bridge right of way widths on projects that do not presently have any additional right of way at bridges. If some form of additional right of way exists, which adequately encompasses the structure and appurtenance, no additional right of way will be required.

30.3.13 Bridge Construction Access

During the construction of bridges, the contractor’s equipment has to be positioned near the new bridge site to facilitate construction activities. This location will be at one of the four corners of the new bridge and will be bounded by the body of water, railroad or highway being crossed, the right of way line and a distance of a transverse line 75 feet parallel to the construction centerline from the body of water, railroad or highway. In order to provide access to this location for large equipment (e.g., a crane), an access road, a short distance along the right of way line, may have to be made available to the contractor. The access road and equipment set-up site will be noted as the “Bridge

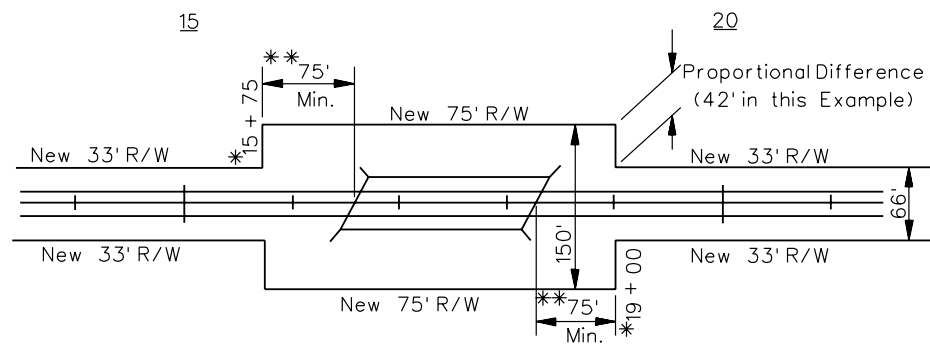

* Should be to nearest even station or 25' interval beyond 75'.

* * Adjust the length as required to preclude cutting off access to underside of bridge by the toe of fill or installation of guardrail.

RIGHT OF WAY AT BRIDGE SITES

Figure 30.3B

Construction Access (BCA) and will be shown on the Plans. During the Design Field Review, the District representative will provide the location of the BCA. The designer will sketch the location on the Plans during the field review. The Right of Way Plans will show this access by a unique line that can be found in the custom line style palette and is shown here:

--- BCA --- BCA --- BCA ---

The area within the BCA line will be cleared and grubbed during construction. A silt fence will be installed along the outer most limits of the BCA. Permission should be obtained when the BCA is shown outside the right of way, but may have to be encompassed with permanent right of way due to the amount of work required within its boundaries. A minimum of 20 feet from the fill slope is required to the BCA line. The BCA line will only be shown at one corner of the future bridge site, unless conditions require additional access on other corners of the bridge.

30.3.14 Energy Dissipaters

The use of energy dissipaters at culverts or bridges and in roadway/outfall ditches may require additional space for construction, accessibility and maintenance. If the energy dissipater is a temporary measure and all or a portion falls outside the normal right of way boundaries, adequate construction and maintenance area must be delineated on the Right of Way Plans. This additional area may be obtained through a construction and maintenance agreement with the affected property owners. A temporary easement may be acquired in some instances or permission may be obtained. If an energy dissipater is permanent, additional right of way must be obtained. In these instances, provide adequate space for construction, maintenance and access.

30.4 ELEMENTS OF RIGHT OF WAY

30.4.1 Present Right of Way

The present right of way will be clearly identified on the Right of Way Plans in accordance with the procedures provided in [Section 34.2.5](#) and the *Road Design Plan Preparation Guide*. The identification of an existing right of way line will be via the one-half total width notation. Hence, the line noting existing right of way on the left side of a roadway centered about an existing 66-foot right of way width will be shown as “PRES. 33’ R/W.”

The present right of way will be verified through right of way records, existing plans, road records, field surveys and property features (e.g., corner pins, fence lines, hedge rows, walls). Present right of way may be “dedicated right of way” and a reference to the record of dedication must be included on the Plans.

30.4.2 New Right of Way

The new right of way will be clearly identified on the Right of Way Plans in accordance with the procedures provided in [Section 34.2.5](#) and the *Road Design Plan Preparation Guide*. The normal identification of a new right of way line will be via the one-half total width notation. Hence, the line noting new right of way on the left side of a roadway centered about a proposed 100-foot right of way width will be shown as “NEW 50’ R/W.”

30.4.3 Right of Way Markers

Only use right of way markers on facilities having control of access and other rural facilities. See the *SCDOT Standard Drawings* for construction and installation details. Install right of way markers according to following criteria:

- at break points in the right of way lines;
- at points on the right of way line opposite proposed curvature points of control (e.g., PC, PT);
- at points along the right of way line which maintain forward and back line of sight;
- in rural areas, a maximum distance between any two markers along a continuous right of way line should be 1,400 feet on tangents and 700 feet on curves;
- in urban areas, a maximum distance between any two markers along a continuous right of way line should be 500 feet on tangents and curves; and

- ideally, right of way markers should not be placed at points that are common to property lines and/or corners.

30.4.4 Property Information

In the early stages of the plan development process, each parcel of property where acquired right of way is anticipated will be given a consecutive tract number assigned in the direction of stationing. While property ownership may change during development of the project, the pre-assigned parcel identification numbers will not change. It is common practice to include all contiguous properties of a single owner as one tract.

Should realignments affect additional properties, they may be assigned new whole numbers, continuing consecutively from the last whole number used. Should a pre-numbered property be divided or sub-divided, the new parts of the original tract will be identified by using the original whole number followed by a letter suffix (e.g., 12-A, 12-B, 12-C). Should a previously numbered parcel be deleted, the notation "OMITTED" may be entered under the column of the summary sheet showing the property owner's name.

[Section 34.2.5](#) and the *Road Design Plan Preparation Guide* present the information that is required on the plan sheets.

If appropriate to the project's geographic location and where information is available, divide the areas to be obtained into highlands and marshlands. For marshlands, only include those areas identified as permissible wetlands. Include all other marshlands in the highland classification.

Where a parcel of land is severed by the proposed improvement, areas remaining left and right of the mainline facility are indicated on the right of way plans via a summation of the total areas. If marshlands are involved, they are further divided into highlands and marshlands remaining left and right.

30.4.5 Identification of Property Features and Improvements

Those elements which clearly define a property may include, but are not limited to, property lines, subdivision boundaries, buildings, trees, shrubs, flower beds, water wells, septic tanks, leech fields, retaining walls, drives, sidewalks, outbuildings, garages, swimming pools, etc. All or any one of these items may be critical to, or instrumental in, the establishment of new right of way boundaries. All are important items as they relate to property appraisals. Each of these items are to be shown on the Right of Way Plans and clearly referenced by their characteristics. For example, the limits of a drainfield are shown; width and material type indicated for sidewalks and drives; width, height and material type indicated for retaining walls; height and material type indicated for fences;

number of stories, type and usage of buildings (e.g., 2-story frame residential or 1 story brick commercial), etc. Items such as underground storage tanks (UST's), landfills, dumpsites or other features, which may have environmental implications, should also be identified by size and location.

Determine the limits of topographic identification during the request for survey stage of plan development. A general guide to the limits of topography should be in the range of 50 to 100 feet beyond the anticipated new right of way boundaries. This must be reviewed and analyzed on a project-by-project basis.

30.4.6 Property Purchase vs. Easements

Because easements generally restrict the usage of lands to the prescribed activity contained on the instrument of record, and the actual cost to acquire a highway easement is historically in the neighborhood of the actual cost of obtaining clear title to the same property, it is the usual practice of the Department to acquire right of way easements only on projects funded with State Secondary "C" funds. All other type projects typically require that the properties be acquired in fee simple. However, there are situations in which it is not in the Department's best interest to acquire fee title. Therefore, the Right of Way Office retains the discretion to acquire title in the manner that best suits its needs on all projects.

30.4.7 Condemned Parcels

Whenever the Department is unable to successfully negotiate the acquisition of the real property needed for construction, title to an interest in the property may be acquired pursuant to the Eminent Domain Procedure Act, S.C. Code ANN. §28-2-10 et seq., as amended. This Act specifies the means and methods necessary to condemn property for public projects.

30.4.8 Dedicated Right of Way

Dedicated right of way is property conveyed to a public-governmental entity, by a private source, for public use and benefit. This property must be accepted by a public body for the dedication to be valid.

30.4.9 Property Closures

Property closures, developed by survey parties, generally depict the metes and bounds description of property as obtained from available deed and plat records. Because the property work files are preserved, it is not mandatory that the metes and bounds information be repeated on the property closures depicted on the Right of Way Plans.

Each property closure shown in the plans must clearly depict the graphical boundaries of the entire parcel and the graphical area to be acquired. Where right of way is necessary, the affected tracts are numbered, computed and recorded under the property owners name on the Right of Way Data Sheet.

On normal bridge replacement projects, where the Bridge Project Manager is the responsible engineer, it is not necessary to close the property. Property lines and owner names should be shown as on a secondary project.

30.4.10 Encroachments

Highway encroachments occur when persons other than the Department's staff or the Department's authorized agents place items within existing highway right of way. No encroachments, of any type, are allowed on highway rights of way without an official encroachment permit.

30.4.11 Land Locked Parcels

A parcel of land is land locked when it has no legal access. One form of legal access is provided via public roads. It may also be provided via rights of ingress/egress through abutting properties through some form of legal instrument between two or more parties (e.g., a condition of the deed, official agreement easement).

A parcel of land may be land locked as it exists or may become land locked as a result of highway improvements. In either case, land locked properties should be duly noted in the comments column on the Right of Way Acquisition Summary Sheet and on the Plan and Profile sheets. In some cases the land locked parcel may be incorporated into the right of way or may be acquired as excess land. The Right of Way Office will make the final determination whether to acquire these properties.

30.4.12 Federal Government Properties

When a project requires the acquisition of right of way from the U.S. Government, the Right of Way Office must be provided the following:

1. Develop a plat of the total tract, from field surveys or plats, showing the metes and bounds description of the tract perimeter. The plan accuracy should be in accordance with the requirements of the affected governmental agency. The new plat will indicate "composite plat" if developed from previously platted information.
2. Show true error of closure for the tract to be acquired or indicate that error of closure exceeds that required.

3. Show and describe, by metes and bounds, all courses of the area to be acquired.
4. Provide a tie to a known existing property corner.
5. Provide the following minimum information for curved lines:
 - length of arc,
 - length of chord,
 - bearing of chord, and
 - radius of arc.

Each plat should show references to existing deeds and plats as well as reference to the roadway project and file number.

The plat, along with all other information required by Appendix 1 – *Application for Federal Land Transfers, 23 CFR, Section 712, Subpart E*, must be submitted to the appropriate Federal agency for processing.

30.4.13 Right of Way Deeds/Easements

The primary function of Right of Way Plans and instruments is to provide the necessary tools by which the Department acquires all real property in the form of fee simple titles or easements for the State's secondary, primary and Interstate roads systems.

Standard forms of right of way instruments include titles to real estate, right of way easements, permission forms and notices of condemnation. These standard documents are available from the Right of Way Office.

30.4.13.1 Deed Descriptions

The description portion of a right of way deed defines the parcel to be acquired and should reference to the survey centerline using the station and offset method, or to an exhibit developed from the Plans. A reference to the Right of Way Plans project and file numbers is contained in each right of way deed.

30.4.13.2 Permanent Easements (Outside the Right of Way)

Permanent easements provide the Department the right to occupy the property of others for a designated purpose, usually construction and maintenance of a highway or drainage rights, in perpetuity. The easement can only be extinguished by the Department, or by court order.

30.4.13.3 Temporary Construction Easements

Temporary easements provide the Department the right to occupy the property of others for a designated purpose (e.g., drainage, access, detour construction) over a limited period of time. The purpose and time period must be clearly defined. The time may be designated as actual completion of the work. At the end of the period, the easement is extinguished. The note on the Plans should state, "OBTAIN TEMPORARY RIGHT OF WAY."

30.4.13.4 Property Records

The permanent records of all real property owned by the Department are in custody of the Right of Way Office. Title to all Department-owned property, acquired after April 1, 1988, is recorded in the *Register of Deeds* in the county courthouse in which the property is situated, and also filed in the vault of the Department's Right of Way Office in the central office. All deeds for property acquired prior to April 1, 1988, are recorded in the vault of the Department's Right of Way Office in the central office.

30.4.14 Special Features

The items in the following Sections will be occasionally encountered on highway projects.

30.4.14.1 Retaining Walls

Where it becomes necessary to construct retaining walls to contain cut or fill slopes, the backs of walls, the face of a wall farthest from the traveled way, is established as the right of way limit. Depending upon the design of wall footings, permission may be required to construct and maintain footings. If permission cannot be obtained for footing construction, acquisition of sufficient right of way to construct and maintain walls and footings will be required.

In situations where the landowner negotiates for a wall, in lieu of slope permission, the right of way will be established as the front of the wall. After acceptance from the contractor, the wall will become the property of the landowner. The right of way instrument will reflect the property owner's responsibility for walls, any temporary right of way required for construction and indicate future maintenance to be the responsibility of the landowner.

30.4.14.2 Cemeteries

Cemeteries should be identified at the beginning of preliminary studies and referenced in the Project Planning Report. Avoid disturbances to cemeteries to the extent possible. If no alternative appears available, the Director of Rights of Way should be informed immediately. Locate all graves near the improvement via surveys and show them on the Plans.

30.4.14.3 4(f) and 6(f) Lands

Except under pre-determined conditions, Section 4(f) of the *Department of Transportation Act of 1966* prohibits use, for Federal-aid highway projects, of land from a public-owned park, recreation area or wildlife/waterfowl refuge, or any historic or archaeological site listed or eligible for listing on the National Register of Historic Places. Additionally, Section 6(f) of the *Land and Water Conservation Fund Act* prohibits the acquisition of recreational land, purchased or developed with Land and Water Conservation monies, without replacement "in kind" and without receipt of prior approval of the Secretary of the Interior.

As applicable, involvement of a highway project with a Section 4(f) and Section 6(f) property must be resolved prior to the right of way authorization of the project. Designers involved with establishing right of way, construction limits, borrow sites, etc., should carefully review all environmental documents relative to the project, especially the Section 4(f) Evaluation, Record of Decision (ROD), any Memoranda Of Agreement with the State Historic Preservation Office and others. These memoranda will contain specific measures, which have been agreed upon, to minimize the impact of the highway project on 4(f) and 6(f) property.

The draft or final environmental document should be reviewed for descriptions of any monitoring or enforcement program that may have been adopted. The full text of these programs should be reviewed for adherence during the Right of Way Plan development stage.

30.5 REFERENCES.

1. *Right of Way Manual*, South Carolina Department of Transportation, current edition.
2. *United States Uniform Relocation Assistance and Real Property Acquisition Policies Act of 1970* (Public Law 91-646), *United States Code*, as amended.
3. *South Carolina Code of Laws*, Titles 28 and 57, as amended.
4. *A Policy for Accommodating Utilities on Highway Rights of Way*, South Carolina Department of Transportation, as revised.
5. *Highways and You*, South Carolina Department of Transportation, current edition.
6. *Codes of Federal Regulations, Title 23 United States Code and Title 49 United States Code*, as amended and related.
7. *National Environmental Policy Act of 1969, United States Code*, as amended and related *Codes of Federal Regulations*.
8. *Road Design Plan Preparation Guide 2000*, South Carolina Department of Transportation, 2000.

Table of Contents

<u>Section</u>	<u>Page</u>
31.1 SCDOT DOCUMENTS	31.1(1)
31.1.1 Hydraulics	31.1(1)
31.1.1.1 <i>Specification Support Manual for GEOPAK Drainage</i> ..	31.1(1)
31.1.1.2 <i>Requirements for Hydraulic Design Studies</i>	31.1(2)
31.1.2 Right of Way.....	31.1(2)
31.1.2.1 <i>Right of Way Appraisal Manual</i>	31.1(2)
31.1.2.2 <i>Right of Way Acquisition Manual</i>	31.1(2)
31.1.2.3 <i>Right of Way Relocation Assistance Manual</i>	31.1(2)
31.1.3 Traffic Engineering	31.1(3)
31.1.3.1 <i>Access and Roadside Management Standards</i>	31.1(3)
31.1.3.2 <i>Advanced Work Zone Safety Guidelines</i>	31.1(3)
31.1.3.3 <i>SCDOT Work Zone Safety Guidelines Handbook</i>	31.1(3)
31.1.3.4 <i>Traffic Controls for Streets and Highway Construction and Maintenance Operations</i>	31.1(4)
31.1.3.5 <i>Approved Products List for Traffic Control Devices in Work Zones</i>	31.1(4)
31.1.3.6 <i>Traffic Calming Manual</i>	31.1(4)
31.1.3.7 <i>Traffic Signal Design Guidelines</i>	31.1(4)
31.1.4 Construction	31.1(5)
31.1.4.1 <i>Standard Specifications for Highway Construction</i>	31.1(5)
31.1.4.2 <i>Supplemental Specifications</i>	31.1(5)
31.1.5 Road Design	31.1(5)
31.1.5.1 <i>Road Design Plan Preparation Guide</i>	31.1(5)
31.1.6 CADD	31.1(6)
31.1.6.1 <i>Road Design CADD Users Guide</i>	31.1(6)
31.1.6.2 <i>SCDOT Standard Drawings</i>	31.1(6)

Table of Contents

(Continued)

<u>Section</u>	<u>Page</u>
31.1.7 Survey	31.1(7)
31.1.7.1 <i>SCDOT Survey Manual</i>	31.1(7)
31.2 OTHER DOCUMENTS	31.2(1)
31.2.1 <i>A Policy on Geometric Design of Highways and Streets</i>	31.2(1)
31.2.1.1 Description	31.2(1)
31.2.1.2 Department Application	31.2(1)
31.2.2 <i>Roadside Design Guide</i>	31.2(1)
31.2.2.1 Description	31.2(1)
31.2.2.2 Department Application	31.2(2)
31.2.3 <i>Model Drainage Manual</i>	31.2(2)
31.2.3.1 Description	31.2(2)
31.2.3.2 Department Application	31.2(2)
31.2.4 <i>Highway Capacity Manual</i>	31.2(3)
31.2.4.1 Description	31.2(3)
31.2.4.2 Department Application	31.2(3)
31.2.5 <i>Manual on Uniform Traffic Control Devices</i>	31.2(3)
31.2.5.1 Description	31.2(3)
31.2.5.2 Department Application	31.2(3)
31.2.6 <i>ADA Accessibility for Buildings and Facilities</i>	31.2(4)
31.2.6.1 Description	31.2(4)
31.2.6.2 Department Application	31.2(4)

Chapter Thirty-one

MISCELLANEOUS DEPARTMENT DOCUMENTS

The *SCDOT Highway Design Manual* is not intended to present all the information that may be needed by the road designer; however, the *Manual* does include the majority of the road design information typically needed for most of the projects designed by the Road Design Section.

For specific projects or for specific project elements, the road designer may need to reference other publications in order to perform a fully comprehensive analysis of the project. This Chapter briefly discusses other publications of the national highway engineering literature and those published by the South Carolina Department of Transportation.

31.1 SCDOT DOCUMENTS

The Department has prepared many publications in addition to the *SCDOT Highway Design Manual* that may apply to a road design project. This Section briefly discusses other relevant SCDOT publications.

31.1.1 Hydraulics

31.1.1.1 *Specification Support Manual for GEOPAK Drainage*

The Hydraulic Engineering Section is responsible for and maintains the *Specification Support Manual for GEOPAK Drainage*. The GEOPAK Drainage software is SCDOT's primary storm sewer design package. The purpose of this *Manual* is to assist in the use of the GEOPAK drainage software and to set standards for drafting (e.g., naming conventions, levels, colors). This establishes a format that is easily transferable to the Road Design Section. The *Manual* presents the following information:

- explanations of files and drives;
- exchanges of information;
- downloading and organizing files for the Road Design and Hydraulic Engineering Sections;
- designing a storm drainage system using GEOPAK;
- special discussions (i.e., outlet definition, COGO, Navigator);
- uploading files; and
- troubleshooting.

31.1.1.2 Requirements for Hydraulic Design Studies

The Hydraulic Engineering Section is responsible for the *South Carolina Requirements for Hydraulic Design Studies*, which presents design criteria on the following topics:

- hydraulic surveys;
- hydrologic methods used in South Carolina;
- hydraulic design of culverts, open channels, bridge waterway openings and closed drainage systems; and
- erosion control.

31.1.2 Right of Way

The Right of Way Office is responsible for the Department documents presented in this Section.

31.1.2.1 *Right of Way Appraisal Manual*

The *Right of Way Appraisal Manual* provides guidelines for both staff and fee appraisers in the preparation of appraisal reports used by SCDOT in the acquisition of right of way for road construction. This *Manual* does not cover all facets of the appraisal process, but should be used as guidance for preparing the various types of appraisal reports.

31.1.2.2 *Right of Way Acquisition Manual*

The *Right of Way Acquisition Manual* is the working *Manual* for Right of Way Acquisition personnel. This *Manual* consolidates information and provides instructions about the organization, operation and procedures of the Right of Way Office. The purpose of this *Manual* is to obtain uniformity of action and to maximize the efficiency of Right of Way personnel.

31.1.2.3 *Right of Way Relocation Assistance Manual*

The *Right of Way Relocation Assistance Manual* is the working *Manual* for Right of Way Relocation personnel. This *Manual* provides the policies and procedures followed during the relocation of persons, families, businesses and farms that are displaced as a result of the acquisition of real property for public purposes.

31.1.3 Traffic Engineering

The Traffic Engineering Division is responsible for the Department documents presented in this Section.

31.1.3.1 *Access and Roadside Management Standards*

The *Access and Roadside Management Standards* addresses points of access on public highways in South Carolina. It presents criteria that provide uniformity for encroachments upon roads and streets in the State Highway System. It provides for the safe and efficient movement of traffic while allowing reasonable access to abutting property. The *Standards* cover the following issues:

- encroachment permits,
- points of access,
- geometric design,
- roadside encroachments,
- drainage, and
- construction.

31.1.3.2 *Advanced Work Zone Safety Guidelines*

This document presents guidelines for establishing safe work zones on expressways, freeways, Interstates and other mobile operations. The information contained in this document illustrates the principles of proper work zone traffic control, but should not be viewed as standards.

The topics covered in the *SCDOT Advanced Work Zone Safety Guidelines* include:

- traffic control devices,
- five parts of a traffic control zone,
- typical applications,
- legal liability,
- inspection, and
- maintenance.

31.1.3.3 *SCDOT Work Zone Safety Guidelines Handbook*

This handbook is based on the *Advanced SCDOT Work Zone Safety Guidelines*. It is intended for field personnel, municipalities, counties, utilities and contractors. It presents the guidelines and information discussed in [Section 31.1.3.2](#).

31.1.3.4 Traffic Controls for Streets and Highway Construction and Maintenance Operations

This publication is a pamphlet that is intended to provide a consistent system of traffic control devices and markings throughout South Carolina.

31.1.3.5 Approved Products List for Traffic Control Devices in Work Zones

This publication contains specific information on work zone traffic control devices approved for use in South Carolina. All devices listed have been tested to NCHRP Report 350 requirements. Included in the publication are device descriptions, dates of approval, manufacturers and remarks.

31.1.3.6 *Traffic Calming Manual*

Traffic calming is also known as neighborhood traffic control, traffic restraint, local-area traffic management and environmental management. Traffic calming is a method to physically and visually impede speeding and congestion on local roads. The *SCDOT Traffic Calming Manual* addresses innovative traffic control devices (e.g., changes in street alignment, installation of barriers, other physical measures) that are designed to achieve reductions in traffic speed and non-local traffic volumes.

The topics covered in this document are:

- traffic calming description;
- eligibility criteria;
- the four E's (i.e., engineering, enforcement, education, economics);
- program agreement;
- project process;
- maintenance;
- resources; and
- funding.

31.1.3.7 *Traffic Signal Design Guidelines*

This document is intended to provide uniformity in the review, decision-making and the design of traffic signals. This document presents the methodology for review, design, installation, operation and maintenance of traffic signals as well as traffic signal requests. Special design guidelines (e.g., pedestrian signal treatment, railroad preemption design) are also included in this document.

31.1.4 Construction

31.1.4.1 *Standard Specifications for Highway Construction*

The Construction Division is responsible for the *South Carolina Standard Specifications for Highway Construction*. The *Standard Specifications* present the work methods and materials approved by the Department for the construction of road, traffic and bridge projects. The publication presents information on:

- bidding,
- awarding the contract,
- contractor duties,
- controlling material quality,
- contractor and Department legal requirements,
- executing the contract, and
- measuring and paying for contract items.

31.1.4.2 *Supplemental Specifications*

Supplemental Specifications modify the requirements set forth in the latest version of *Standard Specifications*.

31.1.5 Road Design

31.1.5.1 *Road Design Plan Preparation Guide*

The Road Design Section is responsible for the *Road Design Plan Preparation Guide*. This document presents technical guidelines for the preparation of construction plans developed by and for the Road Design Section. It is intended to provide uniformity, clarity and accuracy to SCDOT's construction plans. The *Road Design Plan Preparation Guide* should be used in conjunction with the *SCDOT Highway Design Manual*, applicable AASHTO Manuals and any directives issued by the Department. The topics covered include the following:

- Plan Covers,
- Title Sheets,
- Plan Index Sheet,
- Quantity Sheets,
- Special Drawings,
- General Construction Notes,
- Miscellaneous Notes,
- Typical Sections,
- existing topography and profile,

- horizontal alignment,
- vertical alignment,
- drainage structures,
- clear zone,
- cross sections,
- right of way information,
- bridge information,
- railroad information,
- pavement design,
- quantity computations,
- sediment and erosion information,
- quality control and assurance, and
- specifications.

31.1.6 CADD

31.1.6.1 *Road Design CADD Users Guide*

The Road Design Section is responsible for the SCDOT's *Road Design CADD Users Guide*. The *Manual* contains the Department criteria relating to:

- accessing the CADD software;
- creating, editing and referencing files;
- descriptions and applications of commands;
- element placement and usage;
- cell management;
- fonts and formatting; and
- plotting.

31.1.6.2 *SCDOT Standard Drawings*

The Road Design Section is responsible for maintaining the *SCDOT Standard Drawings*. The *SCDOT Standard Drawings* provide details on various design treatments that are consistent from project to project (e.g., guardrail, fencing, drainage details). They provide information on how to layout and/or construct the design elements.

31.1.7 Survey

31.1.7.1 *SCDOT Survey Manual*

The Surveys Office is responsible for the *SCDOT Survey Manual*, which presents the Department's criteria for the following:

- survey datums and coordination systems,
- survey measurements and equipment,
- errors and maximum closure,
- preliminary surveys,
- property corner ties,
- notekeeping, and
- construction surveys.

31.2 OTHER DOCUMENTS

For relevant national publications, this Section provides a brief description of each publication and its application on Department projects.

31.2.1 A Policy on Geometric Design of Highways and Streets

31.2.1.1 Description

The AASHTO publication, *A Policy on Geometric Design of Highways and Streets*, more commonly known as the *Green Book*, discusses the nationwide policies, practices and criteria for the geometric design of highways and streets. It is intended to present a consensus view on the most widely accepted approach to the design of a variety of geometric elements including design speed, horizontal and vertical alignment, cross section widths, intersections and interchanges.

31.2.1.2 Department Application

Several of the Chapters within this *SCDOT Highway Design Manual* address geometric design elements. The *Manual's* geometric design treatments have been based on the *Green Book*, but tailored to the prevailing climate, topography and practices within South Carolina. Also, the *Manual* is intended to clarify, where needed, specific presentations in the *Green Book* and to discuss geometric design information not presently included in the *Green Book*.

31.2.2 Roadside Design Guide

31.2.2.1 Description

The *AASHTO Roadside Design Guide* presents the nationwide policies, practices and criteria for roadside safety along highways and streets. It is intended to present a consensus view on the most widely accepted approach to providing a reasonably safe roadside for run-off-the-road vehicles. The *Roadside Design Guide* discusses clear zones, drainage appurtenances, sign and luminaire supports, roadside barriers, median barriers, bridge rails, crash cushions and roadside safety within construction work zones. The overall objective of the *Roadside Design Guide* is to recommend an appropriate roadside safety treatment for specific sites considering the consequences of a vehicle running off the road, specific roadway features (e.g., traffic volumes, design speed, roadside topography) and construction/maintenance costs.

31.2.2.2 Department Application

[Chapter 14](#) in the *SCDOT Highway Design Manual* addresses roadside safety.

The roadside safety criteria presented in [Chapter 14](#) is based on the criteria presented in the *AASHTO Roadside Design Guide*, but tailored to the prevailing practices and conditions in South Carolina. Also, the *SCDOT Highway Design Manual* is intended to clarify, where needed, the presentations in the *Roadside Design Guide* and to discuss roadside safety information not included in the AASHTO publication.

31.2.3 Model Drainage Manual

31.2.3.1 Description

The *AASHTO Model Drainage Manual (MDM)* presents the nationwide criteria for the hydrologic and hydraulic design of drainage appurtenances for highway projects. The *MDM* discusses the most commonly used hydrologic methods in the United States (e.g., the Rational Method), and it discusses hydraulic design of various drainage appurtenances (e.g., open channels, culverts, bridges, closed drainage systems, energy dissipators). The *MDM* supersedes, incorporates or references the FHWA Hydraulic Engineering Circulars and Hydraulic Design Series publications. The overall objective of the *MDM* is to present hydraulic design criteria for highway drainage features which properly consider the probability of an extreme hydraulic event, the consequences of that event and the costs of providing a drainage system that will accommodate that event.

31.2.3.2 Department Application

The Hydraulic Engineering Section is typically responsible for the hydraulic design of drainage appurtenances for all highway projects under the jurisdiction of the Department. The design is based on criteria in the *AASHTO Model Drainage Manual*, the *South Carolina Requirements for Hydraulic Design Studies* and general Departmental practices in hydrology and hydraulics. Where conflicts exist between the *MDM* and SCDOT practices, the Hydraulic Engineering Section will determine the proper application.

[Chapter 29](#) in the *SCDOT Highway Design Manual* primarily discusses structural requirements for drainage appurtenances (e.g., maximum heights of fill and wall thickness for pipe culverts). It does not address hydrology and hydraulics.

31.2.4 Highway Capacity Manual

31.2.4.1 Description

The *Highway Capacity Manual (HCM)* and its associated software, published by the Transportation Research Board, present the nationwide criteria for performing capacity analyses for highway projects. The *HCM* includes methodologies for freeways, weaving areas, freeway and ramp junctions, two-way two-lane facilities, intersections, etc. The basic objective of the capacity methodologies in the *HCM* is to determine the necessary configuration and dimensions of a specific highway element to accommodate the projected traffic volumes at a given level of service.

31.2.4.2 Department Application

The Traffic Engineering Division performs all needed capacity analyses for Department projects. The *Highway Capacity Manual* and its associated software is used for all analyses with some adjustments for local highway capacity factors.

31.2.5 Manual on Uniform Traffic Control Devices

31.2.5.1 Description

The *Manual on Uniform Traffic Control Devices (MUTCD)*, published with the combined efforts of FHWA, AASHTO, ATSSA and ITE, presents nationwide criteria for the selection, design and placement of all traffic control devices. This includes highway signs, pavement markings and traffic signals. The basic objective of the *MUTCD* is to establish an effective means to convey traffic control information to the driver for uniform application nationwide. The *MUTCD* information is divided into four categories — standard, guidance, option and support. These categories are used to establish the proper application of *MUTCD* criteria for all public roads and streets within the United States.

31.2.5.2 Department Application

The Traffic Engineering Division is responsible for the use of traffic control devices on all projects under the jurisdiction of the Department. The Department has adopted the use of the *MUTCD* in its entirety, including the context of its presentation. The *SCDOT Standard Drawings* and *South Carolina Traffic Controls for Streets and Highway Construction and Maintenance Operations Manual* present additional information on traffic control devices, which supplements the criteria in the *MUTCD*.

31.2.6 ADA Accessibility for Buildings and Facilities

31.2.6.1 Description

The *ADA Accessibility Guidelines for Buildings and Facilities*, published by the U.S. Architectural and Transportation Barrier Compliance Board, presents the nationwide accessibility criteria to buildings and facilities for individuals with disabilities. The basic objective of this document is to establish the criteria mandated by the *Americans with Disabilities Act (ADA)* of 1990. It provides accessibility criteria for both interior and exterior facilities including parking spaces, sidewalks, hallways, doorways, curb ramps, ramps, stairs, telephones, drinking fountains, rest rooms, elevators, etc.

31.2.6.2 Department Application

The Department's accessibility criteria meet the *ADA Accessibility Guidelines for Buildings and Facilities*. [Chapter 17](#) of the *SCDOT Highway Design Manual* addresses the exterior accessibility features the designer will typically encounter (e.g., sidewalks, parking spaces, ramps, curb ramps). For interior features (e.g., rest areas), the designer should use the requirements presented in the *ADA Accessibility Guidelines for Buildings and Facilities*.

Chapter Thirty-two
RESERVED

Table of Contents

<u>Section</u>	<u>Page</u>
33.1 DESIGN PROCESS	33.1(1)
33.2 DESIGN FIELD REVIEW (30 PERCENT)	33.2(1)
33.2.1 Project Planning Report.....	33.2(1)
33.2.2 Project Location Controls	33.2(1)
33.2.3 Stationing Alignments.....	33.2(2)
33.2.4 Survey Requirements	33.2(3)
33.2.5 Preliminary Drainage Design.....	33.2(3)
33.2.6 Right of Way Control	33.2(4)
33.2.7 Typical Sections	33.2(4)
33.2.8 Cross Sections	33.2(4)
33.2.9 Intersection Details	33.2(5)
33.2.10 Interchanges.....	33.2(5)
33.2.11 Other Design Elements	33.2(5)
33.2.12 Design Field Review	33.2(6)
33.3 RIGHT OF WAY PLANS (70 PERCENT)	33.3(1)
33.3.1 Drainage	33.3(1)
33.3.2 Environmental.....	33.3(1)
33.3.3 Right of Way.....	33.3(1)
33.3.4 Cross Sections	33.3(2)
33.3.5 Bridge Plans	33.3(2)
33.3.6 Minor Structures	33.3(3)
33.3.7 Railroads	33.3(3)
33.3.8 Intersections	33.3(3)
33.3.9 Interchanges.....	33.3(3)
33.3.10 Construction Limits	33.3(4)
33.3.11 Right of Way Limits.....	33.3(5)
33.3.12 Detours.....	33.3(5)
33.3.13 Restoration of Construction Slopes in Urban and/or Residential Locations	33.3(5)
33.4 FINAL CONSTRUCTION PLANS (90 PERCENT)	33.4(1)
33.4.1 Title Sheet	33.4(1)
33.4.2 Revisions.....	33.4(1)

Table of Contents

(Continued)

<u>Section</u>	<u>Page</u>
33.5 FINAL CONSTRUCTION PLANS (100 PERCENT)	33.5(1)
33.5.1 Purpose	33.5(1)
33.5.2 Distribution.....	33.5(1)
33.6 CONSTRUCTION PHASE	33.6(1)
33.6.1 Construction Plans Storage.....	33.6(1)
33.6.2 Final As-Built Plans	33.6(1)
33.6.3 Plan Revisions and Construction Changes	33.6(1)
33.6.3.1 Revised Plan Sheets	33.6(1)
33.6.3.2 Working Plans	33.6(2)
33.6.3.3 Title Sheet and Estimated Quantity Revisions.....	33.6(2)
33.7 PUBLIC ACCESS TO PLANS	33.7(1)
33.7.1 Public Hearing/Meeting Plans.....	33.7(1)
33.7.2 Document Fees	33.7(1)

Chapter Thirty-three

PROCEDURES FOR HIGHWAY PLANS PREPARATION

This Chapter provides an overview of the policy and procedures for the development of SCDOT's highway plans with respect to content, reviews and responsibilities. [Chapter 34](#) and the *Road Design Plan Preparation Guide* provide detailed guidelines on plan preparation.

33.1 DESIGN PROCESS

SCDOT's highway design process consists of two major phases — Preliminary Design Phase and Final Design Phase. Generally, the Preliminary Design Phase is through the Design Field Review, which is approximately 30 percent of the total design effort. The Final Design Phase represents 70, 90 and 100 percent of the completed work stages. The Final Design Phase is the process by which the Design Field Review Plans are further refined and expanded to incorporate final design details and estimates of quantities necessary to provide a contractor with all of the information required to construct the planned highway improvements. The following provides a brief description of the design completion stages:

1. Design Field Review Plans (30 percent). This stage is the end of the Preliminary Design Phase, which includes the Design Field Review and Project Planning Report.
2. Right of Way Plans (70 percent). The Right of Way Plans advance the Design Field Review Plans to a point such that all other Units (e.g., Traffic Engineering Division, Bridge Design Section, Right of Way Office) can complete their work.
3. Final Construction Plans (90 percent). This stage is reached when the Road Design Group has essentially completed the roadway design and drafting of all plan sheets that are within the Road Design Group's control. The Road Design Group will complete the Summary of Estimated Quantities Sheet once all the quantities are received from the other design Units.
4. Final Construction Plans (100 percent). The Plans are completed after the Road Design Group has received the plan sheets and quantities from the other design Units (e.g., Traffic Plans, Bridge Plans) and the quantities are incorporated into the Summary of Estimated Quantities Sheet. After processing, the Plans are forwarded to the Contracts Administration Section for letting.

Less complex road projects will generally advance from the Design Field Review Phase (30 percent) directly to the Final Design Phase (100 percent). For additional guidance on the design process, see [Chapter 3](#).

33.2 DESIGN FIELD REVIEW (30 PERCENT)

33.2.1 Project Planning Report

At the completion of the Design Field Review, the Program Manager will finalize the Project Planning Report (PPR). The PPR identifies the preferred alignment within the project corridor and establishes controls for the project design. The details given in the PPR depend on the project type, location and impacts. Typically, the Report will include the following information:

- estimated construction cost;
- social, economic and environmental impacts;
- necessary coordination with outside parties;
- traffic volumes;
- existing roadway inventory;
- design speed;
- right of way and type of access of control;
- capacity analysis and proposed level of service;
- crash data analysis;
- typical section (e.g., lanes, shoulder, median);
- intersection improvements, including exclusive right/left-turn lanes and turning roadways;
- bridge geometric improvements;
- any proposed substandard geometric features;
- need for signalization; and/or
- frontage roads.

The Road Design Group should develop the Construction Plans based upon the information contained in the PPR. These design criteria are then applied to the physical characteristics of the project to optimize the project objectives while minimizing the project cost.

33.2.2 Project Location Controls

Initial design considerations involve the establishment of the graphical location of the project and its termini. The designer should refine the schematic roadway to a cost effective geometric layout. Although straight-line links are the shortest distance between project termini or intermediate points, they may not be the most cost effective due to terrain considerations and/or possible conflicts with environmentally sensitive areas. The design group should identify the location of all critical controls. For information on alignment controls, see [Chapters 11 and 12](#).

33.2.3 Stationing Alignments

Upon completion of a graphical alignment, the designer should set the stationing of the alignment to provide a method of identification of specific locations along the alignment and as a method of coordinating locations between plan and profile views. If there are no previous stations established at adjoining areas, the designer may assign an initial beginning stationing number. It is recommended that the assigned beginning number be other than zero and preferably be an exponent of 10 (e.g., 100, 1000, 10,000). Avoiding the use of zero as a beginning station will reduce the potential of negative stationing should the project be extended in the back stationing direction.

Stationing is defined as a length of 100 feet (i.e., STA 10 is actually 10 one hundred foot lengths and is written as 10+00). In the stationing of an alignment, standard practice is to begin the stationing at the south or west termini of the project and to increase stationing numbers from south to north or from west to east. This is consistent with conventional reading from left to right for west to east stationing and from left to right for south to north stationing.

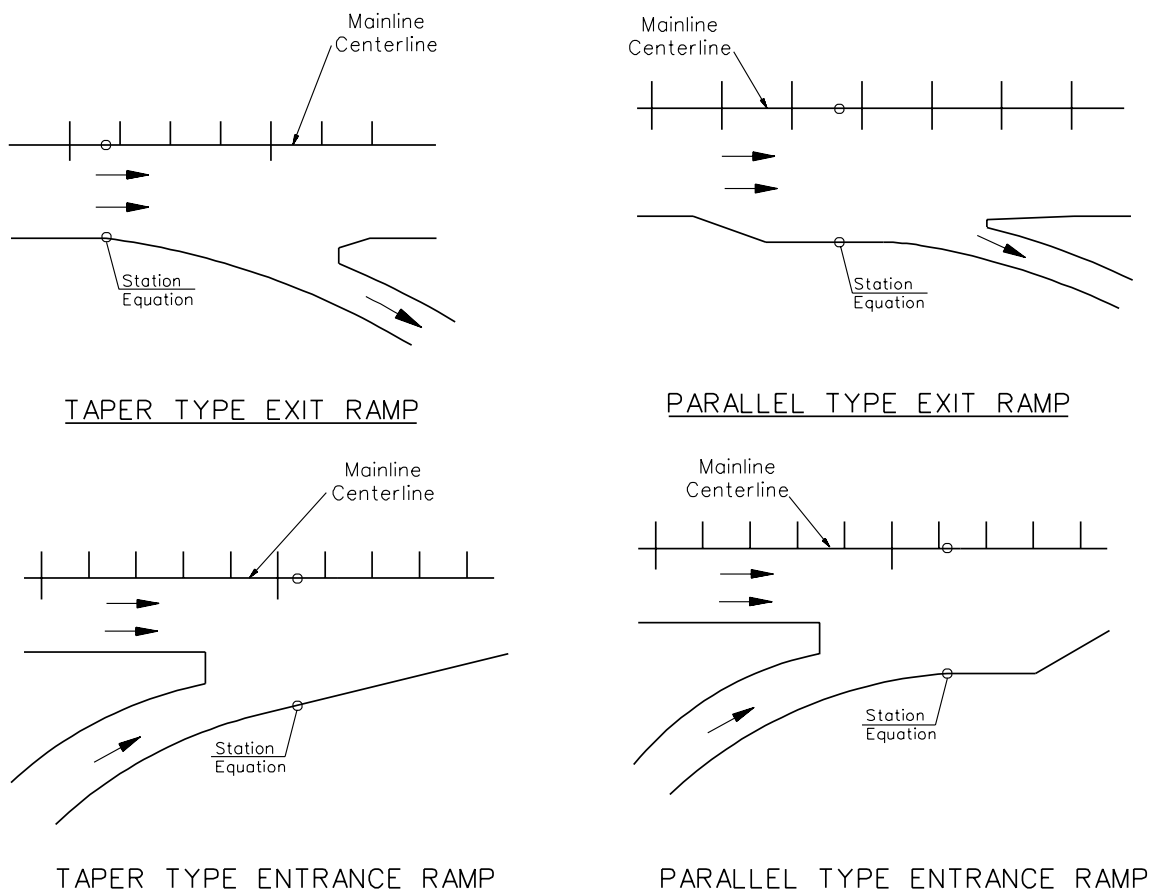

STATION EQUATIONS FOR VARIOUS RAMPS

Figure 33.1A

Stationing on ramps should increase in the same direction as the mainline. The beginning station should be common with the mainline station from which the ramp diverges (e.g., STA. 439 + 16.21, Line B is 42 feet Lt. STA. 439 + 16.21, I-85). When stationing the ramp centerline, establish the proper equality as depicted on [Figure 33.1A](#) and station the ramp forward or backward as required to maintain ramp stationing in the same increasing direction as the mainline. At an interchange, station the ramps and connecting roads to be consistent with the mainline facility.

33.2.4 Survey Requirements

The Program Manager and the Preliminary Design Group are responsible for initiating the field survey by sending a request for a survey to the Survey Office.

The determination as to the appropriate point in the project's development process to begin the field surveys will depend on a variety of factors. The main consideration is the complexity of the project. A new freeway or roadway on a new location should be developed to the point that the preliminary location and design studies have been completed before the field survey work begins. The designer may use topographic maps or other survey source materials to develop the proposed survey centerline. For smaller projects, the designer may only be required to submit the county map showing the project's location to the Survey Office to initiate the field survey.

For more detailed information on survey requirements, see the *SCDOT Survey Manual* and [Chapter 26](#) of the *Highway Design Manual*.

33.2.5 Preliminary Drainage Design

The Design Field Review Plans should identify the drainage basins that are shown on the USGS quadrangle maps. Show the drainage area that contributes to each major drainage structure and a preliminary size of drainage openings on the Plan and Profile Sheets.

Use the following procedure to develop the preliminary roadway surface drainage and the location and spacing for curb inlets:

- conduct a field drainage review with the project development team to locate outfalls and establish the basic layout of the drainage system;
- place inlets at low points and at intersections as required;
- place intermediate inlets at 150 feet to 400 feet spacing, depending on pavement width;
- consider the profile grade and additional flow from adjoining property;

- adjust the spacing following the field review, as necessary; and
- determine the final inlet locations at the Design Field Review.

For detailed information on drainage design, see [Chapter 29](#).

33.2.6 Right of Way Control

The Design Field Review Plans should show the approximate new right of way line and control of access lines, if applicable. Place the control of access lines just inside the new right of way line. If no control of access lines are shown, then it is understood that access to the highway by the adjoining property owners is permitted. For detailed information on right of way procedures, see [Chapter 30](#).

33.2.7 Typical Sections

The Design Field Review Typical Sections will be the same as those shown in the Project Planning Report. The Typical Sections at this stage will only provide enough information to reflect the project's roadway elements. For example, a detailed dimension of pavement composition is not necessary at this stage. For more information on Typical Sections, see [Section 34.2.4](#).

33.2.8 Cross Sections

The Design Field Review Plans include the development of cross sections for all critical sections along the project corridor. Critical cross sections can help to identify the following:

- areas where adjustments to the alignment and/or profile are possible to eliminate the need for acquisition of buildings or other expensive developments by determining toe of slope limits;
- locations where minor changes in the horizontal or vertical geometry may have major beneficial effects on earthwork quantities; and
- the need, height and length of any necessary retaining walls.

For more detailed information on cross sections, see [Section 34.2.18](#).

33.2.9 Intersection Details

Design Field Review Intersection Plans should be in graphical format at a scale commensurate with project complexity. The Plans should show the roadway intersection angle, number of lanes and pavement width of all legs of the intersection including proposed taper, lengths for turning lanes and proposed radii for curb or edge of pavements. For major intersections, provide a schematic of the design traffic turning volumes on the Title Sheet or Plan and Profile Sheets, as appropriate. Sidewalk locations are shown graphically on the Plan Sheets.

All elements of the intersection should be shown on a plan sheet so that the entire improvement can be reviewed by observing the overall layout. This may be accomplished by changing the scale of the drawing or making a composite drawing from two or more sheets.

For more detail on intersection design criteria, see [Chapter 15](#).

33.2.10 Interchanges

Due to the complexity of interchanges, each interchange along the proposed project corridor should have a separate Interchange Plan Sheet. Provide the following interchange details in the Design Field Review Plans:

- a graphic geometric layout of all ramps;
- the horizontal geometry for the mainline, crossroads and ramps;
- locations of grade separation structures; and
- a traffic schematic showing the future design hourly traffic volumes for all ramps.

Show proposed contours, to the extent they reflect the intended grading scheme, sight distance, earthwork, drainage systems, etc., that may affect the preparation of the Right of Way Plans.

Once a schematic of the proposed interchange improvements is developed, submit it to the Traffic Engineering Division for the development of a preliminary Signing Plan.

For more detailed information on interchanges, see [Chapter 16](#).

33.2.11 Other Design Elements

Other design elements that should be addressed in the Design Field Review Plans include:

- median openings,
- sidewalks,
- curb and gutters,
- utilities,
- hazardous materials, and
- detours.

33.2.12 Design Field Review

The purpose of the Design File Review is to review the geometric design to insure the project is meeting the proposed scope before the geostructural and hydraulic designs are initiated. The Design Group Coordinator will provide all representatives of the project development team, and any other applicable Units or agencies, a copy of the Design Field Review Plans for their own independent review. Complex projects may require more than one Design Field Review. Once approval of the Design Field Review is completed, the Program Manager submits the Plans to the Road Design Group to prepare the Right of Way Plans. The applicable Road Design Group is responsible for compiling all roadway comments from the Design Field Review for incorporation into the Construction Plans.

Following the incorporation of Design Field Review comments into the Design Field Review Plans, the Road Design Group retains the official Design Field Review prints. The Design Field Review prints are to accompany the Final Construction Plans when the latter are submitted for signatures.

33.3 RIGHT OF WAY PLANS (70 PERCENT)

The Right of Way Plans advance the Design Field Review Plans to a point that all other Units can complete their work. This includes incorporating existing topographic and property features that accurately represent the extent of natural and manmade conditions within and adjacent to the project corridor including estimated surface and underground features.

33.3.1 Drainage

Drainage studies must be sufficiently complete to depict the planned drainage improvements affecting the proposed project (e.g., drainage patterns and features, structures and outfall ditch work). The Right of Way Plans should depict the proposed drainage patterns and features accurately because they impact property values.

Show drainage structures (e.g., bridge vs. box culvert), ditches/channels, conveyance of storm drainage at side roads and driveways and clean out requirements of transverse ditches/streams on the Plans. Finite data (e.g., lengths of pipe, ultimate pipe elevations) may be omitted from the drawings because these values may change slightly during the final stages of design. The Right of Way Plans should also show the limits of existing and proposed outfall ditch work and which methods are used to accomplish the work (e.g., obtaining permission, acquiring new right of way).

The Hydraulic Engineering Section is responsible for the design of major crossings and median drainage systems; their design should take into consideration comments received during the Design Field Review. The Hydraulic Engineering Section also designs cross and parallel storm drainage systems for curb and gutter sections. The Road Design Group incorporates the Hydraulic Engineering Section's drainage design into the Plans.

33.3.2 Environmental

The Program Manager initiates the environmental process by submitting the Project Planning Report and the Design Field Review Plans to the Environmental Management Office. [Chapter 27](#) summarizes the environmental procedures required for roadway projects.

33.3.3 Right of Way

The right of way requirements are determined by plotting the construction limits. The designer typically establishes a new right of way line outside of the construction limits. The locations of new right of way limits should be evaluated in depth at the Design Field Review and adjusted as required by conditions. In some cases (e.g., congested urban

areas), the right of way line is set a minimum of one foot from the back edge of the sidewalk; slopes that extend beyond these limits are acquired by slope permission agreements obtained by the Right of Way Office.

For major projects, the completed Right of Way Plans should depict the entire parcel of property affected by the proposed acquisition. This may be achieved on the plan and profile sheets, supplemental reduced scale plots of entire property boundaries on separate sheets, or a combination of the above. Accurate representation of existing development is essential for proper appraisals and negotiations of acquiring additional right of way.

33.3.4 Cross Sections

Cross sections are developed to the extent that construction limits can be determined for the establishment of the new right of way limits. Cross sections for Right of Way Plans should show the location of the existing ground along with the final roadway template. Include the following on the cross sections:

- the finished roadway surface with the appropriate cross slopes (e.g., normal crown, fully or partially superelevated) and the top of subgrade;
- approximate limits of the removal of unsuitable material, as necessary;
- the location of parallel and cross drainage structures on the appropriate cross sections as necessary (e.g., skewed cross drainage may require the development of a skewed section by interpolating between adjacent cross sections);
- locations of pertinent structures, including footings and/or foundations; and
- the location of existing right of way along with the location of the new right of way.

33.3.5 Bridge Plans

The Bridge Design Section establishes the preliminary type, size and location of project structures as well as loadings, span arrangements and lengths of individual spans. Based on the Right of Way Plans, the Bridge Design Section will begin the preparation of the Bridge Plans. The Road Design Group uses the bridge depths provided by the Bridge Design Section to finalize grades in order to provide the proper vertical clearances. Hydraulic data (e.g., design storm, high-water elevation, water velocity) and need for scour protection are shown on the plans in addition to the vertical and horizontal clearances.

33.3.6 Minor Structures

Right of Way Plans should show other minor structures (e.g., retaining walls, noise barriers) in the plan and cross section views. Show all information on the Plans that depict the intent of the improvements.

Show any required additional right of way for overhead sign structure footings, signal footings and conventional signing.

33.3.7 Railroads

The Design Field Review Plans should identify the railroad companies that have facilities in the project area and whether any railroad crossings are to be at-grade or grade-separated structures. All work on railroad right of way must be approved by the railroad and is coordinated through the Utilities Office.

33.3.8 Intersections

In coordination with the Traffic Engineering Division, intersection details should include all of the elements of the intersection design criteria as described in [Chapter 15](#). All pertinent geometry from the Design Field Review Plans should be tied by station and offset. Preliminary intersection data originally shown graphically should now be shown dimensioned to establish exact widths, offsets, transition lengths, curve radii, curve delta angles, and PC, PT and PCC stations. The layout should also show locations and dimensions of all proposed paved islands and lengths for left- and right-turn lanes.

33.3.9 Interchanges

Interchange Plans should show all of the necessary geometry to define and to ascertain right of way limits with respect to the geometric ties to other roadways within the interchange area. They should include all of the dimensions identifying pavement widths, pavement transition locations, and pavement gore width and locations. These plans should contain a profile for each individual interchange ramp. At this stage, the Plans should:

- identify the station and offset ties to the main roadways at locations where they depart and merge with the interchanging main roadways;
- show the edge of mainline traveled way from the beginning or ending of the taper to the location of the gore between mainline and ramp; and
- show completed contours that reflect the grading scheme, sight distance, earthwork, drainage systems, etc.

33.3.10 Construction Limits

The Right of Way Plans should show the construction limits in the plan view for each cross section location. Show the construction limits adjacent to interchange ramps, crossroads and parallel drainage courses. In certain cases, it may be desirable to show dual construction limits for clarification purposes. [Figure 33-3A](#) provides an example of dual construction limits.

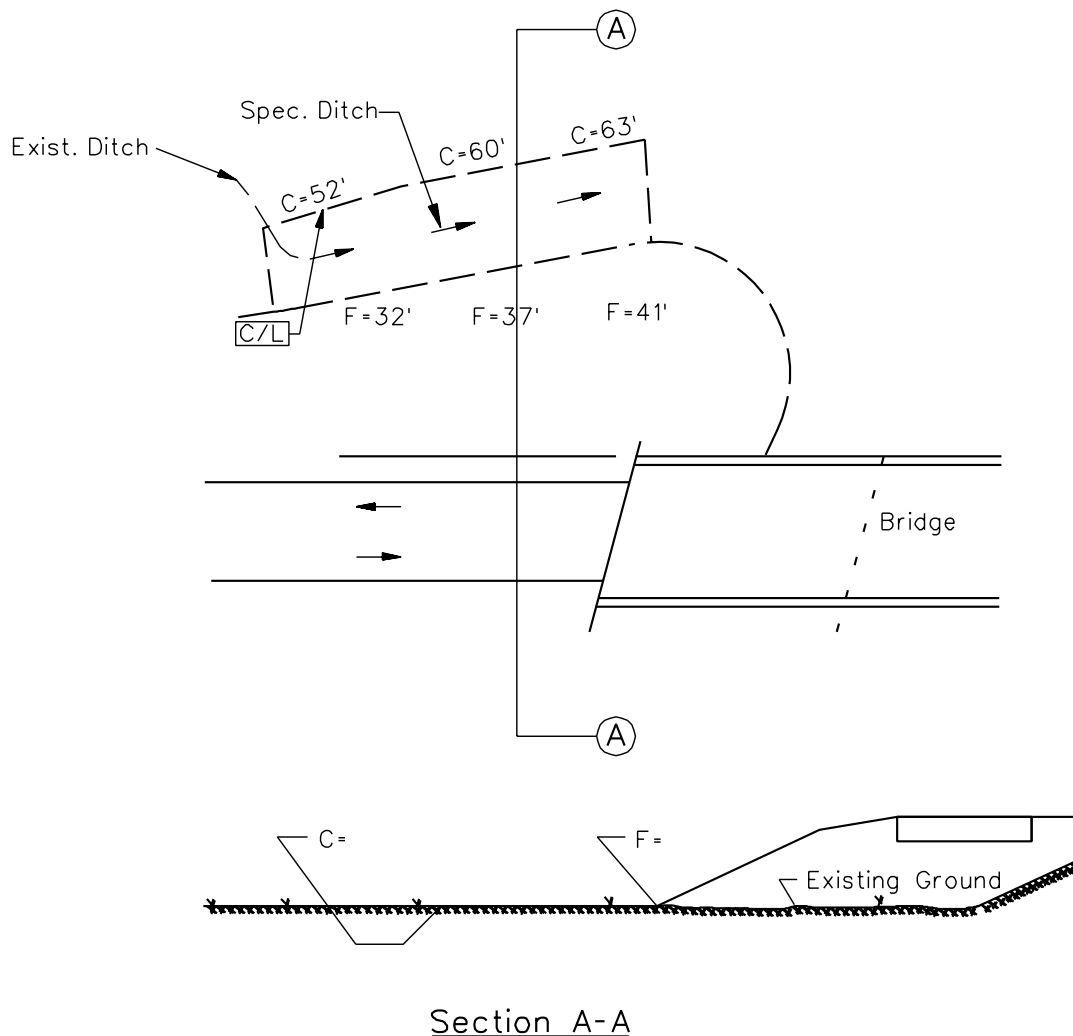

DUAL CONSTRUCTION LIMITS

Figure 33.3A

33.3.11 Right of Way Limits

The Right of Way Plans should conform to the standard practices and procedures outlined in [Chapter 30](#). Generally, show existing right of way graphically and new right of way limits by station and offset. Show the labels at the beginning and ending of each plan sheet and on each side of the roadway. Identify all points of access control beginning and ending with proper stationing.

33.3.12 Detours

If detours are deemed necessary for highway constructability, they should be developed during the preparation of the Right of Way Plans. The designer should establish and document the work limits on the drawings. Clearly show the permission to construct, maintain and remove on the Right of Way and Construction Plans.

If existing routes are used for detouring traffic during the construction stages, the Traffic Engineering Division, in consultation with Maintenance personnel, will decide if the detour should be handled by the Department or by the contractor.

33.3.13 Restoration of Construction Slopes in Urban and/or Residential Locations

When developing Right of Way Plans in areas of concentrated residences, insure required items of LIKE KIND seeding and/or sodding are included to properly restore established lawns to their preconstruction status. This information should have been obtained during the Design Field Review. No additional considerations or compensation will be considered for restoring lawns during the Right of Way Plans Phase.

33.4 FINAL CONSTRUCTION PLANS (90 PERCENT)

The Final Construction Plans are used for obtaining final approvals, construction permits and for showing actual construction details. These plans should be in sufficient detail to resolve all design problems. The type and extent of work proposed dictates the disciplines involved in this review process.

At the end of this task, all plan sheets, except the Summary of Estimated Quantities Sheet, quantities and estimates should be essentially complete. [Chapter 34](#) provides the layout requirements and format of each individual sheet in the Final Construction Plans.

33.4.1 Title Sheet

The Final Construction Plans Title Sheet is developed to reflect the proposed work represented by the plan drawings. This sheet may differ from the Right of Way Plan Title Sheet (e.g., sheet numbering, sheet indexing, project mileage).

Use the signed Title Sheet from the Right of Way Plans to develop the Title Sheet for the Final Construction Plans. Occasionally, Right of Way Plans are developed for the entire project while the Construction Plans are developed for the same project in phases. If this occurs, it is important that the original right of way plan sheets are cross referenced to the new sheet numbers assigned to the construction plan sheets. Show the cross referencing immediately below the plan reference box in the upper, right-hand corner of each sheet.

33.4.2 Revisions

If a revision is necessary during the development of the Final Construction Plans that may affect the designs or work of another Unit (e.g., Bridge Design Section, Traffic Engineering Division, Right of Way Office), notify the applicable Unit immediately and furnish them with the revised sheets.

33.5 FINAL CONSTRUCTION PLANS (100 PERCENT)

33.5.1 Purpose

The Final Construction Plans are a collection of all the design plans from all the applicable Units (e.g., Road, Traffic, Bridge). After they are reviewed, approved and signed by the applicable individuals, they are forwarded to the Contracts Administration Section for letting and ultimately to the contractor for construction. [Chapter 37](#) provides the procedures for preparing the Final Construction Plans for letting.

The Final Construction Plans incorporate all of the amendments or revisions evolving from the final roadway plan review. Additionally, the designer will complete all of the quantity tables and identify any Special Provisions necessary for the construction of the project. The designer should review all right of way Special Provisions to insure that all commitments made during right of way negotiations are incorporated into the Plans and/or Special Provisions, as appropriate.

33.5.2 Distribution

[Figure 33.5A](#) provides the distribution list for the initial Final Construction Plans submission. [Figure 33.5B](#) provides the distribution list for the revised plan sheets if there are revisions to the plan sheets after the initial submission.

Project Type	Plans Distribution to Other Sections of SCDOT		
	Right of Way Office	Utilities Office	District Engineer
Federal Project within a City or Town	4 Large Sets with Cross Sections 3 Large Sets without Cross Sections 2 Small Sets with Cross Sections 3 Small Sets without Cross Sections	1 Large Set with Cross Sections	1 Large Set without Cross Sections
Federal Project <u>not</u> within a City or Town	3 Large Sets with Cross Sections 3 Large Sets without Cross Sections 2 Small Sets with Cross Sections 2 Small Sets without Cross Sections	1 Large Set with Cross Sections	1 Large Set without Cross Sections
"C" or Secondary Project within a City or Town	3 Large Sets with Cross Sections 3 Large Sets without Cross Sections 1 Small Set with Cross Sections 2 Small Sets without Cross Sections	1 Large Set with Cross Sections	1 Large Set without Cross Sections
"C" or Secondary Project <u>not</u> within a City or Town	2 Large Sets with Cross Sections 2 Large Sets without Cross Sections 1 Small Set with Cross Sections 1 Small Set without Cross Sections	1 Large Set with Cross Sections	1 Large Set without Cross Sections

Notes:

1. *Replace the original Title Sheet in the Plans with a copy and send the original Title Sheet to the Right of Way Office to obtain any necessary town or city council signatures.*
2. *Insure all signatures and initials required on the Title Sheet are obtained before the initial submission.*
3. *Distribute one small copy without the cross sections to FHWA in accordance with SCDOT's "Dates for Assembling Information on Construction Obligations" for projects with FHWA oversight.*

**PLANS DISTRIBUTION LIST
(Initial Submission)**

Figure 33.5A

Project Type	Plans Distribution to Other Sections of SCDOT
	Right of Way Office
Federal Project within a City or Town	7 Large Sets of Revised Sheets 5 Small Sets of Revised Sheets
Federal Project <u>not</u> within a City or Town	6 Large Sets of Revised Sheets 4 Small Sets of Revised Sheets
"C" or Secondary Project within a City or Town	6 Large Sets of Revised Sheets 3 Small Sets of Revised Sheets
"C" or Secondary Project <u>not</u> within a City or Town	4 Large Sets of Revised Sheets 2 Small Sets of Revised Sheets

**PLANS DISTRIBUTION LIST
(Revised Sheets)**

Figure 33.5B

33.6 CONSTRUCTION PHASE

33.6.1 Construction Plans Storage

The Final Construction Plans are filed with the Plans Storage Group within the Road Design Section and are to be kept in permanent storage. They are only revised to reflect major changes that occurred during construction.

33.6.2 Final As-Built Plans

During construction of the project, the Resident Construction Engineer maintains a separate set of drawings on which all revisions to the plans on the project are recorded. These plans, when checked and completed, are transmitted to the Final Construction Plans Manager in the Central Office (Columbia) where they are kept for permanent record.

33.6.3 Plan Revisions and Construction Changes

33.6.3.1 Revised Plan Sheets

Use the following procedures to make revisions to the plan sheets after they are submitted to the Operations Center:

1. Changes Prior to Letting. Changes to plan sheets that are made available to the bidders prior to the highway letting will be reviewed by the responsible Road Design Group, who will verify that all changes have been made in the CADD files. Revised plan sheets will be provided to the Engineering Reproduction Manager who will incorporate the revised sheets into the plans after the letting date.
2. Changes After Letting. Revised plan sheets that are not available to the bidders prior to the letting will not be added to the Bid Plans at any time. These revised sheets will be handled by the Construction Division and will be added to the As-Built Plans when construction is completed. This procedure is for all revisions made after the letting or when the revisions cannot be made available to the prospective bidders prior to letting. The Road Design Group labels any additional or revised plan sheets provided with ½-inch bold letters under the box in the upper, right-hand corner, CONSTRUCTION CHANGE-SHEET PROVIDED AFTER LETTING. If no space is available under the box, then any location near the box is acceptable. These sheets will not be added to the Bid Plans, but will be placed face up in the back of the stored plans for reference. Revised and added plan sheets during the construction phase will be incorporated into the final As-Built Plans after construction is completed. [Figure 33.6A](#) provides a distribution list for revised plans sheets after the contract has been awarded.

Project Type	Plans Distribution to Other Sections of SCDOT	
	Right of Way Office *	Construction Division
Federal Project within a City or Town	7 Large Sets of Revised Sheets 5 Small Sets of Revised Sheets	6 Large Sets of Revised Sheets 3 Small Sets of Revised Sheets
Federal Project <u>not</u> within a City or Town	6 Large Sets of Revised Sheets 4 Small Sets of Revised Sheets	6 Large Sets of Revised Sheets 3 Small Sets of Revised Sheets
"C" or Secondary Project within a City or Town	6 Large Sets of Revised Sheets 3 Small Sets of Revised Sheets	6 Large Sets of Revised Sheets 3 Small Sets of Revised Sheets
"C" or Secondary Project <u>not</u> within a City or Town	4 Large Sets of Revised Sheets 2 Small Sets of Revised Sheets	6 Large Sets of Revised Sheets 3 Small Sets of Revised Sheets

* Only submit these plan sets if the plan revision affects the right of way.

PLANS DISTRIBUTION LIST

Figure 33.6A

33.6.3.2 Working Plans

Working Plans requested by District personnel include all revised sheets in the proper order with the old sheets removed. The Engineering Reproduction Manager will maintain a complete copy of the Working Plans and will provide copies to Department employees when specifically requested. The Engineering Reproduction Manager will mark the Plans with WORKING PLANS and with the date of printing. The Plans are clearly marked to avoid confusing these plans with the Bid Plans or the final As-Built Plans.

33.6.3.3 Title Sheet and Estimated Quantity Revisions

Any plan sheet may be revised except for the Title Sheet. If the Title Sheet needs to be changed, see the Operation's Manager within the Road Design Section.

Show revised quantities on a revised Summary of Estimated Quantities Sheet. The original quantities must not be changed. Add a note to the Quantity Sheet describing which plan sheets are affected by the change or additional work.

The Road Design's Engineering Reproduction Manager will archive all plan sheets, original and revised, on the appropriate Department's server. The Road Design's CADD Support Manager will archive all design files, including the revisions.

33.7 PUBLIC ACCESS TO PLANS

All Construction Plans and support drawings may be viewed at the Department anytime during project development.

33.7.1 Public Hearing/Meeting Plans

During the development stages of a project, it may be necessary to inform the public of the proposed project plans. This is achieved, in part, through the use of the following:

- maps,
- displays,
- sketches,
- renderings,
- photographs,
- preliminary and advanced plan drawings,
- project scoping meetings,
- public informational meetings,
- corridor public hearings,
- location and design hearings, and/or
- other similar meetings involving the public.

The degree of project development will generally dictate the types of displays required and the type of hearings/public meetings needed. The public may view these materials in the Department at any time.

The public hearing/meeting plans are a valuable set of documents in that they represent to the public the Department's planned improvements. They are to be retained for a minimum of three years after construction completion.

Any plan sheets provided to individuals and/or agencies following the public hearing will be stamped PRELIMINARY – FOR INFORMATION ONLY. They will be so marked until the Plans are let for construction.

33.7.2 Document Fees

All requests for copies of the plan sheets for projects that have been awarded are made through the Plans Storage Group and require payment in advance by check or cash. All requests for copies of plan sheets brought to the Engineering Reproduction Service by Department personnel for Department use are provided to the Department employee at no charge. Copies of the plans for bidding purposes are obtained from Engineering Publication Customer Service Center.

A Schedule of Fees for Department publications is available from the Department. All transactions require payment in advance. There are no credit transactions of any kind. Copies of plan sheets requested by any government agency are provided at no charge. However, additional copies to the same government agency are paid for in accordance with the Schedule of Fees. Fees for special requests, large orders and other documents for government agencies will be determined on a case-by-case basis.

Table of Contents

<u>Section</u>	<u>Page</u>
34.1 GENERAL	34.1(1)
34.1.1 Drafting Guidelines	34.1(1)
34.1.1.1 Computerized Drafting	34.1(1)
34.1.1.2 MicroStation	34.1(2)
34.1.1.3 GEOPAK	34.1(2)
34.1.1.4 Internet	34.1(2)
34.1.1.5 Project Data File Storage	34.1(2)
34.1.1.6 File Backup	34.1(3)
34.1.2 Sheet Sizes	34.1(3)
34.1.3 Standard/General Construction Notes	34.1(3)
34.1.4 Abbreviations	34.1(3)
34.1.5 Sheet Organization	34.1(8)
34.2 CONSTRUCTION PLAN SHEET CONTENT	34.2(1)
34.2.1 Plan Cover	34.2(1)
34.2.2 Title Sheet (Sheets 1, 1A, etc.)	34.2(1)
34.2.3 Summary of Estimated Quantities, Removal and Disposal Items, Reset/New Fence Sheets, etc. (Sheets 2, 2A, etc.)	34.2(2)
34.2.3.1 Roadway Summary of Estimated Quantities Sheet ...	34.2(2)
34.2.3.1.1 Trns•port	34.2(2)
34.2.3.1.2 Rounding	34.2(3)
34.2.3.1.3 Revisions	34.2(3)
34.2.3.1.4 Structures	34.2(4)
34.2.3.1.5 Pavement Marking, Lighting, Signing and Traffic Signals	34.2(4)
34.2.3.2 Removal and Disposal Items, Moving Items, Reset/ New Fence Sheets	34.2(4)
34.2.3.2.1 Submissions	34.2(4)
34.2.3.2.2 Item Number	34.2(6)
34.2.3.2.3 Underground Storage Tanks	34.2(6)
34.2.3.2.4 Description and Work To Be Done	34.2(6)
34.2.4 Typical Section Sheets and Miscellaneous Details (Sheets 3, 3A, etc.)	34.2(7)

Table of Contents
(Continued)

Section	Page
34.2.4.1	Scale 34.2(7)
34.2.4.2	Dimensions 34.2(7)
34.2.4.3	Identification of Materials and Application Rates 34.2(7)
34.2.4.4	Station Limits 34.2(8)
34.2.4.5	Clarification Notes 34.2(8)
34.2.4.6	Partial Sections and Blow-ups 34.2(8)
34.2.4.7	Curb (Disabled) Ramps 34.2(8)
34.2.4.8	Design Speed and Exceptions 34.2(8)
34.2.4.9	“C” Project Road Group Designation 34.2(9)
34.2.4.10	Special Details 34.2(9)
34.2.4.11	Superelevation Layouts 34.2(9)
34.2.4.12	Miscellaneous Details (Special Drawings) 34.2(9)
34.2.5	Right of Way Data Sheets, Property Strip Map, Traffic Data Sheets (Sheets 4, 4A, etc.) 34.2(10)
34.2.5.1	Right of Way Data Sheet 34.2(13)
34.2.5.2	Property Strip Map 34.2(13)
34.2.5.3	Property Revisions 34.2(14)
34.2.6	General Construction Sheets (Sheets 5, 5A, etc.) 34.2(14)
34.2.6.1	Plan Sheet Layout 34.2(14)
34.2.6.2	General Construction Notes 34.2(14)
34.2.6.3	Reference Data Sheets 34.2(15)
34.2.6.4	Utility Data Sheet 34.2(15)
34.2.6.5	Drainage Data Sheet 34.2(15)
34.2.7	Plan and Profile Sheets (Sheets 6, 7, 8, etc.) 34.2(15)
34.2.7.1	Topographic Features 34.2(16)
34.2.7.2	Right of Way and Property Features 34.2(16)
34.2.7.3	Existing Utilities 34.2(16)
34.2.7.4	Horizontal and Vertical Alignments 34.2(16)
	34.2.7.4.1 Coordinate System 34.2(17)
	34.2.7.4.2 Horizontal Alignment 34.2(17)
	34.2.7.4.3 Vertical Alignment 34.2(18)
34.2.7.5	Travel Lane Lines 34.2(19)
34.2.7.6	Proposed Roadway Features 34.2(19)

Table of Contents
(Continued)

Section	Page
34.2.7.7 Construction Limits.....	34.2(19)
34.2.7.8 National Pollutant Discharge Elimination System (NPDES) Lines.....	34.2(19)
34.2.7.9 Drainage Improvements.....	34.2(20)
34.2.7.10 Existing Ground (Pavement) Line.....	34.2(20)
34.2.7.11 Earthwork Balance.....	34.2(21)
34.2.7.12 Environmental Considerations.....	34.2(21)
34.2.7.13 Traffic Information.....	34.2(21)
34.2.7.14 Railroad Topography.....	34.2(21)
34.2.7.15 Profile Sheets (Sheets 6A, 7A, etc.).....	34.2(21)
34.2.7.16 Drainage and Utility Plan Sheets (Sheets D1, D2, etc.).....	34.2(22)
34.2.7.17 Miscellaneous Items.....	34.2(22)
34.2.8 Details of Plan Sheets (Sheets 12, 13, etc.).....	34.2(22)
34.2.8.1 Top of Curb Profiles.....	34.2(22)
34.2.8.2 Interchange Layout Sheets.....	34.2(23)
34.2.8.3 Staking Plan Sheet.....	34.2(24)
34.2.9 Sequence of Construction and Traffic Control Plan (Sheets TC1, TC2, etc.).....	34.2(24)
34.2.9.1 Work Zone Traffic Control Sheets.....	34.2(24)
34.2.9.2 Work Zone Traffic Control.....	34.2(24)
34.2.9.3 Detour Plans.....	34.2(25)
34.2.9.4 Work Zone Control Plan and Detours.....	34.2(25)
34.2.10 Electrical and Lighting Plans (Sheets E1, E2, etc.).....	34.2(26)
34.2.11 Landscaping Plans (Sheets L1, L2, etc.).....	34.2(26)
34.2.12 Pavement Marking Plans (Sheets PM1, PM2, etc.).....	34.2(26)
34.2.13 Signing Plans (Sheets SN1, SN2, etc.).....	34.2(27)
34.2.14 Traffic Signal Plans (Sheets TS1, TS2, etc.).....	34.2(27)
34.2.15 Roadway Structure Plans (Sheets S1, S2, etc.).....	34.2(27)
34.2.15.1 Drainage Structures.....	34.2(28)
34.2.15.2 Other Structures.....	34.2(29)
34.2.16 Erosion Control (EC1, EC2, etc.).....	34.2(29)
34.2.17 Utility/Utility Relocation Sheets (Sheets U1, U2, etc.).....	34.2(30)
34.2.18 Cross Sections (Sheets X1, X2, etc.).....	34.2(30)

Table of Contents
(Continued)

Section	Page
34.2.18.1 General	34.2(30)
34.2.18.2 Existing Ground Lines	34.2(30)
34.2.18.3 Proposed Template	34.2(32)
34.2.18.4 End Areas and Volumes.....	34.2(32)
34.2.18.5 Clarification Data	34.2(32)
 34.2.19 Bridge Plans (Sheets BR1, BR2, etc.).....	 34.2(32)

Chapter Thirty-Four

PLAN DEVELOPMENT

34.1 GENERAL

The accompanying chapters in the *SCDOT Highway Design Manual* provide the designer with uniform criteria and procedures for the geometric design of a highway facility. These designs must be incorporated into the Construction Plans so that they can be clearly understood by contractors, material suppliers and Department personnel assigned to supervise and inspect the construction of the project. To insure a consistent interpretation of the Construction Plans, individual sheets should have a standard format and content, and the sequence of plan assembly should generally be the same. Therefore, guidelines have been established for the uniform preparation of Construction Plans including, drafting guidelines, recommended plan sequence, plan sheet content and sample plan sheets.

A certain degree of discretion must be exercised in the development of plans. Simple projects may include additional details on the basic plan and profile drawings, and more complex projects may require separate “Special Drawings” in the final product.

Any major deviations from the instructions contained in this Chapter should be coordinated with the designer’s supervisor.

34.1.1 Drafting Guidelines

34.1.1.1 Computerized Drafting

Computers have significantly changed the Department’s mode of preparation for its highway plans. Computers have assumed the tedious tasks of drawing cross sections, plotting mass diagrams, calculating grading quantities, etc. They also allow the designer the freedom to develop and evaluate alternatives. However, they require the designer to be well versed in complex software.

The Department’s project drafting is performed by Computer-Aided Drafting and Design (CADD). All CADD work must be developed using MicroStation and GEOPAK software. For more information on CADD symbols, line styles and CADD cells used by the Department, see the *Road Design CADD Users Guide*. The *Road Design CADD Users Guide* can be viewed at the Department’s website.

The following Sections provide information on the design software, drafting criteria and the CADD file management used by the Department to prepare its Construction Plans.

34.1.1.2 MicroStation

SCDOT has selected MicroStation for its Department-wide computer-aided drafting and design software package, which is used for the drafting of Construction Plans. Using MicroStation's levels and reference files allows various users within the Department to work on the same set of plans without interfering with each other's design work (e.g., Right of Way, Traffic Engineering). By integrating or linking MicroStation with other software packages (e.g., GEOPAK, databases), the designer can use the computer to perform the actual design and layout of a project. MicroStation allows the user to select an unlimited number of levels to input data. The *Road Design CADD Users Guide* provides the guidelines on what type of information should be provided on each level. Because other Department Sections involved in the project planning process use the information contained on these levels, inputting data on the correct level is essential. Presenting the project data on different levels allows the user to see or print only the desired data by turning on or off the various levels. If problems or questions occur when using the software, the user should contact the CADD Support Unit.

34.1.1.3 GEOPAK

GEOPAK is a comprehensive, proprietary roadway design package that works as an interactive program within MicroStation. GEOPAK allows the designer to lay out design centerlines and profiles, calculate superelevation, generate cross sections, compute quantities, generate mass diagrams, complete plan labeling, and more. By providing GEOPAK with the minimum and maximum design criteria and other design control points, the designer can command the software to generate all line work for plan views, profiles and cross sections. GEOPAK can also be used to produce 3D model images of the design. Although GEOPAK can generate most roadway quantities, the designer must insure that the appropriate symbols, cells and the Department's rounding criteria are used. For more information on GEOPAK, the designer should review the *SCDOT GEOPAK User's Manual* or contact the CADD Support Unit or the manufacturer.

34.1.1.4 Internet

SCDOT provides various road design resources online at the Department's website. All Instructional Bulletins, Supplemental Specifications, *SCDOT Standard Drawings*, Pay Items and CADD design files can be viewed at this website.

34.1.1.5 Project Data File Storage

All projects are stored on the Department's file servers. Each Design Group is provided with sufficient disk space to store every design project completed by the Group. The Surveys Office is responsible for creating a project folder (i.e., directory) on the server using the PIN number and inputting all survey data and CADD files. Once the survey

data has been inputted, the Road Design Operations Manager notifies the assigned Design Group that they can begin the design process on that particular project.

34.1.1.6 File Backup

It is the Design Group's responsibility to backup their work to the file servers everyday. Only those files that are changed need to be backed up to the server. Every Design Group user has a unique login ID used to access the Department's computers and servers. Passwords for the user ID should not be shared with other users outside of the Design Group or the Department.

34.1.2 Sheet Sizes

The Department currently uses a D size (i.e., 36 inches x 22 inches) as the standard paper size during project development. This paper size is used for all Final Plans. Where deemed necessary, this size may also be used for preliminary design reviews (e.g., for complex drawings).

34.1.3 Standard/General Construction Notes

For guidance on the typical notes placed on the various plan sheets, see the *Road Design Plan Preparation Guide*.

34.1.4 Abbreviations

There are recognized abbreviations commonly used in the drafting of highway plans. [Figure 34.1A](#) contains an alphabetical listing of the abbreviations that are to be used in preparation of highway plans for the Department. Acronyms that commonly appear on the drawings are also included in this alphabetical listing.

<u>DESIGNATION</u>	<u>ABBREVIATION</u>	<u>DESIGNATION</u>	<u>ABBREVIATION</u>
	-A-	Center	Ctr.
Abandoned	Abd.	Centerline	C/L or \mathcal{C}
Abutment	Abut.	Chord	Chd.
Acre	Ac.	Church	Ch.
Addition	Add.	Circle	Cir.
Adjust	Adj.	Circumference	Cir.
Aggregate	Agg.	Clean Out	C.O.
Ahead	Ah.	Company	Co.
Alternate or Alternative	Alt.	Concrete	Conc.
Angle	Ang.	Connection	Conn.
Apartment	Apt.	Construction	Const.
Approach	Appr.	Controlled Access	CA or C/A
Approximate	Approx.	Corner	Cor.
Asphalt	Asph.	Corrugated Aluminum Alloy	CAA
Auxiliary	Aux.	Corrugated Metal Pipe	CMP
Avenue	Ave.	Corrugated Polyethylene	Corr. P.E.
Average	Avg.	County	Co.
Average Annual Daily Traffic	AADT	Creek	Ck.
Average Daily Traffic	ADT	Cross Section	X-Sect.
Azimuth	Az.	Cubic Feet (Foot)	CF
	-B-	Cubic Feet Per Second	CFS
Back	Bk.	Cubic Yard	CY
Baseline	B/L	Culvert	Culv.
Backsight	BS	Curb and Gutter	C & G
Basement	Bsm't		-D-
Bearing	Brg.	Decimal	Dec.
Benchmark	B.M.	Degree	Deg. or ($^{\circ}$)
Bituminous	Bit.	Delta	Δ
Block	Blk.	Department	Dept.
Book	Bk.	Design	Dgn.
Borrow	Bor.	Design Hourly Volume	DHV
Boulevard	Blvd.	Diagonal	Diag.
Brick	Br.	Diameter	Diam. or Φ
Building	Bldg.	Dimension	Dim.
Business	Bus.	Direction	Dir.
	-C-	Distance	Dist.
Cable Television	CATV	Drawing	Dwg.
Capacity	Cap.	Drive	Dr.
Cast Iron	C.I.	Ductile Iron	D.I.
Catch Basin	CB	Dwelling	Dwlg.
Cemetery	Cem.		-E-
		Each	Ea.
		Easement	Easm't

PLAN ABBREVIATIONS

Figure 34.1A

<u>DESIGNATION</u>	<u>ABBREVIATION</u>	<u>DESIGNATION</u>	<u>ABBREVIATION</u>
East	E.	Inside Diameter	ID
Edge of Pavement	EOP/EP	Invert	Inv.
Edge of Traveled Way	ETW	Iron Pin	IP
Elbow	Ell.	Iron Pin New	IN
Elevation	Elev.	Iron Pin Old	IO
Engineer	Engr.	Irrigation	Irrig.
End of Information	EOI		-J-
Equality or Equation	Eq.	Joint	Jt.
Estimate	Est.	Junction Box	JB
Excavation	Exc.		-L-
Existing	Exist.	Lateral	Lat.
Expansion	Exp.	Left	Lt.
External	E	Length of Curve	L
	-F-	Length of Tangent	T
Face of Curb	FOC/FC	Light Pole	LP
Face Curb to Face Curb	FC-FC	Linear Feet	LF
Feet or Foot	Ft. or '	Low Water	L.W.
Fiber Optic Line	FOL	Lump Sum	L.S.
Figure	Fig.		-M-
Fire Hydrant	FH	Manhole	M.H.
Feet Per Second	fps	Masonry	Mas.
Finished Grade	FG	Material	Mat'l
Flat Bottom	FB	Maximum	Max.
FlowLine	FL	Mean Low Water	MLW
Foresight	FS	Mean High Water	MHW
Frame	Fr.	Mean Sea Level	MSL
	-G-	Miles Per Hour	MPH
Gallon	Gal.	Minimum	Min.
Gallons Per Minute	GPM	Minute	Min. or (')
Garage	Gar.	Miscellaneous	Misc.
Gauge or Gage	Ga.	Monument	Mon.
Grade	Gr.		-N-
Guard Rail	GR	National Pollutant Discharge Elimination System	NPDES
	-H-	Necessary	Nec.
Headwall	Hdwl.	North	N.
High Point	H.P.	Not in Contact	N.I.C.
High Water	HW	Not to Scale	NTS
Highway	Hwy.	Number	No. or #
Horizontal	Horiz.		-O-
	-I-	On Center	O.C.
Inch	In. or "	Ordinary High Water	O.H.W.
Including	Inc.		

PLAN ABBREVIATIONS

Figure 34.1A (Continued)

DESIGNATION

-Y-

ABBREVIATION

Yard

Yd.

Year

Yr.

Yellow

Yel.

PLAN ABBREVIATIONS

Figure 34.1A (Continued)

34.1.5 Sheet Organization

Figure 34.1B provides plan sheet numbers that are assigned to certain drawings and a listing of additional drawings to be incorporated into each number set.

Most highway and bridge project plans are similar as far as their basic content. As the project is designed, drawings are organized systematically and much of the information required to produce the Construction Plans is similar. Some complex projects require additional detail, or more in-depth study or design, which results in additional drawings or data not common to most projects. In this case, the recommended procedure for drawing organization and sheet numbering in Figure 34.1B may require alteration. Alterations should be discussed with and approved by the designer's supervisor during the early planning stages.

If road profiles are shown on a separate sheet, the profile sheet should follow the corresponding plan sheet and be numbered as an "A" Sheet. For example, if Sheet 6 is the Plan Sheet, the next sheet, the Road Profile Sheet, would be Sheet 6A.

Only the Title Sheet contains the total plan sheet count. Show this number in the box in the upper right-hand corner of the Title Sheet. As the plan development process proceeds through Right of Way and Final Construction Plans, the number of plan sheets will change, and the number in this box will be revised accordingly.

Upon completion of the Construction Plans, the number shown in this box will reflect the sum of the subtotal sheet count as contained in the Index of Sheets.

Sheet Number	Description
1, 1A, etc.	Title Sheet
2, 2A, etc.	Summary of Estimated Quantities, Removal and Disposal Items, Moving Items, Reset/New Fences, etc.
3, 3A, etc.	Typical Sections and Miscellaneous Details (not covered by <i>Standard Drawings</i>)
4, 4A, etc.	Right of Way Data Sheet, Property Strip Map, Traffic Data Sheets
5, 5A, etc.	General Construction Sheets (e.g., Reference Data Sheets, Utility Data Sheets, Drainage Data Sheets, Plan Sheet Layout)
6, 7, 8, etc.	Plan and Profile Sheets (e.g., mainline, side roads, ramps)
6A, 7A, 8A, etc. *	Profile Sheets
D1, D2, D3, etc. *	Drainage Plan Sheets
12, 13, 14, etc.	Details of Plan Sheets, Geometric and Grading Plan for Intersections and Interchanges, Top of Curb Elevations (if not shown on Plan and Profile Sheets)
TC1, TC2, etc.	Traffic Control and Construction Phasing, Detour Plan and Profile Sheets
E1, E2, etc.	Electrical and Lighting Plans
L1, L2, etc.	Landscaping Plans
PM1, PM2, etc.	Pavement Marking Plans
SN1, SN2, etc.	Signing Plans
TS1, TS2, etc.	Traffic Signal Plans
S1, S2, etc.	Roadway Structure Plans (e.g., retaining walls, box culverts)
EC1, EC2, etc.	Erosion Control Data Sheets
U1, U2, etc.	Utility Relocation Sheets (For Information Only)
X1, X2, etc.	Cross Sections
BR1, BR2, etc. UC1, UC2, etc.	Bridge Plans Utility Construction Sheets

* Note that these sheets should only be used where the information cannot be combined with the Plan Sheet.

Revised: 10-2005

SHEET NUMBERING SYSTEM
Figure 34.1B

34.2 CONSTRUCTION PLAN SHEET CONTENT

The criteria discussed in this section for data presentation and content on drawings are intended to produce uniformity in the development of Construction Plans. The end result is a set of plans that is easy to organize, review, check and quantify. Following established procedures both reduces time and cost during the preparation of the Plans and ultimately facilitates the construction of projects.

The Plans should be prepared as simply as practical. Avoid the use of duplicated data and unnecessary cross references. This Section and the *Road Design Plan Preparation Guide* provide information on what should be included within each sheet of a set of Final Construction Plans. The *Road Design CADD Users Guide* provides information on text sizes, font types, symbols, cell libraries and drafting levels that should be used to develop a set of Construction Plans.

See the *Road Design Plan Preparation Guide* for additional guidance on the development of Construction Plan Sheets and Sample Plan Sheets.

34.2.1 Plan Cover

The purpose of a Plan Cover is for easy referencing to the project's general information and for filing accessibility. Blank Covers can be obtained from the Engineering Reproduction Services. The Plan Cover should display the county, file no., project no., route no. or road no., and the termini. This information should match the information on the Title Sheet.

34.2.2 Title Sheet (Sheets 1, 1A, etc.)

The Department has a standard master Title Sheet that is used on all roadway projects. The following information is contained on the base drawing:

- the Department's name and logo,
- Index of Sheets,
- location map and project mileage summary table,
- route title identification box,
- traffic data,
- signature approval boxes,
- longitude and latitude box,
- NPDES box,
- railroad involvement box,
- legend,
- north arrow,
- note referencing Bridge Plans,

- PUPS (Palmetto Utility Protection Service), and
- reference notes to the Department's *Standard Specifications* and *SCDOT Standard Drawings*.

Basic information may change for different projects and the designer needs to be aware of revisions in order to keep the project Title Sheet up to date.

34.2.3 Summary of Estimated Quantities, Removal and Disposal Items, Reset/New Fence Sheets, etc. (Sheets 2, 2A, etc.)

The Department has developed standard summary sheets for the development of all roadway projects. These are the Summary of Estimated Quantities, Removal and Disposal Items, and Reset/New Fence Sheets.

"C" projects with more than one road and the same PIN number may list the quantities separately but must have a total quantity column. "C" projects that have more than one PIN number bound together must have a total quantity column for each PIN number. Also, projects that are located in more than one county must have separate quantities for each county.

34.2.3.1 Roadway Summary of Estimated Quantities Sheet

The Roadway Summary of Estimated Quantities Sheet is discussed in the following Section. For guidance on developing quantities, see [Chapter 35](#).

34.2.3.1.1 Trns•port

Trns•port has been adopted by the Department as a means of analyzing bids on all projects under its jurisdiction. This system provides a process for assigning numbers to each bid (pay) item and is under the direction of the Road Design Engineer. The system requires all bid (pay) items to be coded by a seven-digit number (e.g., #7204100 – Concrete Sidewalk 4" Uniform). The first three digits of the numbering system refer to the particular section of the *SCDOT Standard Specifications for Highway Construction*. The last four digits of the numbering system are unique to a particular bid (pay) item.

Should the designer encounter a bid item for which a number has not been previously assigned, see [Section 35.1.3](#).

The designer should quantify those items applicable to their project. Care should be taken to identify all items by their assigned seven-digit number. Upon completion of the quantity listing, a final Summary of Estimated Quantities Sheet(s) is computer generated and incorporated into the Plans.

34.2.3.1.2 Rounding

On Roadway Summary Sheets, round all quantities to the nearest whole number in the unit column. However, still show the number to three decimals (i.e., 0.000). The following are the only exceptions to this procedure:

1. Station Grading. Compute and list to the tenth of a station.
2. Steel Beam Guardrail. Compute and list in multiples of 12.5 feet.
3. Removal of Existing Guard Rail. Compute and list to the nearest foot.
4. Concrete Median Barrier. Compute and list to the nearest foot.
5. Precast Concrete Risers. Compute in 16-inch increments and list to the hundredth of a foot.
6. Seeding. Compute and list to the thousandth of a square yard.
7. Fertilizer. Compute and list to the hundredth of a ton.
8. Lime. Compute and list to the hundredth of a ton.
9. Scarify, Mix, etc. Compute and list to the thousandth of a square yard.
10. Rumble Strips. Compute and list to the half of a mile.
11. Clear and Grub Material Pits. Compute and list to the tenth of an acre.
12. Class Concrete. Compute and list to the tenth of a cubic yard.
13. Signs (Construction and Permanent). Compute and list to the hundredth of a square foot.
14. Steel Posts for Signs (I-Beam). Compute and list to the hundredth of a foot.
15. U-Section Posts (Horizontal Bracing). Compute and list to the hundredth of a foot.
16. Bridge Rail (All Types). Compute and list to the tenth of a foot.

The letters NEC (necessary) are shown in the quantity column for all pay items where the standard unit of measurement is L.S. or lump sum.

34.2.3.1.3 Revisions

When revising plans that have already been let and awarded, provide a revised Summary of Estimated Quantities Sheet along with the revised plan sheet(s). [Figure](#)

34.2A provides an example of the note to be placed below the original quantities. Do not change the original quantities. The note should include the date of the revision and the sheet numbers of the revised sheets. The changes should be listed in the order as shown in Figure 34.2A, as applicable. An addition symbol (+) and subtraction symbol (-) depicts the quantities, as appropriate, on the Summary of Estimated Quantities Sheet.

Future revisions are placed beneath the previous revision. Additional Summary of Estimated Quantities Sheets may be added, if necessary.

34.2.3.1.4 Structures

Quantities for non-bridge structures are shown on the detail sheet. Final quantities itemized on the detail sheet are included on the Summary of Estimated Quantities Sheet.

34.2.3.1.5 Pavement Marking, Lighting, Signing and Traffic Signals

Because the Traffic Engineering Division is responsible for the design and development of Pavement Markings, Roadway and Bridge Lighting, Roadway and Bridge Signing, and Traffic Signal Plans, traffic control element quantities are developed by the Traffic Engineering Division and supplied to the road designer for incorporation in the final Summary of Estimated Quantities Sheet.

34.2.3.2 Removal and Disposal Items, Moving Items, Reset/New Fence Sheets

34.2.3.2.1 Submissions

The Right of Way Office provides a list of all items to be moved, removed and disposed of or reset during the construction of a project to the Road Design Engineer. This information is based on negotiations with the landowners.

Moving Items are submitted electronically on Form 995. Removal and Disposal Items are submitted on Form 995B. Fencing and UST quantities are submitted on Form 995C, except for decorative fencing such as picket, wrought iron, brick, etc. Decorative fencing should be included on the moving items list (i.e., Form 995).

It is especially important that data concerning septic tanks, drain fields, underground storage tanks or any other similar item be accurately obtained in order to insure these items are back filled during construction.

All projects requiring items of work involving demolition, moving and new or reset fence, are incorporated into these sub-summary sheets.

Item No	Pay Item	Quantity	Pay Unit
1031000	MOBILIZATION	NEC.	LS
1050800	CONST. STAKES, LINES & GRADES	1	EA
1071000	TRAFFIC CONTROL	NEC.	LS
1090200	AS-BUILT CONSTRUCTION PLANS	NEC.	LS
2012000	CLEAR & GRUB WITHIN RDWY.	NEC.	LS
2013050	CLEARING & GRUBBING DITCHES	0.500	ACRE
2031000	UNCLASSIFIED EXCAVATION	4165.000	CY
2033000	BORROW EXCAVATION	7797.000	CY
2034000	MUCK EXCAVATION	3717.000	CY
3050108	GRADED AGGR. BASE COURSE – 8" UNIF	10215.000	SY
3069900	MAINTENANCE STONE	50.000	TON
3103000	H/M ASPH. AGG. BASE CR. – TYPE 2	2746.000	TON
4010005	PRIME COAT	2759.000	GAL
4011004	LIQUID ASPHALT BINDER – PG64-22	232.000	TON
4013990	MILL EXIST ASPH. PVMT. – VARIABLE	2820.000	SY
4023000	H/M ASPH. CON. BINDER CR. – TYPE 2	991.000	TON
	Revised Pay Items – 07/24/03		
	Effected Sheets 4,6,7		
	Pay Items Revised	Adjustments to Quantities	
2034000	MUCK EXCAVATION	-500.000	CY
3069900	MAINTENANCE STONE	+25.000	TON
	Pay Items Deleted		
4013990	MILL EXIST ASPH. PVMT. – VARIABLE	-2820.000	SY
	Pay Items Added		
4031100	H/M ASPH. CONC. SURF. CR. – TYPE 1	+1013.000	TON

REVISED SUMMARY OF ESTIMATED QUANTITIES

Figure 34.2A

34.2.3.2.2 Item Number

The column designated “ITEM NO.” is used to designate a certain item. Each Item Number may contain more than one particular moving item. One Item Number should contain all moving items for each tract or property owner. This is also true for the Removal and Disposal Items.

If combining more than one “C” project item together in a set of plans, begin each item with Moving Item No. 1. If there is more than one road in an item, continue numbering the items concurrently. This also applies to Removal and Disposal Items.

Always leave a space between each Moving Item and Disposal Item, even if it requires more than one page.

34.2.3.2.3 Underground Storage Tanks

Underground Storage Tanks (UST) are set up as Removal and Disposal Items. They may be combined with other Removal and Disposal Items on the same tract, but must contain their own location (i.e., station number and offset Lt. or Rt.), accurate description (e.g., 10,000 GALLON KEROSENE TANK) and work to be done (e.g., REMOVE AND DISPOSE OF TANK ACCORDING TO DHEC REGULATIONS). If the locations of UST are known, they should be plotted on the plan sheets.

The right of way agent should provide any items regarding UST. Include the following UST items on the General Construction Notes as well as the Summary of Estimated Quantities Sheet:

- Removal and Disposal of Tank Contents,
- Removal and Disposal of Low Level Contaminated Soil, and
- Removal and Disposal of High Level Contaminated Soil.

See [Section 35.6.2](#) for additional guidance on UST.

34.2.3.2.4 Description and Work To Be Done

On the Moving Items and Removal and Disposal Sheets in the columns entitled “DESCRIPTION” and “WORK TO BE DONE,” designers must insure that complete and detailed information is provided. This is necessary so that the construction contractor fully understands what is expected and the Department and contractor do not have a dispute over the work expectations. If the work description becomes too lengthy, it may be necessary to prepare a Special Provision that is incorporated into the Plans.

The road designer should note that all quantities summarized on these specific sheets are transferred directly to the project proposal. Schedules of prices are not incorporated in the Summary of Estimated Quantities.

The only exception to this procedure is if a project contains fence work and there are no demolition or moving items in the Plans. The fence quantities are then incorporated into the Summary of Estimated Quantities Sheet and onto the General Construction Notes Sheet under "Inclusions."

34.2.4 Typical Section Sheets and Miscellaneous Details (Sheets 3, 3A, etc.)

All Construction Plans must contain Typical Sections that fully describe the intended work to be performed on a project. They are normally developed as full Typical Sections. It is recommended that a single Typical Section Sheet contain no more than two mainline sections. Side roads and incidental sections are shown on separate sheets. However, more than two side roads or incidental typical sections may be shown on a single sheet.

34.2.4.1 Scale

For clarification of each Typical Section, provide a horizontal scale that uses one-half to two-thirds of the available sheet width. If a section tends to lose vertical definition, the vertical scale should be exaggerated for clarification purposes.

34.2.4.2 Dimensions

Most Typical Sections have an element that predominates throughout (e.g., 12-foot lane width). However, if there are conditions where this width may vary, place a note indicating the variable width after the standard dimension (e.g., shown 12 ft (varies 12 ft to 24 ft)). Show all dimensions for travel lanes, curb and gutter, earth and paved shoulders, foreslopes, standard ditch bottoms, base and paving materials, etc. Identify construction centerlines and finish grade points on each section. Show all dimensions in feet and decimals of a foot (e.g., 12.5 feet versus 12½ feet).

34.2.4.3 Identification of Materials and Application Rates

Clearly identify all materials and their depth, which comprise the pavement structure, on each Typical Section.

When identifying the pavement structure on the Typical Section Sheet, include the specified type of mix that is noted in the pavement design. This information needs to be

included on the Typical Section Sheet before submitting it to the Pavement Design Engineer for approval.

If the mix is changed during the development of a project, insure that the Typical Section Sheets are also revised to reflect the change. All revised Typical Section Sheets that originally needed the Pavement Design Engineer's approval must be resubmitted to the Pavement Design Engineer.

34.2.4.4 Station Limits

Typical Sections are developed for the entire project. This is generally accomplished by delineating all station limits, to which the section applies, below each Typical Section. Transition areas (e.g., transitioning from a four-lane divided section to a five-lane section) are indicated under the appropriate Typical Section by station limits followed by brief descriptions of the variable dimensions. These station limits should be verified prior to Final Construction Plans completion.

34.2.4.5 Clarification Notes

The designer is advised to make full use of the additional notes on the Typical Section Sheets to help clarify the intent of each section as it relates to the planned improvements.

34.2.4.6 Partial Sections and Blow-ups

The use of both partial sections and area blow-ups are encouraged to help clarify the design features of the improvements. They may be shown on the Typical Section Sheet to which they apply, or grouped together on an additional Incidental Section Sheet.

34.2.4.7 Curb (Disabled) Ramps

On all projects having curb and gutter with sidewalks, the identification of each curb ramp on the individual plan sheets is not necessary. However, include a note on each Typical Section Sheet indicating that curb ramps are to be constructed in accordance with the *SCDOT Standard Drawings*.

34.2.4.8 Design Speed and Exceptions

The design speeds and exceptions are shown on the first Typical Section Sheet for all projects except "C" projects.

On Federal-aid projects, include the minimum design speed criteria and any approved design exceptions in the box located in the lower right corner of the appropriate mainline Typical Section Sheets only.

34.2.4.9 “C” Project Road Group Designation

When plans are being prepared for either Secondary or State “C” projects, add a note to the Typical Section Sheet designating the appropriate road group, see [Section 22.1.2](#). The Project Manager is responsible for indicating the road group designation on the Design Field Review’s Title Sheet. If it is not provided on the Title Sheet, the Design Group Coordinator should determine which road group is applicable and then verify it with the Project Manager. The appropriate CADD cell should be placed directly left of the design speed information block on the bottom right corner of the Typical Section Sheet.

34.2.4.10 Special Details

Special details may be required on Typical Sections for roadway projects where an item of work is not specifically designated in the Department’s *Standard Specifications* or *SCDOT Standard Drawings*. Special details may be in the form of new devices, new technology or new ideas.

34.2.4.11 Superelevation Layouts

The road designer may use a superelevation diagram sketch or a superelevation table to assist in the development of the superelevation for a project; see [Figures 34.2B](#) and [34.2C](#).

The superelevation information (e.g., reference stations, distances, edge of traveled way) should be shown on the typical sections as depicted in [Figure 34.2D](#).

34.2.4.12 Miscellaneous Details (Special Drawings)

A Special Drawing is a drawing that is not typically included on all projects, but is tailored to a particular situation on the project. Examples of Special Drawings that are stored in the CADD files are:

- Special Survey Codes Legend,
- Sound Barrier Wall,
- Retaining Walls,

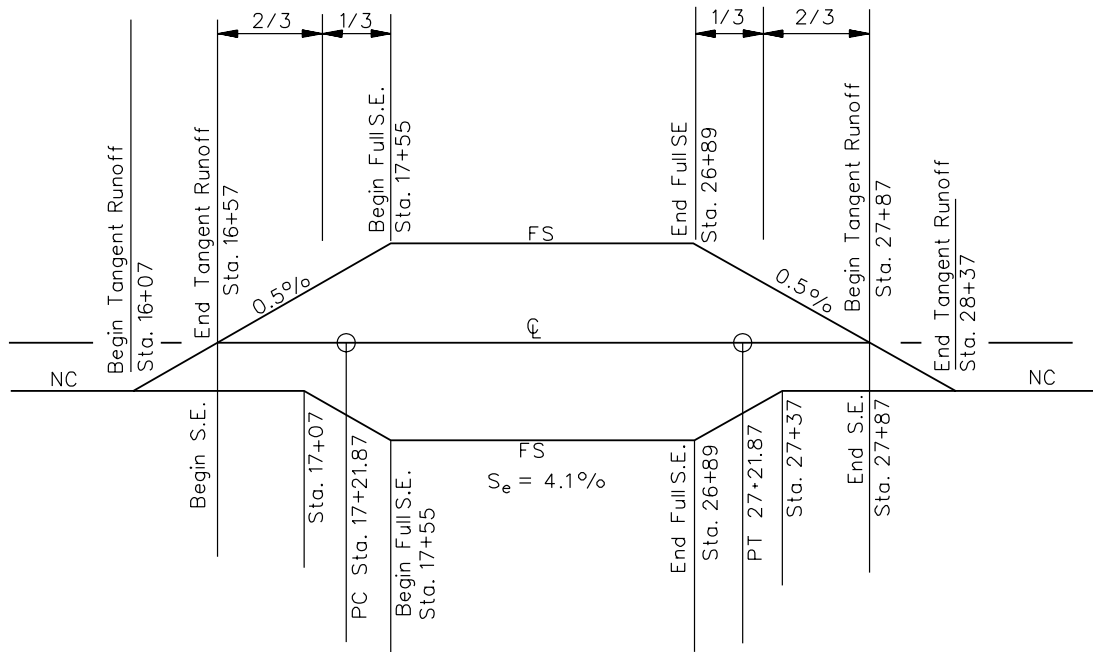

* Note: This is in compliance with SCDOT Standard Drawing 100-6.

SUPERELEVATION DIAGRAM SKETCH (REVOLVING ABOUT CL)

Figure 34.2B

- Box Culverts,
- Large Drainage Boxes,
- Standard for Replacing Pavement on Backfill Over Pipe in Existing Roadways, and
- Guardrail Application At Bridge With Sidewalk.

Special Drawings should include the bid items necessary for construction, where applicable, on the drawing.

34.2.5 Right of Way Data Sheets, Property Strip Map, Traffic Data Sheets (Sheets 4, 4A, etc.)

All projects requiring the inclusion of special sheets to document and summarize the right of way elements are to be incorporated into the Sheet No. 4 series of the Plans.

CURVE NO. 2 PI STA. 22+24.75							
SPEED = 60 MPH				NC = 2.08%			
(1) SUPERELEVATION RUNOFF = 100 FT				LC = 1,000 FT			
$e_{(max)} = 8\%$				R = 3800 FT			
				$S_e = 4.1\%$			
				(2) TANGENT RUNOUT = 50 FT			
(1) See Chapter 11.							
(2) See Section 11.3.							
(3) Values expressed in elevation (feet) referenced to design datum.							
STATION	12 FT LT. ⁽³⁾ of \mathcal{C}	FINISH GRADE	12 FT RT. ⁽³⁾ of \mathcal{C}	ADDITIONAL PAVEMENT WIDTH LT. IN FEET	LT ⁽³⁾ EDGE	ADDITIONAL PAVEMENT WIDTH RT. IN FEET	RT. ⁽³⁾ EDGE
Begin Tangent Runoff 16 + 07.00	350.25	350.50	350.25				
End Tangent Runoff Begin S_e 16 + 57.00	351.00	351.00	350.75				
RC 17 + 07.00	351.75	351.50	351.25				
PC 17 + 21.87	352.08	351.72	351.36				
Max S_e 17 + 55.00	352.49	352.00	351.51				
18 + 00.00	352.99	352.50	352.01				
18 + 50.00	353.49	353.00	352.51				
↓	↓	↓	↓				
26 + 50.00	361.49	361.00	360.51				
Max S_e 26 + 89.00	361.89	361.40	360.91				
27 + 00.00	361.95	361.50	361.05				
PT 27 + 21.87	362.06	361.72	361.38				
RC 27 + 37.00	362.15	361.90	361.65				
27 + 50.00	362.20	362.00	362.25				
End S_e 27 + 87.00 Begin Tangent Runoff	362.40	362.40	362.15				
28 + 00.00	362.30	362.50	362.25				
End Tangent Runoff 28 + 37.00	362.65	362.90	362.65				

Note: Sample for portion of curve only.

SUPERELEVATION TABLE

Figure 34.2C

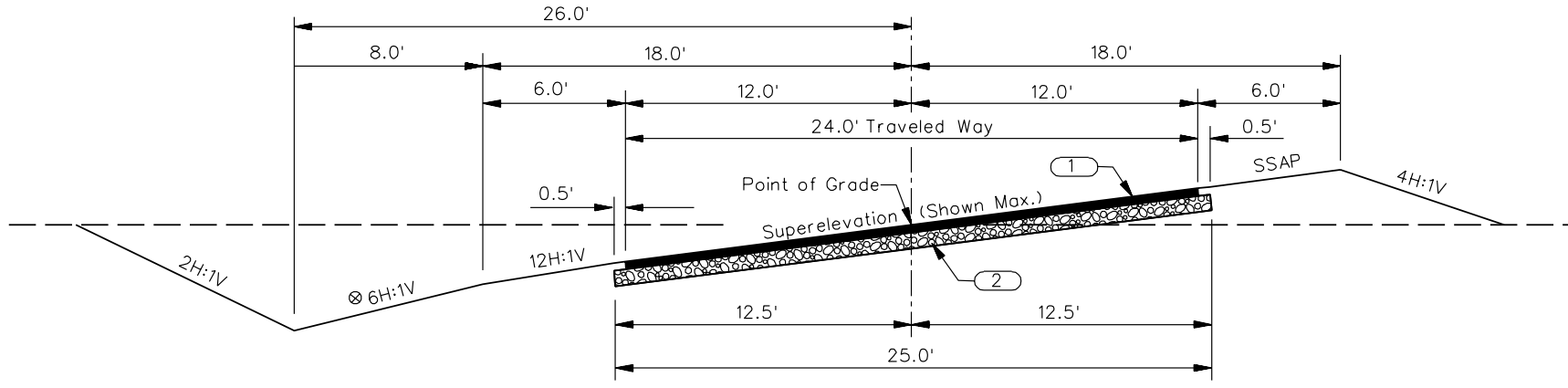

Use This Section STA. 10+00 to STA. 25+00 on RD. S-123

⊗ Note:
 This slope may be varied when a deeper ditch is necessary for drainage purposes, using a minimum slope of 12H:1V and a maximum slope of 4H:1V. Where a deeper ditch than provided by a 4H:1V is necessary, the ditch shall be placed farther from the \mathcal{C} continuing the 4H:1V slope to provide for the necessary depth.

Pavement Legend

1	Hot Mix Asphalt Concrete Surface Course Type 1 (150 LBS/SY)
2	Graded Aggregate Base Course (8" Uniform)

**TYPICAL SECTION
 (Superelevation Section)**

Figure 34.2D

34.2.5.1 Right of Way Data Sheet

The Right of Way Data Sheet is used to summarize all agreed upon transactions between property owners and the Department. It contains standard headings that, when properly completed, will provide a complete status of affected properties.

The designer should make full use of the comments column to the extent the Right of Way Data Sheet depicts all work anticipated or provides additional data beneficial to the property owner and the right of way agent.

It is necessary that all acreage be identified by highlands and marshlands on the Right of Way Data Sheet, where applicable.

Sufficient space is available on the Right of Way Data Sheet to include clarification notes or special symbols.

Items to be shown on the Right Of Way Data Sheet include:

- tract number;
- name, as it appears on instrument of record;
- tax map reference;
- total area in acres or square feet as referenced on the instrument of record;
- obtained area in acres or square feet;
- remainder of area in acres or square feet if less than 0.25 acre;
- date of acquisition provided by the Right of Way Office;
- type of instrument provided by the Right of Way Office; and
- construction permission.

Items to be shown on Right of Way Plan Sheets include:

- tract number; and
- dates and action taken by the Right of Way Office (completed by Right of Way personnel).

For detailed information on right of way, see [Chapter 30](#).

34.2.5.2 Property Strip Map

When property boundaries are required for closures, the required information should be shown on the Plan and Profile Sheets, if practical. If this alternative is not practical, the designer may elect to show property closures by inserts that are drawn on separate sheets and are incorporated into the Plans. A third alternative is to develop a Property Strip Map for inclusion in the Plans.

If individual property closures are shown on separate sheets, incorporate them into the Sheet No. 4 series of the Plans.

Items to be shown on the Property Strip Map include:

- tract number;
- all present and new right of way and property lines labeled;
- existing man-made and natural features (e.g., roads, streams, lakes, cities, towns, landmarks);
- property inserts may be included;
- assigned parcel numbers and total acreage; and
- any breaks in the Control Access or Limited Access Line.

34.2.5.3 Property Revisions

Any plan revisions made after Right of Way Plans are submitted must be detailed by placing a revision note on the appropriate plan sheet. If the revision affects a particular tract, this should be noted. All plan revisions, regardless of their impact on the right of way, are to be routed to the Right of Way Office in the normal manner to insure that the right of way agent has the correct information to provide to the affected landowners.

34.2.6 General Construction Sheets (Sheets 5, 5A, etc)

The *Road Design Plan Preparation Guide* presents the typical general construction notes that are commonly used on roadway projects. The designer must insure they are applicable and accurate for the present project.

34.2.6.1 Plan Sheet Layout

The designer may determine that the project would benefit by the addition of a Plan Sheet Layout Index. This can be accomplished by referencing each plan sheet on the Title Sheet location map, if it is to the appropriate scale. A separate Plan Index Sheet may also be developed for this purpose.

34.2.6.2 General Construction Notes

Several general construction notes are typically placed on all roadway projects. See the *Road Design Plan Preparation Guide* for a list of the typical notes.

34.2.6.3 Reference Data Sheets

Examples of information shown on Reference Data Sheets include:

- reference points for PC, PI, PT and POTs,
- control points,
- benchmark locations and elevations,
- horizontal curve data, and
- vertical curve data for curbs and/or sidewalks,

34.2.6.4 Utility Data Sheet

Where several utilities are indicated on the Plans, it may be desirable to provide a separate Utility Data Sheet. The Utility Data Sheet should provide information on the following:

- type of utility (e.g., telephone, gas, water);
- location of utility, by station and offset from the centerline;
- owner of the utility;
- address of the utility owner;
- contact telephone number of the utility; and
- contact person, if possible.

34.2.6.5 Drainage Data Sheet

Where the Plan and Profile Sheets are complex, it may be desirable to provide a separate drainage sheet to improve the Plan Sheet's clarity. Number the drainage structure on the Plan Sheets and then describe the drainage structure on the Drainage Data Sheet. This may include the:

- pipe size,
- length,
- end type,
- material type,
- end elevations, and
- other special details.

34.2.7 Plan and Profile Sheets (Sheets 6, 7, 8, etc.)

The Plan and Profile Sheets are the key elements of a project and must provide project clarity, correctness, orderliness and completeness. A proper drawing scale commensurate with the project's complexity and topography is necessary.

34.2.7.1 Topographic Features

Each Plan and Profile Sheet should contain complete and accurate topographic information. The information is obtained from surveys, field reviews and the Design Field Review process. Topographic information should be concise and to the point so that the existing conditions are well represented and understandable (e.g., when making reference to a residence, the Plans should indicate one story frame residence). The designer should insure that items (e.g., churches, schools, businesses, service stations with underground tanks, playgrounds, parks, historic monuments, hospitals) are properly identified on the Plans. Clearly identify environmentally sensitive areas, in which construction and construction staging activities are to be avoided, using stations and offsets. Identify all highways, streets, drives and parking areas. Include the highway and/or street and route designation. Indicate the existing pavement type for each. Clearly show the existing property and right of way documentation on the plans. For projects where the topographic information is over 5 years old, a decision should be made between the Program Manager, Road Design Section and the Surveys Office on whether to secure current data.

34.2.7.2 Right of Way and Property Features

For guidance on right of way and property features, see [Section 34.2.5](#).

34.2.7.3 Existing Utilities

Show above ground utility topography within and adjacent to the highway corridor, on the Plans. Substantial utility data is available from mapping and field surveys. Additional data that may be required can be obtained from the Utility Office including data relative to planned utility improvements and relocations. Show the names of the various utilities on the first Plan and Profile Sheet and the Utility Data Sheet.

Where Subsurface Utility Engineering (SUE) is used, the SUE firm will be responsible for providing the utility information.

For additional information on utilities, see [Section 26.2.1](#).

34.2.7.4 Horizontal and Vertical Alignments

The geometric design is defined by station and offset, median locations, ramp nose locations and pavement transition lengths. It also includes stations, angles, offsets and ties to the roadway centerline for relocations of adjacent roads, retaining walls, relocated stream channels and relocated railroads.

34.2.7.4.1 Coordinate System

It is recommended that all major roadway projects be tied into the State Plane Coordinate System. Delineate the following in the Plans, showing the northerly and easterly coordinate values of the State Plane Coordinate System:

- all existing monumentation,
- all new monuments, and
- all new points of intersection (PI's).

Include northerly and easterly coordinates on all proposed curve PI's and random intermediate points on tangent (POT) not to exceed 3,000 feet in distance between points.

Minor road projects may be developed with or without a coordinate grid system. If using a coordinate system in the design, the system may be random. Set or establish at least two monuments in the field for control.

34.2.7.4.2 Horizontal Alignment

All distances are calculated and expressed to the hundredth of a foot. All points of curvature (e.g., PC, PT, PRC, PCC) are shown on the centerline or baseline of the horizontal alignment. Tangent centerlines should show the alignment bearings expressed by quadrant degrees, minutes and seconds (in the direction of stationing). Station registration is indicated via a tick mark on the centerlines. Stationing is labeled at a minimum of every 500 feet for 50 scale drawings and every 100 feet (i.e., every station) for 20 scale drawings. For the method of station presentation, see the *SCDOT Standard Drawings*.

[Figure 34.2E](#) provides an example of horizontal geometrics.

Centerline reference points should be shown on the Reference Data Sheet, and the designer should clearly indicate which reference points apply to the appropriate roadway centerlines.

Where it is necessary to relocate the roadway centerline of a project, new points for the relocated PC, PI, PT, and POT's are determined and shown on the Reference Data Sheet. Identify these new points as relocated points. Each point is identified by xyz coordinates on the Reference Sheet and shown on the Plan Sheet as "RELOCATED PC," with stationing. This procedure is in lieu of providing station offsets for the relocated points. Use the new coordinate description on all future work. Place a note on the Plan Sheet to bring attention to the relocation:

NOTE: RELOCATE CENTERLINE BETWEEN STA. A AND STA. B.

A set of Plans with only one or two plan sheets typically will not have a Reference Data Sheet due to the simple nature of the Plan Sheets themselves. It is then necessary to show the relocation notes and references on the Plan Sheets.

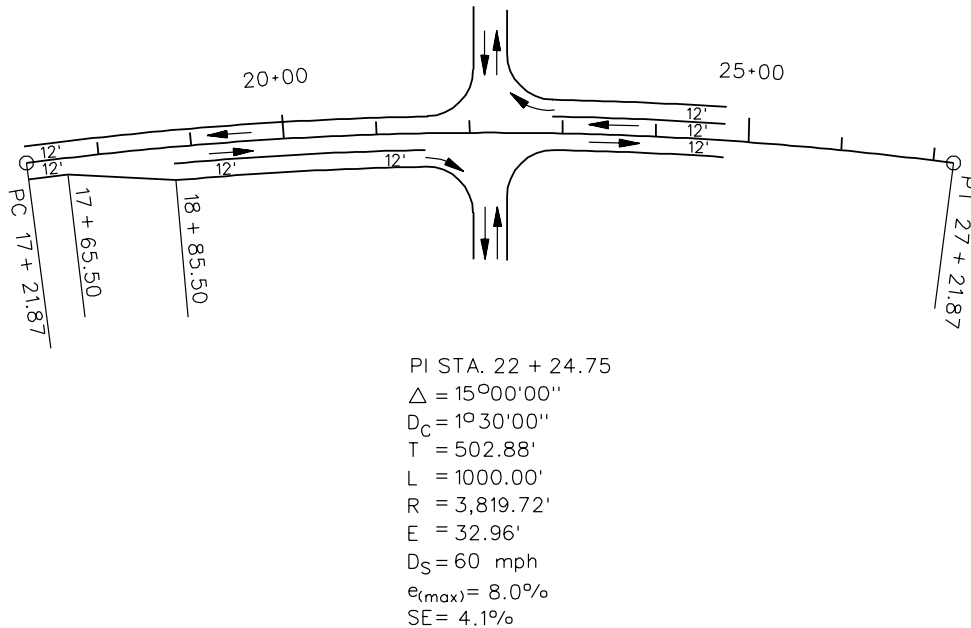

HORIZONTAL GEOMETRICS

Figure 34.2E

34.2.7.4.3 Vertical Alignment

Show the following on the Profile:

1. Tangent Sections. All straight line slopes (grades) on the vertical alignment are expressed as a positive or negative percentage (i.e., feet rise or fall per 100 feet of horizontal distance).
2. Vertical Curves. Include the following vertical curve data on the profile:
 - the length of curve expressed in feet,
 - the curve beginning (PVC) expressed by stationing with PVC elevation,
 - the curve ending (PVT) expressed by stationing with PVT elevation, and
 - the intersection (PVI) of forward and back tangent grade lines expressed by stationing with PVI elevation.
3. Elevations. Show profile grade elevations to two decimal places for points on the profile at all PVC's and PVT's and at 50-foot intervals throughout vertical curves.

In urban areas, it may be necessary to show profile elevations at more frequent intervals. Also show finished profile grades at all intersection points and at all tie points used in conjunction with cross slope elevations to establish the beginning of ramps, loops or flyover profile elevations.

4. K-Values. Show the design K-value for the vertical curve on the Profile.

34.2.7.5 Travel Lane Lines

In most cases, the Preliminary Design Group provides the edge of traveled way (ETW) line, including those with curb and gutter. This should enhance the automation of creating the templates for the project. For the plan sheet, the ETW line should be paralleled with a face of curb (FOC) line available in the custom line style palette called FOC. Back of the curb line will not be shown in any case. Where there is a grass buffer strip, the front edge of the sidewalk is shown. In all cases, the back of the sidewalk is shown.

For additional information, see the *Road Design Plan Preparation Guide* and the *Road Design CADD Users Guide*.

34.2.7.6 Proposed Roadway Features

Dimension all the proposed roadway features and relay to the users the exact intent of the proposed roadway improvements. This includes edges of traveled way, curb lines, curb and gutter lines, turning radii, tapers, nosings, medians (flush or raised), paved shoulders (greater than 4 feet in width), median barriers, bridges, sidewalks, etc. Show all widths, offsets and stationing, where appropriate.

34.2.7.7 Construction Limits

Indicate construction limits on the Plans via a dashed line. The distance from the centerline or baseline and the cut/fill notation is registered on the drawings at each location where a cross section has been developed.

34.2.7.8 National Pollutant Discharge Elimination System (NPDES) Lines

Determining the width of the permanent right of way is primarily a function of the typical section and drainage requirements for a section of roadway. Although these are the prevailing criterion to set right of way, additional criteria includes the requirements of the NPDES.

The purpose for the NPDES line is to show the contractor where it is necessary to clear and grub outside of the construction limits line, especially when the clearing and grubbing pay item is within roadway. When the clearing and grubbing is within the right of way, then the NPDES line is only necessary when it extends outside of the right of way line.

See the *Requirements for Hydraulic Design Studies and Road Design Plan Preparation Guide* for more detailed information on NPDES lines.

34.2.7.9 Drainage Improvements

Most highway projects require new drainage facilities and/or the improvement of existing drainage. This may be in the form of ditches, channels, streams, culverts and/or closed drainage systems.

It is the designer's responsibility to correctly document all planned improvements. For open drainage conditions, it is generally sufficient to show the required information next to the proposed feature. Label all storm drainage information (e.g., direction of flow, length, size, type (if different from typical), slope of pipes) on the Plans. Indicate the location by station of drainage appurtenances together with type of structure and flow invert elevations (in/out). Culvert identifications include type, size, length, skew angles and elevation inverts (in/out). Ditch and channel improvements may require side slope and bottom width dimensions.

Stream, creek and river crossings should include the following information:

- flows in cubic feet per second (CFS) for various storm frequencies;
- low, high and ordinary water elevations;
- navigational clearances;
- headwater drainage areas in acres or square miles; and
- other pertinent information.

The designer should check with the Hydraulic Engineering Section for the exact information required.

34.2.7.10 Existing Ground (Pavement) Line

Once the final alignment is determined, the designer should show the vertical location of the existing ground or pavement on the profile. Show the ground line at the profile grade point as depicted on the typical section, unless otherwise noted. The existing vertical alignment is noted as existing ground or pavement line. The ground line should show all elevation breaks to the degree known and, more specifically, the low points to

include stream, creek and river bottoms. Also, delineate the top and bottom elevations of the banks of streams, creeks and rivers.

34.2.7.11 Earthwork Balance

Include the balance of earthwork on the Profile Sheets for all projects. Show the balance points to the nearest tenth of a foot. Typically, the limits of haul for each balance should not exceed 3,000 feet (the freehaul limit). It should be noted where over 3,000 feet overhaul exists, overhaul should be computed.

For detailed information on balancing earthwork, see [Section 35.2](#).

34.2.7.12 Environmental Considerations

The designer must insure that all commitments made in an approved environmental document are included in the Final Construction Plans (e.g., noise walls, detention ponds, wetlands protection).

Environmentally sensitive areas may be identified on the Plan and Profile Sheet. The Right of Way Data Sheet is used to identify those properties where hazardous waste or UST's are located. This insures that they are properly considered during the right of way appraisal and negotiation process.

34.2.7.13 Traffic Information

Future traffic data (e.g., turning volumes) for all major intersections is shown on the Intersection Detail Sheet, if available, or the Plan and Profile Sheet.

34.2.7.14 Railroad Topography

All existing railroad information is plotted in detail showing mile posts (or distance to nearest mile post), right of way, tracks (labeled mainline, owner, DOT crossing number) and existing drainage. Proposed new drainage facilities also are shown. For detailed information on railroads, see [Chapter 6](#) and [Section 15.8](#).

34.2.7.15 Profile Sheets (Sheets 6A, 7A, etc.)

Where the project is complex (e.g., urban projects, interchanges), it is often desirable to provide separate sheets for the plan details and profiles to adequately show the details. Also, separate Profile Sheets may be required for side roads and other approaches if significant construction is taking place on these facilities.

34.2.7.16 Drainage and Utility Plan Sheets (Sheets D1, D2, etc.)

Where the project is complex, the designer may elect to provide separate Plan Sheets for the drainage and/or utility layouts. This will allow the contractor to adequately determine the details for these features. These are typically reproducible copies of the Plan Sheets or may be individually produced sheets at a scale commensurate with the extent of detail required.

34.2.7.17 Miscellaneous Items

The designer should insure that all Plan and Profile Sheets contain the following information:

- drawing scales;
- north arrows, generally placed near the upper right hand corner of the sheet;
- survey and construction center lines;
- bearings;
- station equation;
- revision blocks; and
- properly completed sheet title boxes.

34.2.8 Details of Plan Sheets (Sheets 12, 13, etc.)

Support drawings in the form of plan sheets for blow-ups, top of curb elevations, centerline staking plans, etc., are to be incorporated in the Plans, as necessary. These sheets should be numbered consecutively beginning with a number one higher than the last Plan and Profile Sheet.

34.2.8.1 Top of Curb Profiles

For all projects proposing curb or curb and gutter, profiles are developed along the top of the curb for all locations. They are delineated as curb grades on separate Curb Grade Sheets and computed in the same manner as discussed for vertical alignments in [Section 34.2.7.4.3](#). Where sidewalks intersect the mainline, the profile plot should be extended across the intersection along the mainline edge of traveled way and shown as a dashed line. In instances where side roads intersect the mainline and do not have curb and gutter, it is not necessary to plot profiles along radii curbs unless there are indications of drainage problems.

34.2.8.2 Interchange Layout Sheets

For interchange improvements, it is necessary to supplement the standard plan data with additional information that clarifies the intent of the design and clearly depicts the relationship of all elements of the interchange. This is best achieved through the addition of reduced scale (no smaller than 1 inch = 200 feet) geometric layout drawings and reduced scale grading and drainage drawings adjusted to the scale necessary to depict the interchange layout on a standard size sheet. Consider providing the following sheets:

1. Interchange Geometric Layout. This drawing depicts the overall geometrics of an interchange and how each element of the improvement relates to the mainline and crossroad(s).
2. Miscellaneous Profiles. As a result of developing full-size plan drawings in interchange areas, it is sometimes necessary to develop separate Profile Sheets for ramps and connector roads, see [Section 34.2.7.15](#). If the interchange plan shows the full extent of work for crossroads, side streets, frontage roads, etc., their respective profiles may be shown on separate sheets.

Where structure separations are proposed, show them graphically at their proper location on the profile.

3. Grading and Drainage Plan. Conventional drawings (e.g., Plan and Profile Sheets, Cross Section) and other detail sheets cannot always include the full intent of the proposed work. For this reason, it may be beneficial to incorporate a Grading and Drainage Supplemental Plan Sheet, see [Section 34.2.7.16](#). This drawing should clearly indicate the overall intent and extent of work and should prevent the designer from overlooking potential problem areas not readily delineated by the cross sections.

Proposed grading work is delineated by a maximum 5-foot solid contour line for all internal areas of the interchange quadrants. External areas do not need to be contoured. Generally, these areas are sufficiently delineated by the cross sections. The existing contours are shown on the Layout Sheet only to the extent that they tie into the proposed contour system.

If not included on the other drawings, all proposed drainage is shown in full detail.

Cross section match lines from one roadway element to another are shown.

34.2.8.3 Staking Plan Sheet

For complex projects, designers may develop a Staking Plan Sheet. This drawing shows the minimum data (e.g., centerline layout, major traverse control points, coordinate values of critical points and monument descriptions). If desired, this drawing may be expanded to show all centerlines, curve data, coordinated points and survey baselines. This drawing is developed to clarify the plans and can be used by field construction personnel as an easy reference to check the horizontal geometry; see [Section 34.2.7.4](#).

34.2.9 Sequence of Construction and Traffic Control Plan (Sheets TC1, TC2, etc.)

On non-complex highway projects, the construction sequence and control of traffic is easily discernable and any needed clarification is shown by use of plan notes. As projects become more complex, the need arises for additional clarification through the development and inclusion of both the construction sequence and control of traffic sketches and notes.

34.2.9.1 Work Zone Traffic Control Sheets

The Traffic Engineering Division has developed a set of typical sheets and construction notes that may be used on roadway projects that are specific to the control of traffic during construction. The designer is cautioned to carefully review these sheets for applicability, completeness and clarity as they pertain to each specific project.

34.2.9.2 Work Zone Traffic Control

Traffic control drawings should be incorporated into a schematic layout of the improvement and include intersecting roads and streets for the purpose of depicting the location and type of permanent construction signs to use during construction. Permanent construction signs must be quantified and included in the Summary of Estimated Quantities Sheet.

The construction sequencing and temporary traffic control should not be left until the later stages of plan completion, but should be considered in preliminary planning and continually refined through the entire plan development process.

On complex projects, (e.g., urban settings that involve existing roads and streets) the construction work accomplished for each phase of project development is clearly identified on the Plans. The designer may develop multiple reproductions of the project Plan and Profile Sheets to achieve this goal. Using uncluttered drawings that depict only the existing conditions and delineating the new work thereon for each phase until

all work is completed is another method of achieving this goal. The designer should include major work items (e.g., the removal and demolition of pavements, box culverts, bridges) as required in each phase of the work.

Most traffic control items (e.g., signs, cones, barrels) required by the contractor during construction are addressed in the *Standard Specifications* and are accounted for in the Summary of Estimated Quantities Sheet under the pay item "Traffic Control." Temporary concrete barriers, used for the control of traffic during various construction phases and stages, must be quantified separately on the Summary of Estimated Quantities Sheet as a pay item. The Traffic Engineering Division should be consulted for its current practice of payment for work zone traffic control items. Major projects (e.g., the improvement of freeways and arterial highways) may require more elaborate Traffic Control Plans. This needs to be coordinated with the Traffic Engineering Division.

34.2.9.3 Detour Plans

Traffic detours may be implemented through the use of existing roads, construction of additional facilities or a combination of both. If the detour is entirely over existing routes, this route and accompanying detour signs are shown on the Work Zone Traffic Control Sheets.

If existing routes used for detours require pavement overlays and/or widening, they are shown on the mainline Plan and Profile Sheet, a reproduction of the mainline Plan and Profile Sheet or as a separate drawing.

Detours requiring new construction necessitate that the alignment geometry be shown and developed on a separate Plan and Profile Sheet. This sheet can be created from a reproduction of the mainline Plan and Profile Sheet, for all or any portion of the detour that can be shown, or by producing a new sheet and developing the detour geometric design details.

It will be necessary to quantify all pay items required to construct the detour as well as those pay items necessary for its removal and restoration.

34.2.9.4 Work Zone Control Plan and Detours

For complex projects, Design Field Review prints should include a phased plan for maintaining traffic during construction. The sequence identifies where traffic is relocated during various phases of construction that encroach on current roadway locations. This plan is a combination of small-scale drawings identifying areas of construction and showing the location of traffic during the respective construction encroachments. The drawing should be accompanied by a brief narrative description of

construction activity and concurrent traffic operations. A complete narrative will be developed later as a Special Provision and incorporated into the Contract. The Work Zone Traffic Control Plans should describe the types and locations of traffic control devices and signs used at each phase of traffic relocation if different from the normal practices contained in the *Manual of Uniform Traffic Control Devices (MUTCD)*. The plan will identify lane widths, transition taper widths and any geometry necessary to define temporary roadway alignments. The plan should also address the type of surface used for all temporary roadways. If detour plans are included, they should be finalized at this stage.

34.2.10 Electrical and Lighting Plans (Sheets E1, E2, etc.)

Although lighting design may be incorporated into Final Construction Plans, a section addressing lighting specifications is not presently included in the Department's *Standard Specifications*. However, a sample Special Provision for lighting may be obtained from the Traffic Engineering Division. When packaged as part of the Final Construction Plans, all design drawings are prepared in the standard roadway sheet format. A complete lighting design package includes plans, quantities and specifications necessary for bidding purposes. If development of these plans and specifications are required, the Traffic Engineering Division is responsible for preparing these plans. However, the road designer is responsible for incorporating the quantities onto the Summary of Estimated Quantities Sheet.

34.2.11 Landscaping Plans (Sheets L1, L2, etc.)

When landscaping items are incorporated into the Plans, they may be delineated on the standard Plan and Profile Sheets, reproducible copies of the Plan and Profile Sheets, or individually produced sheets at a scale commensurate with the extent of detail required.

The location and limit of all single species of trees, plants, shrubs, etc., and plant groups and beds are clearly indicated on the Plans. The plans include all special details necessary for placing, supporting, mulching, fertilizing, trimming, etc. of the plants.

Landscaping quantities should be sub-summarized for grouping of like quantities so that they can easily be included in the Summary of Estimated Quantities Sheet.

34.2.12 Pavement Marking Plans (Sheets PM1, PM2, etc.)

Pavement Marking Plans are developed in accordance with the *Manual on Uniform Traffic Control Devices* and the *SCDOT Standard Drawings* for pavement markings and raised markers. The Pavement Marking Plans should include the improvement layout plan at a pre-selected scale, preferably not exceeding a 100 scale, and a copy of the

appropriate *SCDOT Standard Drawings*. The layout sheets should show all lane lines, edge lines, centerlines, markings for passing and no passing situations (the limits of which will be determined in the field by the Resident Construction Engineer), stop lines, channelizing lines, pavement arrows and pavement markers. Notes that can help clarify the Plans are encouraged. The Traffic Engineering Division is responsible for the development of the pavement marking design and associated quantities. Line item quantities for both permanent and temporary pavement markings are incorporated into the Summary of Estimated Quantities Sheet by the road designer.

34.2.13 Signing Plans (Sheets SN1, SN2, etc.)

Although signing design may be incorporated into the Final Construction Plans, a section addressing signing specifications is not presently included in the *Standard Specifications*. However, a sample Special Provision for signing may be obtained from the Traffic Engineering Division. When packaged as part of the Final Construction Plans, the designer should insure that all designs and drawings are prepared on the standard roadway sheet format. A completed signing design includes plans and quantities for bidding and specifications. If development of these plans and specifications are required, the Traffic Engineering Division is responsible for preparing these plans. However, quantities from these sheets are included on the Summary of Estimated Quantities Sheet by the road designer.

34.2.14 Traffic Signal Plans (Sheets TS1, TS2, etc.)

When incorporated in the Plans, traffic signals are developed in accordance with the *Manual on Uniform Traffic Control Devices* and all details of the design are presented on the standard roadway plan sheet. The Traffic Engineering Division is responsible for the development of the Traffic Signal Plans and all associated quantities. The road designer is responsible for incorporating traffic signal quantities in the Summary of Estimated Quantities Sheet.

34.2.15 Roadway Structure Plans (Sheets S1, S2, etc.)

Roadway structures consist of non-bridge type structures (e.g., retaining walls, footings and foundations, box culverts, pedestrian overpasses, buildings for weigh stations, rest areas). These items may appear in the Plans with or without bridge improvements and are typically included with the Final Construction Plans.

Normally, the Roadway Structures Design Group will develop these structure plans. However, if these plans are being packaged in the Final Construction Plans, design drawings are prepared on standard roadway sheets with title boxes and all work items

are quantified on the Structure Summary Sheet and included on the Summary of Estimated Quantities Sheet.

34.2.15.1 Drainage Structures

The Right of Way Plans reflect the intent to which drainage impacts the proposed right of way and parcels of land to be acquired. To this extent, the major drainage items are established and documented on the Plans. It is mandatory that the structure type be determined and depicted on the Plans in cases where the roadway overpasses a creek or stream (e.g., bridge vs. box culvert). The same applies for parallel roadway drainage, ditches and channels, conveyance of storm drainage at side roads and driveways and clean out requirements of transverse ditches and streams.

Show the locations of all drainage system structures (e.g., inlets, headwalls, wingwalls, manholes, junction boxes) graphically with the location identified to the station offset and invert elevation. The pipe size and material type are also shown in the Plans by:

- labeling each location on the Plans, or
- developing a drainage tabulation box.

Where drainage structures require inlet, outlet or special treatment, not covered by the *SCDOT Standard Drawings*, prepare a special detail drawing. Show all pertinent dimensions including length, width, thickness, size and location of all concrete and reinforcing steel. Special details should reference the *Standard Specifications* pertaining to the use of materials and construction procedures to be used in the construction of special structures.

Drainage areas are to be shown for pipes 48 inches or greater. Hydrology data should be shown in the details for all culverts 48 inches or greater on Federal-aid projects.

The sectional view is a tool for setting the limits of drainage structures. Inlet and outlet structure locations and invert elevations are established and shown with respect to the roadway shoulder slopes and the existing stream profile. The sectional view should also identify headwater elevation for the appropriate design year storm. Any approach and discharge stream grading or special treatments should be shown in the sectional view along with a transverse section of the channel improvement. For the transverse approach and discharge channels, show the bottom width, side slope, design stormwater elevation, and type and thickness of lining.

Show the hydrology data on the drawings in all cases incorporating bridges/culverts conveying water through a roadway section. Data should be incorporated as recommended in the Hydraulics Engineering Section's publication, *Requirements for Hydraulic Design Studies*.

Sideline pipes are identified as longitudinal pipe culverts in roadway ditches at driveway and other locations. [Section 35.6.3](#) provides the guidelines for establishing pipe lengths for drives.

34.2.15.2 Other Structures

Right of Way Plans should show other structures (e.g., retaining walls) in the plan and cross section views. Include all information that relays the intent of improvements.

Additional right of way should be shown for overhead sign structure footings, if required. Conventional signing should also be checked for additional right of way requirements.

34.2.16 Erosion Control (EC1, EC2, etc.)

The application of temporary erosion control items is generally left to the discretion of the Resident Construction Engineer. However, the designer should carefully review the project and determine if specific applications are required and, if so, they should be shown on the standard Plan and Profile Sheets or reproductions. If necessary, the Plans should show the proposed method of controlling drainage runoff during the various stages of construction so that neighboring streams, bodies of water and properties are not be filled, contaminated or covered by siltation originating from the project construction area. Erosion Control Plans should identify the location and type of measure used to control erosion and sedimentation. The methods may require silt fences, detention ponds, temporary seeding, ditch checks, filtration dams, etc. The Plans should identify the need to maintain, clean and relocate these erosion control measures as the project progresses. Removal of temporary erosion control devices following construction should also be addressed. The Design Field Review will determine the need for a specific erosion control plan.

If additional or specific erosion control items are required, they should be clearly indicated and properly quantified in the inclusion items for erosion control. If reproductions of the Plan and Profile Sheets are used, all Erosion Control Plans should be numbered under the EC series.

The following examples are structures that may provide sediment and erosion control for a project:

- sediment dam and temporary sediment basin,
- multipurpose basins,
- storm drain inlet protection,
- rock ditch checks,
- rock sediment dikes,

- silt fence, and
- pipe slope drains.

Pay items to construct these sediment and erosion control items are described on each drawing. A unique pay item number is available for each.

For additional information on Erosion Control, see [Section 35.5.4](#).

34.2.17 Utility/Utility Relocation Sheets (Sheets U1, U2, etc.)

The Utility Office will provide the Utility/Utility Relocation Sheets for incorporation into the Construction Plans. Any coordination or information needed regarding the relocation of utilities should be accomplished through the Utility Office.

34.2.18 Cross Sections (Sheets X1, X2, etc.)

34.2.18.1 General

The required frequency of cross sections depends, in part, on the type of highway project and the terrain. The purpose of a cross section is to:

- establish reasonable estimated earthwork quantities,
- show foreslopes and back slopes, and
- show non-standard ditches.

Plot the sections progressively in the direction of the increasing stationing beginning at the bottom of each individual Cross Section Sheet.

Final cross sections should reflect existing and proposed roadway templates, slopes as appropriate, superelevation information, earthwork areas and volumes, major drainage items, station equalities, bridge station limits, major drives, intersecting roads, mucking limits and replacement materials and volumes, and other items that clarify the intent of the drawings. See [Figure 34.2F](#) for example cross sections.

34.2.18.2 Existing Ground Lines

Ground lines may be obtained from mapping, field surveys or a combination of both. They should be representative of existing conditions at the exact location of the proposed roadway template. The ground lines should reflect features such as existing road crossings, retaining walls, streams, swales, ridges and buildings.

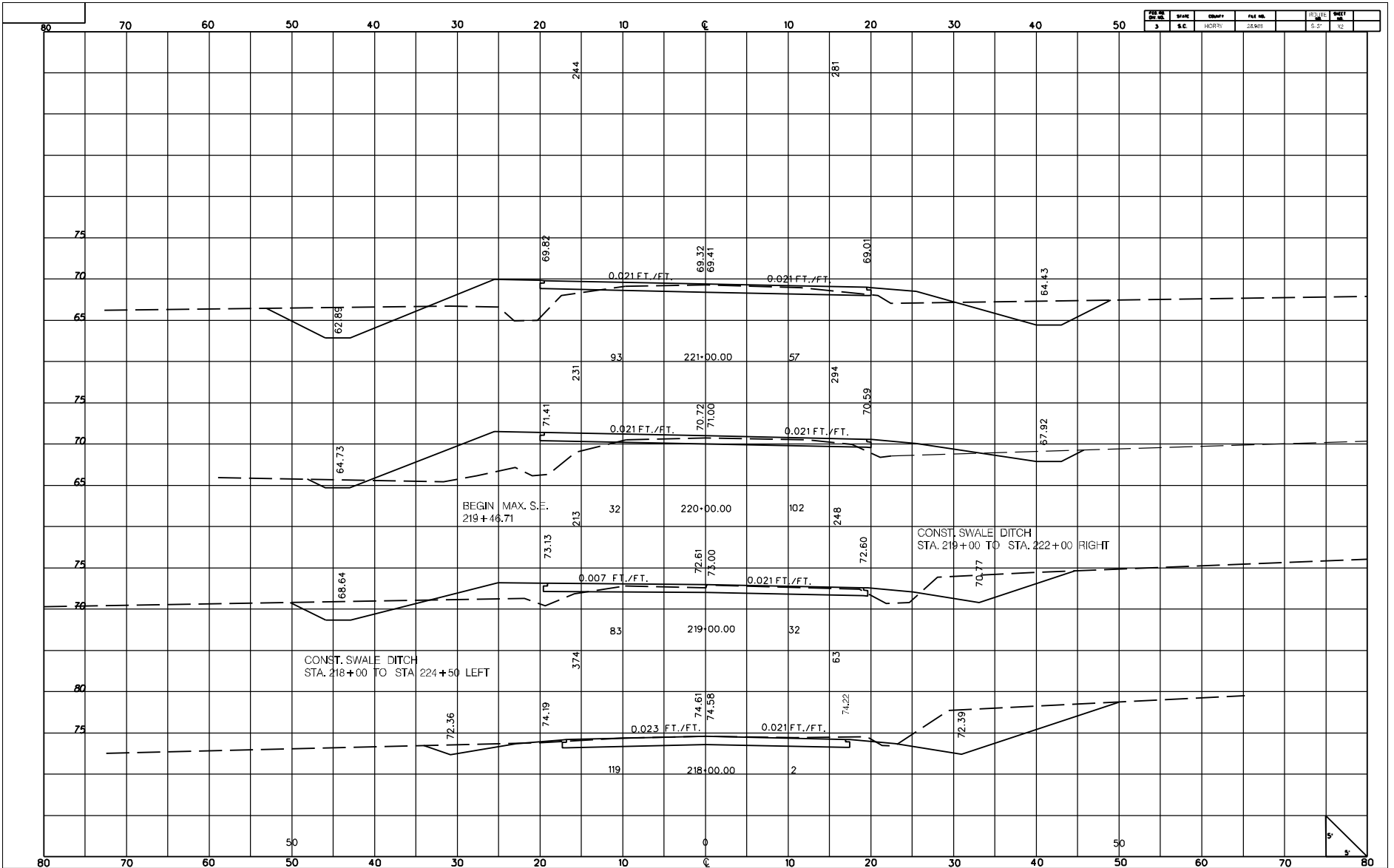

CROSS SECTIONS

Figure 34.2F

34.2.18.3 Proposed Template

The proposed roadway template should reflect the desired roadway cross section at the desired locations. To achieve this, the designer must show pavement breaks, shoulder breaks, foreslopes, backslopes, ditches and identify all slopes beyond the shoulders that are non-typical (that which varies from the typical section) or control slopes. Each cross section is identified by centerline stationing and grade point elevation. It is also necessary to show proposed curbs, sidewalks and retaining walls as these elements help to properly identify the proposed improvements.

34.2.18.4 End Areas and Volumes

End areas are computed mathematically for cuts and fills at each section. Cut areas are registered on the sheet by listing them horizontally to the left of the centerline and below each cross section. Fill areas are registered on the sheet by listing them horizontally to the right of the centerline and below each cross section. Corresponding volumes are listed vertically left and right respectively, above each cross section. Earthwork computations are performed and included as the output data in project file for future reference.

For more detailed information on end areas and volumes for cross sections, see [Section 35.2](#).

34.2.18.5 Clarification Data

Additional data in the form of notes is extremely beneficial during the construction phase of a project. The designer should incorporate the following information:

- bridge limits via begin and end stationing;
- limits of dumped stone, hand placed riprap and mucking;
- location of existing right of way at and beyond the beginning and ending points of a project;
- pavement removal notes and stationing for superelevation; and
- outlet ditch, channel and other drainage information.

34.2.19 Bridge Plans (Sheets BR1, BR2, etc.)

Bridges should be accurately drawn on plan sheets and flagged with a note that shows the length, type (e.g., precast, prestressed, reinforced concrete) and location.

All applicable guardrail notes should be shown; see [Chapter 14](#).

The profile should show the bridge thickness with an elevation shown at both ends of the bridge. Also show toe of fill stations and slopes of fill under the bridge. If riprap is to be placed along the toe of fill, notes should be shown for the riprap. Include the hydrology data and high water mark. In most instances, earthwork should be omitted from toe of fill to toe of fill; however, in certain cases, the designer may need to consider it beyond the toe of fill.

In some cases, it also may be necessary to remove portions of old fill. This should be shown with cross-hatching and estimated as "Unclassified Excavation."

When Bridge Plans are to be incorporated into the Construction Plans, the designer should insure that all drawings are numbered in accordance with the bridge series. The road designer is also responsible for insuring the quantities from the Bridge Summary of Estimated Quantities Sheet are included in the Road Design Summary of Estimated Quantities Sheet.

Table of Contents

<u>Section</u>	<u>Page</u>
35.1 GENERAL	35.1(1)
35.1.1 Quantity Summaries	35.1(1)
35.1.2 Guidelines for Preparing Quantity Summaries	35.1(1)
35.1.3 Coded Pay Items	35.1(2)
35.1.4 Computer Computations	35.1(3)
35.2 EARTHWORK COMPUTATIONS	35.2(1)
35.2.1 Computer Computations	35.2(1)
35.2.2 Manual Computations	35.2(1)
35.2.3 Shrink and Swell Factors	35.2(5)
35.2.4 Determining Earthwork Balance	35.2(5)
35.2.5 Borrow Excavation	35.2(8)
35.2.6 Removal and Disposal of Existing Asphalt Pavement	35.2(8)
35.2.7 Removal and Disposal of Existing Pavement	35.2(8)
35.3 ROADWAY QUANTITIES	35.3(1)
35.3.1 Base Course	35.3(1)
35.3.1.1 Widening	35.3(1)
35.3.1.2 Sand Clay Base Course	35.3(1)
35.3.1.3 Graded Aggregate Base Course	35.3(2)
35.3.1.4 Portland Cement for Base Course	35.3(3)
35.3.1.5 Prime Coat	35.3(4)
35.3.1.6 Hot Mix Asphalt Aggregate Base Course	35.3(5)
35.3.2 Flexible Pavements	35.3(6)
35.3.2.1 Hot Mix Asphalt Binder Course	35.3(6)
35.3.2.2 Liquid Asphalt Binder in Paving Mixture	35.3(7)
35.3.2.3 Full Depth Asphalt Pavement Patching	35.3(8)
35.3.2.4 Asphalt Weight and Thickness	35.3(8)
35.3.2.5 Hot Mix Asphalt Surface Course	35.3(8)
35.3.2.6 Bituminous Surfacing	35.3(9)
35.3.2.7 Rigid Pavements	35.3(10)

Table of Contents

(Continued)

<u>Section</u>	<u>Page</u>
35.5.4.2.5	Rock Ditch Checks..... 35.5(20)
35.5.4.2.6	Storm Drain Inlet Protection 35.5(21)
35.5.4.2.7	Rock Sediment Dikes..... 35.5(23)
35.6	MISCELLANEOUS ITEMS..... 35.6(1)
35.6.1	Guardrail 35.6(1)
35.6.1.1	Guardrail End Treatment 35.6(1)
35.6.1.2	Paving Under Guardrail 35.6(1)
35.6.2	Underground Storage Tanks..... 35.6(1)
35.6.3	Driveways 35.6(1)
35.6.3.1	General 35.6(1)
35.6.3.2	Maintenance of Roadway and Driveways During Construction..... 35.6(2)
35.6.3.3	Pipe Under Driveways 35.6(2)
35.6.4	Aggregate Underdrain 35.6(2)
35.6.5	Fences or Walls 35.6(3)
35.6.6	Shrubs and Plants 35.6(3)
35.6.7	Seeding and Sodding 35.6(3)
35.6.8	Mowing 35.6(3)
35.6.9	Bridges 35.6(3)
35.6.9.1	Concrete Transition Curb and Flume At Bridge Ends 35.6(4)
35.6.9.2	Brick Masonry and Reinforced Brick Masonry Walls 35.6(5)
35.7	REFERENCES..... 35.7(1)

Chapter Thirty-five

QUANTITIES

In addition to preparing clear and concise construction plans, as described in [Chapter 34](#), the designer needs to compile an accurate estimate of the project construction quantities. This information leads directly to the Engineer's Estimate, which combines the computed quantities of work and the estimated unit bid prices. An accurate estimate of quantities is critical to prospective contractors interested in submitting a bid on the project. This Chapter presents detailed information on estimating quantities for highway construction projects.

35.1 GENERAL

35.1.1 Quantity Summaries

Computed roadway quantities, whether manually generated or computer generated, are placed on the Roadway Summary of Estimated Quantities Sheet. However, for complex projects, it may be desirable to develop sub-summary tables for items such as roadway, pavement, earthwork, etc. These may be adaptable to the plan and profile sheets or incorporated on special sub-summary sheets. Typically, a sub-summary table may incorporate such headings as station, offset, location, type, size, thickness and quantities for each selected construction bid item. Totals for sub-summary tables are documented and included in the Roadway Summary of Estimated Quantities Sheet. For more details on the Roadway Summary of Estimated Quantities Sheet, see [Section 34.2.3.1](#).

The reason for these summary details is multi-purposed. It is easy to review and determine that quantities are complete and accurate. It is easy to revise quantities, if changes are made during final reviews or during construction. It also gives assurance that items are constructed in the proper location. It provides an easy method to determine where overruns occur and to develop as-built quantities for final payment.

Every project will require computations for project quantities. If the computations are being prepared manually, develop the quantities on 8.5 x 11-inch computation pads. If the computations are being prepared electronically, then the resultant quantities are shown on the Department's computer printout. Both of these documents must be filed in a project folder for record keeping purposes.

35.1.2 Guidelines for Preparing Quantity Summaries

When preparing quantity summaries, the designer should consider the following guidelines:

1. Specifications. Cross check all items against the *Standard Specifications* and the Supplemental Specifications to insure that the appropriate pay items, methods of measurement and basis of payment are used.
2. Computations. For the preliminary summaries, prepare a separate computation sheet for each item used on the project. Include all computation sheets in the project work file.
3. Rounding. The quantity of any item provided in the summaries should match exactly with the figure provided on the computation sheets. Note any required rounding of raw estimates on the computation sheets. Unless stated otherwise, do not round the calculations until the value is incorporated into the sub-summary tables. For more details on the Department's rounding policy, see [Section 34.2.3.1.2](#).
4. Quantity Splits. Some projects will require quantity splits for work conducted under various financing arrangements. Determine the need to separate project quantities into funding categories during the Design Field Review. For projects requiring quantity splits, organize the sub-summary tables to readily identify each division subtotal and the total of all divisions. Show a subtotal in the sub-summary tables for each county, and each funding source.
5. Engineer's Estimate. Use only the total values from the sub-summary tables to develop the Engineer's Estimate. All items described in the Plans that are to be included in the cost estimate must be shown in the summaries. [Chapter 36](#) provides the Department's criteria for preparing construction cost estimates.

35.1.3 Coded Pay Items

Each pay item has an official title and code number that is tied to the *Standard Specifications*. These items are listed in the SCDOT *Standard Specifications for Highway Construction* and the pay item spreadsheet on the Department's website. The Department uses these coded item numbers for tracking and as a historic database. In most cases, the AASHTO Trns•Port Proposal and Estimates System (PES) will already have the pay item number. See [Section 36.2.2](#) for additional information on computer tracking.

For some specialty or new items, the pay item number may not be in the database. Therefore, if the designer is unable to locate a pay item the designer will be required to conduct the following:

1. Check. The designer should insure that there is not an actual number for the item within the system by entering the item into PES. Do not assume the item is not in the system.

2. Specifications. The designer should review the *Standard Specifications* and Supplemental Specifications to determine if there is a method of payment for the item. If not, see [Section 34.2.3.1.1](#).
3. New Pay Item. If an item does not exist in the PES, the designer may request a new pay item and code number through the Road Design Engineer. It is important for the designer to minimize this option as much as practical. It is preferred that the design be modified slightly in order to use an existing pay item. See [Section 34.2.3.1.1](#) for additional information.

35.1.4 Computer Computations

For most projects, quantity estimates for earthwork and other similar items are computer generated. For small projects, it may be more efficient to manually calculate all quantities, including earthwork.

The designer should review the instruction manuals for GEOPAK to determine how to properly use the software for estimating purposes. GEOPAK can generate most project quantities. Give special consideration to the design on the computer (e.g., cell names, levels, processing procedures) to facilitate the computer generated quantities. Contact the CADD Support Group for assistance with GEOPAK.

35.2 EARTHWORK COMPUTATIONS

35.2.1 Computer Computations

Most highway mainline earthwork computations are determined using the computer. Earthwork quantities for small projects, approaches, side roads, ditches and additional grading features may need to be calculated manually. To calculate the mainline earthwork quantities, the following information is required:

- horizontal and vertical roadway alignments;
- typical sections;
- terrain data;
- shrink and swell factors;
- cut and fill slope rates; and
- identification of sections not to be included (e.g., bridge sections).

End areas are computed mathematically for cuts and fills at each section. Earthwork computations are performed and recorded electronically and the output data should be filed for future reference. Present these amounts on the cross sections as described in [Section 35.2.2](#).

35.2.2 Manual Computations

1. Area Definitions. [Figure 35.2A](#) provides a sample Cross Section Sheet used in calculating cross section end areas. The end areas that are used to compute earthwork quantities are defined by the ground lines and typical section template and are derived planimetrically for cuts and fills at each cross section. End areas are documented in the Earthwork Computation Sheet as shown in [Figure 35.2B](#). Cut areas are registered on The Cross Section Sheet by listing them horizontally to the left of the centerline and below each cross section. Fill areas are registered on the sheet by listing them horizontally to the right of the centerline and below each cross section. Corresponding volumes are listed vertically left and right respectively, above each cross section, which represents the volume between cross sections.
2. Volume Computations. Volume computations are used in calculating earthwork quantities by measuring the area between the existing ground line and subgrade line (i.e., end areas), averaging the area between adjacent cross sections and multiplying by the distance between the cross sections. The volumes are documented on the Earthwork Computation Sheet as shown in [Figure 35.2B](#). Determine volumes for excavation and embankment using the average-end-area formula in [Equation 35.2\(1\)](#).

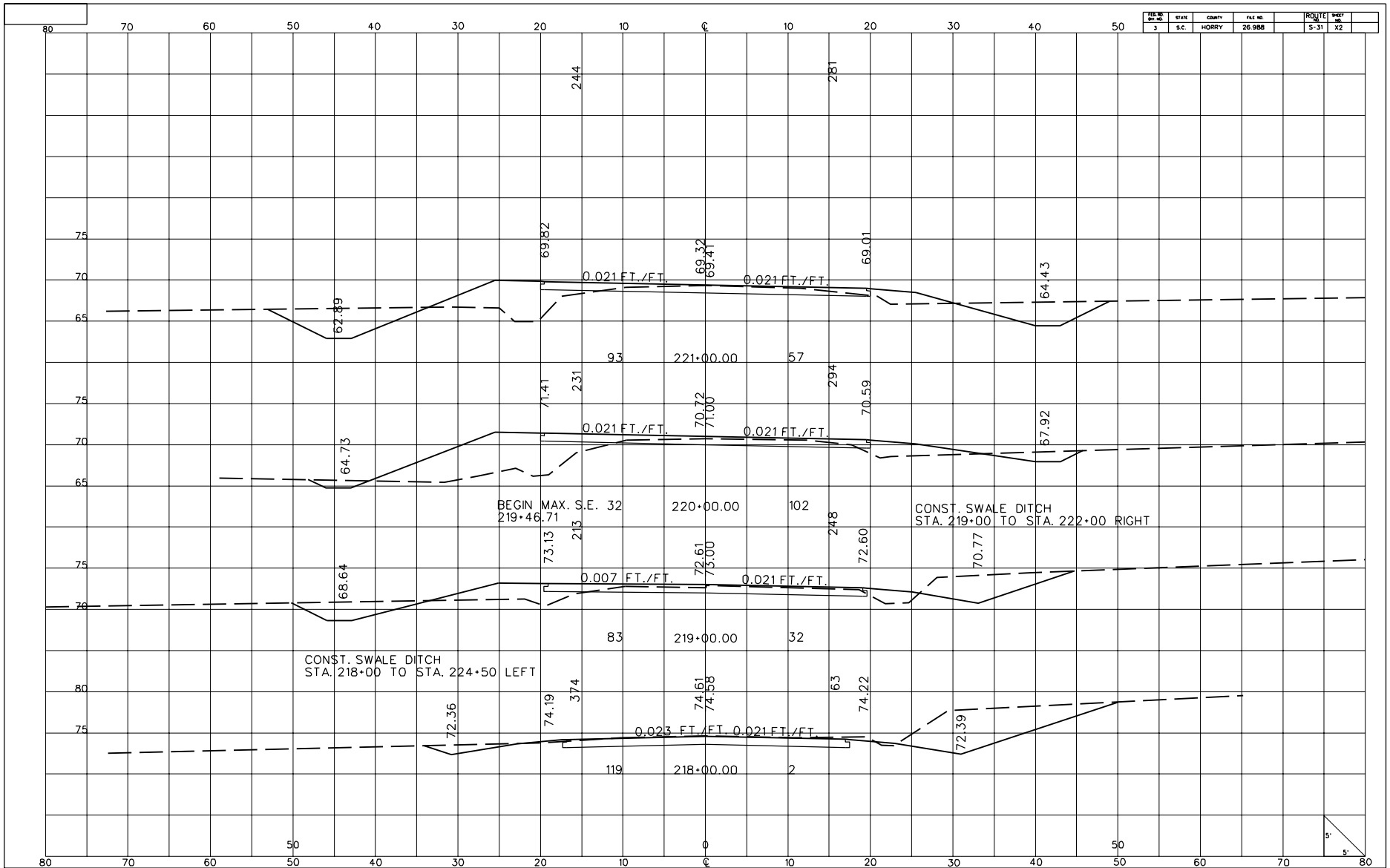

SAMPLE CROSS SECTIONS

Figure 35.2A

EXCAVATION							EMBANKMENT					
STATION	END AREA	DOUBLE END AREA	DISTANCE	VOLUME	BALANCED		END AREA	DOUBLE END AREA	DISTANCE	VOLUME	BALANCED	
					STATION	CUT					FILL	F-30%
0+10 ^{beg}	30				0-10		—					
1+00	209	239	90 ^{beg}	398			—					0 398
+50	45	254	50	235			2	2	25	1		632
2+00	1	46	50	43			36	38	50	35		639
+50	—	1	25	1			58	94	50	87		517
3+00	14	14	25	6			57	115	50	106		385
+50	72	86	50	80			54	111	50	103		331
4+00	—	72	25	33			110	164	50	152	128	167 0
+50	—				4-27	796	139	249	50	231	612	796
5+00	—						110	249	50	231	103	434 134
+50	—						83	193	50	179		667
6+00	9	9	25	4			24	107	50	99		792
7+00	155	164	100	304		516	—	24	50	22		516 0
8+00	228	383	100	709	7-72	824	—				634	824
9+00	206	434	100	804		193	—					193 997
10+00	367	573	100	1061			—					2058
1+00	14	381	100	706			48	48	50	44		2707
2+00	6	20	100	37			277	325	100	602		1961
3+00	20	26	100	48		55	235	512	100	948	640	777 0
4+00	16	36	100	67	13-82	2904	183	418	100	774	2234	2904
15+00	10	26	100	48		12	78	261	100	483	134	162 742
+50	7	17	50	16			34	112	50	104		861
16+00	32	39	50	36			16	50	50	46		885
+50	125	157	50	145			—	16	25	7		749
17+00	131	256	50	237			1	1	25	1		514
+50	133	264	50	244			4	5	50	5		276
18+00	58	191	50	177			15	19	50	18		123 0
18+88 ^{end}	48	106	88 ^{end}	173	18-88	1088	9	24	88	39	837	1088
SHEET TOTAL				5612		5612				4317	4317	5612

EARTHWORK COMPUTATION SHEET

Figure 35.2B

$$V = \left(\frac{A_1 + A_2}{2} \right) \times D \times \frac{1 \text{ CY}}{27 \text{ CF}} \quad (\text{Equation 35.2.1})$$

Where: V = Volume, CY
 $A_1 + A_2$ = sum of cut or fill end areas of adjacent sections, SF
 D = distance between sections, FT

3. **Computation Sheets.** [Figure 35.2B](#) is a sample Earthwork Computation Sheet used in manually calculating earthwork quantities. The columns are used for documenting stations, cross-section areas, volumes between cross sections and balance points. The Earthwork Computation Sheet facilitates the checking process by summarizing the calculation results and provides a record for the project file.

Example 35.2(1)

Given: Cross Sectional Area at Station 10 + 00 = 150 square feet of fill
 Cross Sectional Area at Station 10 + 50 = 110 square feet of fill

Problem: Compute the volume of fill.

Solution:

1. Compute the distance between the two sections.

$$D = \text{Station } 10 + 50 - \text{Station } 10 + 00 = 50 \text{ FT}$$

2. Compute the volume from [Equation 35.2.1](#).

$$\text{Volume} = \left(\frac{150 \text{ SF} + 110 \text{ SF}}{2} \right) \times 50 \text{ FT} \times \frac{1 \text{ CY}}{27 \text{ CF}} = 240.7 \text{ CY}$$

3. Because portions of the equation remain constant and the most frequent intervals for plotting cross sections are 100 feet and 50 feet. The same problem can be expressed as follows:

- a. Sections with 100-foot spacing.

$$V = (A_1 + A_2) \times 1.85185 \quad (\text{Equation 35.2.2})$$

Where: $1.85185 = \frac{100 \text{ FT}}{2} \times \frac{1 \text{ CY}}{27 \text{ CF}}$

- b. Sections with 50-foot spacing.

$$V = (A_1 + A_2) \times 0.92593 \quad (\text{Equation 35.2.3})$$

Where: $0.92593 = \frac{50 \text{ FT}}{2} \times \frac{1 \text{ CY}}{27 \text{ CF}}$

* * * * *

35.2.3 Shrink and Swell Factors

Adjust excavation and/or embankment quantities, calculated either manually or by the computer, by the appropriate shrink and/or swell factor(s). The use of more than one factor for a project may be necessary to describe the characteristics of the excavated material. However, do not apply both shrink and swell factors to the same material. The factors used in the calculations will depend on the soil type, quantity to be moved and engineering judgment. The applicable factors are determined by the Soils Report. The Geotechnical Section prepares the Soils Report. The Department's normal range of shrinkage factors is 30 to 40 percent. The designer should verify the percent shrinkage or swell factor used on the project with the District Construction Engineer when the Design Field Review is conducted for the project.

35.2.4 Determining Earthwork Balance

By using the shrinkage factor determined from past experience (e.g., various types of soil, depths of cuts and fills, type of road to be constructed) an attempt is made to balance the earthwork. This is done in the following manner:

1. If the balance begins in a cut section, add the volume of excavation then subtract the volume of embankment plus shrinkage at each consecutive station until the two numbers are equal. (See [Equation 35.2.4.](#)) Interpolation must be used.
2. If the balance begins in a fill section, the procedure is reversed (i.e., embankment plus shrinkage minus excavation). Interpolation must be used.

$$B = (V_1 + V_2) - (V_3 \times S) \quad (\text{Equation 35.2.4})$$

Where:

B = Running balance, CY
 V1 = Cut volume of the first section, CY
 V2 = Cut volume of the second section, CY
 V3 = Fill volume of the first section, CY
 S = Shrinkage factor

Once the cross sectional areas have been determined and volumes computed in accordance with the instructions in [Section 35.2.2](#), the results are documented on the Earthwork Computation Sheet. The Earthwork Computation Sheet depicts the method of recording the volumes of earthwork and tracking the balance between cut and fill until the values equal 0; hence, the balance point is achieved. This balance station represents a point along the alignment where the amount of excavation (i.e., cut) is equal to the amount of embankment (i.e., compacted fill) required. Several balance points may occur on one project.

* * * * *

Example 35.2(2)

Given: Project Length = 1878 feet
 Beginning of Project = Station 0 + 10
 End of Project = Station 18 + 88
 Shrinkage Factor = 30 percent

Problem: Compute the balance points on the project. Begin with determining the first balance point station by developing a running balance from the beginning point. Use [Figure 35.2B](#) as a guide in calculating the balance points for this example.

Solution:

1. Compute the volumes of the fill and cut.

Using [Equation 35.2.1](#), Station 1 + 00 requires 398 cubic yards of cut and 0 cubic yards of fill. Record this value in the far right column on the Earthwork Computation Sheet as shown in [Figure 35.2B](#).

Using [Equation 35.2.1](#), Station 1 + 50 requires 235 additional cubic yards of cut and 1 cubic yard of fill.

2. Compute the running balance between the cut and fill.

$$B = (398 \text{ CY} + 235 \text{ CY}) - (1 \text{ CY} \times 1.30) = 632 \text{ CY}$$

The 1.30 factor is the shrinkage factor. Record this value in the far right column on the Earthwork Computation Sheet as shown in [Figure 35.2B](#).

3. Continue this procedure for the rest of the Stations for excavation and embankment (see [Figure 35.2B](#)).

$$(632 \text{ CY} + 43 \text{ CY}) - (35 \text{ CY} \times 1.30) = 629 \text{ CY}$$

4. After computing all of the volumes, the balance point can be observed to be somewhere between station 4 + 00 and 4 + 50 (i.e., the point at which a balance of 0 exists). Because the project begins with excessive excavation and is gradually being equalized by the accumulated volume of fill, a total amount of cut is documented between stations 0 + 10 and 4 + 50 equal to the value of 796 CY as shown in the Excavation Balanced Cut column. To achieve an equal amount of compacted fill, a value of 612 CY is required as shown in the Embankment Balanced Fill column (i.e., 612 CY X 1.30 = 796 CY).

When the embankment volume values between Stations 0+10 and 4+50 are accumulated using the same procedure as in [Number 2](#) above, it yields 484 CY. This indicates that at station 4 + 00, the project is 128 CY short of having an exact balance.

$$612 \text{ CY} - 484 \text{ CY} = 128 \text{ CY short}$$

5. Adding the next embankment volume value of 231 CY to the previous accumulated embankment value of 484 CY, it indicates an excess of 103 CY beyond a balance.

$$484 \text{ CY} + 231 \text{ CY} = 715 \text{ CY embankment volume}$$

$$715 \text{ CY} - 612 \text{ CY} = 103 \text{ CY excess}$$

6. To compute the station at which a true balance of 0 exists, determine the proportional value between the required amount to obtain a balance (i.e., 128 CY) and the available volume of embankment material in the next section (i.e., 231 CY). Multiply the fractional value times the immediate increment for the cross sections (i.e., Station 4 + 00 to Station 4 + 50 = 50 feet).

$$\frac{128 \text{ CY}}{231 \text{ CY}} \times 50 \text{ FT} = 27.8 \text{ FT}$$

Add this distance to Station 4 + 00 to achieve the point at which a balance equals 0.

$$\text{Station } 4 + 00 + 27.8 \text{ FT} = \text{Station } 4 + 27.8$$

7. The 103 cubic yards of excess is multiplied by the shrinkage factor and documented as embankment

$$103 \text{ CY} \times 1.30 = 134 \text{ CY}$$

8. Compute the next beginning point by taking the embankment value at the next station (Station 5 + 00) and multiplying it by the shrinkage factor. Add the compacted volume carry-over found in Step 7 above.

$$(231 \text{ CY} \times 1.3) + 134 \text{ CY} = 434 \text{ CY carry over to the next section.}$$

9. Use this number of 434 cubic yards to continue as above to solve for the next balance point.

$$5,612 \text{ CY} = (4,317 \text{ CY} \times 1.30) + 4,317 \text{ CY}$$

Note that excavation (cut) and embankment (fill) values are documented and computed separately. The values from [Figure 35.2A](#) for cut and fill (end areas and volumes) correspond to the values in [Figure 35.2B](#) between stations 1 + 00 and 3 + 00. Also note that the project is in balance. The total excavation volume of 5612 cubic yards equals the total embankment volume of 4317 cubic yards plus the 30 percent shrinkage value as shown in [Figure 35.2B](#).

The solution of the same sample problem may be performed by a computer program (the Department uses GEOPAK). Earthwork calculations are documented by summarizing the computer values at the balance points and the project termini.

* * * * *

35.2.5 Borrow Excavation

During the Design Field Review, the District Construction Engineer makes a recommendation as to whether the contractor or Department will furnish borrow pits for any unclassified excavation and base (borrow) materials that may be required. If the Department elects to provide borrow pits on a project, the overhaul will be computed and listed in the Summary of Estimated Quantities. If the Department elects to have the borrow pits provided by the contractor, overhaul will not be a pay item on the project.

Where an entire project has 25 cubic yards or less of borrow material, it will be itemized as Unclassified Excavation. When there is 26 cubic yards or more of borrow material, it will be itemized as Borrow Excavation.

35.2.6 Removal and Disposal of Existing Asphalt Pavement

Removal and disposal of existing asphalt pavement that is 2 inches in thickness or greater is measured and paid for by the square yard and itemized as Removal and Disposal of Existing Asphalt Pavement. All existing asphalt pavement that is less than 2 inches is paid for as Unclassified Excavation.

35.2.7 Removal and Disposal of Existing Pavement

Removal and disposal of existing pavement includes concrete pavement, concrete sidewalk, stone or concrete curbs, concrete curb and gutter, and brick sidewalk. It is measured and paid for by the square yard and itemized as Removal and Disposal of Existing Pavement.

35.3 ROADWAY QUANTITIES

35.3.1 Base Course

35.3.1.1 Widening

Asphalt aggregate base course is typically used on projects that are widened 6 feet or less.

When widening with a different base material other than used for the overlay, calculate an extra 6 inches of width for the base course beyond the edge of the surface course.

When widening the existing pavement with the same material for the base and for the overlay (e.g., asphalt concrete surface course), do not calculate the typical extra 6 inches of width for the base course.

35.3.1.2 Sand Clay Base Course

Unless specifically requested otherwise and agreed upon during the Design Field Review, the contractor is required to furnish all materials and incidentals necessary to construct sand clay base courses in accordance with the *Standard Specifications*. In order to avoid conflicts during contract preparation and administration, all roads that use sand clay base course in the same project are required to essentially have the same material composition. The Program Manager must approve any necessary changes to insure uniformity in the contract.

Equation 35.3.1 is used to calculate the area of the base course needed in square yards.

$$A = (D \times W) \times \frac{1 \text{ SY}}{9 \text{ SF}} \quad (\text{Equation 35.3.1})$$

Where: A = the area of the base, SY
 D = the distance between sections, FT
 W = the width of the base, FT

Example 35.3(1)

Given: Station 0 + 11 to Station 29 + 04
 Width of Base = 29 feet (28 foot traveled way + 6 inches on each side)
 Inclusion for Drives = 100 square yards (calculated)

Problem: Compute the estimated quantity of Sand Clay Base Course for the roadway.

Solution:

1. Compute the distance.

$$D = \text{Station } 29 + 04 - \text{Station } 0 + 11 = 2,893 \text{ FT}$$

2. Compute the area using [Equation 35.3.1](#).

$$A = (2,893 \text{ FT} \times 29 \text{ FT}) \times \frac{1 \text{ SY}}{9 \text{ SF}} = 9,322 \text{ SY}$$

3. Include the areas for the driveways.

$$9,322 \text{ SY} + 100 \text{ SY} = 9,422 \text{ SY}$$

35.3.1.3 Graded Aggregate Base Course

When the Design Field Review team recommends a graded aggregate base course, the contract will not include an alternative except for the following counties; Darlington, Dillon, Florence, Georgetown, Horry, Marion, Marlboro and Williamsburg. Coquina shell base will be used as an alternative in these counties.

Earthwork quantities in the Plans are for graded aggregate base course. If coquina shell base is selected, the grades will be adjusted in the field to compensate for the difference in base thickness. The quantities for Unclassified Excavation and Borrow Excavation will be adjusted prior to final payment. A note will be placed on the General Construction Note Sheet when coquina shell base course is used.

Example 35.3(2)

Given: Project Termini = Station 0 + 13 to Station 55 + 52
 Width of Roadway = 23 feet (22 feet + 6 inches on each side)
 Inclusion for Drives = 75 square yards (calculated)

Problem: Compute quantity of Graded Aggregate Base Course.

Solution:

1. Compute the distance.

$$D = \text{Station } 55 + 52 - \text{Station } 0 + 13 = 5,539 \text{ FT}$$

2. Compute the area using [Equation 35.3.1](#).

$$A = (5,539 \text{ FT} \times 23 \text{ FT}) \times \frac{1 \text{ SY}}{9 \text{ SF}} = 14,155 \text{ SY}$$

3. Include Areas for Driveways.

$$14,155 \text{ SY} + 75 \text{ SY} = 14,230 \text{ SY}$$

When setting up quantities of base material for drives in the inclusions, use only the term “Graded Aggregate Base Course” in lieu of stating all three alternatives. The depth of base material is shown in the inclusions.

35.3.1.4 Portland Cement for Base Course

Portland cement is a bid item that must be computed and accounted for in the Summary of Estimated Quantities when the Plans specify the use of Cement Modified Subbase, Cement Stabilized Earth Base Course and/or Cement Stabilized Aggregate Base Course. These base courses are computed and paid for in square yards and the Portland cement quantity used in these base courses is computed and paid for in tons.

Use the following procedure for computing the quantities of Portland Cement:

1. Obtain the appropriate “D” factor (density of soils) from the Research and Materials Engineer.
2. Obtain the appropriate percentage factor for Portland Cement ratio for each base course in the project.
3. Figure the estimated quantities by applying [Equation 35.3.3](#) and the following steps:
 - a Convert plan quantities of the base courses noted above from square yards to cubic feet.
 - b Compute the product of cubic feet of material, the density of material (D), and the ratio (percentage) of cement to the item.
 - c Convert the answer found in Step b. above to tons by dividing by 2,000.

$$\text{Ton} = (V \times D \times \%) \times \frac{1 \text{ TON}}{2,000 \text{ LBS}} \quad (\text{Equation 35.3.2})$$

Where: V = Volume of Base Course, CF
 D = Density of Material, LBS/CF
 % = Percent by Weight of Cement

Example 35.3(3)

Given: Cement Stabilized Earth Base Course – 6 inches Uniform = 3,900 square yards
 Density of Material = 125 pounds per cubic foot (from Lab)
 Percentage of Cement by Weight = 6 percent

Problem: Compute the estimated quantity of Cement Stabilized Earth Base Course – 6 inches Uniform.

Solution:

1. Convert square yards to square feet by multiplying by 9. Multiply by the depth (6 inches uniform) of mix to get the volume in CF.

$$3,900 \text{ SY} \times \frac{9 \text{ SF}}{1 \text{ SY}} \times 0.5 \text{ FT} = 17,550 \text{ CF}$$

2. Use [Equation 35.3.2](#) to solve for estimated quantity.

$$17,550 \text{ CF} \times \frac{125 \text{ LBS}}{1 \text{ CF}} \times 0.06 \times \frac{1 \text{ TON}}{2,000 \text{ LBS}} = 65.81 \text{ TON}$$

35.3.1.5 Prime Coat

The prime coat is calculated and added to the list of estimated quantities for projects using graded aggregate base course and sand clay base course. The rate of application is 0.27 gallon per square yard. When computing the square area, include the entire width of the base course.

$$P = A \times R \quad (\text{Equation 35.3.3})$$

Where: P = Volume of prime coat, GAL
 A = Area of base course, SY
 R = Rate of application for prime coat, GAL/SY

Example 35.3(4)

Given: Area for Base Course = 14,155 square yards (from [Example 35.3\(2\)](#))
Rate of Application = 0.27 gallon per square yard

Problem: Compute the estimated quantity of the Prime Coat.

Solution:

Use [Equation 35.3.3](#).

$$14,155 \text{ SY} \times \frac{0.27 \text{ GAL}}{1 \text{ SY}} = 3,822 \text{ GAL of prime coat}$$

35.3.1.6 Hot Mix Asphalt Aggregate Base Course

The rate of application for hot mix asphalt aggregate base course is given on the Design Field Review or in the pavement design.

Example 35.3(5)

Given: Station 0 + 13 to Station 55 + 52
Width of Roadway = 23 feet
Rate of Application = 800 pounds of hot mix asphalt per square yard

Problem: Compute the estimated quantity for Hot Mix Asphalt Aggregate Base Course Type 1.

Solution:

1. Compute the distance.

$$\text{Station } 55 + 52 - \text{Station } 0 + 13 = 5,539 \text{ FT}$$

2. Compute the area using [Equation 35.3.1](#).

$$A = (5,539 \text{ FT} \times 23 \text{ FT}) \times \frac{1 \text{ SY}}{9 \text{ SF}} = 14,155 \text{ SY}$$

3. Multiply the area times the rate of application and convert square yards to tons.

$$14,155 \text{ SY} \times \frac{800 \text{ LBS}}{1 \text{ SY}} \times \frac{1 \text{ TON}}{2000 \text{ LB}} = 5,662 \text{ TON}$$

35.3.2 Flexible Pavements

35.3.2.1 Hot Mix Asphalt Binder Course

This course consists of a binder or intermediate course composed of mineral aggregate and asphalt binder. The rate of application for the binder course is given on the Design Field Review or in the pavement design.

Example 35.3(6)

Given: Station 0 + 13 to Station 55 + 52
 Width of Binder = 22 feet
 Rate of Application = 225 pounds binder per square yard
 Overruns = 5 percent
 Build-up for Binder Course = 50 tons

Problem: Compute the quantity Hot Mix Asphalt Binder Course.

Solution:

1. Compute the distance.

$$\text{Station } 55 + 52 - \text{Station } 0 + 13 = 5,539 \text{ FT}$$

2. Compute the area using [Equation 35.3.1](#).

$$A = (5,539 \text{ FT} \times 22 \text{ FT}) \times \frac{1 \text{ SY}}{9 \text{ SF}} = 13,540 \text{ SY}$$

3. Multiply the area times the rate of application and convert square yards to tons.

$$13,540 \text{ SY} \times \frac{225 \text{ LBS}}{1 \text{ SY}} \times \frac{1 \text{ TON}}{2000 \text{ LBS}} = 1,523 \text{ TON}$$

4. Add build-up for binder course.

$$1,523 \text{ TON} + 50 \text{ TON} = 1,573 \text{ TON}$$

5. Add overruns.

$$(1,573 \text{ TON} \times 0.05) + 1,573 \text{ TON} = 1,652 \text{ TON}$$

* * * * *

35.3.2.2 Liquid Asphalt Binder in Paving Mixture

Liquid asphalt binder is included for all asphalt paving mixtures. [Figure 35.3A](#) provides the recommended values in computing these quantities. See the latest Instruction Bulletin “Guidelines for Hot Mix Asphalt Selection Table” for the specific binder to be used.

* * * * *

Example 35.3(7)

Given: 1273 Tons of ACSC Type 1 Surface Course.

Problem: Compute the estimated quantity of Liquid Asphalt Binder required.

Solution: Multiply the appropriate percentage provided in [Figure 35.3A](#).

$$1273 \text{ TON} \times 0.06 = 7.64 \text{ TONS Liquid Asphalt Binder}$$

* * * * *

Type Asphalt Mix	Recommended % Asphalt Binder
Type 1C Surface Course	5.3%
Types 1 & 3 Surface Course	6.0%
Types 4 & 5 Surface Course	6.3%
Type 1 Binder Course	5.0%
Type 2 Binder Course	5.1%
Type 1 Asphalt Aggregate Base Course	4.2%
Type 2 Asphalt Aggregate Base Course	4.3%
Surface for Shoulders	6.0%
Superpave Surface Course	5.1%
Superpave Intermediate Course	4.3%
Open Graded Friction Course	6.5%

LIQUID ASPHALT BINDER PERCENTAGES

Figure 35.3A

35.3.2.3 Full Depth Asphalt Pavement Patching

Full depth asphalt pavement patching is limited to a uniform depth of 4, 6 and 8 inches. Problems occur in the curing and compaction of the asphalt mix in patches deeper than 8 inches. An estimated quantity of Aggregate CR14 should be included for stabilizing the patch area below the designated depth.

35.3.2.4 Asphalt Weight and Thickness

Figure 35.3B provides conversion factors for the weight and thickness of asphalt base and surface courses.

35.3.2.5 Hot Mix Asphalt Surface Course

Recommendations from the Design Field Review or the pavement design will provide the rate of application for the surface course.

Type 1C is used on all Federal-aid, non-Interstate projects and selected State projects where a high volume of trucks exist. Specify a minimum of 150 pounds per square yard when Type 1C is used. Use Superpave on all Interstate projects.

The decision for specifying the Type 1C surfacing on State projects will be determined on a project-by-project basis during the Design Field Review.

Material Type	LBS/SY (approximate) 1 inch thick	Equivalent inches/100 LBS/SY
Hot Mix Asphalt Concrete Surface Course	105.0	0.95
Hot Mix Asphalt Concrete Binder Course	105.0	0.95
Hot Mix Asphalt Aggregate Base Course	105.0	0.95

CONVERSION FACTORS FOR HOT MIX ASPHALT MATERIALS

Figure 35.3B

* * * * *

Example 35.3(8)

Given: Station 0 + 13 to Station 55 + 52 = 5,539 feet
 Traveled Way Width = 22 feet
 Inclusion for Drives = 66 tons
 Rate of Application = 175 pounds of Hot Mix Asphalt per square yard
 Overruns = 2 percent

Problem: Compute the estimated quantity for Hot Mix Asphalt Surface Course.

Solution:

1. Compute the area and convert to square yards.

$$A = (5,539 \text{ FT} \times 22 \text{ FT}) \times \frac{1 \text{ SY}}{9 \text{ SF}} = 13,540 \text{ SY}$$

2. Convert square yards to tons.

$$13,540 \text{ SY} \times \frac{175 \text{ LBS}}{1 \text{ SY}} \times \frac{1 \text{ TON}}{2,000 \text{ LBS}} = 1,185 \text{ TON}$$

3. Include the quantity for driveways.

$$1,185 \text{ TON} + 66 \text{ TON} = 1,251 \text{ TON}$$

4. Include overruns.

$$(1,251 \times 0.02) + 1,251 = 1,276 \text{ TON}$$

* * * * *

35.3.2.6 Bituminous Surfacing

The type of bituminous surfacing for surface course is provided in the Design Field Review or on the pavement design.

* * * * *

Example 35.3(9)

Given: Station 0 + 11 to Station 29 + 04 = 2,893 feet
 Traveled Way Width = 28 feet
 Inclusions for Drives = 500 square yards

Problem: Compute the estimated quantity for the surfacing.

Solution:

1. Compute the area and convert to square yards.

$$A = 2,893 \text{ FT} \times 28 \text{ FT} \times \frac{1 \text{ SY}}{9 \text{ SF}} = 9,000 \text{ SY}$$

2. Include the area for the driveways.

$$9,000 \text{ SY} + 500 \text{ SY} = 9,500 \text{ SY}$$

35.3.2.7 Rigid Pavements

Portland cement concrete pavements are uniform thickness as determined by the Research and Materials Laboratory and are paid for in square yards.

35.4 TRAFFIC ITEMS

The road designer is generally not responsible for calculating the quantities for traffic items. For assistance in traffic related calculations, contact the Traffic Engineering Division.

35.4.1 Pavement Markings for Two-Lane Bridge Plans

All bridge projects that require road plans developed by the Road Design Section will include pavement markings in the Roadway Summary of Estimated Quantities. Unless the project is particularly complex, the road designer will determine the pavement markings. If assistance is required, contact the Traffic Engineering Division. Pay items generally are those listed in the following Sections.

35.4.1.1 Pavement Edge Lines

Determine the quantity of the pavement edge lines by doubling the total length of the project and itemize as 4" White Solid Lines (Pvt. Edge Lines) F.D. Paint.

35.4.1.2 Broken Yellow Lines

Assume half of the total project length is broken yellow lines. Determine the quantity by taking half the total approach length and divide by four. The result should be rounded up to be divisible by 10. Itemize as 4" Yellow Broken Lines (Gaps Exc.) F.D. Paint.

35.4.1.3 Pavement Edge Lines and No Passing Zone

Assume half the total project length will be double yellow on the centerline. Determine the quantity by taking half times the total approach length and double to accommodate for each side of the centerline. Itemize as 4" Yellow Solid Lines (Pvt. Edge & No Passing Zone) F.D. Paint.

35.4.1.4 Raised Pavement Markers

Permanent yellow pavement markers are for projects with design speeds greater than 45 miles per hour or if existing roadway has pavement markings in place at the time of the Design Field Review. They are placed on the centerline and itemized as Permanent Yellow Pavement Markers Bi-Dir, Refl. 4" x 4". See the *SCDOT Standard Drawings* to determine the estimated quantity.

35.5 DRAINAGE

The designer should be knowledgeable of all drainage policy criteria affecting other elements of roadway design (e.g., establishing final profiles in flood plains, culvert headwater control, bridge freeboard at major stream crossings). Storm drainage design, culvert design, hydraulic data required on Roadway/Bridge Plans and other drainage criteria are addressed in the Department's *Requirements for Hydraulic Design Studies*, which is available on the SCDOT website.

35.5.1 Riprap

The Department uses multiple classes of riprap that are described in the *Standard Specifications for Highway Construction*. All notes in the Plans pertaining to riprap should describe the quantity and class of riprap used.

Where the Hydraulic Engineering Section specifies a specific class of riprap, the class is placed on the Plans at each location. If a hydraulic study is not performed, the Road Design Group may make recommendations for the class of riprap.

The following provides the procedure for computing the quantity of riprap, in tons, around bridge ends:

1. Use [Equation 35.5.1](#) and [Figure 35.5A](#).

$$\text{Area} = (2z + 2x + y)(A) \quad \text{Equation 35.5.1}$$

Where: $x = \frac{2\pi R}{4}$, distance of curve at corner of bridge, FT

$$\text{Where: } R = \left[\frac{(a-b)}{2} + (c-a) \right] d, \text{ FT}$$

y = shoulder to shoulder width, FT

z = slope distance, use 2 times the height of fill or a minimum of 30 FT

$$A = \sqrt{(a-b)^2 + ((a-b)d)^2}$$

Where: A = width of riprap, FT

a = top of riprap (high water elev. + 2.0 FT), FT

b = bottom of riprap (ground line elev. - 2.0 FT), FT

c = shoulder line elevation, FT

d = slope of fill, FT

2. Calculate the depth of riprap by multiplying 2 times D_{50} . Use a minimum of 1 foot. D_{50} is the diameter of the particle size in which 50 percent of the material is smaller.
3. Calculate the volume of the riprap, in cubic yards, by multiplying the calculated area by the depth of riprap and dividing by 27 cubic feet.
4. Convert the cubic yards of riprap to tons where 1 cubic yard of riprap equals 3400 pounds and multiply by the number of approaches.

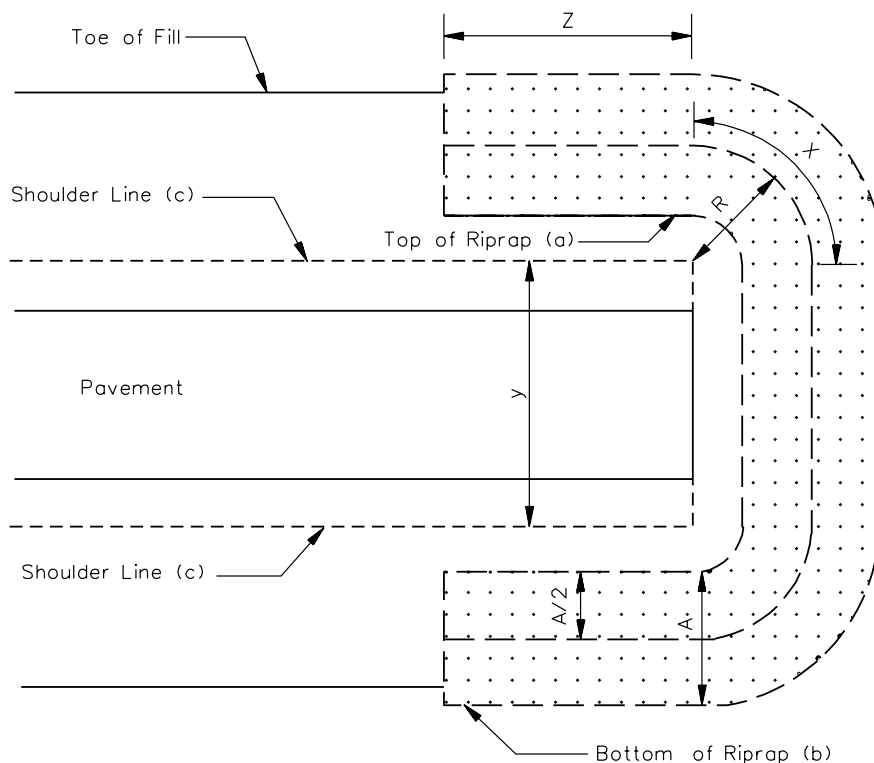

METHOD FOR COMPUTING RIPRAP AT BRIDGE ENDS
Figure 35.5A

Example 35.5(1)

Given: $a = 529.81 + 2.0 = 531.81$ feet
 $b = 516.0 - 2.0 = 514.0$ feet
 $c = 545.0$
 $d = 2H:1V$, slope = 2
 $y = 41$ feet

Problem: Compute the quantity of Riprap needed at bridge ends.

Solution:

1. Compute A.

$$A = \sqrt{(a-b)^2 + ((a-b)d)^2} = \sqrt{(531.81 - 514.0)^2 + ((531.81 - 514.0)(2))^2}$$

$$= 39.824 \text{ SF}$$

2. Compute R.

$$R = \left[\frac{(a-b)}{2} + (c-a) \right] (d) = \left[\frac{(531.81 - 514.0)}{2} + (545.0 - 531.81) \right] (2) = 44.2 \text{ FT}$$

3. Compute x.

$$x = \frac{2\pi R}{4} = \frac{(2(\pi))(44.2)}{4} = 69.39 \text{ FT}$$

4. Compute D.

$$D = (2)(D_{50}) = 1 \text{ FT}$$

Note: Use a minimum D of at least 1 foot.

5. Compute the area of the riprap and convert to a volume of riprap in cubic yards.

$$\text{Area} = (2(30) + 2(69.39) + 41) (39.824) = 239.78 \times 39.824 = 9549 \text{ SF}$$

$$\text{Volume} = 9,549 \text{ SF} \times 1 \text{ FT} \times \frac{1 \text{ CY}}{27 \text{ CF}} = 353.7 \text{ CY}$$

6. Convert cubic yards to tons and multiply times the number of approaches.

$$353.7 \text{ CY} \times \frac{3400 \text{ LBS}}{1 \text{ CY}} \times \frac{1 \text{ TON}}{2000 \text{ LBS}} = 601 \text{ TON}$$

$$601 \text{ TON} \times 2 \text{ (approaches)} = 1,202 \text{ TON}$$

When both approaches are a different height, each approach is figured separately.

The following and [Example 35-5\(2\)](#) provide the procedures for computing riprap, in tons, for a ditch:

1. Determine the length of the ditch.
2. Calculate the perimeter of the ditch cross section.

$$P = B + 2D\sqrt{Z^2 + 1}$$

(Equation 35.5.2)

Where: P = perimeter, FT
 B = base of ditch, FT
 D = depth of ditch, FT
 Z = rate of sideslope of ditch

Note: This procedure can also be used to calculate riprap for a V-ditch by setting B equal to 0.

3. Select the depth of the riprap. Assume a minimum depth of at least 1 foot.
4. Multiply the perimeter by the depth to get the cross-sectional area.
5. Multiply the cross-sectional area by the length of the ditch to obtain the volume of the riprap.
6. Convert the volume of the riprap to tons.

Example 35.5(2)

Given: A flat-bottom ditch with side slopes of 2H:1V and a bottom width of 4 feet is constructed from Station 221 + 00 to Station 227 + 00.

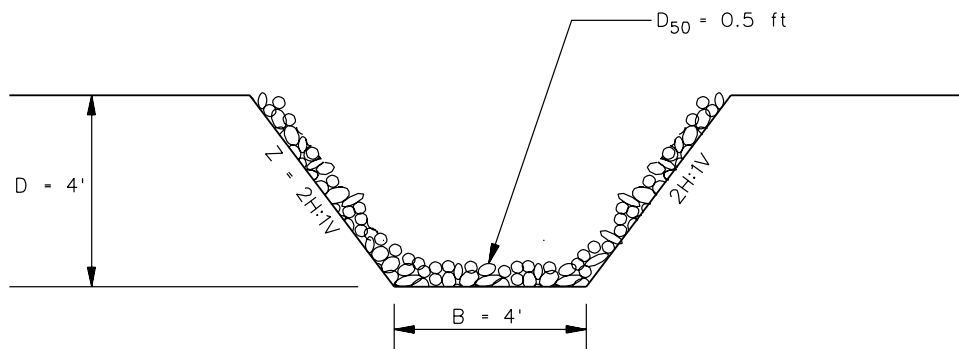

FLAT BOTTOM DITCH

Figure 35.5B

Problem: Compute the necessary quantity of Riprap, in tons.

Solution:

1. Compute the length of the ditch.

$$\text{STA. 227 + 00} - \text{STA. 221 + 00} = 600 \text{ FT}$$

2. Compute the perimeter of the ditch.

$$\begin{aligned} P &= B + 2D\sqrt{Z^2 + 1} = 4 + 2(4)\sqrt{2^2 + 1} \\ &= 21.9 \text{ ft} \end{aligned}$$

3. Compute the volume of the riprap, in cubic feet.

$$\text{Volume} = P \times L \times (2 \times D_{50})$$

$$\text{Volume} = 21.9 \text{ FT} \times 600 \text{ FT} \times (2 \times 0.5 \text{ FT}) = 13,140 \text{ CF}$$

4. Convert cubic feet of riprap to tons.

$$13,140 \text{ CF} \times \frac{1 \text{ CY}}{27 \text{ CF}} \times \frac{3400 \text{ LBS}}{1 \text{ CY}} \times \frac{1 \text{ TON}}{2000 \text{ LBS}} = 827 \text{ TON}$$

35.5.1.2 Hand Placed Riprap

Unless otherwise specified on the Plans, hand placed riprap is Class B. When specified, Class A may be placed by hand.

35.5.1.3 Dumped Riprap

Dumped riprap may be Class A, B, C, D, E or F and is shown on the Plans. In the event that the class for dumped riprap is not indicated on the Plans, it can be assumed to be Class C.

35.5.1.4 Foundation Riprap

The class for foundation riprap is designated on the Plans.

35.5.1.5 Geotextile

Geotextile for erosion control is to be used under all riprap. Figure 35.5C provides a map that depicts the regional types of geotextile used by the Department. Type D Geotextile is a site-specific type in both class of geotextile and is only used in critical to severe applications. More site-specific information is given in the Special Provisions when Type D is required. The soil retention Apparent Opening Size (AOS) and permittivity must be obtained either from the pavement design or the Research and Materials Laboratory.

35.5.2 Crossline Pipe

All crossline pipes are concrete. Where beveled end sections are used, consider the usable length of a beveled end section to figure the length of pipe required to span the fill. However, the beveled end sections are bid separately

All beveled end sections of RC pipe are 8 feet long with varying lengths of solid pipe. For estimating purposes, the usable lengths are provided in Figure 35.5D.

Diameter (inches)	Usable Length (feet)
15	6
18	5
24	4
30	3
36, 42, 48	2

USABLE LENGTHS OF RC PIPES

Figure 35.5D

* * * * *

Example 35.5(3)

To span a fill, 32 feet of 18-inch RC pipe is to be added to existing RC pipe. Because two beveled end sections of 18-inch RC pipe yields 10 feet of usable pipe, the contractor only needs 22 feet of 18-inch RC pipe. Round 22 feet to 24 feet to make the length divisible by four. Place the following note on the Plans:

ADD (or Place) 24' - 18" RC PIPE AND PLACE 2 - 18" BEVELED END SECTIONS.

* * * * *

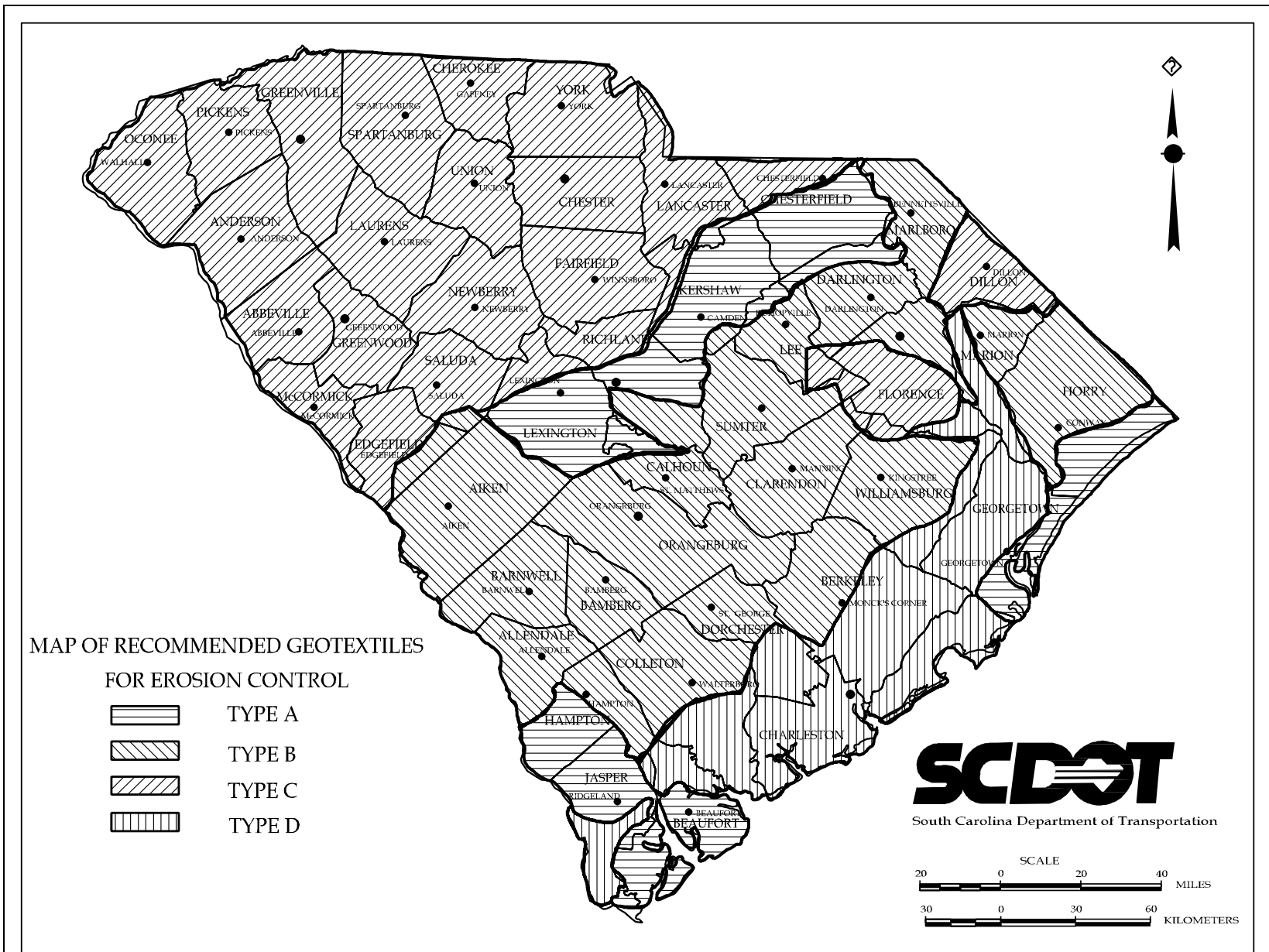

MAP OF RECOMMENDED GEOTEXTILES FOR EROSION CONTROL

Figure 35.5C

35.5.3 Sideline Pipe

Sideline installations with beveled end sections may be bid by one of the following methods:

1. RC Pipe, or
2. Alternative RC Pipe, Corrugated Polyethylene (HDPE) Pipe or Corrugated Aluminum Alloy Pipe.

If Method 1 is used, the same procedure for estimating crossline pipe as detailed in [Section 35.5.2](#) should be used. If Method 2 is used, the total length of pipe including the beveled end section and the length of non-usable pipe must be considered. For estimating purposes, the non-usable lengths are as given in Figure 35.5E:

Diameter (inches)	Non-Usable Length (feet)
15	2
18	3
24	4
30	5
36, 42, 48	6

NON-USABLE LENGTHS OF VARIOUS RC BEVELED END PIPES

Figure 35.5E

Example 35.5(4)

The length of 15-inch pipe needed for a drive is 28 feet. Because two beveled end sections of 15-inch RC pipe yields 4 feet of non-usable pipe, the contractor needs 32 feet, see [Figure 35.5F](#). Place the following note in the Plans:

PLACE 32' – 15" ALT. PIPE WHICH INCLUDES 2 – 15" BEVELED END SECTIONS.

If alternative sideline pipes are used, it is recommended to itemize them as follows:

- ALT I 18" RC Pipe Culvert (Class III) (Incl. 8 Beveled End Sections) 200 L.F.
- ALT II 18" HDPE (*Thickness*) (Incl. 8 Beveled Ends) 200 L.F.
- ALT III 18" Corr. Alum Alloy Culv. Pipe (*Thickness*) (Incl. 8 Beveled Ends) 200 L.F.

Place the following note in the Plans:

PLACE 32' – 18" PIPE INCL. 2 EACH 18" BEVELED END SECTIONS.

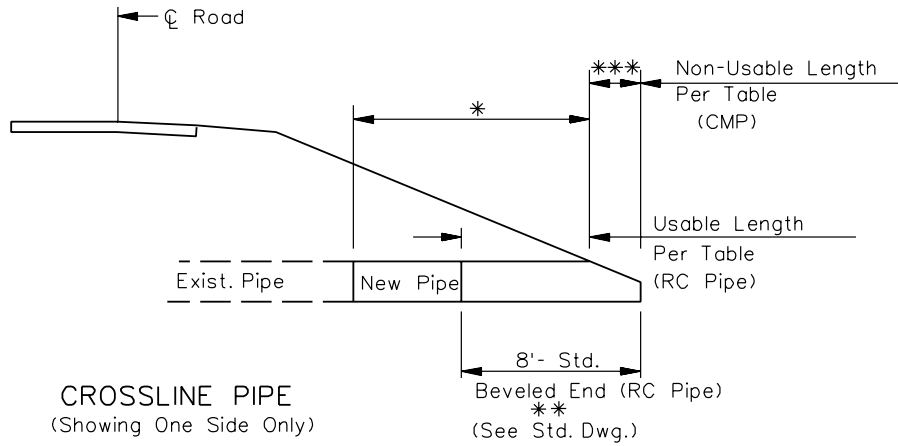

- * Initial Length of Pipe Required
Computed Between These Limits
 - ** Excluded from Calculations
for RC Pipe
 - *** Included in Calculations for
HDPE & Aluminum Alloy Pipe
- CMP - Corrugated Metal Pipe
(Includes Steel & Aluminum Alloy Pipe)

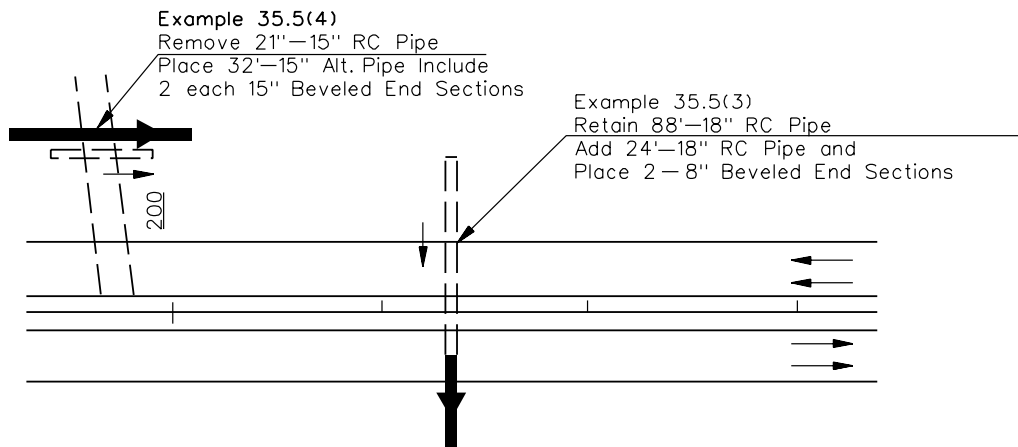

LAYOUT SHOWING METHOD USED FOR WORK DESCRIPTION

BEVELED PIPE END DATA

Figure 35.5F

35.5.4 Erosion and Sediment Control Best Management Practices

Erosion control Best Management Practices (BMP) consist of materials, structures and construction methods that minimize the adverse impacts of the movement of water over the project site. Sediment control BMP consist of materials, structures and construction methods that trap and minimize the adverse impacts of eroded soil particles. In typical construction applications, these erosion and sediment control BMP are temporary measures.

Land development should be planned to control and limit erosion and sediment discharges from construction sites using BMP. The goals of erosion and sediment control BMP are to:

- minimize the extent and duration of disturbed soil exposure;
- protect off-site and downstream locations, drainage systems and natural waterways from the impacts of erosion and sedimentation;
- limit the exit velocities of the flow leaving the site to non-erosive or pre-development conditions; and
- design and implement an ongoing inspection and maintenance plan.

The SCDOT will not pay for BMP that are not constructed and maintained according to *SCDOT Standard Drawings*.

35.5.4.1 Erosion Control BMP

35.5.4.1.1 Final Stabilization with Permanent Seeding

The use of native species is preferred when selecting vegetation. Seedbed preparation, seed type, application rate, fertilizer rate and planting windows should be selected according to site specific soil testing. All projects should have a pay item for final stabilization including Seeding (MSY), Fertilizer (TON), Lime (TON) and Nitrogen (LBS). Additional quantities may be given in the inclusions for locations not specified on the Final Construction Plans.

If a stand of permanent vegetation has less than 40 percent cover, re-evaluate the choice of plant materials and quantities of lime and fertilizer. Re-establish the stand following seedbed preparation, seeding recommendations, lime application recommendations and fertilizer application recommendations according to soil test results. If the season prevents re-sowing, use mulch or temporary seeding as a temporary cover.

Seeded areas should be kept adequately moist. Irrigate the seeded area if normal rainfall is not adequate for the germination and growth of seedlings. Water seeded areas at controlled rates that are less than the rate at which the soil can absorb water to prevent runoff.

Final stabilization of the site requires that it be covered by a 70 percent coverage rate. This does not mean that 30 percent of the site can remain bare. The coverage is defined as looking at a square yard of coverage, in which 70 percent of that square yard is covered with vegetation.

Determine the estimated quantities for permanent seeding using the following equations.

1. Seeding.

$$S = (S_1 \times W) \times \frac{1 \text{ SY}}{9 \text{ FT}^2} \times \frac{1}{1000} \quad (\text{Equation 35.5.2})$$

Where: S = Seeding, MSY
 S₁ = Seeding, FT
 W = Average Width, FT

2. Fertilizer.

$$F = F_1 \times \frac{1 \text{ Acre}}{4,840 \text{ SY}} \times \frac{1,000 \text{ LBS}}{1 \text{ Acre}} \times \frac{1 \text{ TON}}{2,000 \text{ LBS}} \quad (\text{Equation 35.5.3})$$

Where: F = Fertilizer, TON
 F₁ = Fertilizer, SY (S₁ x W from [Equation 35.5.2](#))

3. Lime.

$$L = L_1 \times \frac{2,000 \text{ LBS}}{1 \text{ Acre}} \times \frac{1 \text{ TON}}{2,000 \text{ LBS}} \quad (\text{Equation 35.5.4})$$

Where: L = Lime, TON
 L₁ = Lime, Acres (F₁ × $\frac{1 \text{ Acre}}{4,840 \text{ SY}}$ from [Equation 35.5.3](#))

4. Nitrogen.

$$N = N_1 \times \frac{48 \text{ LBS}}{1 \text{ Acre}} \quad (\text{Equation 35.5.5})$$

Where: N = Nitrogen, LBS
 N₁ = Nitrogen, Acres (L₁ from [Equation 35.5.4](#))

35.5.4.1.2 Temporary Seeding

The purpose of temporary seeding is to reduce erosion and sedimentation by stabilizing disturbed areas that would otherwise lay bare for long periods of time before they are worked or stabilized. Temporary seeding is also used where permanent vegetation is not necessary or appropriate. All projects should have a pay item for Temporary Seeding and Seeding (MSY), Fertilizer (TON), Lime (TON) and Nitrogen (LBS). Additional quantities may be given in the inclusions for locations not specified on the Final Construction Plans.

Temporary seeding can be used on exposed soil surfaces (e.g., denuded areas, soil stockpiles, dikes, dams, banks of sediment basins and traps and temporary road banks. Temporary seeding has the potential to prevent or limit costly maintenance operations on other sediment control structures. Sediment clean-out requirements for sediment basins, sediment, traps and silt fence can be reduced if temporary seeding is applied where grading and construction operations are not taking place.

Seeded areas should be amended with fertilizer and covered with mulch to provide protection from the weather. If the vegetation does not grow quickly or thick enough to prevent erosion, the area should be re-seeded as soon as practical. Seeded areas should be kept adequately moist. Irrigate the seeded area if normal rainfall is not adequate for the germination and growth of seedlings. Water seeded areas at controlled rates that are less than the rate at which the soil can absorb water to prevent runoff.

All projects should include a quantity for temporary seeding. This quantity is necessary because the National Pollutant Discharge Elimination System (NPDES) regulations require all disturbed areas to be seeded within seven days. The Program Manager determines the amount of seeding required at the Design Field Review (e.g., 25 percent or 50 percent of permanent seeding). The disturbed area on a project is shown in acres on the Title Sheet in a box labeled NPDES. The acreage is determined by multiplying the length of the project by the width of the construction line/right of way lines less any existing pavement to be retained. If construction slopes extend beyond the right of way line, this area will be added along with outfall ditches and drainage that extends beyond the mainline right of way. An example of the NPDES line is shown in [Section 30.3.3](#).

Determine the estimated quantities for temporary seeding using the following equations:

1. Seeding.

$$MS = S \times 0.25 \quad \text{(Equation 35.5.6)}$$

Where: MS = Mulched Seeding, MSY
 S = Seeding, MSY (from Equation 35.5.2)

2. Fertilizer.

$$F_2 = F \times 0.125 \quad \text{(Equation 35.5.7)}$$

Where: F_2 = Temporary Seeding Fertilizer (mulched), TON

F = Fertilizer, TON (from [Equation 35.5.3](#))

Example 35.5(4)

Given: Project Length = 3,120 feet
 Right of Way Width = 66 feet
 Outfall Ditch Length = 300 feet
 Outfall Ditch Width = 30 feet
 Construction Slopes = 360 feet
 Existing Pavement Length = 450 feet
 Existing Pavement Width = 22 feet

Problem: Compute the area to be seeded for the NPDES regulation.

Solution:

1. Compute the project area in acres.

$$3,120 \text{ FT} \times 66 \text{ FT} \times \frac{1 \text{ ACRE}}{43,560 \text{ SF}} = 4.727 \text{ ACRES}$$

2. Compute the outfall ditch area.

$$300 \text{ FT} \times 30 \text{ FT} \times \frac{1 \text{ ACRE}}{43,560 \text{ SF}} = 0.207 \text{ ACRE}$$

3. Convert construction slopes to acres.

$$360 \text{ SF} \times \frac{1 \text{ ACRE}}{43,560 \text{ SF}} = 0.008 \text{ ACRE}$$

4. Compute pavement area in acres.

$$450 \text{ SF} \times 22 \text{ FT} \times \frac{1 \text{ ACRE}}{43,560 \text{ SF}} = 0.227 \text{ ACRE}$$

5. Add Steps 1 through 3 and subtract Step 4.

$$4.727 + 0.207 + 0.008 - 0.227 = 4.715 \text{ Total NPDES ACRES.}$$

35.5.4.1.3 Rolled Erosion Control Products

Rolled Erosion Control Products (RECP) are used for temporary or permanent stabilization of soils where final grade has been constructed. RECP are installed immediately following permanent seeding. All RECP applications should be shown on the Final Construction Plans. These plans should have a pay item for RECP (SY) and additional quantities may be given in the inclusions for locations not specified on the Final Construction Plans.

All bridge projects must have the pay item for RECP included in the estimated quantities. Include in the calculated quantities for the entire fill slope adjacent to the bridge back to the termini of the project or to a cut section.

Where the roadway grade is 2.5 percent or greater, a quantity for RECP should be computed to cover the roadway ditches at a minimum width of 10 feet (i.e., 5 feet for each side of the bottom of the ditch). See the *SCDOT Standard Drawings*.

RECP are classified into two separate categories:

1. Temporary Erosion Control Blankets. These blankets are composed primarily of biologically, photochemically or otherwise degradable constituents with a longevity of approximately 1 to 3 years. Non-organic, photodegradable or biodegradable netting is permitted. They provide temporary protection because they degrade over time as the vegetation becomes established. Some products are effective for a few months while others degrade slowly and are effective for a few years.
2. Turf Reinforcement Mattings (TRM). TRM are non-degradable products composed of non-degradable constituents with an unlimited longevity. They enhance the ability of living plants to stabilize soils and bind with roots to reinforce the soil matrix. TRM have been divided into three separate classes (i.e., Types 1, 2 and 3) in order to accommodate different design conditions.

TRM are used in situations where vegetation alone will not hold a slope, ditch line or stream bank. TRM enable the use of "green" solutions in many areas where only "hard" solutions (e.g., riprap or concrete linings) were viable in the past.

The actual type of RECP installed, is based on design slopes, maximum flow velocities and maximum shear stresses. The design engineer will note the type and class of RECP to be installed on the Plans. The contractor should then select an appropriate RECP from the SCDOT approved products list.

35.5.4.1.4 Diversion Dikes

Diversion dikes are used to divert upslope clean water runoff from crossing areas where there is a high risk of erosion. Diversion dikes may be constructed as ridges of compacted soil only, or may have an upstream ditch (excavated depression). Diversion dikes can be either temporary or permanent storm water control structures. All Diversion dikes should be shown on the Final Construction Plans. These plans should have a pay item for Diversion Dikes (LF) and additional quantities may be given in the inclusions for locations not specified on the Final Construction Plans. When RECP are used in conjunction with diversion dikes, the RECP should have a separate pay item. See the *SCDOT Standard Drawings*.

Diversion dikes are generally built around the perimeter of a construction site before any major disturbing activity takes place. Where constructed along the upslope perimeter of disturbed or high-risk areas, these clean water diversions prevent clear water runoff from flowing over unprotected down slope areas. Diversion dikes should be stabilized immediately using vegetation and RECP to prevent erosion.

Insure the upslope side of the dike provides positive slope, but not too much slope that could cause erosion due to high runoff flow velocities. Temporary diversion dikes should remain in place until the downstream area to be protected is permanently stabilized.

35.5.4.1.5 Temporary Silt Ditches

Temporary silt ditches are used to divert sediment-laden runoff to appropriate sediment control BMP. All temporary silt ditches should be shown on the Final Construction Plans. These plans should have a pay item for Temporary Silt Ditches (CY) and additional quantities may be given in the inclusions for locations not specified on the Final Construction Plans. Include an additional pay item for the Removal and Disposal of Deposited Sediment (CY) in silt ditches. See the *SCDOT Standard Drawings*.

Temporary silt ditches are generally built around the perimeter of a construction site before any major disturbing activity takes place. Temporary silt ditches located on the down slope side of a disturbed or high-risk area will prevent sediment-laden runoff from leaving the site before the sediment is properly removed. For longer slopes, several silt ditches may be placed across the slope at intervals. This practice reduces the amount of runoff that accumulates on the face of the slope and carries the runoff safely down the slope. In all cases, runoff is guided to sediment trapping BMP with stabilized outfalls before release.

35.5.4.1.6 Pipe Slope Drains

Pipe slope drains are used to reduce the risk of erosion when it is necessary for water to flow down a slope without causing erosion, especially before a slope has been stabilized or before permanent drainage structures are installed. Pipe slope drains can be temporary or permanent depending on the installation and the pipe material used. All pipe slope drain applications should be shown on the Final Construction Plans. These plans should have a pay item for Pipe Slope Drains (LF) and additional quantities may be given in the inclusions for locations not specified on the Final Construction Plans. See the *SCDOT Standard Drawings*.

Temporary pipe slope drains, usually flexible tubing or conduit, may be installed prior to construction of permanent drainage structures. Permanent pipe slope drains should be buried beneath the soil surface a minimum of 1.5 feet. The inlets and outlets of pipe slope drains should be stabilized with flared end sections, RECP or riprap. The soil around the pipe entrance should be fully compacted to prevent bypassing or undercutting of the structure. The soil at the discharge end of the pipe should be stabilized along the bottom of any swales that lead to sediment trapping structures or other stabilized areas.

Typical pipe slope drains are made of non-perforated corrugated plastic pipe designed to pass the peak flow rates for the 10-year, 24-hour storm event. The maximum drainage area allowed per pipe slope drain should be limited to 2 acres. If the pipe slope drain is conveying sediment-laden water, all flows should be directed to a sediment trapping BMP.

Determine estimated quantities for pipe slope drains:

$$D = M \times \frac{400 \text{ FT}}{1 \text{ MI}} \quad (\text{Equation 35.5.9})$$

Where: D = Pipe Slope Drain, LF
M = Project length, MI

35.5.4.1.7 Anionic Polyacrylamides (PAM)

Anionic polyacrylamides (PAM) are non-toxic chemicals used for controlling soil erosion and sedimentation on construction sites by acting as temporary soil binding agents. This temporary practice is intended for direct soil surface application on sites where the establishment of vegetation may not be feasible or where vegetative cover is absent or inadequate. Anionic PAM are available in emulsions, powders, gel bars or logs. It is recommended that other BMP be used in combination with anionic PAM. The use of seed and mulch for additional erosion protection beyond the life of the anionic PAM is required. All PAM applications should be shown on the Final Construction Plans.

These plans should have a pay item for Anionic PAM (MSY). This pay item should include the PAM and the mobilization and operation of the application equipment. Additional quantities may be given in the inclusions for locations not specified on the Final Construction Plans.

Not all polymers are erosion control PAM and site specific PAM should be used for each application. Only use anionic forms of PAM because cationic PAM are toxic. Follow the manufacturer's guidelines when applying PAM. If PAM treated soils are left undisturbed with no vegetative cover, reapplication may be necessary after 6 to 8 weeks. Further anionic PAM applications may be required for disturbed areas including highly silty and clayey soils, steep slopes, long grades, high traffic or high precipitation areas.

35.5.4.1.8 Riprap or Aggregate

The preferred method of slope and channel protection is the use of vegetation. If vegetation cannot withstand the design slopes, flows and shear stresses, RECP are the preferred and suggested method of protection. When conditions are too severe for vegetation and TRM, riprap may be used for erosion control and protection. Riprap may be used, as appropriate, at storm drain outlets, on channel banks and/or bottoms, drop structures, at the toe of slopes, and in transitions from concrete channels to vegetated channels. All riprap applications should be shown on the Final Construction Plans. These plans should have a pay item for Riprap (TON) and additional quantities may be given in the inclusions for locations not specified on the Final Construction Plans.

Riprap is a permanent, erosion-resistant aggregate consisting of large, loose, angular stone with a filter fabric or granular underlining. The purpose of riprap is to:

- protect the soil from the erosive force of concentrated runoff; and
- slow runoff velocities while enhancing the potential for infiltration.

The purpose of the filter fabric or granular underlining is to prevent undermining of the riprap layer by the migration of soil particles under seepage forces through the riprap.

35.5.4.2 Sediment Control BMP

All sediment control BMP should be designed to have an 80 percent design removal efficiency goal of the total suspended solids (TSS) or 0.5-mL/L peak settleable concentration, whichever is less. This efficiency should be calculated for the disturbed construction condition for the 10-year, 24-hour storm event. There are computer software packages available that may be used to calculate the removal efficiencies of sediment control BMP. In addition, Appendix E of the *South Carolina Stormwater Management and Sediment Control Handbook for Land Disturbing Activities* (DHEC 1995) titled "Engineering Aids and Design Guidelines for Control of Sediment in South Carolina" can be used in calculating sediment removal efficiencies.

35.5.4.2.1 Temporary Sediment Basin

Temporary sediment basins should be used on sites where 10 or more disturbed acres drain to a single point. A temporary sediment basin should not be built in wetlands, any active or live streams, or in Waters of State (defined to be all annual or perennial water bodies designated by a solid or dashed blue-line on USGS 7.5-minute quadrangle maps). Temporary sediment basins should be used until the contributing flow areas to the basin have undergone final stabilization.

All temporary sediment basins should be shown on the Final Construction Plans with a rectangle having the longest dimension in the direction of the flow. Sediment basins should be numbered on the Plans and these numbers should be transferred to the Erosion Control Data Sheet. The required design information should be provided for each individual sediment basin. When showing sediment basins on the Plans, it will be necessary to show any additional right of way (temporary or permanent) required to install these structures. This procedure should be done prior to sending the Plans to Right of Way Office. The detailed drawings for sediment basins must be included in the Final Construction Plans with the Erosion Control Data Sheet, as applicable. If comments need to be recorded on the Erosion Control Data Sheet, use the line or lines directly under the item being referenced. These plans should have a pay item for each Temporary Sediment Basin shown on the Plans.

Drop inlet spillways, pipe spillways, rock fill outlets and weir spillways may be used for the design of the principal spillway. Temporary sediment basins that are readily accessible to populated areas should incorporate all possible safety precautions such as signs and fencing. The inside pond slopes should be no steeper than 2H:1V where applicable. See the *SCDOT Standard Drawings*.

The key to a functional sediment basin is continual monitoring, regular maintenance and regular sediment removal. Attention to sediment accumulations within the pond is extremely important. Sediment deposition should be continually monitored in the basin. Remove sediment when it reaches 50 percent of storage volume or reaches the top of the designed cleanout stake where applicable. The removed sediment should be removed from or stabilized on site. Disturbed areas resulting from the removal of the sediment basin should be permanently stabilized.

35.5.4.2.2 Multipurpose Basins

Multipurpose basins are permanent detention basins that are designed for use as temporary sediment basins during the construction phase of a project. Two spillway configurations are commonly used in the life of a multipurpose basin. The first configuration is the sediment basin spillway, which is typically a corrugated metal pipe (CMP) riser and reinforced concrete pipe (RCP) barrel configuration. This configuration makes the most sense because the CMP riser section can be removed and the RCP

barrel section can be used as part of the spillway for the permanent detention basin spillway.

Design the principal spillway for the permanent detention phase to reduce post-development flows to pre-development flows for the 2- and 10-year, 24-hour storm event. Design the emergency spillway to pass and provide flow reduction for the 100-year detention basin using post-development conditions.

When the sediment pond phase has expired, the temporary riser structure should be removed and the permanent structure should be installed. The basin should be cleaned of deposited sediment, regraded to meet the permanent basin contours and stabilized with vegetation and RECP where necessary.

35.5.4.2.3 Temporary Sediment Dam

A temporary sediment dam is formed by excavating a pond or by placing an earthen embankment across a low area or drainage swale. An outlet or spillway is constructed using stones or aggregate to slow the release of runoff. The trap retains the runoff long enough to allow eroded sediment to settle out. Temporary sediment dams should be used until the contributing flow areas to the basin have undergone final stabilization.

All temporary sediment dams should be shown on the Final Construction Plans. Sediment dams should be numbered on the Plans and these numbers should be transferred to the Erosion Control Data Sheet. The required design information should be provided for each individual sediment dam. When showing sediment dams on the Plans, it will be necessary to show any additional right of way (temporary or permanent) required to install these structures. This procedure should be done prior to sending the Plans to the Right of Way Office. The detailed drawings for sediment dams must be included in the Final Construction Plans with the Erosion Control Data Sheet, as applicable. If comments need to be recorded on the Erosion Control Data Sheet, use the line or lines directly under the item being referenced. All projects should have a pay item for each Temporary Sediment Dam shown on the Plans. The pay item should include:

- Silt Basin (CY), the Silt Basin pay item includes the construction and clean out of the temporary sediment dam;
- Aggregate No. 5 Stone for Erosion Control (SY);
- Sediment Dam Riprap (TON); and
- Geotextile for Erosion Control under Riprap (SY).

A sediment dam may be formed completely by excavation or by construction of a compacted embankment. The outlet should be a rock fill weir/spillway section, with the area below the weir acting as a filter for sediment and the upper area as the overflow spillway depth. The sediment dam may have an excavated silt basin upstream of the

rock fill spillway. If it does not, then the variable "Depth of Silt Basin" will be zero and "N/A" should be placed in the length and width boxes of the Erosion Control Data Sheet. The sediment dam silt basin may be drained and must be so noted on the Erosion Control Data Sheet. If the outfall channel of a sediment dam does not require protection, indicate by placing a zero under "Outfall Channel Length" and "N/A" in the other applicable boxes of the Erosion Control Data Sheet. See the *SCDOT Standard Drawings*.

Temporary sediment dams should not be placed in Waters of the State or USGS blue-line streams (unless approved by State or Federal authorities). Install a non-woven geotextile filter fabric before installing the stone for the outlet structure. Allow the stone to extend downstream past the toe of the embankment. All sediment dam slopes should be 2H:1V or flatter. The sediment cleanout level of a sediment dam should be marked with a stake in the field. Seed and mulch all disturbed areas after installation.

The key to a functional sediment dam is continual monitoring, regular maintenance and regular sediment removal. Remove sediment when it reaches 50 percent of storage volume or top of cleanout stake. Trapped sediment should be removed from or stabilized on site.

All temporary sediment dams should be removed within 30 days after final site stabilization is achieved or after it is no longer needed. Disturbed areas resulting from the removal of the sediment trap should be permanently stabilized.

35.5.4.2.4 Silt Fence

Silt fencing is a temporary sediment control measure consisting of posts with filter fabric stretched across the posts. The lower edge of the fence is vertically trenched and covered by compacted backfill. The location of all silt fence applications should be shown on the Final Construction Plans. These plans should have a pay item for Silt Fence (LF) and additional quantities may be given in the inclusions for locations not specified on the Final Construction Plans. See the *SCDOT Standard Drawings*.

The maximum sheet or overland flow path length to a silt fence should be 100 feet and the maximum slope steepness, normal (perpendicular) to the fence line, should be 2H:1V. Silt fences should not be placed across channels or areas that receive concentrated flows.

35.5.4.2.5 Rock Ditch Checks

Rock ditch checks are small, temporary or permanent rock fill dams constructed across drainage ditches, swales or channels to lower the speed of concentrated flows. All rock ditch checks should be shown on the Final Construction Plans. These plans should

have a pay item for Rock Ditch Checks (TON). This pay item should include the removal and disposal of the rock ditch checks. Additional quantities may be given in the inclusions for locations not specified on the Final Construction Plans. The removal of collected sediment from rock ditch checks should have a pay item for the Removal and Disposal of the Sediment (CY). See the *SCDOT Standard Drawings*.

Only use rock ditch checks in small open channels. Do not place the checks in Waters of the State or USGS blue-line streams (unless approved by State or Federal authorities). Install geotextile filter fabric under all rock ditch checks.

Straw Bales are not permitted for this purpose.

Spacing varies with the bed slope of the ditch. The maximum spacing between rock ditch checks should be such that the toe of the upstream check is at the same elevation as the top of the downstream check. In the case of grass-lined ditches and swales, rock ditch checks should be removed when the grass has matured sufficiently to protect the ditch or swale unless the slope of the swale is greater than 4 percent. The area beneath the rock ditch checks should be seeded and mulched immediately after dam removal.

35.5.4.2.6 Storm Drain Inlet Protection

Storm drain inlet protection can be achieved by placing a temporary filtering device around any inlet to trap sediment. These BMP prevent sediment from entering inlet structures. Additionally, they serve to prevent the silting-in of inlets, storm drainage systems or receiving channels.

The four different materials/methods suggested to provide inlet protection are:

- Filter Fabric Inlet Protection,
- Block and Gravel Drop Inlet Protection,
- Wire Mesh and Stone Inlet Protection, and
- Pre-Fabricated Inlet Protection BMP.

Straw Bales are not permitted for this purpose.

Inlet protection may be installed prior to the construction of roads. Inlet protection is required on all inlets that have outfalls that bypass sediment trapping BMP and directly discharge off-site. Storm drain inlet protection is not appropriate as the only BMP for drainage areas exceeding 1 acre or to control large concentrated storm water flows.

Sediment should be removed when it reaches approximately 1/3 the height of inlet protection structures. If a sump is used, sediment should be removed when it fills

approximately 1/3 the depth of the hole. Maintain the pool area, always providing adequate sediment storage volume for the next storm.

Storm drain inlet protection structures should be removed only after the disturbed areas are permanently stabilized. Remove all construction material and sediment and dispose of them properly. Grade the disturbed area to the elevation of the drop inlet structure crest. Use appropriate permanent stabilization methods to stabilize bare areas around the inlet. Consider the following:

1. Filter Fabric Inlet Protection. Filter fabric is used for inlet protection for small storm water flows (0.5 cubic feet per second or less) with low velocities and where the inlet drains a relatively flat area (slopes no greater than 5 percent). This practice cannot be used where inlets are paved or where inlets receive concentrated flows such as in streets or highway medians. All filter fabric inlet protection structures should be shown on the Final Construction Plans. These plans should have a pay item for each Filter Fabric Inlet Protection Structure (EA). Additional quantities may be given in the inclusions for locations not specified on the Final Construction Plans. The removal of collected sediment from filter fabric inlet protection structures should have a pay item for the Removal and Disposal of the Sediment (CY). See the *SCDOT Standard Drawings*.
2. Block and Gravel Inlet Protection. Block and gravel inlet filters can be used where heavy flows and higher velocities are expected and where an overflow capacity is necessary to prevent excessive ponding around the structure. Gravel should consist of 1-inch D₅₀ washed stone and should extend to a height equal to the elevation of the top of the blocks. All block and gravel inlet protection structures should be shown on the Final Construction Plans. These plans should have a pay item for each Block and Gravel Inlet Protection Structure (EA). Additional quantities may be given in the inclusions for locations not specified on the Final Construction Plans. The removal of collected sediment from block and gravel inlet protection structures should have a pay item for the Removal and Disposal of the Sediment (CY). See the *SCDOT Standard Drawings*.
3. Wire Mesh and Stone Inlet Protection. Supported wire material with filter stone can be used where concentrated flows may be expected. Hardware cloth or comparable wire mesh with maximum 1/2-inch openings should be used as the supporting material. The stone should consist of 1-inch D₅₀ washed stone, extend to a minimum height of 12 inches and should not exceed 24 inches. All wire mesh and stone inlet protection structures should be shown on the Final Construction Plans. These plans should have a pay item for each Wire Mesh and Stone Inlet Protection Structure (EA). Additional quantities may be given in the inclusions for locations not specified on the Final Construction Plans. The removal of collected sediment from wire mesh and stone inlet protection

structures should have a pay item for the Removal and Disposal of the Sediment (CY). See the *SCDOT Standard Drawings*.

4. Pre-Fabricated Inlet Protection BMP. To encourage the development and testing of pre-fabricated inlet protection BMP, alternative management practices may be allowed upon review and approval. To use pre-fabricated inlet protection BMP, the design professional should submit substantial evidence that the proposed measure will perform adequately. Evidence may include, but is not limited to:
- supporting hydraulic and trapping efficiency calculations,
 - peer-review by a panel of licensed professional engineers,
 - research results as reported in professional journals, and/or
 - manufacturer literature.

To justify the efficiency of pre-fabricated inlet protection BMP, SCDOT may monitor the trapping efficiency of the BMP. If satisfactory results showing that trapping efficiencies of greater than 80 percent are obtained, the pre-fabricated inlet protection BMP may be used and no other monitoring studies should be required. If monitoring shows that a certain pre-fabricated inlet protection BMP is not sufficient or if SCDOT finds that a pre-fabricated inlet protection BMP fails or is inadequate to contain sediment, other upstream and downstream BMP may be required to reach the required performance.

These projects should have a pay item for each Pre-Fabricated Inlet Protection BMP (EA). Additional quantities may be given in the inclusions for locations not specified on the Final Construction Plans. The removal of collected sediment from pre-fabricated inlet protection BMP should have a pay item for the Removal and Disposal of the Sediment (CY). See the *SCDOT Standard Drawings*.

35.5.4.2.7 Rock Sediment Dikes

Rock sediment dikes are semi-circular temporary sediment control BMP constructed across drainage ditches, swales, low areas or other areas that receive concentrated flow to provide sediment control. A rock sediment dike consists of a half-circular shaped rock embankment with a sump area constructed for sediment storage. Rock sediment dikes are most effective in areas where sediment control is needed with minimal disturbance. They can be used as sediment control BMP for the outfalls of diversion dikes, in low areas or other areas where concentrated sediment laden flow is expected.

All rock sediment dikes should be shown on the Final Construction Plans. Rock dikes should be numbered on the Plans and these numbers should be transferred to the Erosion Control Data Sheet. The required design information should be provided for each individual rock dike. When showing rock sediment dikes on the Plans, it will be

necessary to show any additional right of way (temporary or permanent) required to install these structures. This procedure should be done prior to sending the Plans to Right of Way Office. The drawings for rock dikes must be included in the Final Construction Plans with the Erosion Control Data Sheet, as applicable. If comments need to be recorded on the Erosion Control Data Sheet, use the line or lines directly under the item being referenced. All projects should have a pay item for each Rock Dike shown on the Plans. The pay item should include:

- Silt Basin (CY), the Silt Basin pay item includes the construction and clean out of the rock sediment dike;
- Aggregate No. 5 Stone for Erosion Control (SY);
- Rock Sediment Dike Riprap(TON); and
- Geotextile for Erosion Control under Riprap (SY).

Rock sediment dikes should be used for drainage areas no greater than 2 acres. Rock sediment dikes should not be placed in Waters of the State or any other streams that have a base flow (unless approved by State or Federal authorities). A non-woven geotextile fabric should be installed over the soil surface where the rock sediment dike is to be placed. The body of the rock sediment dike should be composed of minimum 9-inch D_{50} riprap. The upstream face of the rock sediment dike should be composed of a 1-foot thick layer of $\frac{3}{4}$ - to 1-inch D_{50} washed stone placed at a slope of 2H:1V. See the *SCDOT Standard Drawings*.

The key to a functional rock sediment dike is continual monitoring, regular maintenance and regular sediment removal. Remove sediment when it reaches 50 percent of the sediment storage volume or when it reaches the top of the cleanout stake. Removed sediment from the sump should be removed from or stabilized on site.

All rock sediment dikes should be removed within 30 days after final site stabilization is achieved or after they are no longer needed. Disturbed areas resulting from the removal of rock sediment dikes should be permanently stabilized.

35.6 MISCELLANEOUS ITEMS

35.6.1 Guardrail

35.6.1.1 Guardrail End Treatment

All projects that have guardrail end treatments are identified in the Plans as an End Treatment – Type T. The contractor selects a terminal listed from the Approval Sheet for End Terminal – Type T maintained by the Research and Materials Engineer. The *SCDOT Roadside/Median Barriers and End Treatments, NCHRP 350* presents the pay limits for the various approved end treatments.

35.6.1.2 Paving Under Guardrail

Currently, paving under guardrail has been authorized for Interstate and selected State projects. The cost of this practice is reviewed periodically to determine its continuance.

35.6.2 Underground Storage Tanks

There are three pay items for underground storage tanks:

- Removal and Disposal of Tank Contents,
- Removal and Disposal of Low Level Contaminated Soil, and
- Removal and Disposal of High Level Contaminated Soil.

For additional information on underground storage tanks, see [Section 34.2.3.2.3](#).

35.6.3 Driveways

35.6.3.1 General

Driveway changes, additions or new driveways should be shown on the Plans only if locations have been pre-determined by the Program Manager. Existing driveways need to be shown. The graded aggregate base course for new driveways is constructed with a minimum thickness (or depth) of 4 inches. When specifying graded aggregate base course, convert to equivalent square yards of the nominal thickness dimension (8 inches or 6 inches) of graded aggregate base course as specified in the Roadway Summary of Estimated Quantities. Include this note in the General Construction Notes. Other alternatives (e.g., asphalt concrete) may be used as directed by the Project Engineer.

Driveways should be constructed in accordance with the *SCDOT Standard Drawings* and the Department's publication, *Standards for Driveway Entrances to Highways*.

Where projects require sidewalk construction (or improvements are proposed in areas with sidewalk), driveways are constructed of concrete and appropriate quantities are included in the Plans.

Where concrete sidewalk is called for on a project with driveways, a quantity for Concrete Driveway at a uniform depth of 6 inches is included for all driveways. See the *SDOT Standard Drawings* for details.

35.6.3.2 Maintenance of Roadway and Driveways During Construction

Where material is needed to maintain traffic on the roadway or on driveways during construction, the bid item Maintenance Stone (TON) is used. Materials used to maintain driveways during construction must meet the requirements of the *Standard Specifications* and are placed in the inclusions.

In addition, when full depth patching is required, the quantity for maintenance stone is 25 tons per 100 square yards.

35.6.3.3 Pipe Under Driveways

The following pipe quantities are required for driveways during construction:

- a minimum length of 24 feet of pipe is provided for each standard driveway;
- additional pipe of various sizes may be shown in the Plans as an inclusion item. This is determined during the Design Field Review; and
- a change in pipe length is determined by the Resident Construction Engineer.

In all instances, show proposed drive pipe sizes and lengths on the Plans.

35.6.4 Aggregate Underdrain

A quantity of aggregate underdrain is calculated and included for pipe underdrains of all sizes in accordance with the *Standard Specifications*. For this purpose, fine aggregate (FA-12 or FA-13) is specified and used to backfill the trench above the minimum amount of required course aggregate placed with the pipe underdrain.

Fine aggregate is calculated in accordance with the rates listed below:

- 4 inches – 100 cubic yards per 1,000 linear feet of Pipe Underdrain
- 6 inches – 130 cubic yards per 1,000 linear feet of Pipe Underdrain
- 8 inches – 150 cubic yards per 1,000 linear feet of Pipe Underdrain

35.6.5 Fences or Walls

On all highway projects existing fences or walls within the construction area or right of way that are constructed of materials other than standard fence materials (i.e., chain link or woven wire) are set up as Moving Items, to be removed or reconstructed, as appropriate. These fences or walls typically consist of brick, concrete block, rail, wrought iron or another type of decorative material.

Where re-setting fences is necessary and the type of fence is chain link, it should be specified as Reset Chain-Link Fence while Reset Fence is adequate for all other types. Reset & New Fence is shown in linear feet in the General Construction Notes and on the Roadway Summary of Estimated Quantity Sheet.

35.6.6 Shrubs and Plants

On "C" projects, it is important that the number of shrubs and plants being relocated is set up as Moving Items and is itemized as accurately as practical. In an effort to achieve this, the designer obtains the quantity for those items that can be readily discerned. In areas where a reasonable count can be obtained, the Moving Item will contain a number, accompanied by the notation "approximate." When encountering an area where the designer cannot obtain a reasonable count of the plants, the Moving Item is designated by "all desirable plants, adjacent to the new right of way, be moved clear of the new right of way."

35.6.7 Seeding and Sodding

The Design Field Review determines the seeding types, mulched or unmulched, and the sodding. When appropriate, a bid item is set up for seeding when it is expected that the contractor will disturb an area that would subsequently require reseeding.

35.6.8 Mowing

Generally, mowing is included on all projects except bridge replacement projects. Also, other projects that have only a small quantity of seeding may not need a mowing quantity. These projects will be identified on the Design Field Review and a decision will be made whether to include mowing. Quantities will be determined by the amount of total seeding and/or sodding in the Plans, including temporary seeding.

35.6.9 Bridges

Bridges should be accurately drawn on plan sheets and flagged with a note that shows the length, type (e.g., precast, prestressed, reinforced concrete) and project termini.

New right of way should be 75 feet on each side of the centerline and extended for 75 feet beyond the beginning and ending stations of the bridge. This may be varied at the discretion of the Program Manager.

Include all applicable guardrail notes.

The profile should show the bridge thickness with an elevation shown at both ends of the bridge. Also show the toe of fill stations and slopes of fill under the bridge. If riprap is to be placed along the toe of fill, include the notes for the riprap. Also, include the hydrology data and high watermark. Omit the earthwork from the toe of fill to toe of fill.

In some cases, it may be necessary to remove portions of old fill. Show this by cross-hatching and itemize as Unclassified Excavation.

On bridge replacement projects, the Bridge Design Section is responsible for determining the need for Construction Stakes, Lines and Grades, or As-Built Construction Plans bid items. The Bridge Design Section enters these pay items into the system and shows them on the Bridge Plans as applicable.

35.6.9.1 Concrete Transition Curb and Flume At Bridge Ends

The designer will use concrete transition curb and flume at bridge ends with a paved shoulder area on all bridge ends, except where bridge concrete curb and gutter with flume is provided in the bridge plans; see the *SCDOT Standard Drawings*. Bridge concrete curb and gutter with flumes will be used on the left and right side at the low end of the bridge when the grade is greater than or equal to 1 percent.

Use concrete transition curb and flume on all bridge ends where the Bridge Plans do not show the bridge concrete curb and gutter with flumes. On the high side of superelevated sections, only the concrete transition curbs and paved shoulder areas will be constructed. The flume and riprap will not be placed on the high side of superelevated sections.

Where the bridge end drainage is determined by the road designer, use the *SCDOT Standard Drawings* to determine the pay items and quantities needed. Be aware of the two types of bridge ends — with and without a bridge approach slab.

In addition, include 3 linear feet of 9 x 15 inch-concrete curb for each corner of the bridge using the concrete transition curb in the inclusions. The Engineer will determine the manner in which to use the concrete curb.

35.6.9.2 Brick Masonry and Reinforced Brick Masonry Walls

The following procedure should be used when the Project Development Team has selected a brick masonry wall. Where the top of a brick masonry wall has elevation breaks, the top can be contoured to give the top of wall a pleasing contoured look at the request of the Program Manager. During the Design Field Review, the type and design of the brick wall will be determined. Where a wall is desired, the Road Design Group must request a review of the selected design by the Roadway Structures Design Group. The Roadway Structures Design Group will verify the use of the proposed brick wall and may request the Research and Materials Laboratory to provide soil borings, if deemed necessary. After the Roadway Structures Design Group verifies the design, the Road Design Group should complete calculating the quantities for the selected wall. If the selected wall does not meet the design conditions shown on the *SCDOT Standard Drawings* (e.g., over 10 feet high or extraordinary live or dead loads), the Road Design Group should use a wall designed by the Roadway Structures Design Group.

* * * * *

Example 36.6(1)

Given: Brick Wall Length = 400 feet
 Brick Wall Dimensions = 4 FT x 1 FT (height x width)
 Back Slope = level

Problem: Compute the Brick Masonry and Concrete quantities.

Solution:

1. Compute the volume of the wall.

$$400 \text{ FT} \times 1 \text{ FT} \times 4 \text{ FT} = 1,600 \text{ CF}$$

2. Compute the brick masonry in cubic yards.

$$1,600 \text{ CF} \times \frac{1 \text{ CY}}{27 \text{ CF}} = 59.26 \text{ CY}$$

3. Obtain the values for the footing dimensions from the table in the *SCDOT Standard Drawings* – Concrete Class 3000 = 3 feet-2 inches wide and 10 inches high. Calculate the volume of concrete.

$$400 \text{ FT} \times 3.167 \text{ FT} \times 0.833 \text{ FT} = 1,055 \text{ CF}$$

$$400 \text{ FT} \times 0.229 \text{ FT} \times 0.667 \text{ FT} = 61 \text{ CF}$$

$$1,055 \text{ CF} + 61 \text{ CF} = 1,116 \text{ CF of Class 3000 Concrete}$$

4. Convert cubic feet of concrete to cubic yards.

$$1,116 \text{ CF} \times \frac{1 \text{ CY}}{27 \text{ CF}} = 41.34 \text{ CY of Class 3000 Concrete}$$

Example 36.6(2)

Given: Reinforced Brick Wall
 Length = 400 feet
 Dimensions = 5 FT x 1 FT (height x width)
 Back Slope < 4H:1V

Problem: Compute the quantity of the Reinforced Brick Masonry and Concrete.

Solution:

1. Compute the volume of brick masonry.

$$400 \text{ FT} \times 1 \text{ FT} \times 5 \text{ FT} = 2,000 \text{ CF}$$

2. Convert to cubic yards.

$$2,000 \text{ CF} \times \frac{1 \text{ CY}}{27 \text{ CF}} = 74.08 \text{ CY}$$

3. Obtain the footing dimensions for Concrete Class 3000 from the table in the *SCDOT Standard Drawings* – footing width = 3 feet - 6 inches wide. Calculate the concrete volume used for the footings.

$$400 \text{ FT} \times 3.5 \text{ FT} \times (12 \text{ IN}/12 \text{ IN}) = 1,400 \text{ CF}$$

$$400 \text{ FT} \times (2.75 \text{ IN}/12 \text{ IN}) \times (8 \text{ in}/12 \text{ in}) = 61 \text{ CF}$$

$$1,400 \text{ CF} + 61 \text{ CF} = 1,461 \text{ CF}$$

4. Convert concrete volume to cubic yards.

$$1,461 \text{ CF} \times \frac{1 \text{ CY}}{27 \text{ CF}} = 54.11 \text{ CY of Class 3000 concrete}$$

Grout and reinforcing steel used in the wall and foundation is shown on the *SCDOT Standard Drawings* and no separate quantities are calculated.

35.7 REFERENCES

1. *Standard Specifications for Highway Construction*, SCDOT, Current Edition.
2. *Book of Standard Drawings for Road Construction*, SCDOT, Current Edition.
3. *A Policy on Geometric Design of Highways and Streets*, AASHTO.

Table of Contents

<u>Section</u>	<u>Page</u>
36.1 PROGRAMING ESTIMATES	36.1(1)
36.1.1 TIP/STIP Inclusion	36.1(1)
36.1.2 Post Public Hearing.....	36.1(1)
36.1.3 Right of Way Plans.....	36.1(2)
36.1.4 Construction Plans	36.1(2)
36.1.5 Procedures for Developing Cost Estimates.....	36.1(3)
36.2 ENGINEER's ESTIMATE	36.2(1)
36.2.1 Responsibilities	36.2(1)
36.2.1.1 Design Units.....	36.2(1)
36.2.1.2 Specifications and Estimates Group	36.2(2)
36.2.2 Estimating Procedures	36.2(2)
36.2.3 Estimating Guidelines	36.3(3)

Chapter Thirty-six

COST ESTIMATING

To adequately define the project scope and to insure sufficient construction funds are available, cost estimates are required during the various stages of project development. As the project progresses, the estimates are refined to insure the project is still cost effective, sufficient funds are available for construction and the contractor's bid price is reasonable. This Chapter discusses the various project estimates that are required and who is responsible for their preparation.

36.1 PROGRAMMING ESTIMATES

Preliminary cost estimates, along with other priorities, will determine which projects will be included in the Transportation Improvement Plan/State Transportation Improvement Plan (TIP/STIP).

36.1.1 TIP/STIP Inclusion

Using the information gathered during the scoping review, the initial project cost estimate will be developed by the Value Engineering and Cost Estimating Group in the Program Development Section. The estimate will generally be developed by using recent comparable contract bids for different areas of the State. The Preliminary Engineering Group, Right of Way Office, Bridge Design Section, Survey/Utilities Office, Traffic Engineering Division, Environmental Management Office, Hydraulic Engineering Section and other Sections, as needed, will provide their costs as necessary. The estimated cost of any outstanding features identified during the scoping review will also be included at this time. These costs should be prepared prior to inclusion of a project in the TIP/STIP. Trends will be established to determine cost factors for inflation to arrive at future costs for inclusion in the TIP/STIP. These initial costs, including back-up data, will be provided to the Metropolitan Planning Organizations/Council of Governments (MPO/COG) as appropriate. The involvement and detail of the above may vary dependent upon the Program Manager's participation in estimates shown in the TIP/STIP and/or the time lapsed between estimates provided for the TIP/STIP and PAR submittal.

36.1.2 Post Public Hearing

The preliminary engineering, right of way and construction cost estimates will be updated within 60 days after the design public hearing. This will include the following:

1. The Program Manager will request the Right of Way Office to provide a written estimate for the proposed right of way. The request should include a copy of the Plans delineating the impacts.
2. The Value Engineering and Cost Estimating Group will calculate the preliminary quantities and apply the appropriate unit costs to these quantities. This cost estimate will be more detailed and, consequently, a more accurate cost estimate than the initial TIP/STIP cost estimate.
3. Actual preliminary engineering expenditures will be compared against the original allotments to determine if cost allotments need to be increased.
4. The Program Manager will submit the updated cost estimate to the appropriate SCDOT and FHWA Offices as well as to the applicable MPO/COG.
5. The Program Manager will document any substantial changes in the cost estimates (e.g., 15 percent or more) with explanation of reasons for the changes. A coordination meeting may be required to discuss options for revising the scope of the project or other modifications to contain the cost estimate within the original estimate. If it is determined to be appropriate to proceed with the project based on the updated cost estimates, then the Director of Preconstruction will send a copy of the documentation to the Director of Planning. The Planning Division will adjust the entries in the TIP/STIP. A PAR will be prepared to initiate adjustments in the PPMS as appropriate.

36.1.3 Right of Way Plans

Once the Right of Way Plans are completed, both the right of way and construction estimates will be updated by the Right of Way Office and the Value Engineering and Cost Estimating Group with input from other Sections, as necessary. A review of the preliminary engineering expenditures versus allotments will also be performed. The same procedures as noted in [Section 36.1.2](#) will be followed to notify all parties of the updated costs.

36.1.4 Construction Plans

These plans will reflect final quantities for which unit costs can be applied and a very detailed construction estimate can be performed by the Specifications and Cost Estimating Group. These plans would also reflect any changes that may have occurred during the right of way acquisition process. The procedures as noted in [Section 36.1.2](#) will be followed to notify all parties of the updated costs.

36.1.5 Procedures for Developing Cost Estimates

The following procedures will apply:

1. Preliminary Engineering. Preliminary engineering costs are generally calculated between 10 and 15 percent of the construction estimate. This percentage may be adjusted upwards for projects that require a considerable effort for the amount of construction involved (e.g., intersection improvement projects), or could be less for projects that do not require as much time and effort for studies and plan preparation (e.g., resurfacing projects).
2. Utilities. The Utility Office will provide the utilities relocation cost estimate.
3. Right of Way. The Right of Way Office will provide all right of way costs. Because roadway designs will not initially be available, right of way costs will be estimated using a suggested right of way width with estimated acreage and using relocations denoted during the scoping review. The estimates should include an appropriate percentage increase to cover personnel services and equipment, appraisals, condemnation settlements and other miscellaneous costs that are difficult to anticipate during the initial stages of project development. Cost factors for inflation will be applied to arrive at future year costs in the STIP.
4. Construction Costs. After the construction cost estimate has been determined, 10 percent to 15 percent will be added for engineering and contingencies costs and 5 percent will be added to the construction cost estimate for cost overruns. Cost factors for inflation will be applied to arrive at future year costs in the STIP.
5. Estimate Updates. At a minimum, every two years the cost estimate will be updated.
6. Project Scope Changes. If a project's scope changes or if a project's cost significantly increases at any point during the planning or design process, the Program Manager will notify the Program Development Engineer who will review the issues with the Director of Preconstruction as necessary.

36.2 ENGINEER'S ESTIMATE

The Engineer's Estimate provides the Department with a basis for evaluating the bids for highway construction and allows the Department to determine if the low bid price is fair and reasonable for the work involved. This estimate, plus the data used to generate the estimate, is considered confidential and is not for general distribution. Section 36.2 discusses the procedures for developing the actual cost estimate.

36.2.1 Responsibilities

36.2.1.1 Design Units

The following discusses the responsibilities of the various units for the Engineer's Estimate:

1. Road Design Group. The Road Design Groups are responsible for providing the Specifications and Estimates Group with a complete set of quantities and Plans for the project. The Road Design Group is responsible for entering all quantities into the Department's estimating software package (i.e., Trns•port's Proposal and Estimates System (PES) and Letting and Award System (LAS)). The designer should provide the Specifications and Estimates Group with any information that may influence the cost of the project (e.g., special commitments, experimental materials, special equipment, expected construction delays). Other Sections and Divisions will prepare their own cost estimates (e.g., Bridge, Traffic). The designer is responsible for insuring that these Units receive the correct information so that they can properly prepare their estimates.
2. Utilities Office. The Utilities Office will provide the Specifications and Estimates Group with completed cost and specifications for any work to be included in the highway contract.
3. Bridge Design Section. The Bridge Design Section will provide the Specifications and Estimates Group with a complete cost estimate for all structural elements designed by the Section for direct incorporation into the Engineer's Estimate.
4. Traffic Engineering Division. The various Sections within the Traffic Engineering Division (e.g., Signing, Traffic Signals, Highway Lighting, Pavement Markings) are responsible for supplying the Specifications and Estimates Group with a complete cost estimate for their applicable design work for direct incorporation into the Engineer's Estimate.
5. Changes. If an estimated quantity, pay item and/or unit price is changed, the applicable designer should immediately notify the Specifications and Estimates

Group of the change. The Specifications and Estimates Group will revise the estimate accordingly.

36.2.1.2 Specifications and Estimates Group

After receiving the information from the various design groups, the Specifications and Estimates Group is responsible for conducting the following:

1. Roadway Elements. The Road Design Group will be responsible for inserting the quantities into the Department's estimating software package (i.e., Trns•port). The Design Services Group will review the quantities and check them for errors and/or omissions. If significant discrepancies are noted, they will contact the Road Design Group to discuss and resolve any differences.
2. Other Design Elements. The Specifications and Estimates Group will review and compile the estimates from the Bridge Design Section, Traffic Engineering Division and other Units as necessary.
3. Trns•port. The Specifications and Estimates Group will enter the cost estimate into Trns•port making it available to the Federal-Aid Office of Preconstruction Management and to the Director of Construction Office.

36.2.2 Estimating Procedures

The Department uses two modules from the AASHTO Trns•port software program to track cost estimates. These programs are described below:

1. Trns•port. Trns•port is AASHTO's information system for managing transportation programs, beginning with planning and estimation and carrying through the development of bidding documents, letting and contract award and management of construction operations. Trns•port also provides a database of historical capabilities and ad hoc reporting.
2. PES. Trns•port Proposal and Estimates System (PES) is an interactive, online system for managing project information during the pre-letting phase of a construction project. PES permits the flexible definition of a project and its associated funding requirements to track and manage project cost information and set up the bidding proposal prior to the bid letting activity.

With PES, data can be entered at the project, category and item level, and grouping of multiple projects is allowed to track all related costs and funding sources. PES supports preparation of the PS&E estimate for Federal-aid highway construction projects, allows projects to be combined into proposals for

bid letting and permits the selection of a group of proposals for a bid letting package.

3. LAS. The Transport Letting and Award System (LAS) provides the capabilities to automate the many tasks that are necessary during the letting and award stages of a transportation construction project. LAS aids in advertising bids, tracking plan and proposal holders, processing bid information, evaluating bids and making award decisions. It provides online and batch data entry with full edit checking and verification for vendor bids, produces the bid tabulation report and performs analyses on received bids. LAS also maintains the Planholder's List, produces mailing lists and maintains information for invoicing vendors for proposals and plans purchased.

36.2.3 Estimating Guidelines

The estimator will consider the following:

1. Unit Costs. Based on the proposed scope for the project, the estimator may revise unit prices based on the following factors:
 - geographic location (e.g., urban/rural, engineering district);
 - similarity of recent construction projects;
 - inflation (adjustments of past prices to reflect the current year);
 - reliability of recent construction cost data;
 - recent trends in cost of materials, labor and equipment;
 - anticipated difficulty of construction;
 - project size relative to size of similar projects;
 - proposed project schedule;
 - anticipated construction staging;
 - expected environmental problems (e.g., hazardous wastes, wetlands);
 - use of experimental materials; and
 - engineering judgment.
2. Lump-Sum Items. Desirably, lump-sum items should not be used on a project. However, this is not always practical. In determining the unit price for lump-sum items, the estimator should consider the following:
 - a. Components. Most lump-sum items can be divided into individual parts for estimating purposes. Once the elements have been segregated, the estimator should use engineering judgment to determine the appropriate cost for each component.

- b. Percentages. Some lump-sum items are determined based on a percentage of the total of the contract items or by the length of the project (e.g., mobilization, clearing right of way).
3. Miscellaneous Items. The following pay items are generally included in the cost estimate:
 - a. Clearing and Grubbing. Clearing and grubbing will be included on most projects. It is typically determined by using the various components of clearing and grubbing.
 - b. Traffic Control. Maintaining traffic is a lump-sum item and will be determined based on its various components. Elements that should be considered include traffic volumes, traffic composition, peak times, number of lanes, length of construction and type of work. Traffic control is generally not required for rural, local road projects.
 - c. Mobilization. In general, mobilization is determined by using an internal Department formula. Mobilization costs consist of preparatory work and operations necessary for the movement of personnel, equipment, supplies and incidentals to and off the project site; for the establishment and removal of offices, buildings and other facilities necessary for work on the project; and for all other work or operations that must be performed or costs incurred when beginning or ending work on the project.
 4. Incidental. Incidental costs cover any items that may or may not be addressed by a specific contract pay item. Incidental costs may include:
 - work included in other items by specification or special provision;
 - coordination with other contractors;
 - accelerated completion dates;
 - night work;
 - congested work areas;
 - hauling through heavy traffic, frequent railroad crossings or traffic signals;
 - the season during which the work will be performed;
 - special requests provided by outside agencies (e.g., OSHA, EPA);
 - utilities; and
 - liquidated damages.

Table of Contents

<u>Section</u>	<u>Page</u>
37.1 COMPLETE AND SIGN FINAL CONSTRUCTION PLANS	37.1(1)
37.2 BID PROPOSAL PREPARATION	37.2(1)
37.2.1 Operations Center	37.2(1)
37.2.2 Specifications and Estimates Group	37.2(1)
37.3 CONSTRUCTION BIDS	37.3(1)

Chapter Thirty-seven

BID DOCUMENT PROCESSING

This Chapter discusses the responsibilities and activities of various Units in processing the plans, specifications and estimates (PS&E) package for letting. These PS&E Plans, specifications and cost estimates are then made available to various Units to prepare for letting.

37.1 COMPLETE AND SIGN FINAL CONSTRUCTION PLANS

The following defines the process for completing and having the Final Construction Plans signed:

1. Quantities. The Program Manager is responsible for insuring the applicable Sections (e.g., Traffic, Right of Way) have provided the road designer with any additional quantities to be incorporated into the Plans. The road designer is responsible for entering all quantities into the Department's software package (i.e., Trns•port's Proposal and Estimates System (PES) and Letting and Award System (LAS)); see [Section 36.2.2](#).
2. Initial Acceptance. The Design Group Coordinator will submit the Plans to their Facilitator for review. Once the Facilitator is satisfied with the Final Construction Plans, the Coordinator will submit the Final Construction Plans, the Design Field Review Plans and comments and all quantity computations to the Design Services Group. This should occur prior to the scheduled letting date, in accordance with the published schedule (Dates for Assembling Information on Construction Obligations).
3. Plan Review. The Design Services Group will conduct a quality control review of the Plans. The Design Services Group will check the Plans for completeness to meet the following:
 - the approved project scope of work and Project Planning Report;
 - the design criteria presented in the *SCDOT Highway Design Manual*, except where revised by a design exception;
 - the criteria presented in the Instructional Bulletins and Engineering Directive Memorandums;
 - any reports or studies for the project;

- the plan preparation guidelines presented in [Chapter 34](#) and the *Road Design Plan Preparation Guide*;
- to insure the designer has addressed all project commitments; and
- to insure the designer has addressed all issues from the Design Field Review.

The Plans will be returned to the designer for corrections or clarifications. Upon completion of reviewing the corrections, the Design Services Group will submit the Plans to the Hydraulic Engineering Section for review and signature.

Secondary “C” funded projects will be submitted directly to the Road Design Engineer for signing and sealing. The Operations Center will forward these plans to the “C” Project Manager.

4. Hydraulic Engineering Review. The Hydraulic Engineering Section will review the Final Construction Plans to insure the designer has correctly incorporated the design information from the Hydraulic Report. Upon the completion of the Hydraulic Engineering Section’s review, the Hydraulic Design Engineer will sign the Plans and forward them to the Program Manager.
5. Program Management Review. The Program Manager will review and sign the Plans. The Program Manager will then forward the Final Construction Plans to the appropriate Program Development Engineer for signing and sealing. The Program Development Engineer will forward the Plans to the Operations Center in the Road Design Section. The Plans are then available for the Road Design Engineer to sign, seal and return to the Operations Center.

For “C” funded projects, the Project Manager will review and sign the Plans. At this time, the Project Manager will determine if a Hydraulic Engineering Design review is necessary. Once the Project Manager has determined that all necessary reviews are complete, the Plans are forwarded to the “C” Program Engineer for signing and sealing who in return forwards the Plans to the Operations Center.

During the review, the Project/Program Manager will verify that:

- all agreements with utility companies, railroad companies, local municipalities, etc., are completed prior to letting;
- all applicable permits have been approved before letting; and
- any right of way acquisitions, easements, agreements, etc., are completed prior to letting.

6. Revisions. Resubmit any changes to the Design Services Group Review for verification.

37.2 BID PROPOSAL PREPARATION

The Operations Center and the Specifications and Estimates Group are responsible for preparing the Bid Proposal. The Bid Proposal document will include:

- Notice to Contractors,
- Instructions to bidders (Federal Projects),
- Project Special Provisions,
- Supplemental Specifications,
- required Contract Provisions for Federal-aid construction projects (Federal Projects),
- standard Federal Equal Employment construction contract specifications (Federal Projects),
- wage regulations (Federal Projects),
- bid bond,
- proposal form, and
- DBE Committal Sheet (Federal Projects).

The following Sections define each Unit's responsibilities.

37.2.1 Operations Center

The Operations Center will:

1. Insure that all applicable Units have reviewed and signed the Road Plans and that all necessary submittals have been made to the FHWA.
2. Calculate the cost of Plans. Enter the cost information into the Department's software package, and merge projects (e.g., Bridge Plans, Landscaping Plans) into contracts for the letting.
3. Forward the Final Construction Plans to the Specifications and Estimates Group; see [Section 37.2.2](#).

37.2.2 Specifications and Estimates Group

The Specifications and Estimates Group will:

1. Prepare the Engineer's Estimate; see [Section 36.2](#).
2. Calculate the contract completion date.

3. Calculate the Disadvantaged Business Enterprise (DBE) goal for Federal-aid projects.
4. Solicit On the Job Trainees (OTJ) requirements from the Office of Compliance.
5. Prepare the proposal by:
 - a. Incorporating all required Special Provisions.
 - b. Insuring that all pay items are covered by the *Standard Specifications*, Supplemental Specifications or by the Special Provisions.
 - c. Preparing project specific Special Provisions noted during the Plan preparation and review.
6. Submit to the Operations Center the "List of Items" from the proposal. The Operations Center will forward the "List of Items" and the Plans to the Design Services Group to insure the quantities, pay item numbers and pay items on the Plan's Summary of Estimated Quantities Sheet and the proposal agree.

After the proposal has been completed and all necessary signatures have been obtained, the Operations Center and Specifications and Estimates Group forward the Final Construction Plans and proposals to the Engineering Reproduction Services for printing. After the printing has been completed, the bid documents are then forwarded to the Engineering Publications Customer Service Center within the Construction Division in accordance with the published schedule.

37.3 CONSTRUCTION BIDS

The Contracts Administration Office is responsible for the following:

1. Advertising. The Contracts Administration Office will prepare and publish an ad for the highway letting. This ad is placed on the Department's website approximately 5 weeks prior to letting. Authorization to bid is issued to prequalified contractors who have work ratings that indicate their ability to complete the work. The Contracts Administration Office determines this prequalification list. For large and/or multi-phased projects, it may be determined necessary to conduct a pre-bid meeting. The Program Manager and/or the designer may be asked to attend this meeting.
2. Conducting Bid Opening. At the opening hour of 11:00 am, the Contracts Administration Office will receive the Contractor's electronic bid. After the specified time, no additional bids will be accepted. The amount of each bid, including alternatives and combinations, if any, are recorded and read publicly.
3. Reviewing the Bids. The Contracts Administration Office will incorporate the bid information into the Trns•port System and check the bid for accuracy to insure the Contractor has correctly submitted the bid. If the bids have been properly submitted, the Contracts Administration Office will forward the lowest bid to the Program Manager for review. The Program Manager will resolve any substantial differences between the Contractor's bid and the STIP amounts. The Contracts Administration Office will coordinate the award with FHWA on all oversight projects.
4. Awarding the Project. If the low bid is determined to be acceptable, the Contractor and Program Manager are notified of the approval. Once the contract has been approved and signed, the project responsibilities are then transferred to the Resident Construction Engineer. The Utilities Office will distribute Utility and/or Railroad Agreements to the appropriate Company.

Once the contract has been accepted and signed, the Contractor can begin construction on the project. At this project stage, the designer may be requested to clarify the construction plans, offer guidance, review shop drawings, etc.

GLOSSARY

AASHTO. American Association of State Highway and Transportation Officials.

Acceleration Lane. The portion of the roadway adjoining the main traveled way consisting of tapers, widened areas, or auxiliary lanes which function as speed change lanes, turning lanes or segments of traffic interchange directions.

Accessible Route. A continuous, unobstructed path connecting all accessible elements and spaces in a building, site or facility. A "site" is defined as a parcel of land bounded by a property line or a designated portion of a public right-of-way. A "facility" is defined as all or any portion of buildings, structures, site improvements, complexes, equipment, roads, walks, passageways, parking lots, or other real or personal property on a site.

Action. For purposes of 23 CFR 771, this is a highway project proposed for FHWA funding. It also includes activities (e.g., joint and multiple-use permits, changes in access control) that may or may not involve a commitment of Federal funds.

Allowable Headwater Depth. The depth or elevation of the flow impoundment for a drainage facility (e.g., a culvert) above which damage or a significant flood hazard could occur.

Americans with Disability Act (ADA). A Federal regulation requiring the implementation of accessibility design criteria for highway elements that affect the accessibility and mobility of disabled individuals. These include sidewalks, parking lots and buildings at transportation facilities, overpasses and underpasses.

Arterials. Functionally classified highway that is characterized by a high degree of continuity and a capacity to quickly move relatively large volumes of traffic but often provide limited access to abutting properties. The arterial system typically provides for high travel speeds and the longest trip movements.

Auxiliary Lane. The portion of the roadway adjoining the through traveled way for purposes supplementary to through traffic movement including parking, speed change, turning, storage for turning, weaving or truck climbing.

Average Annual Daily Traffic (AADT). The total volume of traffic passing a point or segment of a highway facility, in both directions, for one year, divided by the number of days in the year.

Average Daily Traffic (ADT). A general unit of measure for traffic expressed as the total volume during a given time period, greater than one day and less than one year, divided by the number of days in that time period.

Back Lip. The portion of a valley gutter section beyond the gutter.

Backslope. The side slope created by connecting the ditch bottom or shelf, upward and outward, to the natural ground line.

Backwater. The increase in water surface elevation relative to the elevation occurring under natural channel and floodplain conditions upstream of a highway facility.

Barrier Terminals. End treatments for roadside barriers, median barriers and transitions to other types of barriers (e.g., to bridge rails).

Base Flood. The flood having a 1 percent chance of being exceeded in any given year.

Benchmark. A vertical point of reference in topographic surveys from where measurements are made.

Berm. A narrow shelf or ledge typically at the top or bottom of a roadway foreslope or backslope. It is typically designed with a mound of landscaped earth.

Berm Ditch. A drainage channel used to intercept and remove surface runoff placed at the top of cut sections and adjacent to berms at the bottom of fill slopes.

Beveled. A tapering treatment required of the end sections of corrugated metal pipe and reinforced concrete pipe culverts.

Bi-directional Barrier. A barrier designed to safely handle an impact from either direction.

Bicycle Lane. A portion of a roadway, which has been designated by striping, signing and pavement markings for the exclusive use of bicyclists.

Bicycle Path. A bikeway physically separated from motorized vehicular traffic by an open space or barrier.

Bikeway. Any road, path or way which in some manner is specifically designated as being open to bicycle travel, regardless of whether such facilities are designated for the exclusive use of bicycles or will be shared with other transportation modes.

Borrow. Twenty-six cubic yards or more of additional excavation required from a source outside the project limits for construction of the facility.

Bridge. A structure, including supports, erected over a depression or obstruction, such as water, a highway, or a railway, and having a track or passageway for carrying traffic or other moving loads, and having an opening measured along the center of the roadway of more than 20 feet between undercopings of abutments or spring lines or arches or extreme ends of openings for multiple boxes; may include multiple pipes where the clear distance between openings is less than half of the smaller contiguous opening.

Broken-Back Curves. Closely spaced horizontal curves with deflection angles in the same direction with an intervening, short tangent section (less than 1500 feet).

Buffer. The area or strip between the roadway and a sidewalk.

CADD. Computer-aided drafting and design.

“C” Project. A minor road project included in the highway program established by the South Carolina Legislature to provide efficient transportation for the State’s residents funded entirely with State monies.

Capacity. The maximum hourly rate at which persons or vehicles can reasonably be expected to traverse a point or uniform section of a lane or roadway during a given time period under prevailing roadway, traffic and control conditions. Capacity is usually expressed as vehicles per hour or persons per hour.

Categorical Exclusion (CE). A category of actions that do not individually or cumulatively have a significant effect on the human environment for which, therefore, neither an Environmental Assessment nor an Environmental Impact Statement is required.

Channel Change. A modification to the natural alignment of a channel (stream) necessitated by highway construction.

Channelization. The use of pavement markings (e.g., striping, raised reflectors) curbs or islands to direct traffic through an intersection.

Clearance. The removal of material, vegetation or other structures from a defined area; the vertical or horizontal clear distance between specified highway elements.

Clear Zone. The roadside border area beginning at the edge of the traveled way that is available for safe use by errant vehicles.

Climbing Lane. An auxiliary lane provided on the right side of the through lane on positive grades to minimize interference between vehicles traveling at normal running speeds and vehicles traveling at slower speeds.

Coded Pay Items. An item of work specifically described and for which a price, either unit or lump sum, is provided. Each pay item has an official title and code number that is tied to the *Standard Specifications*.

Collector/Distributor (CD). A roadway provided to eliminate weaving and reduce the number of ingress and egress points along the through roadways while satisfying the demand for access to and from the freeway.

Collectors. Functionally classified highway that is characterized by a roughly even distribution of their access and mobility functions.

Comfort Criteria. Design criteria that are based on the comfort effect of the change in vertical direction in a sag vertical curve due to the combined gravitational and centrifugal forces.

Compound Curves. A series of two or more simple curves with deflections in the same direction that are immediately adjacent to each other.

Concrete Median Barrier (CMB). A rigid barrier constructed in a median that can accommodate most vehicular impacts without penetration.

Condemned Parcels. The act of acquiring property by following the prescribed legal process as set forth in the *Eminent Domain Act* of April, 1988.

Construction and Resource Management (CRM). A Department program that provides public-private partnership aimed at completing 27 years worth of road and bridge work in 7 years as part of SCDOT's accelerated construction program.

Controlled by Regulation. Access that is managed through the granting of revocable permits to private parties to construct and maintain an approach or driveway.

Controlling Criteria. A list of geometric criteria requiring approval if they are not met or exceeded.

Control of Access. The regulated limitation of public access rights to and from properties abutting a highway facility.

Corner Island. A raised or painted island to channel the right-turn movement.

Council of Environmental Quality (CEQ). The CEQ is composed of three members appointed by the President; it maintains a quality awareness of the nation's environmental resources. The CEQ oversees the implementation of the *National Environmental Policy Act* (NEPA) by issuing regulations (40 CFR Parts 1500-1508) to guide all Federal agencies.

Crashworthy. A feature that has been proven acceptable for use under specified conditions either through crash testing or in-service performance.

Crest. The highest point on a vertical curve or the high point in rolling terrain.

Criteria. A term typically used to apply to design values, usually with no suggestion on the criticality of the design value. Because of its basically neutral implication, this *Manual* frequently uses "criteria" to refer to the design values presented.

Critical Length of Grade. The maximum length of a specific upgrade on which a loaded truck can operate without an unreasonable reduction in speed.

Critical Parallel Slope. Fill sections with slopes steeper than 3H:1V that cannot be safely traversed by a run-off-the-road vehicle.

Cross Section. A graphical representation of a transverse section of the roadway showing existing ground, roadway template, right of way line and all structures normally plotted at 50-foot intervals on curves and 100-foot intervals (i.e., tangent sections) plotted to scale.

Cross Slope. The slope in the cross section view of the travel lanes, expressed as a percent or ratio based on the change in horizontal compared to the change in vertical.

Crown. The highest point in the roadway cross section. The inside high point of a drainage structure. Generally, referenced at the inlet and outlet ends.

Culvert. A structure that is usually a closed conduit designed hydraulically to take advantage of submergence to increase hydraulic capacity and convey surface runoff through a highway or railroad embankment. AASHTO classifies a culvert as a structure of less than 20-foot span as measured along the roadway centerline. A culvert is a structure, as distinguished from a bridge, that is usually covered with embankment and is composed of structural material around the entire perimeter.

Curb. A raised or vertical element to provide drainage control, pavement edge delineation, right of way reduction, aesthetics, delineation of pedestrian walkways, reduction of maintenance operations and assistance in orderly roadside development.

Curb and Gutter. A curb element combined with a gutter section to provide an improved longitudinal drainage system.

Curb Return. The circular segment of curb at an intersection that connects the tangent portions of the intersecting legs.

Cut Section. A cross section of the roadway where the centerline is at a lower elevation than the original ground line.

Deceleration Lane. The portion of the roadway adjoining the main traveled way consisting of tapers, widened areas, or auxiliary lanes which function as speed change lanes, turning lanes or segments of traffic interchange directions.

Decision Sight Distance. The sight distance required by drivers to make informed decisions where the highway environment is difficult to perceive or where unexpected maneuvers are required.

Dedicated Right of Way. Property conveyed to a public-governmental entity, by a private source, for public use and benefit. For the dedicated property to be valid, a public body must accept the property.

Department (SCDOT). South Carolina Department of Transportation.

Depressed Median. A median that is lower in elevation than the traveled way and designed to carry a certain portion of the roadway runoff.

Design Flood Frequency. The flood frequency selected for determining the necessary size of the drainage appurtenance.

Design Hourly Volume (DHV). The 30th highest hourly volume of the future year traffic assigned for the design, expressed in vehicles per hour.

Design Speed. The maximum safe speed that can be maintained over a specified section of highway.

Design Vehicle. The vehicle used to design turning radii, off-tracking characteristics, pavement designs, etc.

Design Year. The year for which design hourly volumes are derived to determine the design features required for the proposed improvements, usually 20 years from the date of construction completion.

Detention Pond. A basin, pond or reservoir incorporated into the watershed where runoff is temporarily stored, thus attenuating the peak of the runoff hydrograph. A stormwater management facility that temporarily impounds runoff and discharges it through a hydraulic outlet structure to a downstream conveyance structure.

Divided Highway. A roadway that has separate traveled ways, usually with a depressed or CMB median, for traffic in opposite directions.

Drainage Area. A specific area that is delineated as the watershed that is producing runoff from rainfall and other forms of precipitation (i.e., the contributing watershed).

Drainage End Treatment. A structure, commonly made of concrete or metal, that is attached to the end of a culvert for such purposes as retaining the embankment from spilling into the waterway, improving the appearance, providing anchorage, improving the discharge coefficient and/or limiting some scour at the outlet.

Earthwork. The work required to bring a roadway typical section to the specified sub-grade elevation in excavation (cut) or embankment (fill).

Easement. An interest in land owned by another party, which entitles the easement holder to a specific, limited use.

Edge of Traveled Way (ETW). The line between the portion of the roadway used for the movement of vehicles and the shoulder regardless of the direction of travel.

Eminent Domain. The right of a government to obtain private property for public use by virtue of the superior dominion of the government over all lands within its jurisdiction.

Encroachment. Items placed within the existing right of way by persons other than the Department's staff or authorized agents.

Environmental Assessment (EA). A concise public document, for which a Federal agency is responsible, that serves to briefly provide sufficient evidence and analyses for determining whether to prepare an Environmental Impact Statement or a Finding of No Significant Impact.

Environmental Impact Statement (EIS). A detailed written statement, prepared for major Federal actions significantly affecting the quality of the human environment, which discusses the environmental impact of the proposed action; any adverse environmental effects which cannot be avoided should the proposal be implemented; alternatives to the proposed action; the relationship between local short-term uses of man's environment and the maintenance and enhancement of long-term productivity; and any irreversible and irretrievable commitments of resources that would be involved in the proposed action should it be implemented.

Erosion Control. The mitigation measures used to reduce (or decelerate) erosion, which is a natural or geologic process whereby soil materials are detached and transported from one location and deposited elsewhere, primarily due to rainfall, runoff and wind.

FHWA. Federal Highway Administration.

Fill Slopes. Slopes extending outward and downward from the shoulder hinge point to intersect the natural ground line.

Finding of No Significant Impact (FONSI). A document by a Federal agency briefly presenting the reasons why an action, not otherwise excluded, will not have a significant impact on the human environment and for which an Environmental Impact Statement therefore will not be prepared.

Flood Frequency. The number of times a flood of a given magnitude can be expected to occur on average over a long period of time.

Floodplain. Any plain that borders a stream and is covered by its waters in time of flood. An almost flat, alluvial lowland bordering a stream, commonly formed by stream processes, that is subject to inundation by floods.

Flush Median. A paved median that is essentially level with the surface of the adjacent traveled way.

Fly-over. A grade separation structure used to accommodate a major left-turning movement.

Foreslope. This is the side slope in a cut section created by connecting the shoulder to the ditch hinge point, downward and outward.

Freeway. The highest level of arterial. This facility is characterized by full control of access, high design speeds and a high level of driver comfort and safety.

Frontage Road. A roadway used to control access to an arterial, function as an access facility to adjoining property and to maintain circulation of traffic on each side of the arterial.

Full Control (Access Controlled). Access is allowed only at specified interchanges or at specified public approaches. It is intended to give high priority to the uninterrupted movement of through traffic. At-grade access is inconsistent with full access control.

Gating. A term used to describe barrier end treatments that are designed to allow controlled penetration by an impacting vehicle.

Gore Area. The paved triangular area between the through lane and the exit ramp, plus the graded area that may extend a few hundred feet downstream beyond the gore nose.

Grade Separation. A crossing of two highways or a highway and a railroad at different levels.

Grade. The rate of slope expressed as a percent between two adjacent Vertical Points of Intersection (VPI). The numerical value for the grade is the vertical rise or fall in feet for each foot of horizontal distance. The numerical value is multiplied by 100 and is expressed as a percent. Upgrades in the direction of stationing are identified as positive (+). Downgrades are identified as negatives (-).

Guardrail. A barrier designed to redirect a vehicle.

Guidance. This category is considered to be advisory usage, recommended but not mandatory. Deviations are allowed where engineering judgment indicates that it is appropriate.

Guideline. Indicating a design value which establishes an approximate threshold which should be met if considered practical.

Gutter. The paved area adjacent to a curb or flume formed in asphalt pavement, used for longitudinal pavement drainage.

HCM. *Highway Capacity Manual*.

Heavy Vehicle. Any vehicle with more than four wheels touching the pavement during normal operation. Heavy vehicles collectively include trucks, recreational vehicles and buses.

High Speed. For geometric design purposes, high speed is defined as greater than 45 miles per hour.

Highway, Street or Road. A general term denoting a public way for purposes of vehicular travel, including the entire area within the right of way. (Recommended usage: in urban areas – highway or street, in rural areas - highway or road).

Highway Capacity. The existing and design year (normally 20 years from the end of the proposed construction) traffic volumes are used with the highway capacity calculations to determine the highway design based on the desired level of service.

Hinge Point. The point where the height of fill and depth of cut are determined. For fills, the point is located at the intersection of the shoulder and the fill slope. For cuts, the hinge point is located at the toe of the back slope.

Hydrology. The science that explores the interrelationship between water on the earth and in the atmosphere. In hydraulic practice for highways, hydrology is used to calculate discharges for a given site based on the site characteristics.

Impact Attenuator (Crash Cushion). A device that prevents an errant vehicle from impacting fixed objects by gradually decelerating the vehicle to a safe stop or by redirecting the vehicle away from the obstacle.

Intensity. The rate of rainfall upon a watershed, usually expressed in inches per hour.

Interchange. A system of ramps in conjunction with one or more grade separations, providing for the movement of traffic between two or more roadways on different levels.

Intersection. The general area where two or more highways join or cross, within which are included the roadway and roadside facilities for traffic movements in that area.

Intersection Sight Distance (ISD). The sight distance required within the corners of intersections to safely allow a variety of vehicular access or crossing maneuvers based on the type of traffic control at the intersection.

ITE. Institute of Transportation Engineers.

K-Values. The horizontal distance needed to produce a 1 percent change in gradient.

Land Locked Parcels. A parcel of land that has no legal access. A parcel of land may be land locked as it exists or may become land locked as a result of highway improvements.

Landing Area. The area approaching an intersection for stopping and storage of vehicles.

Level of Service (LOS). A set of criteria that describes the degree to which an intersection, roadway, weaving section or ramp can effectively serve peak-hour and/or daily traffic.

Limited Access Control. Access is allowed at specified public roads or at private driveways as specified in legal agreements and/or deeds. The established street system is given first priority in access to the highway. When it is determined that reasonable private access cannot be provided using the public access, direct private access may be allowed at specific points.

Local Roads and Streets. All public roads and streets classified below the collector level.

Longitudinal Barrier. A barrier whose primary function is to prevent penetration and to safely redirect an errant vehicle away from a roadside or median obstacle.

Low Speed. For geometric design purposes, low speed is defined as 45 miles per hour or less.

Major Intermodal Connectors. Selected streets and highways (primarily in urban areas) that provide access between another NHS designated route (Interstate or OPA) and a designated major port, airport, public transportation facility, freight facility or other intermodal transportation facility.

Major Strategic Highway Network (STRAHNET) Connectors. Roads and highways that provide access between major military installations and highways that are part of the Strategic Highway Network (Interstate system).

Maximum Side Friction (f_{max}). Limiting values selected by AASHTO for use in the design of horizontal curves. The designated f_{max} values represent a threshold of driver discomfort and not the point of impending skid.

Maximum Superelevation (e_{max}). An overall superelevation control used on a widespread basis. Its selection depends on several factors including type of area (rural or urban), design speed and climate.

Median Barrier. A longitudinal barrier used to prevent an errant vehicle from crossing the median of a divided highway thereby preventing head-on collisions between opposing traffic.

Median Slope. The slope in the cross section view of a median beyond the shoulder, expressed as a ratio of the change in horizontal to the change in vertical.

Mitigation. Alleviation of adverse environmental or construction impacts.

Momentum Grade. Sites where an upgrade is preceded by a downgrade. These locations allow a truck to increase its speed on the downgrade before ascending the upgrade.

Multilane Highways. Multilane highways have two or more lanes in each direction and may be one-way, two-way, divided or undivided.

Municipal Street System. The Municipal Street System includes existing streets and streets established in municipalities that are not a part of the State Highway System or County Highway System, together with roads outside their corporate limits over which they have jurisdiction.

MUTCD. *Manual of Uniform Traffic Control Devices.*

National Environmental Policy Act (NEPA). NEPA, as amended, is a Federal environmental statute that requires the consideration of environmental factors through a systematic, interdisciplinary approach before committing to a course of action, the procedures are set forth in CEQ regulations and 23 CFR Part 771.

National Highway System (NHS). A system of highways determined to have the greatest national importance to transportation, commerce and defense in the United States. It consists of the Interstate highway system, other principal arterials, the Strategic Highway Network and Major Strategic Highway Network connectors.

National Network (Trucks). A national network of highways that allow the passage of trucks of maximum dimensions and weight.

National Pollutant Discharge Elimination System (NPDES). Areas determined at risk for erosion due to the construction of a highway facility. It requires the construction and maintenance of erosion control items during construction. All NPDES areas to be maintained after completion of a project are to be secured by permanent right of way.

National Register of Historic Places. The National Register is a database of properties that are considered historic and otherwise preserved by Section 106 historic preservation regulations. The Secretary of the US Department of the Interior maintains and establishes the criteria by which properties are evaluated for the National Register of Historic Places.

No-Control Intersection. An intersection where none of the legs are controlled by a traffic control device.

Non-Recoverable Parallel Slope. Slopes which can be safely traversed but upon which an errant vehicle is unlikely to recover and will continue down to the bottom.

Non-Redirective. A descriptive term which indicates that the roadside safety device will not redirect an impacting vehicle but will, rather, "capture" the vehicle (e.g., sand barrels) or allow the vehicle to pass through (e.g., breakaway sign supports).

Normal Crown (NC). The typical cross section on a tangent section of roadway (i.e., no superelevation).

Offset. Related to displacement of a reference survey point; the horizontal distance between two other highway elements located at right angles (transverse) from the direction of travel.

Operating Speed. The highest overall speed at which a driver can travel on a given highway under favorable weather conditions and under prevailing traffic conditions without at anytime exceeding the safe speed as determined by the design speed on a section-by-section basis.

Operational System. A roadside barrier, end terminal or crash cushion that has performed satisfactorily in full-scale crash tests and has demonstrated satisfactory in-service performance.

Overpass. A grade separation where the subject highway passes over an intersecting highway or railroad.

Parallel Slopes. Fill and backslopes for which the toe runs approximately parallel to the roadway.

Passing Sight Distance. The sight distance required for a following vehicle to maneuver around, in the opposing traffic lane, a slower vehicle and to safely return back to the appropriate travel lane.

Peak Hour Factor (PHF). The hourly traffic volume during the maximum volume hour of the day divided by the peak 15 minute rate of flow within the peak hour: a measure of traffic demand function within the peak hour.

Peak Discharge (Peak Flow). The maximum rate of water flow passing a given point during or after a rainfall event or snow melt.

Physical Nose. This is the point where the ramp and mainline shoulders converge.

Point of Compound Curvature (PCC). The point on an alignment where two curves having the same direction of deflection and different radii meet.

Point of Curvature (PC). The point where the tangent alignment ends and the horizontal curve begins.

Point of Grade. The line at which the profile grade is measured on the pavement.

Point of Intersection (PI). The point of intersection between two tangents.

Point of Revolution. The line about which the pavement is revolved to superelevate the roadway. This line will maintain the normal highway profile throughout the curve.

Point of Tangency (PT). The point where the horizontal curvet ends and the tangent alignment curve begins.

Policy. Indicating SCDOT practice which the Department generally expects the designer to follow, unless otherwise justified.

Posted Speed. The maximum legal speed permitted along a given section of highway.

Profile Grade Line. A series of tangent lines connected by vertical curves. Typically, the grade line is located along the roadway centerline of undivided multilane facilities and two-lane, two-way highways.

Project Planning Report. The document prepared in the preliminary project design stage setting all basic design details, providing coordination and data input in a uniform comprehensive format which can be used by all other units in their evaluations.

Radius Return. The point along the mainline pavement edge where the curb return of an intersection meets the tangent portion.

Raised/Planted Median. A raised and/or planted median used to manage access and/or for aesthetic purposes.

Recoverable Parallel Slope. Slopes that can be safely traversed and upon which a motorist has a reasonable opportunity to regain control of the vehicle. Fill slopes 4H:1V and flatter are generally considered recoverable.

Recovery Area. The unobstructed, relatively flat area provided beyond the edge of the traveled way for the recovery of errant vehicles.

Redirective. A term that indicates that the roadside safety device is designed to redirect an impacting vehicle approximately parallel to the longitudinal axis of the device.

Reference Point. A horizontal control point used in establishing or to re-establish a survey line or a highway alignment.

Refuge Island. Corner or divisional islands that function to aid and protect pedestrians and bicyclists who cross a wide roadway.

Relative Longitudinal Gradient. For superelevation transition sections on two-lane facilities, the relative gradient between the centerline profile grade and edge of traveled way, or between adjacent lanes.

Remove Adverse Crown (RC). A superelevated roadway section that is sloped across the entire traveled way in the same direction and at a rate equal to the cross slope on the tangent section (typically, 2.08 percent).

Retention Pond. A basin, pond or reservoir where water is stored for regulating a flood. It does not have an uncontrolled outlet. The stored water is disposed by such means as infiltration, by injection (or dry) wells or by release to the downstream drainage system after the storm event. The release may be through a gate-controlled gravity system or by pumping.

Reverse Curves. Two simple curves with deflection angles that are in opposite directions that are joined by a relatively short tangent distance or that have no intervening tangent (i.e., the PT and PC are coincident).

Right of Way. The land secured and reserved by the Department for the construction and maintenance of a highway and its appurtenances.

Rigid Barrier. A longitudinal barrier that does not deflect upon impact. Concrete barrier and bridge parapets are rigid barriers.

Roadside Barrier. A longitudinal barrier, such as guardrail, concrete barrier, etc., used to shield roadside obstacles or non-traversable terrain features.

Roadside Hazards. A general term to describe roadside features that may be impacted by a run-off-the-road vehicle. Roadside hazards include both fixed objects and non-traversable roadside features.

Roadway. (General) The portion of a highway including shoulders, for vehicular use. A divided highway has two or more roadways. (Construction) The portion of a highway within limits of construction.

Roll Over. The maximum allowable algebraic difference between two pavement plane surfaces expressed in percentages.

Rotation. An expression indicating the rate at which a plane surface varies in cross slope generally expressed as an edge of pavement rotation rate about a fixed centerline.

Rural Areas. Those places outside the boundaries of urban areas.

Sag. The low point of a parabolic vertical curve subtended by negative and positive grades.

Section 4(f) Land. Land owned in a public-owned park, recreation area or wildlife refuge, or any historic or archaeological site listed or eligible for listing on the National Register of Historic Places

Section 6(f) Land. Recreational land purchased and/or developed with Land and Water Conservation Fund monies.

Semi-Rigid Barrier. A longitudinal barrier ranging from almost rigid to quite flexible. Guardrail is a semi-rigid barrier.

Shelf. On curbed facilities, the relatively flat area located between the back of the curb and the break for the fill or back slopes.

Shoulder Slope. The slope in the cross section view of the shoulders, expressed as a percent or ratio.

Shoulder. The portion of the roadway contiguous to the traveled way for the accommodation of stopped vehicles, for emergency use, and for lateral support of base and surface courses. On sections with curb and gutter, the shoulder extends to the gutter line.

Shrinkage. The inverse relationship between the volume of undisturbed earth prior to removal from its original position and its volume after being placed in another position and compacted.

Shy Distance. The distance from the edge of traveled way beyond which a roadside object will not be perceived as an obstacle by the typical driver, to the extent that the driver will change vehicular placement or speed.

Shy Line Offset. The distance from the edge of the traveled way, beyond which a roadside object will not be perceived as hazardous and result in a motorist's reducing speed or changing vehicle position on the roadway.

Side Friction (f). The interaction between the tire and the pavement surface to counterbalance, in combination with the superelevation, the centrifugal force or lateral acceleration of a vehicle traversing a horizontal curve.

Sideslope. A ratio used to express the steepness of a slope adjacent to the roadway. The ratio is expressed as horizontal to vertical (H:V).

Sidewalk. That portion of the highway section constructed for the use of pedestrians used in combination with curb and gutter.

Simple Curves. Continuous arcs of constant radius that achieve the necessary highway deflection without an entering or exiting transition.

Site. A parcel of land bounded by a property line or a designated portion of a public right of way.

Slope Offset. On curbed facilities with sidewalks, the distance between the back of the sidewalk and the break for the fill slope or backslope.

Sloping Curb (Mountable Curb). A longitudinal element placed at the roadway edge for delineation, to control drainage, to control access, etc. Sloping curbs have a height of 6 inches or less with a face no steeper than 1 horizontal (H) to 3 vertical (V).

Spread. The transverse encroachment of stormwater onto a street where flow has accumulated in and next to the roadway gutter. This water may represent an interruption to traffic flow, splash-related problems and a source of hydroplaning during rainstorms.

State Highway. Any public highway planned, laid out, altered, constructed, reconstructed, improved, repaired, maintained or abandoned by the South Carolina Department of Transportation.

State Highway System. A system of highways and streets that are maintained by the South Carolina Department of Transportation.

Stop-Controlled Intersection. An intersection where one or more legs are controlled by a stop sign.

Stopping Sight Distance. The available sight distance on a roadway that is sufficiently long to enable a vehicle traveling at or near the design speed to stop before reaching a stationary object in its path.

Strategic Highway Network (STRAHNET). A network of highways that are important to the United States' strategic defense policy and which provide defense access, continuity and emergency capabilities for defense purposes.

Superelevation (e). The amount of cross slope or "bank" provided on a horizontal curve to counterbalance, in combination with the side friction, the centrifugal force of a vehicle traversing the curve.

Superelevation Runoff (L). The distance needed to change the cross slope from the end of the tangent runout (adverse cross slope removed) to a section that is sloped at the design superelevation rate (e).

Superelevation Transition Length. The distance needed to transition the roadway from a normal crown section to the design superelevation rate. Superelevation transition length is the sum of the tangent runout (TR) and superelevation runoff (L) distances:

Surface Transportation Program (STP). A flexible funding program that provides Federal funds for highway projects that are not on the National Highway System

Swell. The inverse relationship between the volume of undisturbed material prior to removing from its original position and its volume once removed.

Tangent Runout (TR). The distance needed to change from a normal crown section to a point where the adverse cross slope of the outside lane or lanes is removed (i.e., the outside lane(s) is level).

Template. Guide used to form, check, or draft various highway design elements.

Toe of Slope. The intersection of the fill slope, foreslope or backslope with the natural ground line or ditch bottom.

Traffic Control Device. Pavement markings, delineation devices regulatory/warning/route guidance signing and traffic signals to provide a motorist guidance, navigation information and warning.

Transverse Slopes. Fill slopes for which the toe runs approximately perpendicular to the flow of traffic on the major roadway. Transverse slopes are typically formed by intersections between the mainline and driveways, median crossovers or side roads.

Traveled Way. The portion of the roadway for the movement of vehicles, exclusive of shoulders and auxiliary lanes.

TRB. Transportation Research Board.

Trench Drain. A drainage inlet that extends for a considerable length, but with a narrow transverse opening, used to intercept sheet flow before exiting onto a roadway or to collect gutter flow to reduce ponding depth and spread at grate inlets.

Truck. A heavy vehicle engaged primarily in the transport of goods and materials, or in the delivery of services other than public transportation. For geometric design and capacity analyses, trucks are defined as vehicles with six or more tires.

Turn Lane. An auxiliary lane adjoining the through traveled way for speed change, storage and turning.

Turning Roadway. A channelized roadway (created by an island) connecting two legs of an at-grade intersection. Interchange ramps are not considered turning roadways.

Turning Template. A graphic representation of a design vehicle's turning path depicting various angles of turns for use in determining acceptable turning radii designs.

Two-Way, Left-Turn Lane (TWLTL). A lane in the median area that extends continuously along a street or highway and is marked to provide a deceleration and storage area, out of the through traffic stream, for vehicles traveling in either direction to use in making left turns.

Typical Section. A graphical representation of the roadway's transverse section with dimensions showing the width, limits, and slopes of the various cross sectional elements.

Underpass. A grade separation where the subject highway passes under an intersecting highway or railroad.

Undivided Highway. A roadway that does not have a physical barrier (e.g., depressed median, CMB median) between opposing traffic lanes.

Uni-directional Barrier. A barrier designed to safely handle an impact from only one direction, from front to rear.

Urban Areas. Those places within boundaries set by the responsible State and local officials having a population of 5000 or more.

USDOT. United States Department of Transportation.

V-Ditch. A triangular drainage channel constructed so that the foreslope and backslope meet at a point.

Valley Gutter. A paved longitudinal element placed at the roadway edge to control drainage.

Value Engineering. A concept that encourages the design of cost effective projects and may include the substitution of alternative designs, materials and/or innovative construction methods.

Vertical Curb (Barrier Curb). A longitudinal element, typically concrete, placed at the roadway edge for delineation, to control drainage, to control access, etc. Vertical curbs may range in height between 6 inches to 12 inches with a face no steeper than 1 horizontal (H) to 6 vertical (V).

Vertical Point of Curvature (VPC). The point at which a tangent grade ends and the vertical curve begins.

Vertical Point of Intersection (VPI). The point where the extension of two tangent grades intersect.

Vertical Point of Tangency (VPT). The point at which the vertical curve ends and the tangent grade begins.

Warrant. The criteria by which the need for a safety treatment or improvement can be determined.

Weaving. The vehicular maneuvers where the pattern of traffic entering and leaving a highway segment at contiguous points of access results in vehicle paths crossing each other.

Wetlands. Areas inundated or saturated by surface or ground water at a frequency and duration sufficient to support, and that under normal circumstances do support, a prevalence of vegetation typically adapted for life in saturated soil conditions. Wetlands generally include swamps, marshes, bogs and similar areas.

Yield-Controlled Intersection. An intersection where one or more legs are controlled by a yield sign.

-A-**ACCELERATION LANES**

Interchanges	Section 16.4.2
Intersections.....	Section 15.5.5

ACCESS CONTROL	Section 9.8, Section 30.3.6
----------------------	-----------------------------

ACCESSIBLE ROUTE	Section 17.1.6
------------------------	----------------

ACCESSIBILITY FOR DISABLED	Section 17.1, Section 21.2.9.3, Section 31.2.6
----------------------------------	---

ACCESS MANAGEMENT	Section 9.8, Section 31.1.3
-------------------------	-----------------------------

AESTHETICS.....	Section 13.3.4
-----------------	----------------

ALIGNMENT

Freeways.....	Section 19.2.3
Horizontal Controls.....	Section 11.2.7, Section 12.2.2
Intersections.....	Section 15.2.6
Vertical Controls.....	Section 12.2.1, Section 12.2.2

ARTERIALS

Definition	Section 9.4.1, Section 21.1.1
Rural.....	Section 20.1.4, Section 20.2.4
Urban	Section 21.3

AUXILIARY LANES

Clear Zone	Section 14.3.2.8
Cross Slopes.....	Section 13.2.5
Interchanges	Section 16.3.6
Parking Lanes	Section 21.2.8
Passing Lanes.....	Section 20.1.3.5
Truck-Climbing Lanes	Section 12.4
Turn Lanes	Section 15.5
Widths	Section 13.2.5

-B-

BARRIERS, MEDIAN	Section 13.4.2.1, Section 14.7
------------------------	--------------------------------

BARRIERS, NOISE – see NOISE CONTROL**BARRIERS, ROADSIDE**

Horizontal Sight Distances	Section 11.4
Layout	Section 14.6
Quantities	Section 35.6.1
Types/Selection.....	Section 14.5
Warrants.....	Section 14.4

BID PROPOSAL PREPARATION	Section 37.2
BIDS – see CONSTRUCTION	
BIKEWAYS	Section 13.2.3
BRIDGES	
3R Projects.....	Section 23.4.4
Bridge Design Section.....	Section 1.3.1.2.7
Clearances	Section 13.5.1
Coordination.....	Section 4.2.2
Local Roads and Streets	Section 22.2.6
Programs.....	Section 7.1.4, Section 7.1.3.4
Project Development.....	Chapter 3
Quantities	Section 35.6.9
Railroads.....	Section 13.5.1
Right of Way.....	Section 30.3
Superelevation	Section 11.3.7
Underpasses	Section 13.5.2
BUILDINGS, ACCESSIBILITY	Section 17.1.3
BUS STOPS/TURNOUTS	
Design.....	Section 17.5.2
Disabled Accessibility.....	Section 17.1.4
Location	Section 17.5.1
-C-	
CADD	
CADD Support	Section 1.3.1.2.6, Section 4.2.8.2
Plans	Section 34.1.1, Section 35.1
<i>Road Design CADD Users Guide</i>	Section 31.1.6.1
<i>SCDOT Standard Drawings</i>	Section 31.1.6.2
CAPACITY	
3R	Section 23.4.2
Roadway	Section 9.6.1, Section 9.6.4
Intersections.....	Section 15.2.8
Interchanges	Section 16.3.5
Traffic Engineering	Section 28.2
C-FUND PROGRAM	Section 7.2.3, Section 22.1.2
CHANNELIZATION	Section 15.6
CLASSIFICATION, FUNCTIONAL	Section 9.4.1

CLEARANCES

Horizontal	Section 13.5.1.4, Section 14.3
Vertical	Section 12.5

CLEAR ZONES, ROADSIDE	Section 14.3, Section 23.4.9
-----------------------------	------------------------------

CLIMBING LANES, TRUCK	Section 12.4, Section 20.1.3.4
-----------------------------	--------------------------------

COLLECTOR-DISTRIBUTOR ROADWAYS	Section 16.3.8
--------------------------------------	----------------

COLLECTOR ROADS AND STREETS

Definition	Section 9.4.1, Section 21.1.2
Rural	Section 20.1.4
Urban	Section 22.3

COMPUTERIZED ROAD DESIGN

CADD	Section 34.1.1
GEOPAK	Section 34.1.1.3
MicroStation	Section 34.1.1.2
Quantities Summaries	Section 35.1

CONTRACTS ADMINISTRATION OFFICE	Section 1.3.2.1.4, Chapter 3, Section 37.3
---------------------------------------	---

CONSTRUCTION

Bids	Section 37.3
Coordination	Section 4.1.3
Cost Estimates	Section 36.1
Division	Section 1.3.2, Chapter 3, Section 4.1.3
Plans	Section 33.6, Section 34.2.6
<i>Standard Specifications for Highway Construction</i>	Section 31.1.4
Supplemental Specifications	Section 31.1.4
Work Zone Traffic Control	Section 28.4

CONSULTANTS

Construction and Resource Management Program	Section 2.6.1
General	Section 2.6.2

CONTEXT SENSITIVE DESIGN	Section 9.10
--------------------------------	--------------

CONTROL OF ACCESS	Section 9.8, Section 30.3.6
-------------------------	-----------------------------

CONTROLLING DESIGN CRITERIA – see DESIGN CRITERIA

COST ESTIMATES

Development	Chapter 3, Section 36.1, Section 36.2
Engineer's Estimate	Section 36.2

COUNTY ROAD SYSTEM	Section 7.3.2, Section 22.1.3.2
CRASH CUSHIONS— see IMPACT ATTENUATORS	
CROSS SECTIONS	
Plans	Section 33.2.8, Section 33.3.4, Section 34.2.18
Typical Sections	Section 13.2.1
CROSS SLOPES	
Disabled Accessibility	Section 17.1
Freeways.....	Section 19.3
Local Roads and Streets.....	Section 22.3
Rural Highways	Section 20.1.4, Section 20.2.4
Shoulders	Section 13.2.4,
Traveled Way	Section 13.2.3
Urban Streets.....	Section 21.3
CULVERTS	
Design.....	Section 29.2.1
Right of Way.....	Section 30.3.11
Safety Design.....	Section 14.4
CURB RAMPS	Section 17.1.10, Section 29.2.1.4
CURBS	
Clear Zones.....	Section 14.3.2.6
Curb Ramps.....	Section 17.1.10
Curbed Sections.....	Section 13.2.6.3
Design.....	Section 21.2.9
Disabled Accessibility.....	Section 21.2.9.3
Roadside Safety.....	Section 14.3, Section 14.4
CURVES	
Horizontal	Section 11.2
Intersections.....	Section 15.2.6
Superelevation	Section 11.3
Vertical	Section 12.5
CUT SLOPES — see SLOPES	
DECISION SIGHT DISTANCE.....	Section 10.3
DEPRESSED MEDIAN	Section 13.4.2.3
DESIGN CONSISTENCY.....	Section 9.11

DESIGN CRITERIA

3R	Section 23.4
Freeways.....	Section 19.2, Section 19.3
Interchanges	Chapter 16
Intersections.....	Chapter 15
Local Roads and Streets	Section 22.2.2, Section 22.3
Multilane Highways	Section 20.2.1, Section 20.2.4
Suburban/Urban Streets.....	Section 21.2.3, Section 21.3
Two-Lane Highways.....	Section 20.1.2, Section 20.1.4

DESIGN EXCEPTIONS

Procedures.....	Section 9.2.2
Criteria — see DESIGN CRITERIA	

DESIGN FIELD REVIEW	Chapter 3, Section 30.2, Section 33.2
---------------------------	--

DESIGN HOURLY VOLUME (DHV).....	Section 9.6.1, Section 9.6.3
---------------------------------	------------------------------

DESIGN SPEED

3R Projects.....	Section 23.4.1
Clear Zone	Section 14.3.2.1
Definition	Section 9.5
Freeways.....	Section 19.2.2
Interchange Ramps.....	Section 16.5.2

DESIGN VEHICLES.....	Section 9.7, Section 15.2.5
----------------------	-----------------------------

DESIGN YEAR.....	Section 9.6.2
------------------	---------------

DETECTABLE WARNING SURFACES.....	Section 17.1.11
----------------------------------	-----------------

DETOURS.....	Section 33.3.12
--------------	-----------------

DISABLED, ACCESSIBILITY.....	Section 17.1
------------------------------	--------------

DISTRICT OFFICES	Section 1.3.2.4, Section 4.1.4
------------------------	--------------------------------

DITCHES

Ditch Section	Section 13.3.1.4
Roadside Safety.....	Section 14.3.4, Section 14.4.7, Section 23.4.9, Section 30.3.9

DRAINAGE

Aggregate Underdrain	Section 35.6.4
Asphalt Gutters	Section 29.3.5
Box Culvert Extensions	Section 29.3.6
Bridge Ends.....	Section 29.3.7
Coordination.....	Section 4.2.5
Crossline Pipes	Section 29.3.4, Section 35.5.2

Culverts.....	Section 14.4, Section 29.2.1.1
Curb Ramps.....	Section 29.2.1.4
Design.....	Chapter 3, Section 29.2.2
Design Criteria	Section 29.3
Ditches	Section 14.4.6, Section 29.2.1.3
Erosion Control	Section 34.2.16, Section 35.5.4
Hydraulic Engineering Section	Section 1.3.1.2.4, Section 4.2.5, Section 29.2.1
Inlet Spacing	Section 29.3.2
NPDES.....	Section 29.2.3
Plans	Section 33.2.5, Section 33.3.1, Section 34.2.15
Quantities	Section 35.5, Section 35.6.4
Railroads.....	Section 6.2.2
<i>Requirements for Hydraulic Design Studies</i>	Section 31.1.1
Right of Way.....	Section 30.3
Riprap.....	Section 35.5.1
Roadside Safety.....	Section 14.4.6
Sideline Pipes	Section 29.3.3, Section 35.5.3
<i>Specification Support Manual for GEOPAK Drainage</i>	Section 31.1.1
Storm Drainage	Section 29.2.1.2
Superelevation	Section 11.3.8
Trench Drains.....	Section 29.3.8
Vertical Curves.....	Section 12.5.1, Section 12.5.2
DRIVER EXPECTANCY	Section 9.11
DRIVEWAYS.....	Section 35.6.3
-E-	
EARTHWORK COMPUTATIONS	Section 35.2
ENGINEERING MEMORANDUM	Section 2.3
ENGINEER'S ESTIMATE.....	Section 36.2.1
ENVIRONMENTAL	
Acronyms	Section 27.6
Classes of Action	Section 27.3
Coordination.....	Section 4.2.4
Environmental Assessment.....	Section 27.3
Environmental Impact Statement	Section 27.3
NEPA	Chapter 3, Section 27.3
Permits	Chapter 3, Section 4.2.4, Section 27.5
Plans	Section 33.3.2
Procedures.....	Chapter 3
Right of Way.....	Section 30.2
Special Environmental Analyses	Section 27.4

Surveys	Section 26.2.4
ENVIRONMENTAL MANAGEMENT OFFICE.....	Section 1.3.1.1.1, Section 4.2.4
EROSION CONTROL	
Plans	Section 34.2.16
Practices	Section 35.5.4
Quantities	Section 35.5.4
-F-	
FEDERAL AGENCIES	
Federal Aviation Administration.....	Section 4.3.1.4
Federal Highway Administration — see FEDERAL HIGHWAY ADMINISTRATION	
National Park Service.....	Section 4.3.1.5
United States Forest Service.....	Section 4.3.1.2
United States Postal Service.....	Section 4.3.1.3
FEDERAL-AID FUNDING	Section 7.1
FEDERAL HIGHWAY ADMINISTRATION	Section 2.1.4, Section 2.5.4.2, Section 4.3.1.1, Section 9.9
FEDERAL LANDS.....	Section 7.1.5, Section 7.3.4
FENCING	Section 35.6.5
FILL SLOPES — see SLOPES	
FINAL CONSTRUCTION PLANS.....	Chapter 3, Section 33.4, Section 33.5, Section 34.2, Section 37.1
FLUSH MEDIAN	Section 13.4.2.1
FREEWAYS	
Definition	Section 9.4.1
Design.....	Section 19.2, Section 19.3
Frontage Roads	Section 19.5.3
Lane Drops.....	Section 19.5.1
Pedestrian	Section 19.5.4
Weaving	Section 19.5.2
FRONTAGE ROADS.....	Section 19.5.3, Section 20.2.3
FUNCTIONAL CLASSIFICATION SYSTEM	
Arterials.....	Section 9.4.1, Section 19.5.3.3, Section 21.1.1
Collectors	Section 9.4.1, Section 21.1.2
Local Roads and Streets.....	Section 9.4.1, Section 22.1

-G-**GEOTECHNICAL**

Features	Section 13.3.3
Investigation	Chapter 3

GRADES

Critical Length of	Section 12.3.3
Design	Section 12.3
Freeways.....	Section 19.3
Local Roads and Streets.....	Section 22.3
Profile Grade Line	Section 12.2.3
Rural Highways	Section 20.1.4, Section 20.2.4
Urban Streets.....	Section 21.3

GRADE SEPARATIONS.....	Section 13.5.1.3, Section 16.1.4, Section 19.4.2
------------------------	---

GUARDRAIL — see BARRIERS, ROADSIDE

-H-

HAZARDOUS MATERIALS	Section 27.4
---------------------------	--------------

HIGHWAY CAPACITY — see CAPACITY

HIGHWAY SYSTEMS

Functional Classifications — see FUNCTIONAL CLASSIFICATIONS	
Funding	Section 7.1, Section 7.2
Jurisdictional	Section 7.3, Section 22.1.3

HORIZONTAL ALIGNMENT

3R Projects.....	Section 23.4.6
Clear Zone Adjustments.....	Section 14.3.2.5
Controls.....	Section 11.2.7
Curve Radius	Section 11.2.3, Section 11.3.1.3
Curve Types.....	Section 11.2.2
Definitions	Section 11.1
Freeway/Ramps Junctions	Section 16.4.1.5
Horizontal Sight Distance.....	Section 11.4
Intersections.....	Section 15.2.6
Railroad/Highway Grade Crossings	Section 15.8.4
Ramps.....	Section 16.5.5
Superelevation — see SUPERELEVATION	

HORIZONTAL CLEARANCE	Section 13.5.1.4
----------------------------	------------------

HORIZONTAL SIGHT DISTANCE	Section 11.4
---------------------------------	--------------

HUMAN RESOURCES	Section 1.6
HYDRAULICS ENGINEERING SECTION	
Coordination.....	Section 1.3.1.2.4, Section 4.2.5
Design — See DRAINAGE	
-I-	
IMPACT ATTENUATORS	Section 14.8
INTELLIGENT TRANSPORTATION SYSTEMS	Section 28.5
INTERCHANGES	
Auxiliary Lanes	Section 16.3.6
Design	Section 16.3
Change in Access	Section 16.1.3
Collector-Distributor Roadways	Section 16.3.8
Freeway/Ramp Junction.....	Section 16.4
Grading and Landscaping	Section 16.3.14
Plans	Section 33.2.10, Section 33.3.9
Ramp/Crossroad Intersection.....	Section 16.6
Ramp Design	Section 16.5
Ramp Metering.....	Section 16.3.13
Spacing	Section 16.3.1, Section 16.3.2
Types/Selection.....	Section 16.2
Warrants.....	Section 16.1.2
Weaving	Section 16.3.7
INTERSECTIONS	
3R Projects.....	Section 23.4.7
Alignment	Section 15.2.6
Capacity	Section 15.2.8
Channelization	Section 15.6
Design Vehicles	Section 15.2.5
Intersection Sight Distance.....	Section 10.4, Section 15.2.10
Median Openings	Section 15.7
Plans	Section 33.2.9, Section 33.3.8
Profile	Section 15.2.7
Railroad/Grade Crossings	Section 15.8
Ramp/Crossroad	Section 16.6
Signalized.....	Section 15.2.9
Spacing	Section 15.2.3
Turn Lanes	Section 15.5
Turning Radii.....	Section 15.3
Turning Roadways	Section 15.4
Two-Lane Highways.....	Section 20.1.3.3
Types	Section 15.2.2
INTERSECTION SIGHT DISTANCE.....	Section 10.4, Section 15.2.10

INTERSTATE SYSTEM	Section 7.1.2
ISLANDS	Section 15.4, Section 15.6
-J-	
JURISDICTIONAL SYSTEMS	
County Road System	Section 7.3.2, Section 22.1.3.2
Federal Lands	Section 7.3.4
Municipal System	Section 7.3.3, Section 22.1.3.3
National Network (Trucks).....	Section 7.3.5
State Highway System	Section 7.3.1, Section 22.1.3.1, Section 22.1.4
JURISDICTIONAL TRANSFERS	Section 22.1.3.4
-K-	
-L-	
LANDSCAPING	
Plans	Section 34.2.11
Principals.....	Section 17.3
Shrubs And Plants	Section 35.6.6
LANES	
Climbing	Section 12.4, Section 20.1.3.4
Freeway Lane Drops	Section 19.5.1
Parking	Section 17.1.5, Section 21.2.8
Passing	Section 20.1.3.5
Travel — see TRAVELED WAY	
Turn Lanes — see TURN LANES	
Two-Way, Left-Turn — see TWO-WAY, LEFT TURN LANES	
LAWS AND REGULATIONS	Section 2.1
LETTINGS.....	Chapter 3, Section 37.1, Section 37.2, Section 37.3
LEVEL OF SERVICE	
Guidance.....	Section 9.6.4.1, Section 15.2.8,
Freeways.....	Section 19.2, Section 19.3
Rural Highways	Section 20.1.4, Section 20.2.4
Urban/Suburban Streets.....	Section 21.2.2
Local Roads and Streets	Section 22.3
LIGHTING, HIGHWAY	Section 28.7, Section 34.2.10

LOCAL GOVERNMENTS	Section 4.3.2
LOCAL ROADS AND STREETS	
Definition	Section.9.4.1
Description	Section 22.1
Design Criteria	Section 22.3
Design Elements	Section 22.2
-M-	
MAILBOXES	Section 17.6
MAINTENANCE DIVISION	Section 1.3.2.2
<i>MANUAL ON UNIFORM TRAFFIC CONTROL DEVICES</i>	Section 28.3.1
MEDIANS	
Barriers.....	Section 13.4.2, Section 14.7
Design.....	Section 13.4
Openings.....	Section 15.7
Selection	Section 13.4.3
Types	Section 13.4.2, Section 20.2.1.5, Section 21.2.6
Width.....	Section 13.4.2
MOWING.....	Section 35.6.8
MULTILANE RURAL HIGHWAYS.....	Section 20.2
MUNICIPAL SYSTEM.....	Section 7.3.3, Section 22.1.3.3
-N-	
NATIONAL HIGHWAY SYSTEM	Section 7.1.1
NATIONAL NETWORK (TRUCKS).....	Section 7.3.5
NATIONAL POLLUTANT DISCHARGE ELIMINATION SYSTEM (NPDES).....	Section 29.2.3, Section 30.3.3
NEPA PROCESS.....	Chapter 3, Section 27.3
NOISE BARRIERS – see NOISE CONTROL	
NOISE CONTROL	
Analysis.....	Section 27.4
Barriers.....	Section 17.4.6, Section 19.5.5
Design.....	Section 17.4
Plans	Section 34.2.15

-O-**ORGANIZATION, SCDOT**

Department of Transportation Commission.....	Section 1.1
Deputy Director of Construction, Engineering and Planning	Section 1.2.1, Section 1.3
Deputy Director of Executive Support	Section 1.2.4, Section 1.6
Deputy Director of Strategic Planning, Finance and Administration	Section 1.2.2, Section 1.4
Deputy Director of Mass Transit.....	Section 1.2.3, Section 1.5
Executive Director	Section 1.2

-P-**PARKING**

Disabled Accessibility.....	Section 17.1.5
On-Street.....	Section 13.2.6, Section 21.2.8
Widths	Section 21.2.8, Section 21.3, Section 22.3

PARTICIPATION AGREEMENTS.....	Section 2.4
-------------------------------	-------------

PASSING LANES	Section 20.1.3.5
---------------------	------------------

PASSING SIGHT DISTANCE	Section 10.2, Section 20.1.3.1
------------------------------	--------------------------------

PAVEMENT

Design.....	Chapter 3
Quantities	Section 35.3
Surface Type.....	Section 13.2.2

PAVEMENT MARKINGS

Bridges	Section 28.3.3.4
Plans	Section 34.2.12
Quantities	Section 35.4
Types	Section 28.3.3

PEDESTRIANS

Disabled Accessibility.....	Section 17.1.6, Section 17.1.7
Freeways.....	Section 19.5.4
Sidewalks	Section 13.2.6, Section 21.2.10

PERMITS

Encroachment	Section 5.3.2
Environmental	Chapter 3, Section 27.5

PLAN DEVELOPMENT

Construction Phase	Section 33.6
Design Field Review	Section 34.2
Design Process	Section 33.1
Drafting Guidelines.....	Section 34.1
Final Construction Plans	Chapter 3, Section 33.4, Section 33.5
Plan Revisions	Section 33.6.3
Plan Sheets.....	Section 34.2
Plan Storage	Section 33.6.1
Process	Chapter 3, Section 33.1
Public Access.....	Section 33.7
Railroads	Section 6.3
Right of Way Plans.....	Section 33.3

PLANNING DIVISION	Section 1.3.1.1, Section 4.1.2
-------------------------	--------------------------------

PLAN SHEETS

Bridge Plans.....	Section 34.2.19
Cross Sections	Section 34.2.18
Details of Plan Sheets	Section 34.2.8
Electrical and Lighting Plans	Section 34.2.10
Erosion Control	Section 34.2.16
General Construction Sheet	Section 34.2.6
Landscaping Plans	Section 34.2.11
Pavement Marking Plans	Section 34.2.12
Plan and Profile Sheets.....	Section 34.2.7
Plan Cover	Section 34.2.1
Removal and Disposal Items Sheet	Section 34.2.3.2
Roadway Structure Plans.....	Section 34.2.15
Right of Way Sheets	Section 34.2.5
Sequence of Construction and Traffic Control Plan	Section 34.2.9
Sheet Organization	Section 34.1.5
Signing Plans	Section 34.2.13
Summary of Estimated Quantity Sheet	Section 34.2.3
Title Sheet.....	Section 33.4.1, Section 34.2.2
Traffic Data Sheets	Section 34.2.5
Traffic Signal Plans	Section 34.2.14
Typical Plan Sheets	Section 34.2.4
Utility/Utility Relocation Sheets.....	Section 34.2.17

PRECONSTRUCTION DIVISION	Section 1.3.1.2, Section 4.2
--------------------------------	------------------------------

PRELIMINARY FIELD REVIEW — see DESIGN FIELD REVIEW

PROFILE GRADE LINE	Section 12.2.3
--------------------------	----------------

PROGRAM ACTION REQUEST	Chapter 3
------------------------------	-----------

PROGRAM DEVELOPMENT SECTION.....	Section 1.3.1.2.1, Chapter 3, Section 4.2.1
PROGRAM MANAGEMENT SECTION.....	Section 1.3.1, Section 2.2, Chapter 3
PROJECT DEVELOPMENT PROCESS.....	Chapter 3, Section 33.1, Chapter 37
PROJECT PLANNING REPORT.....	Chapter 3, Section 33.2.1
PROJECT SCOPE OF WORK.....	Section 9.3
PUBLIC	
Access to Plans.....	Section 33.7
Hearings/Meetings.....	Chapter 3, Section 30.2, Section 33.7.1
Involvement.....	Section 2.5

-Q-

QUALITY ASSURANCE/QUALITY CONTROL.....	Section 2.2.2
QUANTITIES	
Bridges.....	Section 35.6.9
Drainage.....	Section 35.5
Driveways.....	Section 35.6.3
Earthwork.....	Section 35.2
Fences or Walls.....	Section 35.6.2
Guardrail.....	Section 35.6.1
Miscellaneous.....	Section 35.6
Mowing.....	Section 35.6.8
NPDES.....	Section 30.3.3.2
Preparing.....	Section 35.1
Revisions.....	Section 33.6.3.3
Roadway.....	Section 35.3
Seeding and Sodding.....	Section 35.6.7
Shrubs And Plants.....	Section 35.6.6
Summary of Estimated Quantities Sheets.....	Section 34.2.3, Section 35.1.1
Traffic Items.....	Section 35.4
Underground Storage Tanks.....	Section 35.6.2

-R-

RADII, HORIZONTAL.....	Section 11.2.3
RADII, INTERSECTION.....	Section 15.3
RAILROADS	
At-Grade Crossings.....	Section 6.2.1.1, Section 15.8, Section 28.6

Coordination.....	Chapter 3, Section 4.2.7, Section 6.2
Design.....	Section 6.2, Section 15.8
Drainage.....	Section 6.2.2
Grade Separations.....	Section 6.2.1.2
Parallel/Close Proximity Location Restrictions.....	Section 6.2.1.3, Section 15.8
Plans.....	Section 6.3, Section 33.3.7
Right of Way.....	Section 6.2.4
Sidewalks.....	Section 6.2.3
Surveys.....	Section 26.2.3
RAISED MEDIANS.....	Section 13.4.2.2
RAMPS	
Curb Ramps.....	Section 17.1.10
Disabled Accessibility.....	Section 17.1.9
Freeway Entrance.....	Section 16.4.2
Freeway Exit.....	Section 16.4.1
Interchange.....	Section 16.5
RESEARCH AND MATERIALS LABORATORY.....	Section 1.3.2.1.3, Chapter 3
RETAINING WALLS.....	Section 14.4.10, Section 17.2, Section 34.2.15
REVISIONS, <i>SCDOT HIGHWAY DESIGN MANUAL</i>.....	Introduction
RIGHT OF WAY	
3R Projects.....	Section 23.4.5
Access Control.....	Section 9.8, Section 30.3.6
Coordination.....	Section 4.2.3, Section 30.2
Cost Estimates.....	Section 36.1
Design.....	Section 30.3
Elements.....	Section 30.4
General.....	Section 30.1
Limits.....	Section 33.3.11
NPDES.....	Section 30.3.3
Office.....	Section 1.3.1.2.5
Plans.....	Chapter 3, Section 4.2.3, Section 34.2.5
Railroad.....	Chapter 3, Section 6.2.4
Right of Way Acquisition.....	Section 31.1.2
Utilities.....	Chapter 3, Section 5.3
Width.....	Section 30.3.2
RIPRAP.....	Section 35.5.1
<i>ROAD DESIGN PLAN PREPARATION GUIDE</i>.....	Section 31.1.5
ROAD DESIGN SECTION.....	Section 1.3.1.2.6, Section 4.2.8

ROADSIDE SAFETY

3R Projects.....	Section 23.4.9
Application.....	Section 14.1
Barriers.....	Section 14.5, Section 14.6
Clear Zones.....	Section 14.3, Section 23.4.9
Impact Attenuators.....	Section 14.8
Local Roads and Streets.....	Section 22.2.5
Median Barriers.....	Section 14.7

ROCK CUTS — see SLOPES

RRR (3R) PROJECTS

Background.....	Section 23.2
Procedures.....	Section 23.3
Design.....	Section 23.4

RUMBLE STRIPS.....	Section 13.2.4
--------------------	----------------

RURAL HIGHWAYS

Freeways.....	Section 19.1
Multilane Highways.....	Section 20.2
Two-Lane Highways.....	Section 20.1

-S-

SAFETY OFFICE.....	Section 1.3.2.5
--------------------	-----------------

SCOPE OF WORK.....	Chapter 3, Section 9.3
--------------------	------------------------

SHOULDERS

Cross Slopes.....	Section 13.2.4.3
Freeways.....	Section 19.2.5.1, Section 19.3
Function.....	Section 13.2.4
Local Roads and Streets.....	Section 22.3
Rumble Strips.....	Section 13.2.4.4
Rural.....	Section 20.1.4, Section 20.2.4
Urban.....	Section 21.3
Widths.....	Section 13.2.4

SIDEWALKS

Design.....	Section 21.2.10
Disabled Accessibility.....	Section 17.1.6, Section 17.1.7
Guidelines.....	Section 13.2.6, Section 21.2.10
Railroad.....	Section 6.2.3

SIGHT DISTANCE

Decision Sight Distance.....	Section 10.3
Horizontal.....	Section 11.4

Interchanges	Section 16.4.1.4, Section 16.4.2.4
Intersection.....	Section 10.4
Passing	Section 10.2, Section 20.1.3.1
Railroad/Highway Grade Crossing.....	Section 15.8.3
Ramps.....	Section 16.5.3
Stopping	Section 10.1
 SIGNALS – see Traffic Signals	
SIGNS	
Plans	Section 34.2.13
Design.....	Section 28.3.2
 SLOPES	
Clear Zones.....	Section 14.3.2
Cut Slopes.....	Section 13.3.1.3
Ditches	Chapter 13.3.1.4, Section 14.4.7
Fill Slopes.....	Section 13.3.1.2, Section 14.3.3
Foreslopes	Section 14.4
Freeways.....	Section 19.3
Local Roads and Streets.....	Section 22.3
Roadside Barriers	Section 14.4
Rock Cuts.....	Section 13.3.1, Section 14.4.8
Rural Highways	Section 20.1.4, Section 20.2.4
Urban Streets.....	Section 21.3
 SPEED	
SPEED	Section 9.5
STAIRS	Section 17.1.8
STANDARD DRAWINGS, SCDOT	Section 31.1.6.2
STANDARD SPECIFICATIONS FOR HIGHWAY CONSTRUCTION	Section 31.1.4.1
STATE FUNDING	Section 7.2
STATE HIGHWAY SYSTEM.....	Section 7.3.1, Section 22.1.3.1, Section 22.1.4
STOPPING SIGHT DISTANCE.....	Section 10.1
 SUBURBAN/URBAN STREETS	
Design Criteria	Section 21.3
Design Elements	Section 21.2
Functional Classification.....	Section 21.1
Subdivision Streets	Section 22.1.4
 SUMMARIES, QUANTITIES	
SUMMARIES, QUANTITIES	Section 34.2.3, Section 35.1

SUPERELEVATION

Bridges	Section 11.3.7
Compound Curves	Section 11.3.5
Drainage.....	Section 11.3.8
Freeway/Ramp Junctions.....	Section 16.4
Point of Revolutions	Section 11.3.3
Ramps.....	Section 16.5.5
Rates.....	Section 11.3.1
Reverse Curves	Section 11.3.6
Shoulder.....	Section 11.3.4, Section 13.2.4.3
Transition Length	Section 11.3.2

SURFACE TRANSPORTATION PROGRAM.....	Section 7.1.3
-------------------------------------	---------------

SURVEY

Coordination.....	Section 4.2.6
Conducting	Chapter 3, Section 1.3.1.2.3
Disabled Accessibility.....	Section 17.1
Elements	Section 26.1
Office.....	Section 1.3.1.2.3
Requirements.....	Section 26.2
<i>Survey Manual</i>	Section 31.1.7

-T-

TAPERS

Interchanges	Section 16.4.1, Section 16.4.2
Turning Lanes	Section 15.5.2

TRAFFIC CALMING.....	Section 28.8, Section 31.1.3.6
----------------------	--------------------------------

TRAFFIC CONTROL DEVICES

Manual on Uniform Traffic Control Devices.....	Section 28.3.1, Section 31.2.4
Pavement Markings	Section 28.3.3
Quantities	Section 35.4
Roadside Safety.....	Section 14.4.11
Right of Way.....	Section 30.3.8
Signs	Section 28.3.2
Traffic Signals	Section 28.3.4

TRAFFIC CONTROL PLANS — see WORKZONE TRAFFIC CONTROL

TRAFFIC ENGINEERING

Coordination.....	Section 4.1.1
Division.....	Section 1.3.2.3
Documents	Section 31.1.3
Highway Capacity	Section 28.2
Highway Geometry.....	Section 28.1
Highway Lighting.....	Section 28.7

Intelligent Transportation Systems	Section 28.5
Plans	Chapter 3, Section 34.2
Project Development	Chapter 3
Railroad Grade Crossings	Section 28.6
Traffic Control Devices	Section 28.3
Work Zone Traffic Control	Section 28.4, Section 34.2.9

TRAFFIC MANAGEMENT – see WORK ZONE TRAFFIC CONTROL

TRAFFIC SIGNALS

Disabled Accessibility	Section 17.1
Intersections	Section 15.2.9
Intersection Sight Distance	Section 15.2.10
Plans	Section 34.2.14
Railroad/Highway Grade Crossings	Section 15.8.2
Traffic Signal Design Guidelines	Section 31.1.3.7
Warrants/Guidelines	Section 28.3.4

TRAFFIC VOLUME CONTROLS

Capacity	Section 9.6.4
Clear Zone	Section 14.3.2.3
Definitions	Section 9.6.1
Design Hourly Volume	Section 9.6.3
Design Year Selection	Section 9.6.2
Freeways	Section 19.2.1.2
Local Roads and Streets	Section 22.2.1
Multilane Highways	Section 20.2.1.1
Suburban/Urban Streets	Section 22.2.1

TRANSITIONS

Clear Zones	Section 14.3
Horizontal Sight Distance	Section 11.4
Intersections	Section 15.2
Two-Lane to Multilane Highways	Section 20.2.2
Superelevation	Section 11.3

TRAVELED WAY

Bicycles	Section 13.2.3
Cross Slopes	Section 13.2.3
Freeways	Section 19.2.5.1, Section 19.3
Local Roads and Streets	Section 22.3
Reductions	Section 13.5.3
Rural Highways	Section 20.1.4, Section 20.2.4
Urban Streets	Section 21.3
Widening	Section 11.2.6
Widths	Section 13.2.3, Section 13.5.3

TRUCKS

Climbing Lanes	Section 12.4, Section 20.1.3.4
Design Vehicle	Section 9.7
Interchanges	Section 16.4.2
Intersection Sight Distance.....	Section 10.4
National Network.....	Section 7.3.5

TURNING RADII	Section 15.3
---------------------	--------------

TURNING ROADWAYS	Section 15.4
------------------------	--------------

TURN LANES

Design	Section 15.5.2, Section 15.5.3
Dual-Turn Lanes	Section 15.5.4
Guidelines	Section 15.5.1

TWO-LANE RURAL HIGHWAYS

Alternatives to Widening.....	Section 20.1.3
Design.....	Section 20.1.2, Section 20.1.4
Scoping.....	Section 20.1.1
Truck Climbing Lanes.....	Section 12.4

TWO-WAY, LEFT-TURN LANES	Section 13.4.2.1, Section 20.1.3.2, Section 21.2.7
--------------------------------	---

TYPICAL SECTIONS

Plans	Section 33.2.7, Section 34.2.4
Typical Sections	Section 13.2.1, Section 19.2.5.2, Section 20.1.2.4, Section 20.2.1.4, Section 21.2.5, Section 22.2.7

-U-

UNDERGROUND STORAGE TANKS	Section 34.2.3.2.3, Section 35.6.2
---------------------------------	---------------------------------------

UNDERPASSES

Cross Section.....	Section 13.5.2
Freeways.....	Section 19.4.2.3
Pavement Transitions.....	Section 13.5.2, Section 13.5.3
Vertical Clearances	Section 13.5.1, Section 12.6

UTILITIES

Coordination.....	Chapter 3, Section 4.2.7, Section 5.3
Design.....	Section 5.3
Encroachment Permits.....	Section 5.3.2
Office.....	Section 1.3.1.2.3

Plans	Section 34.2.17
Railroads	Chapter 3, Section 4.2.7, Chapter 6
Subsurface Utility Engineering	Section 5.2
Survey	Section 26.2.1

-V-

VALUE ENGINEERING	Section 2.7
-------------------------	-------------

VERTICAL ALIGNMENT

3R Projects	Section 23.4.6
Computations	Section 12.5.3
Controls	Section 12.2
Freeway/Ramp Junctions	Section 16.5.6
Grades	Section 12.2, Section 12.3
Intersections	Section 15.2.7
Profile Grade Line	Section 12.2.3
Railroad/Highway Grade Crossings	Section 15.8.5
Ramps	Section 16.5.6
Truck-Climbing Lanes	Section 12.4
Vertical Curves	Section 12.5

VERTICAL CLEARANCES	Section 12.6, Section 13.5.1, Section 19.3, Section 20.1.4, Section 20.2.4, Section 21.3, Section 22.3
---------------------------	---

VERTICAL CURVES	Section 12.5
-----------------------	--------------

-W-

WEAVING

Freeways	Section 19.5.2
Interchanges	Section 16.3.7

WETLANDS	Section 27.4
----------------	--------------

WORKZONE TRAFFIC CONTROL	Section 28.4, Section 34.2.9
--------------------------------	------------------------------

-X-**-Y-****-Z-**

