

Chapter 17

EMBANKMENTS

GEOTECHNICAL DESIGN MANUAL

January 2022

Table of Contents

<u>Section</u>	<u>Page</u>
17.1 Introduction.....	17-1
17.2 LRFD Slope Stability.....	17-2
17.3 Failure Mechanisms.....	17-3
17.3.1 Creep.....	17-4
17.3.2 Slide.....	17-4
17.3.3 Flow.....	17-7
17.3.4 Spread.....	17-8
17.3.5 Fall and Topple.....	17-9
17.4 Loading Conditions.....	17-10
17.4.1 End-of-Construction Condition.....	17-12
17.4.2 Long-term Condition.....	17-12
17.4.3 Seismic (EE I) Event Condition.....	17-13
17.4.4 Vertically Staged Construction Condition.....	17-13
17.4.5 Rapid Drawdown Condition.....	17-13
17.4.6 Surcharge Loading Condition.....	17-13
17.4.7 Partial Submergence Condition.....	17-14
17.5 Slope Stability Analysis.....	17-14
17.5.1 Ordinary Method of Slices.....	17-15
17.5.2 Simplified Bishop.....	17-15
17.5.3 Force Equilibrium.....	17-15
17.5.4 Spencer's Method.....	17-16
17.5.5 Morgenstern and Price Method.....	17-16
17.6 Settlement – General.....	17-16
17.7 Change In Stress.....	17-17
17.7.1 Shallow Foundations.....	17-17
17.7.2 Embankments.....	17-20
17.7.3 Buried Structures.....	17-25
17.8 Immediate Settlement.....	17-25
17.8.1 Sand-Like Soils.....	17-25
17.8.2 Clay-Like Soils.....	17-33
17.9 Primary Consolidation Settlement.....	17-34
17.9.1 Amount of Settlement.....	17-35
17.9.2 Time for Settlement.....	17-37
17.10 Secondary Compression Settlement.....	17-38
17.11 Settlement in Rock.....	17-40
17.12 Lateral Squeeze.....	17-43
17.13 Embankment Design.....	17-45
17.13.1 Unreinforced Embankments.....	17-47
17.13.2 Reinforced Embankments.....	17-50
17.13.3 Reinforced Soil Slopes.....	17-56
17.13.4 Vertical Stage Construction.....	17-58
17.13.5 Cut Slopes.....	17-60
17.13.6 Pipe Culverts.....	17-61
17.14 Plans.....	17-61
17.15 References.....	17-61

List of Tables

<u>Table</u>	<u>Page</u>
Table 17-1, No External Slope Stability Analysis	17-2
Table 17-2, Width Correction Factor, C_B	17-29
Table 17-3, Time Rate Factors.....	17-29
Table 17-4, Correlation Factor, F_s	17-32
Table 17-5, Vertical Strain Influence Factor Equations	17-32
Table 17-6, Footing Shape and Rigidity Factors.....	17-33
Table 17-7, Primary Consolidation Settlement Steps.....	17-35
Table 17-8, Primary Consolidation Settlement Equations	17-36
Table 17-9, Secondary Compression Settlement Equations.....	17-39
Table 17-10, Rock Settlements on various Geological Conditions.....	17-41
Table 17-11, Shape Factors, C_d	17-42
Table 17-12, Shape Factors, C'_d	17-43
Table 17-13, Elastic Distortion Settlement Correction Factor, α	17-43
Table 17-14, RSS Design Steps.....	17-57
Table 17-15, Rippability Chart.....	17-60

List of Figures

<u>Figure</u>	<u>Page</u>
Figure 17-1, Signs of Creep	17-4
Figure 17-2, Translational Slide.....	17-5
Figure 17-3, Rotational Slide	17-6
Figure 17-4, Compound Slide.....	17-7
Figure 17-5, Flow Failures.....	17-8
Figure 17-6, Spread Failure.....	17-9
Figure 17-7, Fall Failure	17-9
Figure 17-8, Topple Failure	17-10
Figure 17-9, Stress Isobars	17-17
Figure 17-10, Influence Factor Chart.....	17-19
Figure 17-11, Principle of Superposition.....	17-20
Figure 17-12, Influence Factor Chart – Infinitely Long Embankments.....	17-21
Figure 17-13, Influence Chart Beneath Crest of Slope	17-22
Figure 17-14, Influence Chart Beneath Toe of Slope.....	17-23
Figure 17-15, Pressure Coefficients Beneath the End of a Fill.....	17-24
Figure 17-16, Bearing Capacity Index Chart.....	17-27
Figure 17-17, Vertical Strain Influence Factor Chart.....	17-31
Figure 17-18, Janbu Influence Factor Chart	17-34
Figure 17-19, Secondary Compression	17-39
Figure 17-20, Schematic of Lateral Squeeze.....	17-44
Figure 17-21, Lateral Squeeze Model	17-44
Figure 17-22, ERS vs Slope Diagram.....	17-46
Figure 17-23, Construction-Point Concept.....	17-47
Figure 17-24, Reinforced Embankment Failure Modes.....	17-50
Figure 17-25, Reinforced Embankment Applications	17-51
Figure 17-26, Rotational Failure Model.....	17-51
Figure 17-27, Sliding Failure – Rupture of Reinforcement	17-52
Figure 17-28, Sliding Failure of Embankment over Reinforcement.....	17-52
Figure 17-29, Reinforced Embankment Construction Sequence over Soft Ground ..	17-54
Figure 17-30, Fill Placement over Soft Ground.....	17-55
Figure 17-31, Fill Placement over Firm Ground.....	17-55
Figure 17-32, Geosynthetic Reinforcement Placement for Widened Embankments .	17-56
Figure 17-33, Reinforced Soil Slope.....	17-57
Figure 17-34, Reinforced Soil Slope Failure Modes	17-58
Figure 17-35, Staged Construction Schematic	17-59

CHAPTER 17

EMBANKMENTS

17.1 INTRODUCTION

This Chapter provides general guidance in stability and settlement design and analysis of embankments. Embankments typically consist of unreinforced soil slopes, reinforced embankments and Reinforced Soil Slopes (RSSs) and may also include ERSs (see Chapter 18) constructed within the SCDOT ROW or belonging to SCDOT. This Chapter is concerned with the external stability of embankments and ERSs. The internal stability of ERSs, depending on the type, is the responsibility of the SEOR. The settlement of earthen embankments, ERSs, and foundations (shallow and deep) is also discussed in this Chapter. The amount of settlement is for the Strength and Service limit states. Strength limit state settlements are used to determine if any additional forces are induced in the structure by this settlement. Service limit state settlements are used to evaluate the performance on the structure using Service loading conditions. Settlements induced by the EE I limit state are discussed in Chapter 13 and are applicable only to bridge embankments and ERSs. Neither stability nor settlement need to be checked for roadway embankments including RSSs and reinforced embankments at the EE I limit state. The amount of total and differential settlement shall be determined. All settlements shall be determined for a 20-year period, unless specifically directed by the OES/GDS to use another time period. However, the design life of all embankments is 100 years. The 20-year period is used to coincide with the anticipated pavement replacement/rehabilitation cycle.

Stability and settlement should be determined on the critical section. The selection of the critical section or sections is left to the GEOR. The following are suggested guidelines for use in this selection process:

1. Highest slope or ERS
2. Steepest slope
3. Soft underlying soils
4. Slope or ERS critical to performance of a structure (i.e., bridge, culvert, etc.)

In the case of a bridge embankment (see Chapter 2), the global stability of the front slope (see Chapters 2 and 10) is determined along the longitudinal axis of the project for the Extreme Event limit state check. Typically global instability along the longitudinal axis of the project has the greatest potential for impacting the bridge; therefore, in the transverse direction within the front slope similar results are anticipated. However, if in the opinion of the GEOR the global stability in the transverse direction may impact the bridge at the Extreme Event limit state, then the GEOR may perform global stability analysis in the transverse direction within the front slope.

There are 2 applications of embankments used by SCDOT: bridge and roadway (defined in Chapter 2). All embankments regardless of type of embankment (i.e., unreinforced slope, RSS, etc.) shall have slope stability and settlement checked at the appropriate limit state. Cut slopes shall have slope stability checked at the appropriate limit state. However, embankments and cut slopes meeting the criteria presented in Table 17-1 are not required to have external slope stability analyses. All ERSs shall have slope stability and settlement checked for all limit states (see Chapter 8).

Table 17-1, No External Slope Stability Analysis

Embankment Slope	Total Embankment/Slope Height¹
2H:1V	≤ 10 ft
3H:1V or flatter	≤ 15 ft

¹Includes the design scour depth

The exception to the No External Slope Stability Analysis concept is if in the opinion of the GEOR that the analysis is required. In addition, a stability analysis for slopes flatter than 3H:1V may be performed if in the opinion of the GEOR it is required. Additionally, if structural reinforcement is required to limit settlement then an analysis will be required. If reinforcement is placed within the embankment as an aide to construction (see Chapter 19) then the No External Analysis concept may be used provided the criteria provided in Table 17-1 is met.

Embankments can be divided into 2 main categories: natural and man-made. Natural embankments are those slopes formed by natural processes and are composed of natural materials. Natural embankments may include river banks to the valleys passing through or parallel to mountain ridges. Man-made embankments are those slopes and ERSs that are constructed by man. Man-made embankments may be subdivided into 2 types of embankments: fill (bottom up construction) and cut (top down construction). Fill slopes, including ERSs, are constructed by placing soil materials to elevate the grade above the natural or existing grade. Fill slopes may be unreinforced or reinforced. Cut slopes, including ERSs, are constructed by excavating material from either a natural or man-made fill slopes in order to reduce the grade. The stability and settlement procedures discussed in this Chapter exclusively apply to slopes constructed of soil and founded on either soil or rock materials. For the design of slopes in rock see FHWA-HI-99-007 – *Rock Slopes* (Munfakh, Wylie, and Mah (1998)) for design procedures.

17.2 LRFD SLOPE STABILITY

Prior versions of the AASHTO Design Specifications recommended that the overall stability be performed at the Service limit state. The 9th Edition of AASHTO, however, has moved overall stability from the Service limit state to the Strength limit state. This change was precipitated by the need to bring overall stability more in line with LRFD theory and concepts. A slope failure is more likely to occur when the strength of the soil is exceeded. Since the currently available slope stability programs still use an ASD methodology and produce a single Safety Factor (SF), the basic ASD calculation methods will continue to be used. After completion of the analysis using ASD, the calculated SF is inversed to convert from ASD to LRFD.

$$\mathbf{Driving\ Forces\ (\sum q_i) \leq Resistance\ Forces\ (\sum r_i)} \quad \text{Equation 17-1}$$

In other words:

$$\mathbf{SF = \frac{\sum r_i}{\sum q_i}} \quad \text{Equation 17-2}$$

As indicated in Chapter 8, the basic LRFD equation is

$$\mathbf{Q = \sum \eta_i \gamma_i Q_i \leq \phi R_n = R_r} \quad \text{Equation 17-3}$$

Where,

- Q = Factored Load
- Q_i = Force Effect
- η_i = Load modifier
- γ_i = Load factor
- R_r = Factored Resistance (i.e., allowable capacity)
- R_n = Nominal Resistance (i.e., ultimate capacity)
- ϕ = Resistance Factor

With the change to Strength limit state checks, the overall stability shall be checked using the Strength I Load Combination (see Chapter 8). However, instead of using γ_p as required in Chapter 8, use a load factor (γ_i) of 1.0 for all loads required for the Strength I Load Condition. Therefore, Equation 17-3 can be rewritten:

$$Q = \sum Q \leq \phi \sum R_n \quad \text{Equation 17-4}$$

Rearranging Equation 17-4:

$$\frac{1}{\phi} = \frac{R_n}{Q} = \frac{\sum r_i}{\sum q_i} \quad \text{Equation 17-5}$$

Equating Equation 17-2 with Equation 17-5 produces

$$SF = \frac{\sum r_i}{\sum q_i} = \frac{1}{\phi} \quad \text{Equation 17-6}$$

Equation 17-6 may be rearranged and written as,

$$\phi = \frac{1}{SF} \quad \text{Equation 17-7}$$

Therefore, to obtain the required ϕ from typical slope stability software packages, the SF obtained is simply inversed. The lower the resistance factor the higher the Safety Factor.

17.3 FAILURE MECHANISMS

There are several failure mechanisms that affect embankments. The mechanisms of failure may dictate the required analysis method to be used to determine stability or instability. Further, the types of soil that the embankment is comprised of will also affect the failure mechanism. The different failure mechanisms are listed below:

- | | |
|--------------------|-------------------------------|
| 1. Creep | 4. Slide |
| 2. Flow | 5. Spread |
| 3. Fall and Topple | 6. Deformation and settlement |

17.3.1 Creep

Creep is the very slow movement of slopes, either natural or man-made, toward the toe and a more stable configuration. This movement can range up to approximately 1 inch per year. Slopes that creep can remain stable for extended periods of time. However, once the limit of the soil shear strength has been reached, the amount of movement may increase and the time for movement may decrease resulting in a rapid or sudden failure of the slope. Creep movements can be divided into 2 general types: seasonal and massive. Seasonal creep is the creep that occurs during successive seasons, such as freezing and thawing, or wetting and drying. The amount of seasonal creep can vary from year to year, but is always present. Seasonal creep extends to the depth limit of seasonal variations of moisture and temperature. Massive creep causes almost constant movement within the slope and is not affected by seasonal variations. Massive creep typically occurs in clay-rich soils. While the actual mechanism of massive creep is not fully understood, this type of creep can be attributed to exceeding some threshold shear strength that is below peak shear strength. This threshold shear strength may be a very small portion of the peak shear strength. If the stresses in the slope remain below the threshold level, then movement will not occur; however, if the stresses exceed the threshold, then movements will occur. If enough stresses accumulate to exceed the peak shear strength, then a more rapid failure is possible. In general, once creep has started it is difficult or impossible to stop. However, the rate of creep may be reduced by placement of drainage. During the Geoscoping of the project site, the trees should be observed for any convex curvature with the convex part pointing down slope (see Figure 17-1).

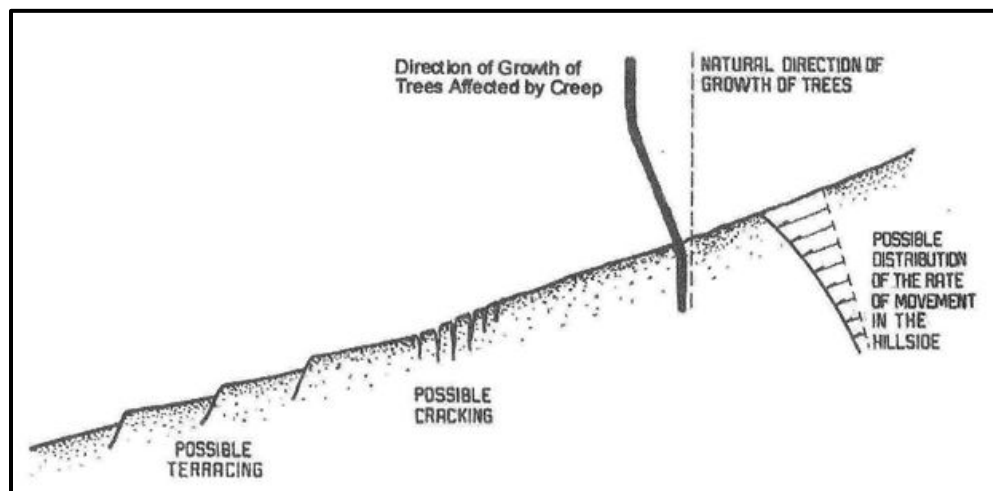
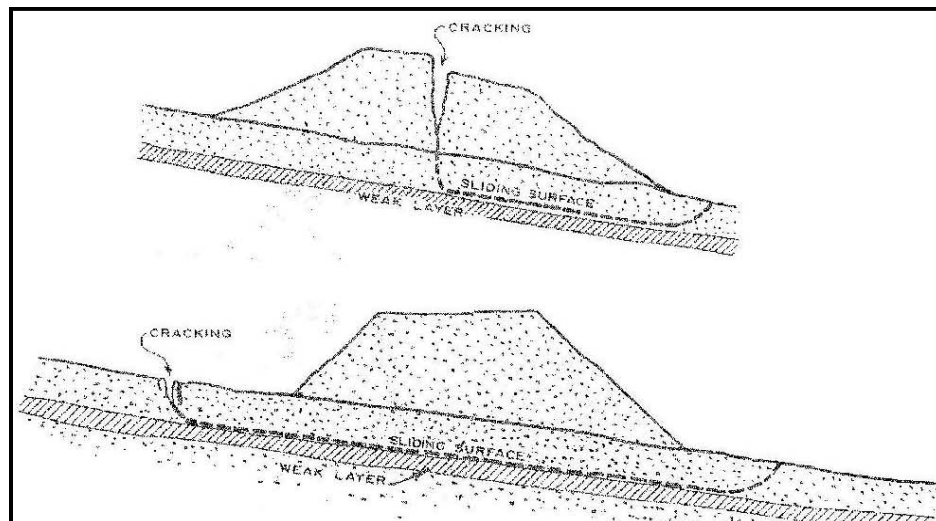

Figure 17-1, Signs of Creep
(Collin, Leshchinsky, and Hung (2005))

17.3.2 Slide

Slides are downward slope movements that occur along definite slip or sliding surfaces. Slides may be translational, rotational, or a composite of rotation and translation. Translational slides are typically shallow and linear in nature. Translational slides typically occur along thin weak layers or along the boundary between a firm overlying layer and weaker underlying layer (see Figure 17-2).



**Figure 17-2, Translational Slide
(Collin, Leshchinsky, and Hung (2005))**

Rotational slides are slides that form an arc along the shearing surface. This is the most common type of failure analyzed. In soft, relatively homogenous Clay-Like materials, the rotational slide forms a deep seated arc, while in Sand-Like materials the rotational slide failure surface tends to be relatively shallow. Examples of different types of rotational slides are depicted in Figure 17-3.

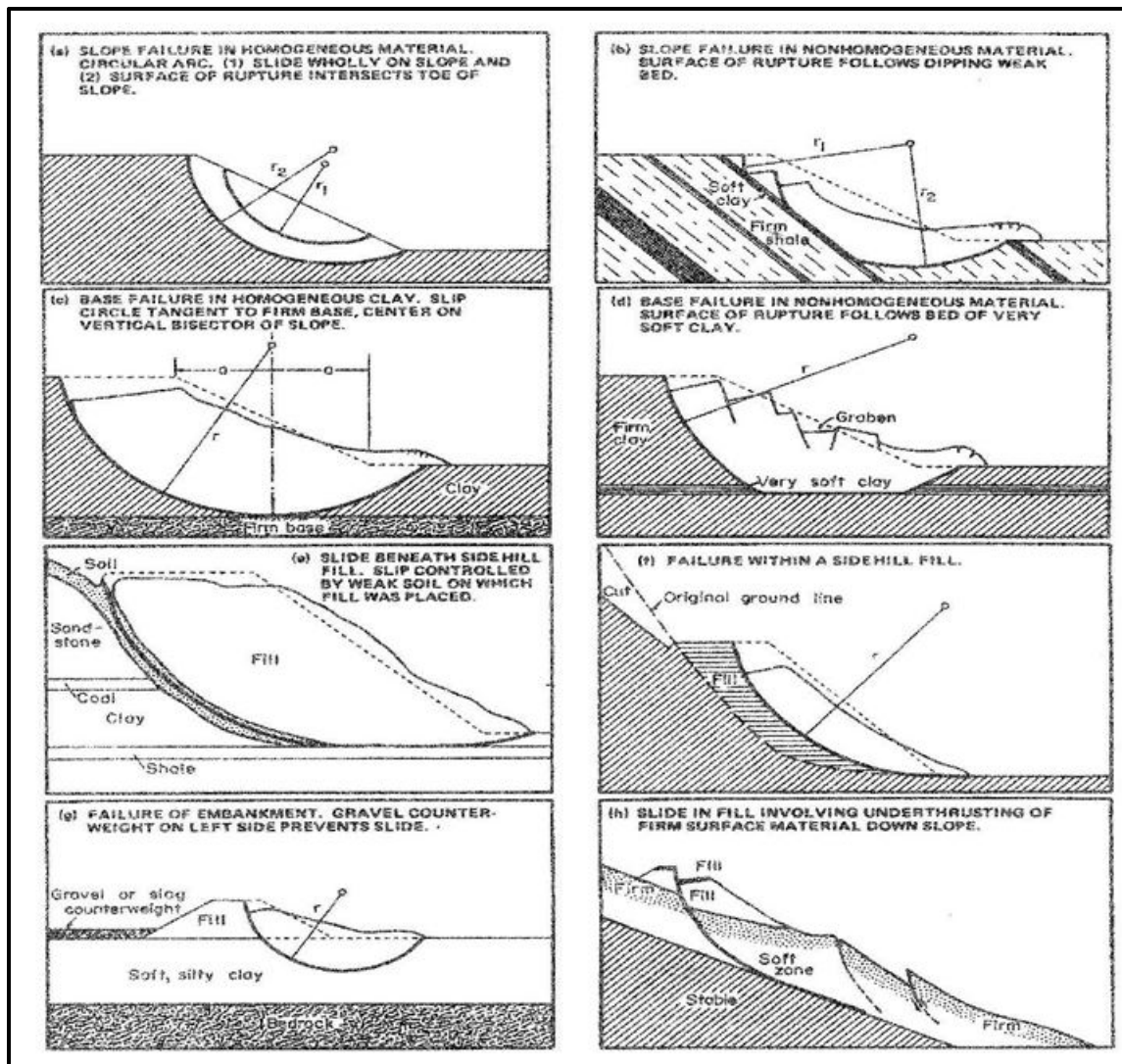

Figure 17-3, Rotational Slide
(Collin, Leshchinsky, and Hung (2005))

Compound slides are a composite of translational and rotational slides. This type of slide tends to have a complex structure and can be difficult to analyze. Compound slides can have 2 general forms: retrogressive and progressive. Retrogressive compound slides continue to cut into the existing slope. After initial failure, the new slope that is formed is unstable and fails, developing another new unstable slope face that fails. This slide type may result in a series of slides that tend to converge on one extended slope. Progressive slides occur when an existing slope surface is loaded with either new fill or debris from a slope failure, resulting in failure of the slope toward the toe. Compound slide types are depicted in Figure 17-4.

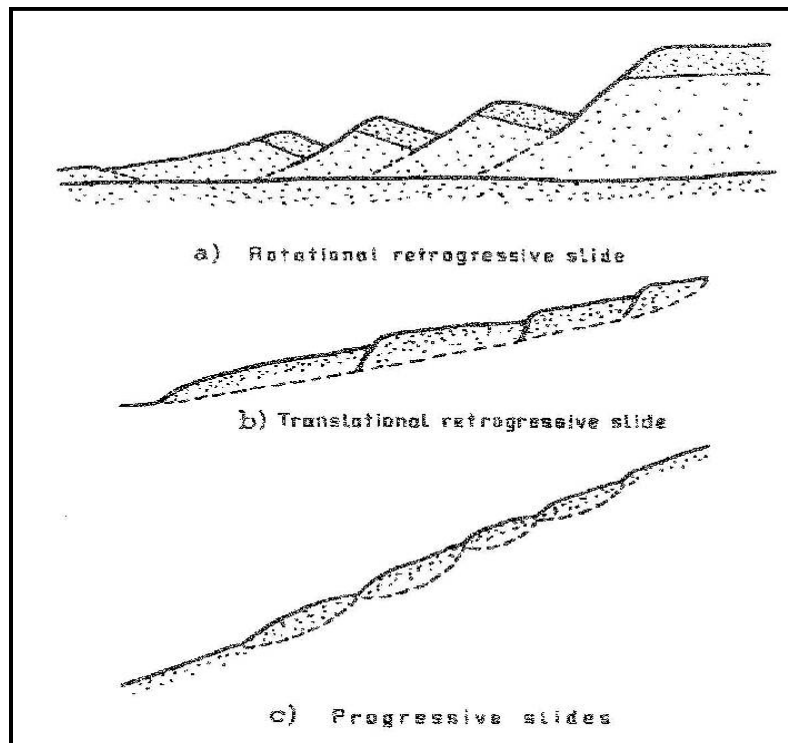

Figure 17-4, Compound Slide
(Collin, Leshchinsky, and Hung (2005))

17.3.3 Flow

Flow failures can occur in both dry, as well as wet soils, depending on the materials and the relative density. Flows are defined as mass soil movements that have greater internal deformations than slides. In a slide, the soil block will maintain some definition during sliding, whereas in flows, the definition of the block is completely lost. Flow failures, depending on the moisture condition of the soil, may behave similar to a fluid. In dry flow failures of fine-grained Sand-Like soils, the movements are caused by a combination of sliding and individual particle movements. These types of failures may be caused by soils being cut on steep slopes that are stable when first constructed, but become unstable with time. Dry flow failures are also termed earthflows. Moist flows occur in soils that have higher moisture contents than the soils in a dry flow. In Clay-Like soils, moist flows occur when the moisture content exceeds the liquid limit of the material. In Sand-Like soils, moist flows may occur when water becomes trapped in the soils by an impermeable barrier. Liquefaction is a form of moist flow that is caused by high moisture content and a seismic shock (see Chapter 13). Wet flows are also termed mudflows. See Figure 17-5 for dry and moist flow failure examples.

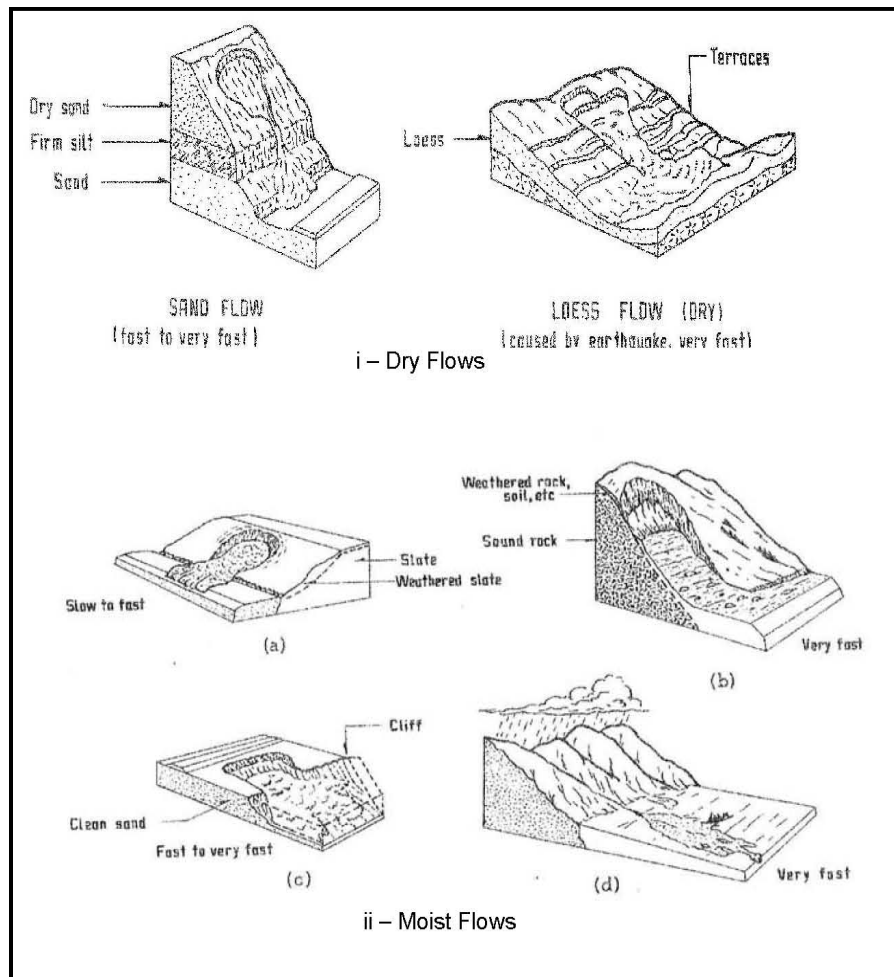

Figure 17-5, Flow Failures
 (Collin, Leshchinsky, and Hung (2005))

17.3.4 Spread

Spread was originally defined by Terzaghi and Peck in 1948 to describe sudden movements of water bearing seams of Sand-Like materials overlain by homogeneous Clay-Like soils or fills. Spreads occur on very gentle slopes (< 5 percent) or flat terrain. Spreads can occur in Sand-Like soils (liquefaction) or in Clay-Like soils (quick clays) that are externally loaded. In the case of liquefaction, the load is the seismic shock, and in quick clays, that load may be applied by the placement of fill materials. Figure 17-6 illustrates a typical soil spread.

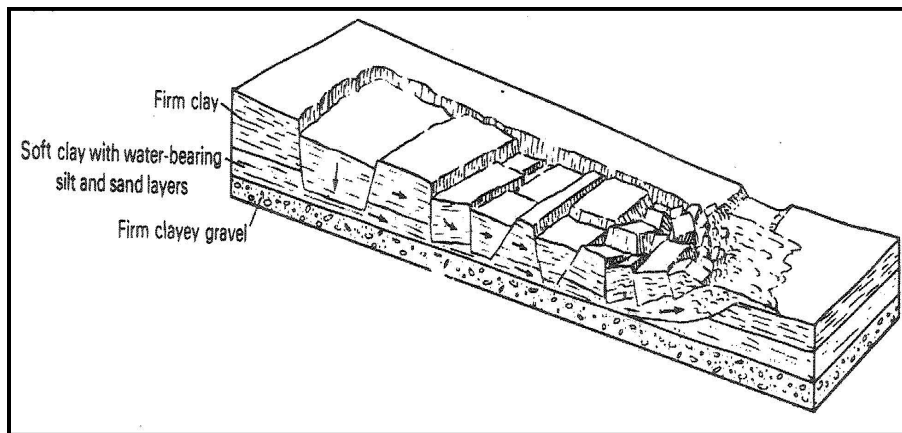

Figure 17-6, Spread Failure
(Collin, Leshchinsky, and Hung (2005))

17.3.5 Fall and Topples

Fall and topple failures typically occur on rock slopes, although, topples can occur in steeply cut or constructed soil slopes. Falls are sudden movements of rocks and boulders that have become detached from steep slopes or cliffs (see Figure 17-7). Cracks can form at the top of the steep slope that may fill with water that will exert pressure on the rock mass causing it to fall. The water may freeze during colder weather exerting pressure on the rock mass as well. A topple is the forward rotation of rock or soil mass around a pivot point in the mass (see Figure 17-8). The steepness of the slope affects the formation of the topple the slope can be constructed too steep or can be eroded to a steep configuration.

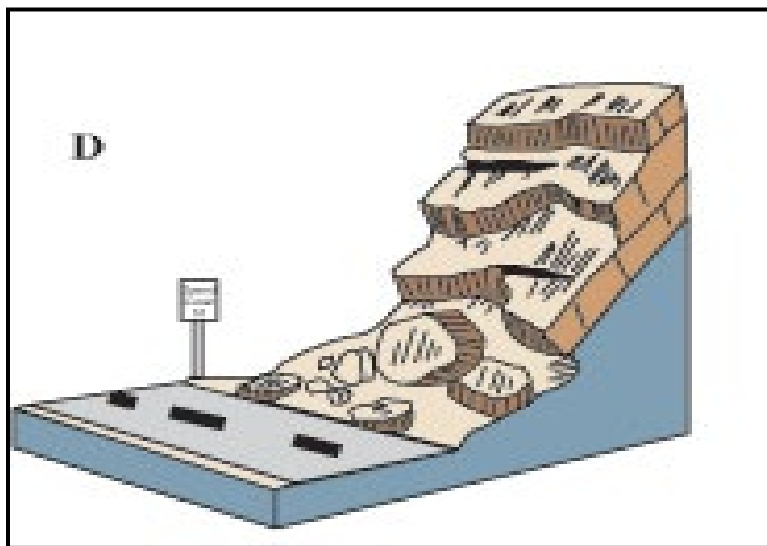

Figure 17-7, Fall Failure
(USGS (2004))

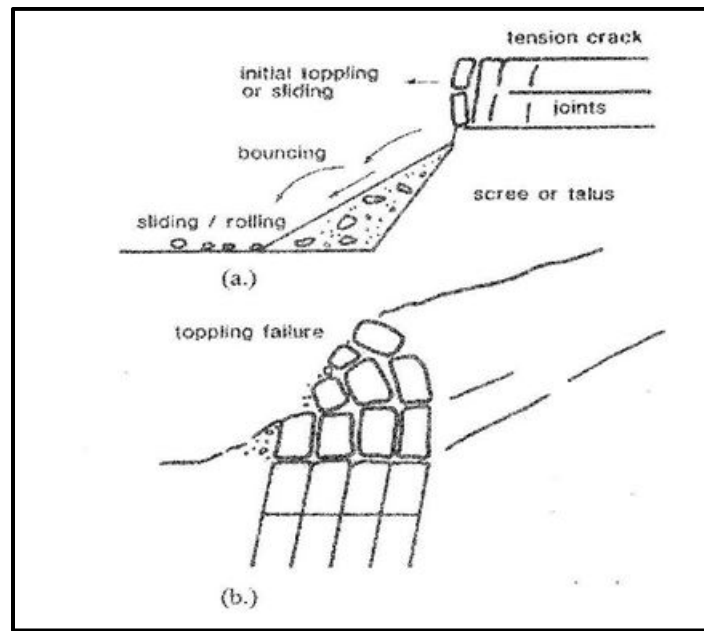

Figure 17-8, Tumble Failure
(Collin, Leshchinsky, and Hung (2005))

17.4 LOADING CONDITIONS

The stability of embankments is based on the height of the slope or ERS (i.e., the load) and the resistance of the subsurface soils (i.e., shear strength) to that loading. Increasing the height and steepness of the embankment increases the potential for instability. It is incumbent upon the GEOR to know and understand the loading conditions for which the stability analysis is being performed to evaluate. All of these loading conditions apply to both natural and man-made fill and cut embankments, but each condition does not have to be analyzed in every case. These loading conditions are listed below:

1. End-of-Construction (Short-term)
2. Long-term
3. Seismic (EE I)
4. Vertically Staged Construction
5. Rapid Drawdown
6. Surcharge Loading
7. Partial Submergence

Each of these loading conditions requires the selection of the appropriate soil strength parameters. Chapter 7 provides a more detailed discussion on the selection of drained and undrained soil shear strength parameters and the differences in total and effective stress. Once the rate of loading (i.e., loading condition) is determined, the soil response should be determined (i.e., drained or undrained). The drained response of soil is determined by loading the soil slowly enough to allow for the dissipation of pore pressures ($\Delta u = 0$). Conversely, the undrained response of a soil is determined by loading the soil faster than the pore pressures can dissipate ($\Delta u \neq 0$). This change in pore pressure can be either positive or negative depending on whether the soil compresses ($\Delta u > 0$) or dilates ($\Delta u < 0$). After determining the soil response (either drained or undrained), the type of analysis is selected based on the dissipation of pore pressures and the rate of loading. If the pore pressure increases with the application of load, i.e., during fast

loading on a fine-grained soil, then a total stress analysis is conducted. If the loading does not produce a change in pore pressure, i.e., during slow loading of a fine-grained soil or the loading is placed on coarse-grained material, then an effective stress analysis is conducted.

According to Duncan, Wright and Brandon (2014), “Whether slope stability analyses are performed for drained conditions or undrained conditions, the most basic requirement is that equilibrium must be satisfied in terms of total stress.” In other words, all forces, including water that act on the embankment, need to be accounted for in the stability analysis. The development of these forces allows for the determination of the total normal stress acting on the shear surface and the shear strength required to maintain equilibrium. Normal stresses are required to develop the soil shear strength ($\phi > 0^\circ$). The shear strength of cohesive, fine-grained ($\phi = 0^\circ$) is independent of the normal stress acting on the shear surface.

To develop effective stress shear strength parameters, the pore pressures along the shear surface need to be known and need to be subtracted from the total shear strength. For drained conditions, the pore pressures can be estimated using either hydrostatic or steady seepage boundary conditions. However, for undrained conditions, the pore pressures are a function of the response of the soil to shearing, therefore, the evaluation of the pore pressures is difficult. The development of total stress shear strength parameters does not require determination of pore pressures. Total stress analyses therefore can only be applied to undrained conditions. In total stress analyses, the pore pressures are determined as a function of the behavior of the soil during shear.

In drained soil response, the load is applied slow enough to allow for the dissipation of excess pore pressures ($\Delta u = 0$). An effective stress analysis is performed using:

- Total unit weights
- Effective stress shear strength parameters
- Pore pressures determined from hydrostatic water levels or steady seepage analysis

Total unit weights are required in drained soil response. Since the majority of the analytical software packages account for the location of the groundwater table, it is incumbent on the GEOR to know the requirements of the analytical software package and provide the correct input parameters.

In undrained soil response, the load is applied rapidly and excess pore pressures ($\Delta u > 0$) are allowed to build up. The pore pressures are controlled by the response of the soil to the application of the external load. A total stress analysis is performed using:

- Total unit weights
- Total stress shear strength parameters

The previous discussion dealt with the selection of total or effective stress strength parameters; however, these strength parameters are for peak shear strength. The use of peak shear strengths is appropriate for fill type slopes. However, the use of peak shear strength parameters in cut slopes should be considered questionable. Therefore, the use of residual shear strength shall be used in the design of permanent cut slopes. Residual shear strength should be either determined from laboratory testing or using the procedures outlined in Chapter 7. The location of the water

surface in cut slopes should be accounted for during design. The use of steady state seepage may be required, particularly, if the slopes intercepts the water table well above the toe of the slope. In addition, surface drainage features may be required to control the flow of groundwater as it exits the slope. The use of peak shear strengths is permitted in the design of temporary slopes or shoring walls (i.e., slopes or shoring walls that have a design life less than 5 years), unless in the opinion of the GEOR reduced shear strengths should be used. The GEOR shall explain in the Geotechnical Engineering Reports, the reasoning behind using shear strengths less than peak for the design of temporary slopes or shoring walls.

17.4.1 End-of-Construction Condition

The End-of-Construction condition also termed Short-term can have either drained or undrained soil response depending on the time for excess pore pressure ($\Delta u \neq 0$) dissipation. The time for excess pore pressure dissipation shall be determined using the method described in Chapter 7 or from consolidation testing of the embankment materials. If the time for pore pressure dissipation is determined to be days or weeks (typically Sand-Like soils), then drained soil response should be used. Conversely, if the time for pore pressure dissipation is months to years (typically, Clay-Like soils), then undrained soil response should be used. Engineering judgment should be used for the soils that have a time for pore pressure dissipation of weeks to months. The selection on the use of drained or undrained soil response should be based on the time for the completion of construction. In addition, the slope being analyzed may consist of materials that have both drained and undrained soil responses (i.e., the slope contains Sand-Like and Clay-Like materials). The soil response of each layer should be determined based on the time for dissipation of pore pressures in each layer.

For the End-of-Construction loading condition (Strength limit state) for embankments, the weight of the pavement and live load surcharges shall be applied. However the thickness of the pavement, and therefore the weight of the pavement, is ignored during this analysis (i.e., soil unit weights are used to finish grade). In addition, it is typical to assume that the live load is 250 pounds per square foot (psf). The loads should be determined as specified in Chapter 8. The load factor (γ_i) shall be taken as 1.0.

17.4.2 Long-term Condition

The Long-term condition should use a drained soil response model. The use of the drained soil response is based on the assumption that excess pore pressures have dissipated ($\Delta u = 0$). The time for dissipation of pore pressures should be determined, if the GEOR suspects that not enough time has passed to allow for the dissipation. The appropriate soil response should be selected (i.e., drained if $\Delta u = 0$ or undrained if $\Delta u \neq 0$).

During Long-term analysis, the live load surcharge (see Chapter 8) and the dead load induced by the existing pavement section and any asphalt overlays (see Chapter 8 for asphalt unit weight) should be included. The thickness of the overlay shall be based on a 20-year repaving cycle (i.e., 4 repaving cycles in an embankment life of 100 years). The total thickness of the asphalt overlay shall be a minimum of 8 inches (i.e., 2 inches of overlay for each repaving cycle). Similarly to the End-of-Construction loading condition, it is typical to assume that the live load is 250 psf. The load factor (γ_i) shall be 1.0.

17.4.3 Seismic (EE I) Event Condition

According to Duncan, Wright and Brandon (2014), the stability of embankments is affected by earthquakes in 2 ways; first the earthquake subjects the soils to cyclically varying loads and secondly, cyclic strains induced by these loads may lead to a reduction in the shear strength of the soil. The soil response during cyclic loading is undrained (i.e., $\Delta u \neq 0$), since the load is applied rapidly and excess pore pressures do not have time to dissipate. In soils where the shear strength reduction is less than 15 percent, a pseudo-static analysis is normally conducted. If the soil shear strength is reduced more than 15 percent, then a dynamic analysis should be performed. However, due to the complexity of performing dynamic analysis, the pseudo-static analysis may be performed for soils with shear strength reductions greater than 15 percent. If a dynamic analysis is warranted by the GEOR, contact the OES/GDS to explain the reasoning for a dynamic analysis and how the dynamic analysis will be performed. See Chapter 7 for aid in determining the reduced shear strengths that should be used. The seismic event condition is discussed in greater detail in Chapter 13.

In the EE I limit state check stability analysis, include the dead load induced by the addition of asphalt to the pavement section, but do not include the live load surcharges.

17.4.4 Vertically Staged Construction Condition

If very soft to soft soils are located within the subgrade beneath an embankment, vertical stage construction may be required. Vertical stage construction consists of placement of a portion of the total embankment height and allowing settlement to occur. It is during the process of settlement that soil shear strength increases. A more detailed design procedure is provided in later Sections.

17.4.5 Rapid Drawdown Condition

The Rapid Drawdown Condition occurs when an embankment (i.e., a dam) that is used to retain water experiences a rapid (sudden) lowering of the water level and the internal pore pressures in the embankment cannot reduce fast enough creating unbalanced forces along the outer face of the embankment. These unbalanced forces may lead to slope instability because the internal pore pressures are “pushing” on the outer surface of the embankment. For SCDOT projects, this is not a normal condition since SCDOT embankments are typically not designed to retain water. However, in some situations water may build up against an embankment. Where this occurs Rapid Drawdown should be considered. For procedures on how to conduct rapid drawdown analysis, see Duncan, Wright and Brandon (2014).

17.4.6 Surcharge Loading Condition

Surcharge loads can be either temporary or permanent. Temporary surcharge loads can include construction equipment or additional fill materials placed on an embankment to increase the rate of settlement. Temporary soil surcharges are typically used in conjunction with staged constructed embankments. Therefore, the effects of the surcharge will need to be accounted for in staged construction. Typically, for temporary surcharges like equipment, the undrained shear strength of the soil should be used. Permanent surcharges consist of asphalt overlays and live load surcharges caused by traffic, the use of these surcharges has been discussed previously.

17.4.7 Partial Submergence Condition

The partial submergence condition occurs when an embankment experiences the flood stage of a river or stream. When these conditions occur, water can penetrate the embankment and affect the shear strength of the soil. The amount of water that actually penetrates the embankment is a function of the permeability of the material used in the construction of the embankment. The permeability of the embankment material or retained backfill can be estimated as indicated in Chapter 7. Further, the duration of the flood event will also determine the effect of the flood on the embankment. The longer the flood lasts, the more the potential effect on the embankment.

17.5 SLOPE STABILITY ANALYSIS

Stability analysis is based on the concept of limit equilibrium (see Equation 17-1). The Driving Forces include the weight of the soil wedge (i.e., dead load), any live load surcharges and any other external loads (i.e., impact loads on ERSs). The Resisting Force is composed entirely of the shearing resistance of the soil. Limit equilibrium is defined as the state where the resisting force is just larger than the driving force (i.e., $SF = 1.01$ or $\phi = 0.99$). According to Duncan, Wright and Brandon (2014), the equilibrium can be determined for either “single free body or for individual vertical slices.” Regardless of how equilibrium is determined, 3 static equilibrium conditions must be satisfied.

- Moment equilibrium
- Vertical equilibrium
- Horizontal equilibrium

Not all methods resolve all of the equilibrium conditions; some just resolve 1 condition while others solve 2 conditions and assume the third condition is 0.0. Other methods solve all 3 equilibrium conditions.

The single free body looks at the driving forces and the resisting forces along an assumed failure surface. These solutions tend to be relatively simple and are more conducive to the use of design charts. The second method of solving equilibrium is dividing the slope into individual vertical slices. There are numerous procedures that resolve equilibrium using vertical slices. Listed below are some of the more common methods.

- Ordinary Method of Slices
- Simplified (Modified) Bishop
- Force Equilibrium
- Spencer
- Morgenstern and Price

The Ordinary Method of Slices and Simplified Bishop methods assume a circular failure surface. The Spencer and Morgenstern and Price methods both provide a solution for all 3 equilibrium conditions. In addition, both Spencer and Morgenstern and Price can assume a circular as well as non-circular failure surface. The vast majority of slope stability software packages are capable of using more than 1 method to determine the stability of an embankment, and changing the method will affect the resistance factor ($\phi = 1/SF$). Therefore, SCDOT has elected to select a single analysis method, Spencer’s method, for determining stability. Spencer’s method uses not

only both circular and non-circular failure (i.e., sliding block) surfaces but also solves all 3 equilibrium equations. In addition, this method may be used in determining seismic stability/instability. The use of Factor of Safety recognizes the fact that virtually all software currently in use to determine the stability of slopes utilizes Allowable Strength Design (ASD) as opposed to LRFD. The following Subsections provide a brief discussion of all of the slope stability analysis methods listed above. The inclusion of other methods beside Spencer is for completeness of the discussion as well as to partially present SCDOT's reason for selecting the Spencer method.

The use of computer generated solutions for slope stability is required for both preliminary as well as final design. The GEOR should discuss with the OES/GDS the number and location of slope stability analyses for preliminary design. At a minimum perform End-of-Construction, Long-term and Seismic Event conditions for preliminary design. The Seismic Event condition should include the preliminary SSL results.

17.5.1 Ordinary Method of Slices

The Ordinary Method of Slices (OMS) is one of the earliest methods for determining the stability of a slope and was developed by Fellenius in 1936. This method solves moment equilibrium conditions only and is applicable only to circular failure surfaces. This method does not solve either vertical or horizontal equilibrium conditions. This method is relatively simplistic and can be solved by hand easily. This method should not be used during final design. Its inclusion here is for completeness of the various slope stability methods.

17.5.2 Simplified Bishop

The Simplified Bishop method was developed by Bishop in 1955 and can also be called the Modified Bishop method. The Simplified Bishop method solves 2 of the equilibrium equations, moment and vertical. This method assumes that horizontal forces are not only perpendicular to the vertical sides of the slice, but are equal and opposite; therefore, the horizontal forces cancel out. Since horizontal equilibrium is not satisfied, the use of the Simplified Bishop method in pseudo-static seismic design is questionable and should therefore not be used. As with the OMS, Simplified Bishop can only be used on circular failure surfaces.

17.5.3 Force Equilibrium

For the Force Equilibrium method of determining slope stability, depending on the method selected (Lowe and Karafiath (1959); Simplified Janbu (1973); Modified Swedish (1970)), moment equilibrium is either ignored or assumed to be 0.0. Duncan, Wright and Brandon (2014) and the Department of Defense (DOD) [US Army Corps of Engineers (2003)] contain a detailed description of each of these Force Equilibrium methods. The Force Equilibrium method solves both the horizontal and vertical forces. The main assumption required using this method is the inclination of the horizontal forces on the given slice. The inclination of the horizontal forces acting on slice may be either the slope angle or the average slope angle if multiple slopes are involved (i.e., a broken back slope). In addition, the Force Equilibrium methods solve non-circular failure surfaces and therefore, may be solved graphically.

17.5.4 Spencer's Method

Spencer's Method (Spencer (1967)) solves all 3 conditions of equilibrium and is therefore termed a complete limit equilibrium method. Spencer's Method was originally developed to determine the stability of circular failure surfaces; however, Wright (1969) determined that the Spencer Method could also be used on non-circular failure surfaces as well. This method assumes that the interslice forces are parallel and act on an angle (θ) above the horizontal. This angle is one of the unknowns in this method. Therefore, a first approximation of the angle should be the slope angle. The other unknown is the Factor of Safety. Because the method solves for Factor of Safety, an iterative process is required; therefore, this method lends well to the use of computers.

17.5.5 Morgenstern and Price Method

The Morgenstern and Price Method is very similar to the Spencer Method. The main difference between the 2 methods is that Spencer solves for the interslice angle, while the Morgenstern and Price Method solves for the scaling parameter that is used on a function that describes the slice boundary conditions. The Morgenstern and Price Method provides added flexibility using the interslice angle assumptions.

17.6 SETTLEMENT – GENERAL

Regardless of the type of structure, embankments, ERSs, bridges or buildings are all placed on geomaterials (i.e., soil and rock) and will therefore potentially undergo settlement. According to Collin, Leshchinsky, and Hung (2005), settlement is comprised of 3 components: immediate (elastic or instantaneous), primary consolidation and secondary compression. Settlements (strains) are caused by an increase in the overburden stress (i.e., increase in load or demand). In many cases, the amount of settlement (strain) determines the capacity (resistance) to a load (demand).

$$\Delta_v = S_t = S_i + S_c + S_s \quad \text{Equation 17-8}$$

Where,

$S_t = \Delta_v =$ Total Settlement

$S_i =$ Immediate Settlement

$S_c =$ Primary Consolidation Settlement

$S_s =$ Secondary Compression Settlement

Immediate settlement (S_i) is typically built out during construction; however, this amount of settlement shall be reported since it can affect the quantity of borrow required. The total settlement (post construction, i.e., after paving) shall be reported as the amount of primary consolidation (S_c) and secondary compression (S_s) settlement for use in comparing to the Performance Limits established in Chapter 10. Additionally, in determining the total amount of settlement that geomaterials will undergo, the time for the settlement shall also be determined. It is anticipated that immediate settlement will occur over a period of days to months, while primary consolidation and secondary compression settlement will typically occur over months to years. Another phenomenon that occurs in very soft fine-grained soils is lateral squeeze. Lateral squeeze can cause both vertical as well as lateral displacements. These displacements may induce loadings on structures that have foundations located in the layer susceptible to squeeze.

17.7 CHANGE IN STRESS

As indicated previously, in order for settlement to occur there must be an increase in stress placed on the geomaterials, especially in the case of soil. The increase in stress can be caused by placement of an embankment, shallow or deep foundation or dewatering. The effects of dewatering will not be described in this Manual; however, should dewatering be required, an expert in dewatering shall be consulted. There are various methods for determining the change in stress at different depths within the soil profile. The method used in this Manual is the Boussinesq method. Discussed below is the change in stress caused by shallow foundations and by the placement of an embankment. In addition, the increased stress on buried structures caused by the placement of fill is also discussed.

17.7.1 Shallow Foundations

Shallow foundations, as indicated in Chapter 15, are used to support bridges, ERSs and other ancillary transportation facilities. Earthen embankments are theoretically supported by shallow foundations; however, the change in stress caused by embankments is discussed in the following Section. According to Chapter 15, a square spread footing has a length to width (L_f/B_f) ratio of less than 5. Shallow foundations having a length to width ratio greater than 5 are termed strip or continuous footings. Figure 17-9 depicts the approximate distribution of stresses beneath square and continuous footings.

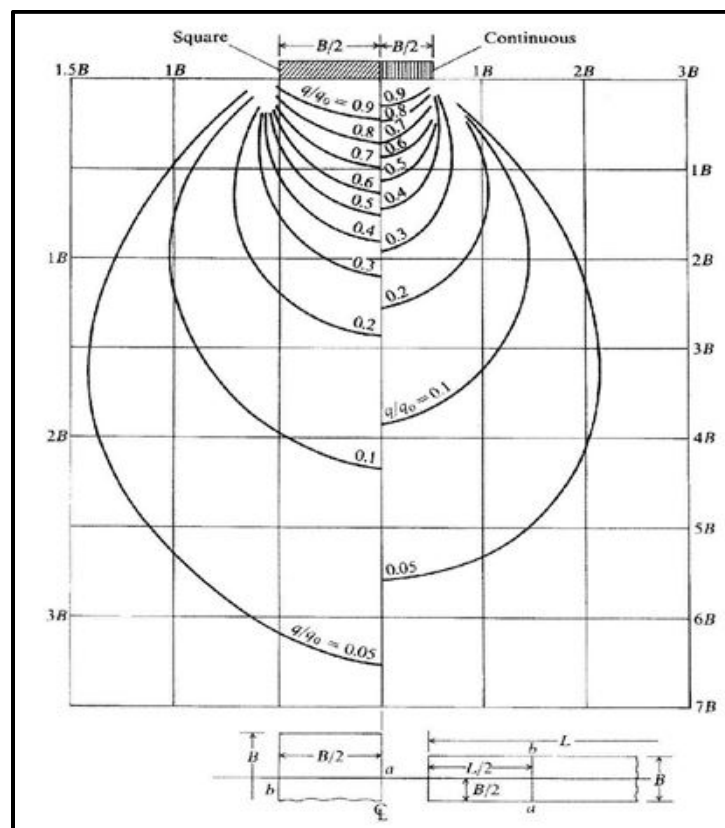

Figure 17-9, Stress Isobars
(Bowles (1986))

Where,

- B = Foundation width
- L = Foundation length
- q = Stress at depth indicated
- q_o = Applied vertical stress

Figure 17-9 should only be used as an approximate estimate of the increase in stress on a soil layer. To more accurately determine the increase in stress caused by a shallow foundation, the following equation should be used.

$$\Delta\sigma_v = \int_0^r \left[\left(\frac{3q_o}{2\pi Z^2} \right) * \left\{ \frac{1}{\left[1 + \left(\frac{r}{Z} \right)^2 \right]^{\frac{5}{2}}} \right\} * 2\pi dr \right] \quad \text{Equation 17-9}$$

Where,

- q_o = Applied vertical stress
- Z = Vertical depth below load
- r = Horizontal distance between the load application and the point where the vertical pressure is being determined

Newmark (1935) performed the integration of this equation and derived an equation for the increase in vertical stress beneath a corner of a uniformly loaded area.

$$\Delta\sigma_v = I * q_o \quad \text{Equation 17-10}$$

Where,

- I = Influence factor which depends on m and n
- m = x/z
- n = y/z
- x = Width of the loaded area
- y = Length of loaded area
- z = Depth below the loaded surface to the point of interest
- q_o = Applied vertical stress

The influence factor, I, can be obtained from Figure 17-10.

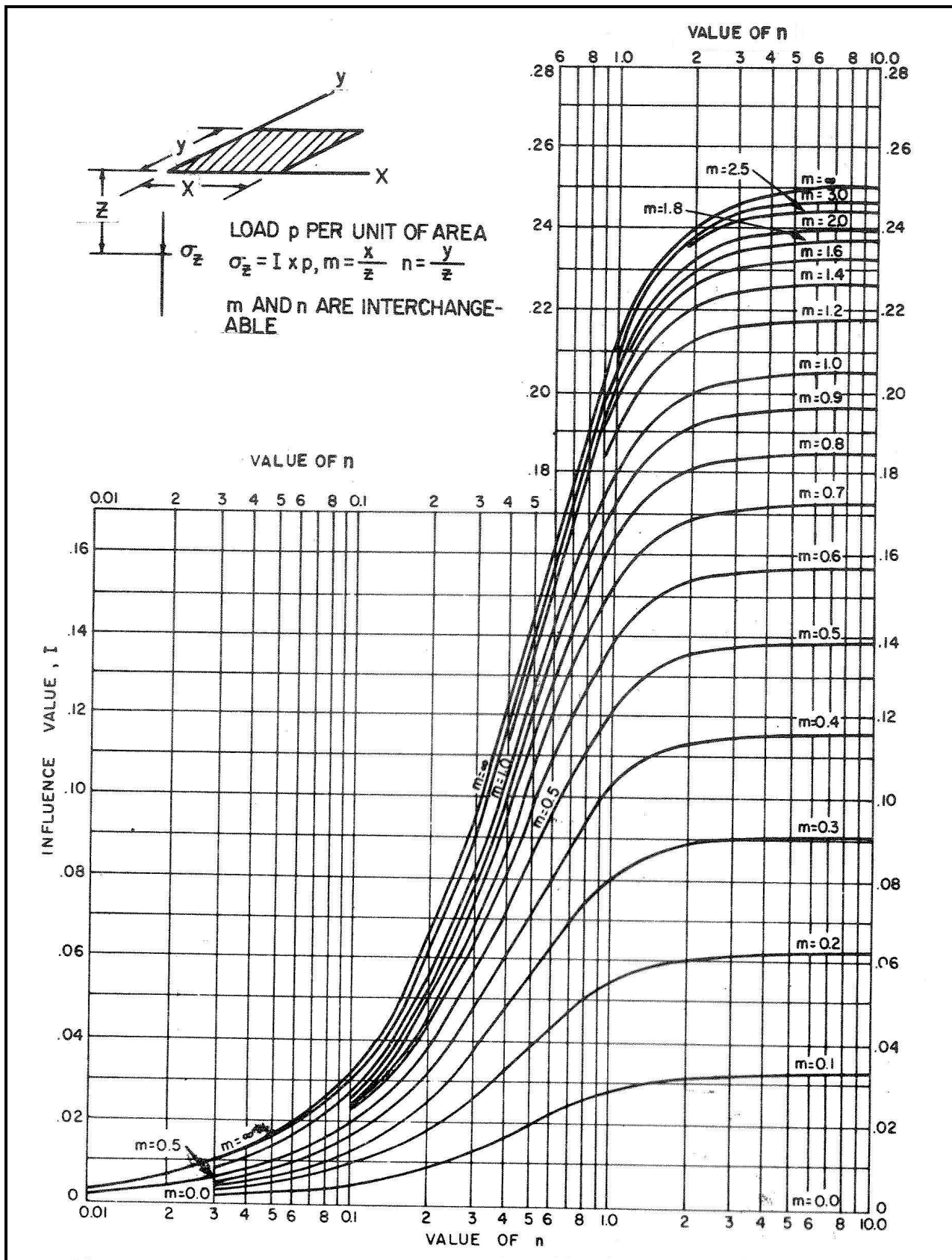
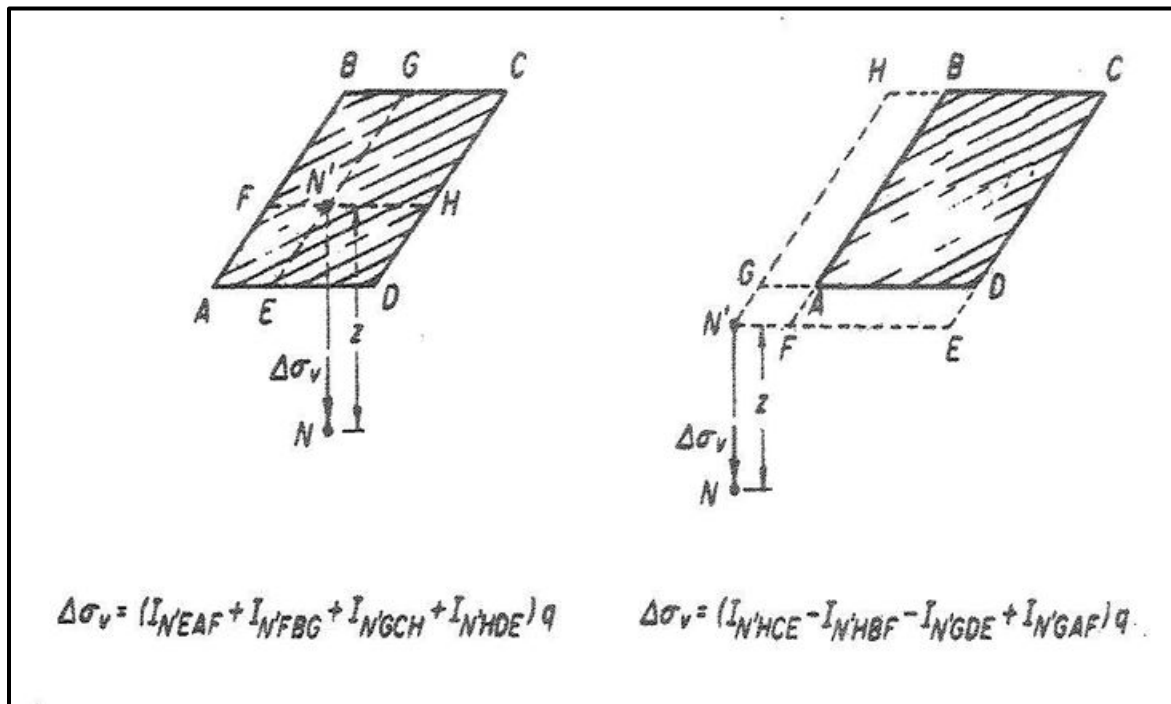

Figure 17-10, Influence Factor Chart (DOD (NAVFAC DM 7.1) (1982))

The change in stress determined using Equation 17-10 is for a point underneath the corner of a loaded area. Therefore, the change in stress at a depth underneath the center of the footing is 4 times the amount determined from Equation 17-10. The change in stress at the mid-point of an edge of a footing is twice the amount determined from Equation 17-10. To find the change in stress at points other than the middle, middle of the edge or a corner of a footing, the Principle of Superposition is used. The Principle of Superposition states that the change in stress at any point is sum of the stresses of the corners over the point (see Figure 17-11).



**Figure 17-11, Principle of Superposition
(Collins, Leshchinsky, and Hung (2005))**

17.7.2 Embankments

The change in stress beneath embankments is determined differently than for shallow foundations, because the area loaded by an embankment is larger than for a shallow foundation. Further the change in stress beneath an embankment is complicated by the geometry of the embankment, i.e., the sides slope downward. Embankments comprise 2 groups; those with infinite length (i.e., side slopes) and those with finite length (i.e., end slopes). The first group is generally longitudinal to the direction of travel, while the other is generally transverse to the direction of travel. For infinite slope embankments, the loading can be represented as a trapezoid. The change in stress beneath an embankment is determined using Equation 17-10. Osterberg (1957) integrated the Boussinesq equations to develop the influence factors (I). Figure 17-12 provides the chart for determining the influence factors (I) for use in Equation 17-10.

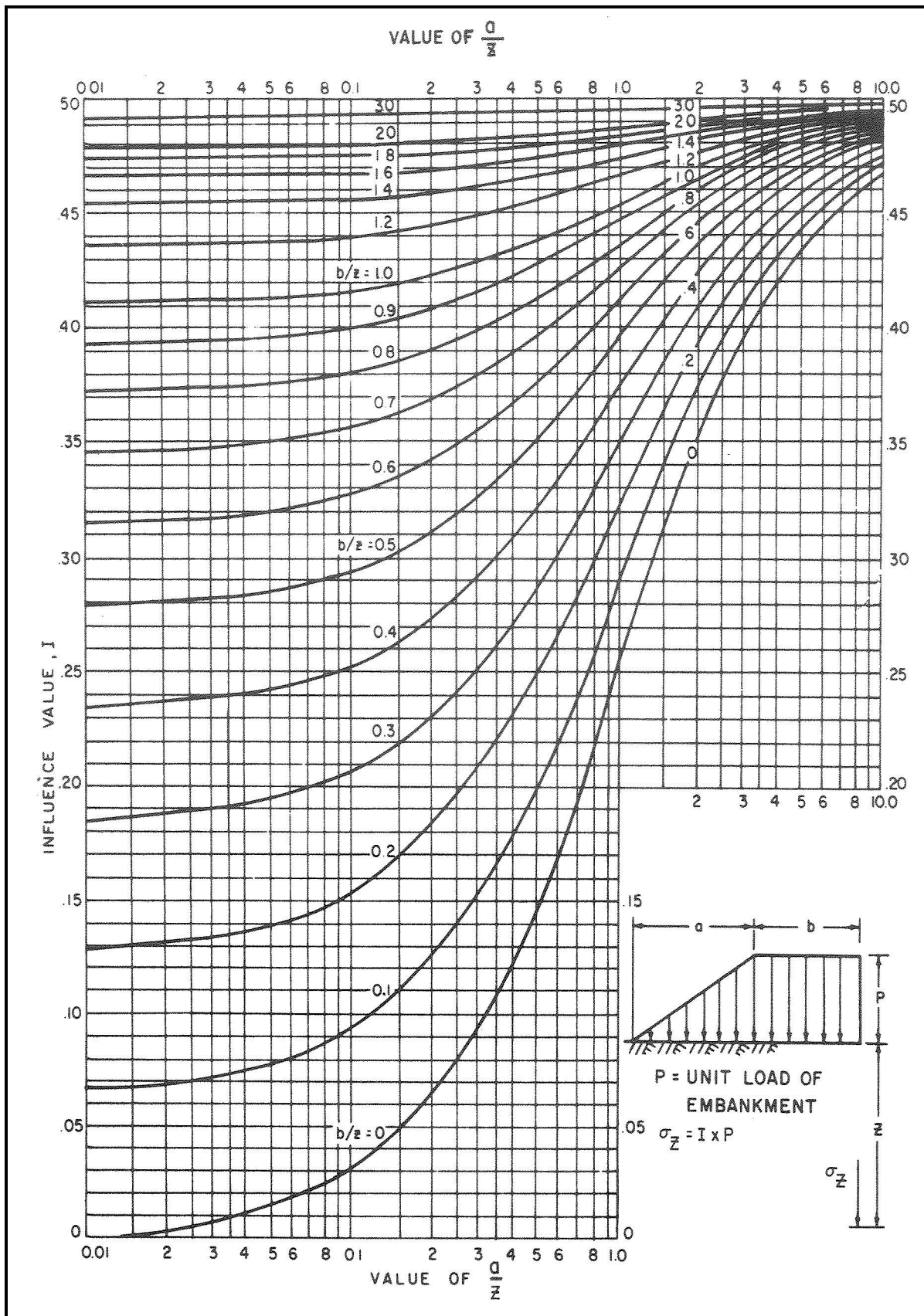

Figure 17-12, Influence Factor Chart – Infinitely Long Embankments (DOD (NAVFAC DM 7.1) (1982))

For finite slopes, Equation 17-10 is used to determine the change in stress. However, the development of the influence factor (I) is complicated by the geometric requirements of the slope. The loading consists of 2 components; first the areal load of the embankment and second the load of the sloping section. The influence factor for the area load is determined using Figure 17-10. Note that the stress is doubled, because the stress is determined at a corner of the loaded area. The influence factor for the sloping portion is determined from Figures 17-13 and 17-14.

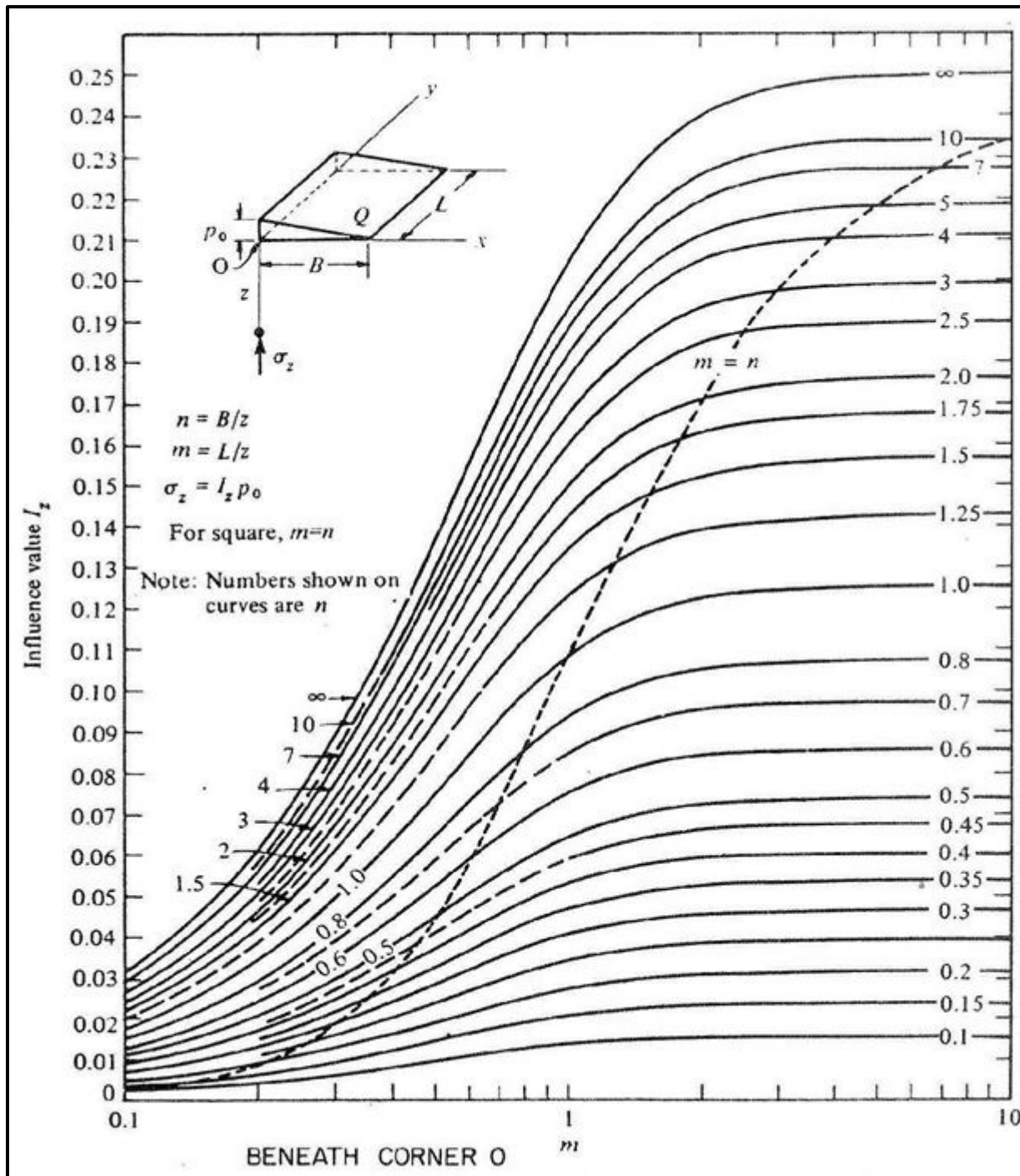

Figure 17-13, Influence Chart Beneath Crest of Slope (DOD (NAVFAC DM 7.1) (1982))

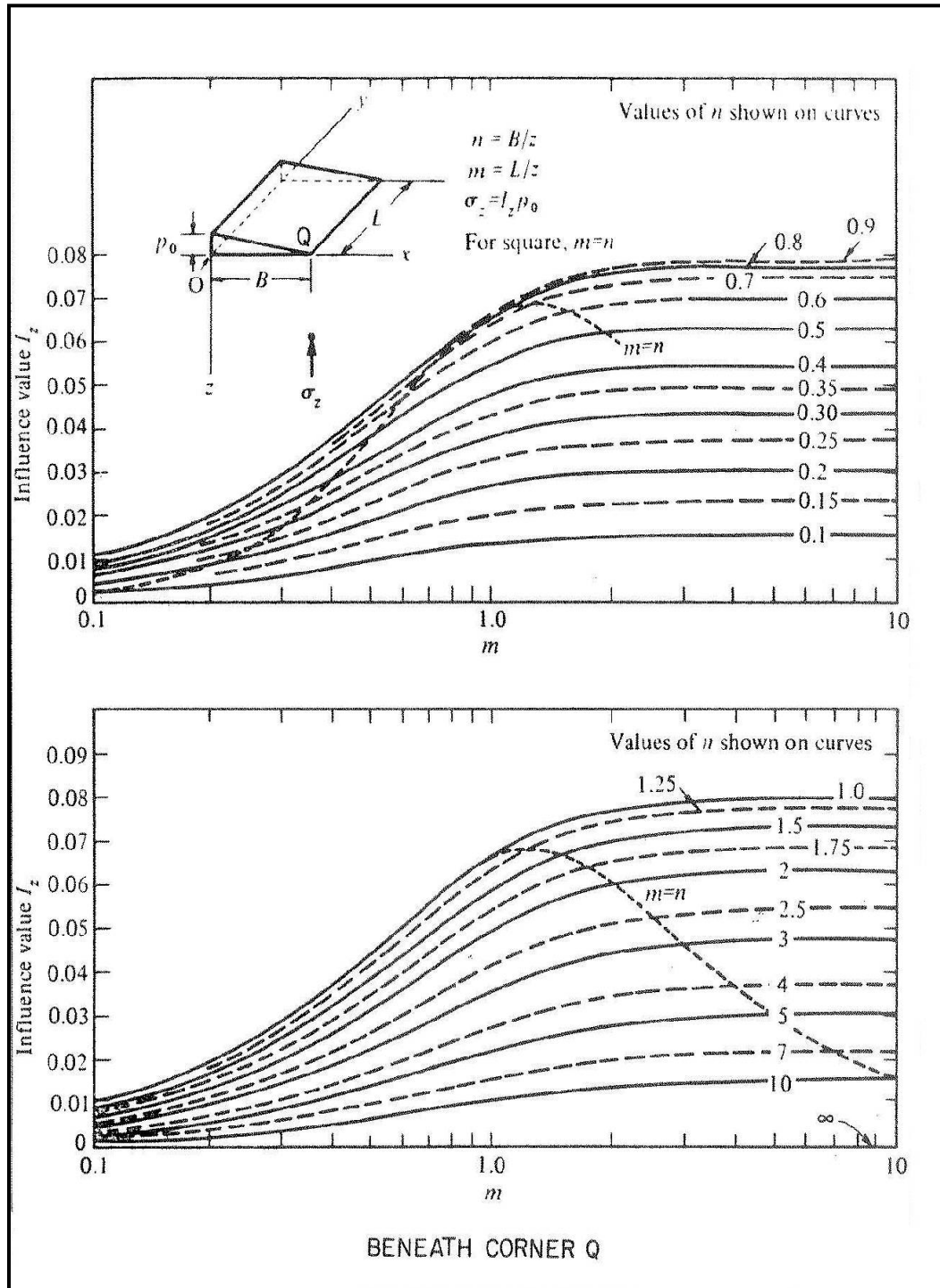

Figure 17-14, Influence Chart Beneath Toe of Slope (DOD (NAVFAC DM 7.1) (1982))

An alternate to the procedures indicated above for finding the change in stress beneath a sloped embankment, the procedure described in the Samtani and Nowatzki (2006) may be used. This method was originally developed by the New York State Department of Transportation. This method uses the following equation.

$$\rho = K * \gamma_f * h$$

Equation 17-11

Where,

ρ = Change in vertical stress caused by the embankment ($\Delta\sigma_v$)

K = Influence factor from Figure 17-15

γ_f = Unit Weight of fill Material

h = Height of embankment (see Figure 17-15)

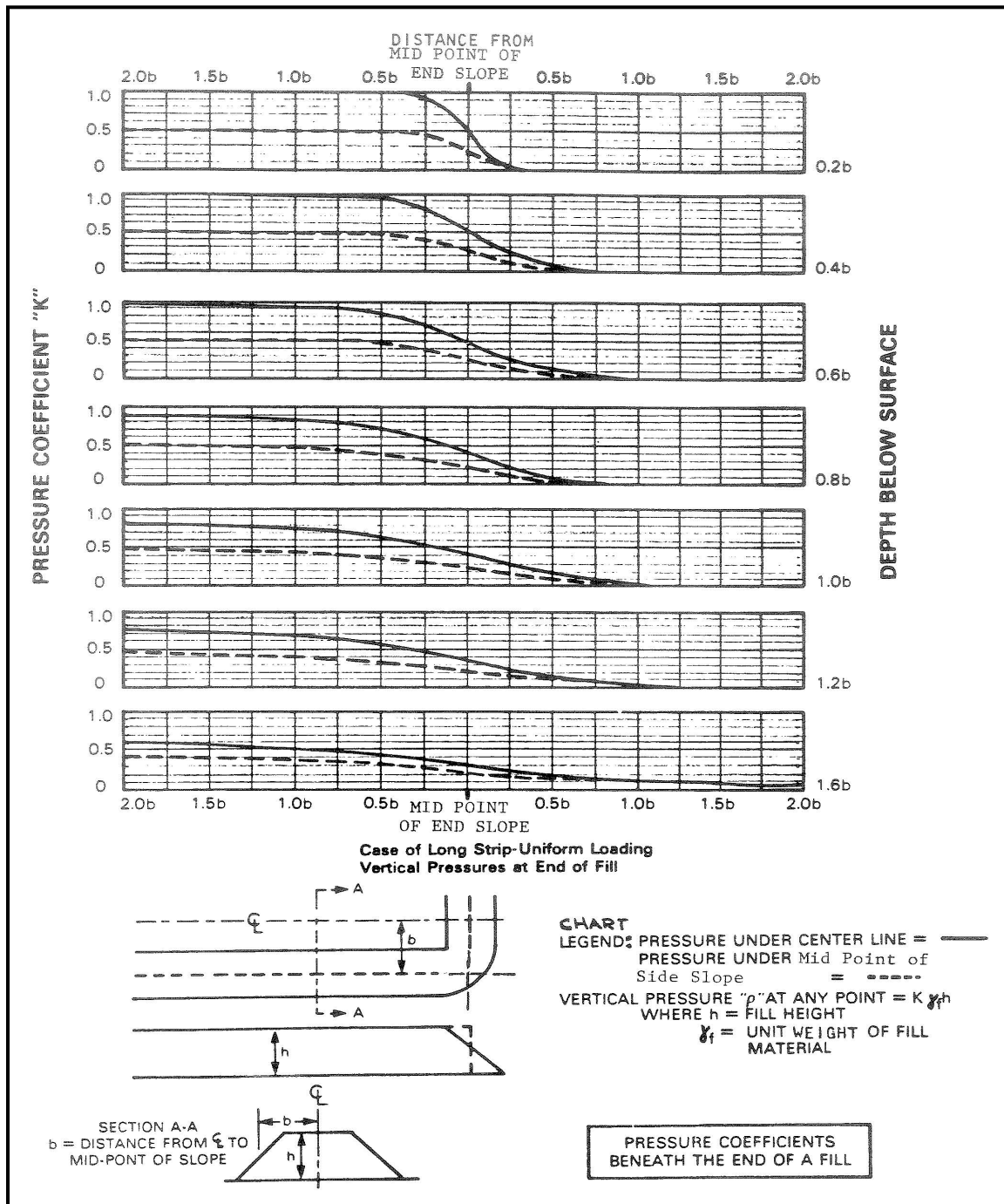

Figure 17-15, Pressure Coefficients Beneath the End of a Fill (Samtani and Nowatzki (2006))

17.7.3 Buried Structures

Buried structures consist of culverts, pipes, boxes, etc. and are required to be designed to handle the loads imposed by embankments. The structural design of these structures is beyond the scope of this Manual; however, the design of buried structures is handled in AASHTO LRFD Specifications (Section 12 – Buried Structures and Tunnel Liners). These structures shall be designed to handle horizontal and vertical earth pressures, pavement dead load, live load and vehicular dynamic loads. In addition, these structures may be required to accommodate earth and live load surcharges, downdrag loads, external hydrostatic pressure and buoyancy effects. These last 2 loads are caused by the structure being placed below the water table. Please note that any structure placed below the water table will require additional construction effort. It should be anticipated that dewatering will be required and that an expert in dewatering shall be retained by the Contractor during construction. Because most of these structures are placed within or below embankments, the GEOR shall determine the settlement of the structure, required only for pipes, boxes and culverts with an ADT $\geq 5,000$ vehicles per day (vpd) and having a diameter or an inside cross-sectional dimension greater than or equal to 48 inches, as required in Chapter 10 and will report the results to both the SEOR and HEOR who will determine the impact of the settlement to the performance of the structure.

17.8 IMMEDIATE SETTLEMENT

Immediate settlement (S_i), also termed elastic or instantaneous, occurs upon initial loading of the subgrade soils. This type of settlement occurs in both Sand-Like and Clay-Like soils. The amount of settlement is based on elastic compression of the soils and the time for settlement to occur typically ranges from days to months (1 to 3) or typically during construction. The settlement consists of the compression of air filled voids (Clay-Like soils) and the rearrangement of soil particles (Sand-Like soils). This settlement is anticipated to comprise EV-01A or RV-01A (see Chapter 10) depending on whether the embankment contains an ERS or not. As indicated in Chapter 10 the results of the S_i determination shall be reported; since this settlement can affect the amount of borrow material required for a project.

17.8.1 Sand-Like Soils

Sand-Like soils as defined in Chapter 7 consist of sands, gravels, low plasticity silts and residual soils. In Sand-Like soils, the S_i (elastic) typically comprises the total amount of settlement anticipated. This Section provides several different methods for determining the S_i of Sand-Like soils. All of the methods should be used and the largest settlement shall be used to compare to the performance limits provided in Chapter 10. The methods are based on the SPT, on the CPTu and on the DMT.

17.8.1.1 SPT Method

There are three SPT methods for determining immediate settlement of Sand-Like soils. The first method is the Hough (1959) method and is used in AASHTO LRFD Specifications (Section 10.6 – Spread Footings). The amount of S_i is determined using the following equation.

Equation 17-12

$$S_i = \sum_{i=1}^n \left(\frac{1}{C'} \right) * H_i * \left[\log \left(\frac{\sigma'_{vo} + \Delta\sigma'_v}{\sigma'_{vo}} \right) \right]$$

Where,

C' = Bearing Capacity Index (from Figure 17 -16)

H_i = Thickness of the i^{th} layer

σ'_{vo} = Effective overburden pressure at the mid-point of i^{th} layer

$\Delta\sigma'_v$ = Change in effective vertical stress at the mid-point of i^{th} layer

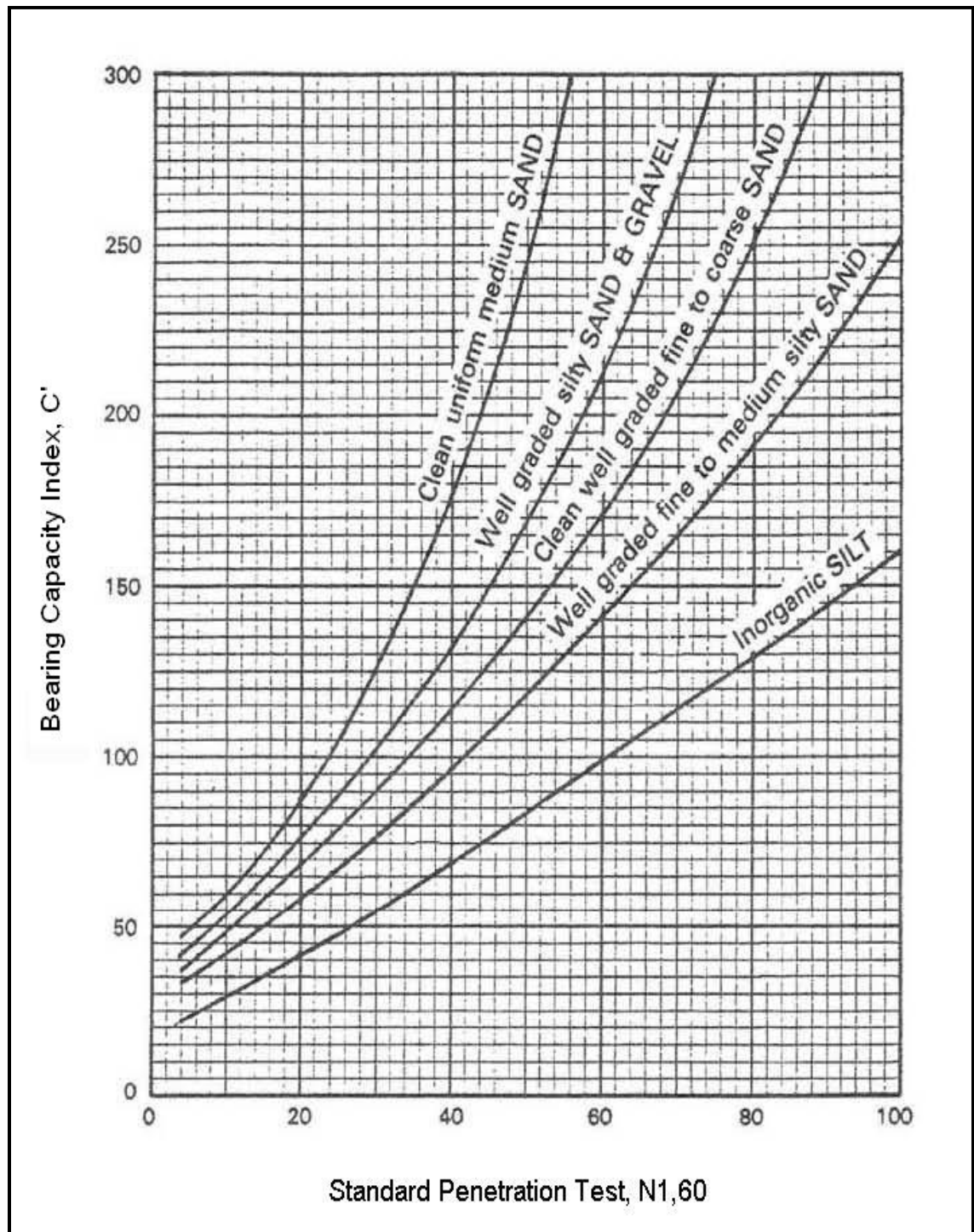

Figure 17-16, Bearing Capacity Index Chart (Collin, Leshchinsky, and Hung (2005), Modified from Hough (1959))

The $N_{1,60}$ is determined using the methodology discussed in Chapter 7.

The second SPT method of determining elastic settlement is the Peck and Bazaraa Method (Munfakh, Arman, Collin, Hung, and Brouillette (2001)). This method is a modification of the

method described by Terzaghi and Peck (1967). It should be noted the equation used to determine the settlement is in SI units. The Peck and Bazaraa Method equation is listed below.

$$S_i = 0.265 * C_W * C_D * \left[\left(\frac{2q_o}{(N_{1,60})_{ave}} \right) * \left(\frac{2B_f}{B_f + 0.3} \right)^2 \right] \quad \text{Equation 17-13}$$

$$C_W = \frac{\sigma_{vo}}{\sigma'_{vo}} \quad \text{Equation 17-14}$$

$$C_D = 1 - 0.4 * \sqrt{\frac{\gamma * D_f}{q_o}} \quad \text{Equation 17-15}$$

Where,

S_i = Immediate settlement, millimeters (mm) [1 mm = 0.03937 in]

C_W = Water table correction factor, at a depth of 1/2 of B_f

C_D = Embedment correction factor, use 1.0 when filling above original grade

B_f = Footing width, meters (m) [1 m = 3.28084 ft]

D_f = Depth of footing base embedment from ground surface, meters

γ = Total unit weight of soil, kiloNewtons per cubic meter (kN/m^3)
[1 kN/m^3 = 6.3656 lbs/ft^3]

q_o = Applied vertical stress or bearing pressure, kiloPascals (kPa) [1 kPa = 0.0209 ksf]

σ_{vo} = Total overburden pressure

σ'_{vo} = Effective overburden pressure

$(N_{1,60})_{ave}$ = Average $N_{1,60}$ -value from base of footing to a depth of B_f below footing, blows per 0.3 meters

1N = 1*[($\text{kg}\cdot\text{m}$)/ s^2]

1Pa = 1*(N/m^2) = 1*[($\text{kg}/(\text{m}\cdot\text{s}^2)$)]

The third SPT method was developed by Duncan and Buchignani (1976) based on Meyerhof (1965). The immediate settlement equation is provided below.

$$S_i = \frac{5q_o}{(N_{60} - 1.5) * C_B} \quad \text{Equation 17-16}$$

Where,

S_i = Immediate settlement, inches

q_o = Applied vertical stress, tsf

N_{60} = Standard Penetration value corrected only for energy (see Chapter 7)

C_B = Width Correction (see Table 17-2)

The N_{60} -value is an average value from the base of the footing to a depth of B_f .

**Table 17-2, Width Correction Factor, C_B
(Duncan and Buchignani (1976))**

Footing Width, B (feet)	C_B
≤ 4	1.00
6	0.95
8	0.90
10	0.85
≥ 12	0.80

Duncan and Buchignani (1976) indicate that immediate (elastic) settlement will continue to increase over time (i.e., creep). The total amount of elastic settlement over time is determined using the following equation.

$$S_{iet} = S_i * C_t \quad \text{Equation 17-17}$$

Where

- S_{iet} = Elastic settlement after a period of time
- S_i = Immediate or elastic settlement
- C_t = Time rate factor (see Table 17-3)

**Table 17-3, Time Rate Factors
(Duncan and Buchignani (1976))**

Time	C_t
1 month	1.0
4 months	1.1
1 year	1.2
3 years	1.3
10 years	1.4
30 years	1.5

For times other than those depicted in Table 17-3, the following equation may be used.

$$C_t = [0.0858 * \ln(t)] + 0.9907 \quad \text{Equation 17-18}$$

Where,

- C_t = Time rate factor
- t = Time period over which settlement occurs, months

17.8.1.2 CPT Method

There is one CPT method available for determining the immediate settlement of Sand-Like soils. It was developed by Schmertmann (1970) and is applicable only to shallow foundations (i.e., a rigid structure is required). Similarly to the Peck and Bazaraa Method, the Schmertmann Method uses SI units. The Schmertmann Method uses the following equations.

$$S_i = C_D * C_t * q_{net} * \left[\sum_{i=1}^n \left(\frac{H_i}{E_{si}} \right) * I_{azi} \right] \quad \text{Equation 17-19}$$

$$C_D = 1 - 0.5 \left(\frac{\sigma'_D}{q_{net}} \right) \geq 0.5 \quad \text{Equation 17-20}$$

$$C_t = 1 + 0.2 \left[\log \left(\frac{t}{0.1} \right) \right] \quad \text{Equation 17-21}$$

$$q_{net} = q_o - \sigma'_D \quad \text{Equation 17-22}$$

$$I_p = 0.5 + 0.1 * \sqrt{\frac{q_{net}}{\sigma'_{lp}}} \quad \text{Equation 17-23}$$

Where,

C_D = Depth correction factor

C_t = Creep correction factor ($t > 0.1$ years)

q_{net} = Net total average bearing pressure, kPa

H_i = Thickness of the i^{th} layer, meters

E_{si} = Modulus of Elasticity of the i^{th} layer, kPa

I_{azi} = Average vertical strain influence factor of the i^{th} layer (from Figure 17-17)

q_o = Applied bearing pressure, kPa

σ'_D = Vertical effective stress at the base of the footing, kPa

t = Time, years

I_p = Peak influence factor value

σ'_{lp} = Vertical effective stress at the depth of the peak influence factor (I_p), kPa

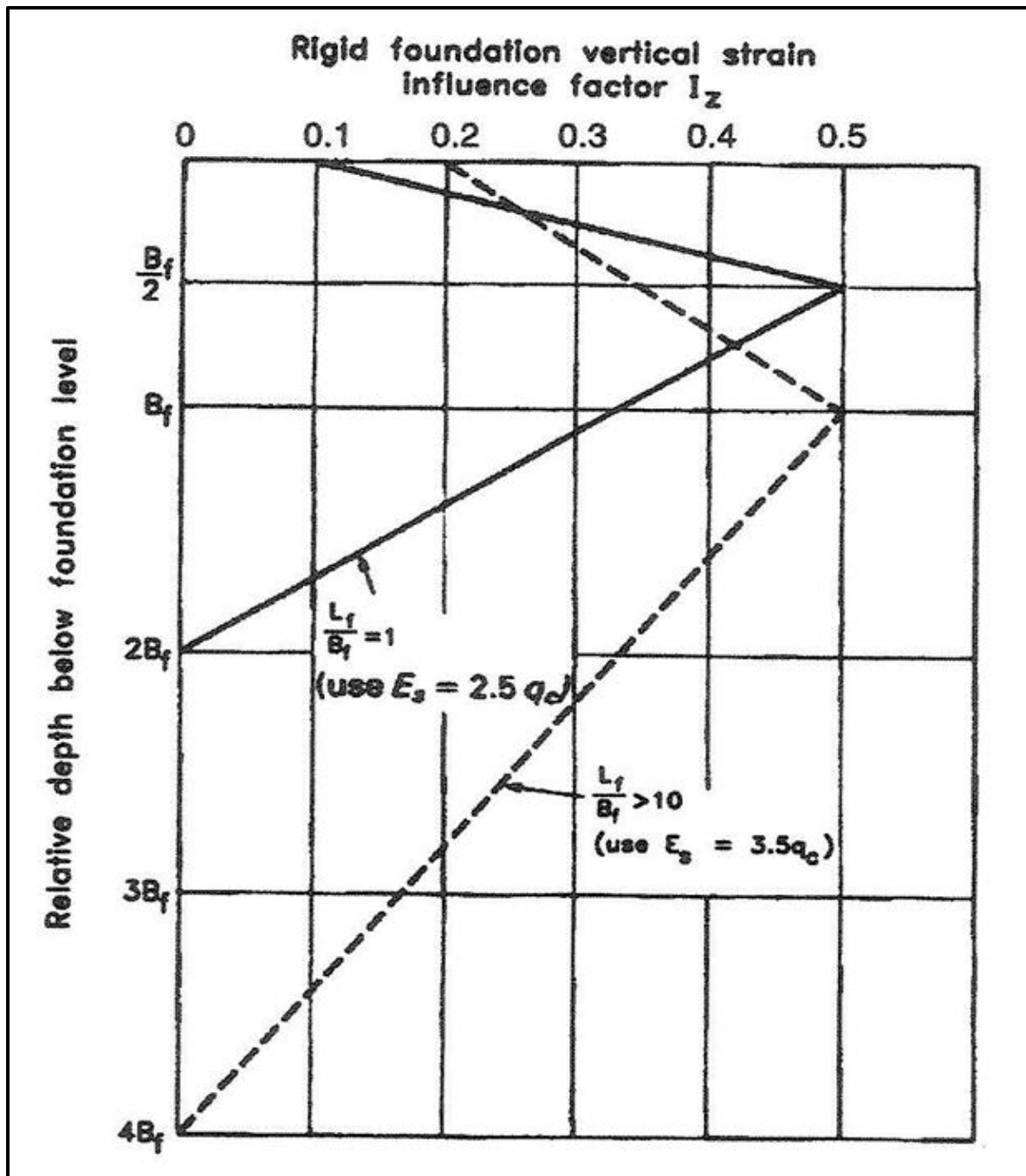

Figure 17-17, Vertical Strain Influence Factor Chart (Munfakh, et al. (2001))

The Modulus of Elasticity (E_s) can be developed directly from laboratory testing, from Chapter 7 or from the following equation. This equation applies only to determining the E_s from CPT data.

$$E_s = F_s * q_c \tag{Equation 17-24}$$

Where,

F_s = Correlation factor depending on cone and soil type, stress level and footing shape (see Table 17-4)

q_c = Uncorrected cone penetration tip resistance, kPa

**Table 17-4, Correlation Factor, F_s
(Munfakh, et al. (2001))**

Case	F_s
$L_f/B_f = 1$	2.5
$L_f/B_f > 10$	3.5

Where,

B_f = Footing width

L_f = Footing length

As an alternate to Figure 17-17, the vertical strain influence factor may be determined using the equations in Table 17-5.

**Table 17-5, Vertical Strain Influence Factor Equations
(Munfakh, et al. (2001))**

Footing Shape	I Terms	H_i	I_{azi} Equations
$L_f/B_f < 1$ (square)	I_{zsq}	0 to $B_f/2$	$0.1 + \left(\frac{H_i}{B_f}\right) * (2I_p - 0.2)$
		$B_f/2$ to $2B_f$	$0.667I_p * \left(2 - \frac{H_i}{B_f}\right)$
$L_f/B_f > 10$ (continuous)	I_{zc}	0 to B_f	$0.2 + \left(\frac{H_i}{B_f}\right) * (I_p - 0.2)$
		B_f to $4B_f$	$0.333I_p * \left(4 - \frac{H_i}{B_f}\right)$
$1 < L_f/B_f < 10$ (rectangular)	I_{zr}	N/A	$I_{zsq} + 0.111(I_{zc} - I_{zsq}) * \left[\left(\frac{L_f}{B_f}\right) - 1\right]$

17.8.1.3 DMT Method

Immediate settlement can be determined from Dilatometer Test data. The method is described in detail by Briaud and Miran (1992). The equation for determining immediate settlement is provided below.

Equation 17-25

$$S_i = \sum_{i=1}^n \left(\frac{\Delta\sigma_v}{M_i}\right) * H_i$$

Where,

$\Delta\sigma_v$ = Change in vertical stress at the mid-point of i^{th} layer

M_i = Averaged constrained modulus of the i^{th} layer

H_i = Thickness of the i^{th} layer

17.8.2 Clay-Like Soils

There is some immediate settlement in Clay-Like (clays and plastic silts) soils with most settlement occurring within a relatively short period after loading is applied. Most of this immediate settlement is from distortion and compression of air filled voids. It is anticipated that very little immediate settlement would occur in saturated Clay-Like soils. However, for unsaturated and/or highly overconsolidated ($OCR \geq 4$) Clay-Like soils, immediate settlement can be a predominant portion of the total settlement (S_i). These immediate settlements can be determined using the Theory of Elasticity (Timoshenko and Goodier (1951)) and are determined using the following equation.

$$S_i = \frac{[q_o * (1 - \nu^2) * \sqrt{A}]}{(E_s * \beta_z)} \quad \text{Equation 17-26}$$

Where,

q_o = Applied bearing pressure at the bottom of loaded area

ν = Poisson's ratio (see Chapter 7)

A = Contact area of the load

E_s = Modulus of elasticity for the soil (see Chapter 7)

β_z = Footing shape and rigidity factor (see Table 17-6)

**Table 17-6, Footing Shape and Rigidity Factors
(Munfakh, et al. (2001))**

L_f/B_f	β_z Flexible	β_z Rigid
1	1.06	1.08
2	1.09	1.10
3	1.13	1.15
5	1.22	1.24
10	1.41	1.41

Where B_f and L_f are the same as in the CPT Method described previously. If L_f/B_f is between 5 and 10, use linear interpretation. For L_f/B_f greater than 10, use the β_z for 1.5. The elastic parameters, Poisson's ratio (ν) and modulus of elasticity (E_s), are provided in Chapter 7 for Clay-Like soils.

Christian and Carrier (1978) developed an improved Janbu approximation for determining immediate settlement in Clay-Like soils. The improved Janbu approximation is provided below and assumes that the Poisson's ratio (ν) of the soil is 0.5.

$$S_i = \mu_0 * \mu_1 * \left(\frac{q_o * B_f}{E_s} \right) \quad \text{Equation 17-27}$$

Where,

μ_0 = Influence factor for depth (see Figure 17-18)

μ_1 = Influence factor for foundation shape (see Figure 17-18)

- q_0 = Applied vertical stress at the bottom of loaded area
 B_f = Foundation width
 L_f = Foundation length
 D = Foundation depth below ground surface
 H = Distance between bottom of foundation and a firm (non-compressible) layer
 E_s = Modulus of elasticity for the soil (see Chapter 7)

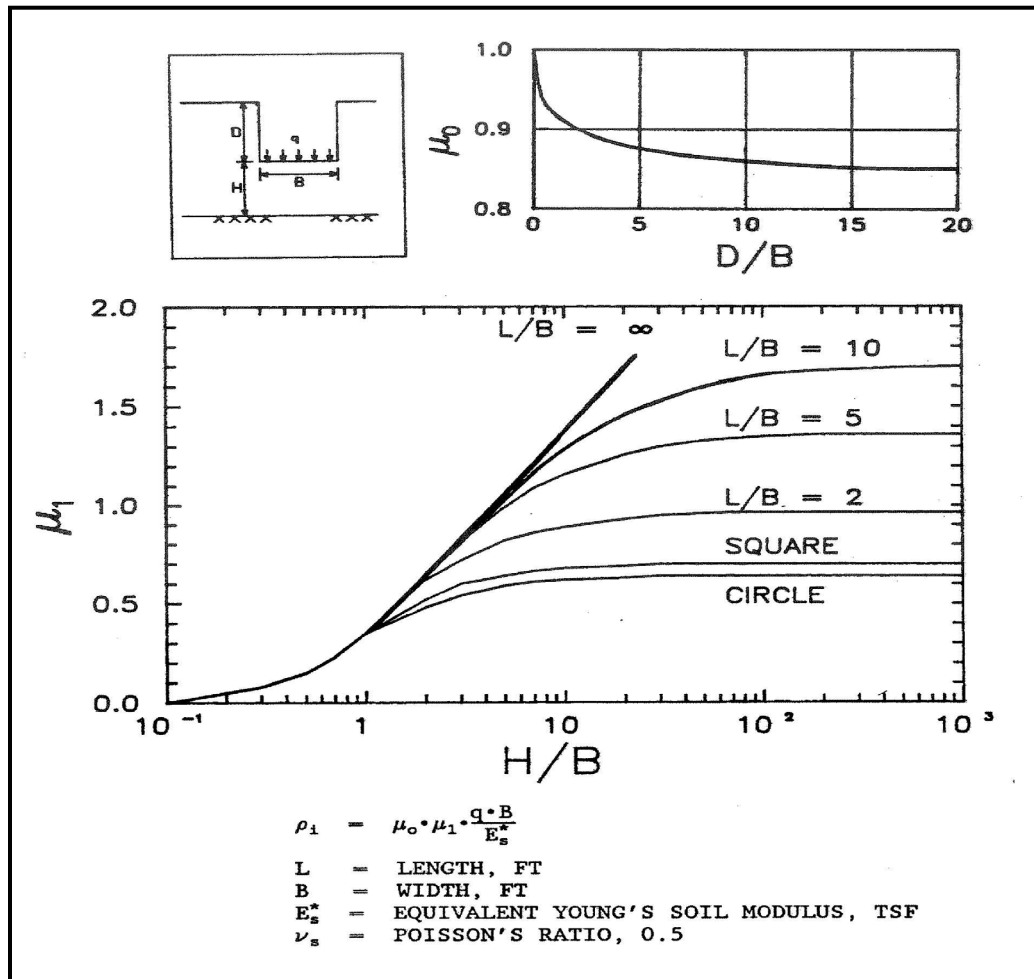

Figure 17-18, Janbu Influence Factor Chart
(DOD (USACE EM 1110-1-1904) (1990))

17.9 PRIMARY CONSOLIDATION SETTLEMENT

Primary consolidation settlement (S_c) occurs when the increase in load on a soil results in the generation of excess pore pressures within the soil voids. Depending on the type of soil, the time to reduce the excess pore pressures to some steady state level may be rapid (Sand-Like soils) or may require long periods of time (Clay-Like soils). Therefore, primary consolidation settlement is comprised of 2 components: the amount of settlement and the time for settlement to occur. The amount of time required for Sand-Like soil to settle is relatively short, typically occurring during construction, and the amount of settlement can be determined using immediate or elastic settlement theory. Therefore, the remainder of this Section will exclusively look at Clay-Like soils. Typically, normally consolidated ($OCR = 1$) soils undergo primary consolidation settlement. For the purpose of this Chapter, all plastic Clay-Like soils that have an OCR of less than 4 shall have

the primary consolidation settlement determined. Primary consolidation is considered to begin at the end of elastic settlement. For Clay-Like soils, elastic settlement should occur relatively quickly and as indicated previously is comprised of the closing of air filled voids. With the completion of elastic settlement it should be assumed that the Clay-Like soils are saturated.

The determination of primary consolidation settlement is based on 6 steps as presented in Table 17-7.

**Table 17-7, Primary Consolidation Settlement Steps
(Modified from Munfakh, et al. (2001))**

Step	Item
1	Computation of the initial vertical effective stress (σ'_{vo}) [total vertical stress (σ_{vo}) and pore water pressure (u_o)] of the layer(s) midpoint
2	Determination of preconsolidation stresses (σ'_p or p'_c)
3	Computation of changes in vertical effective stress ($\Delta\sigma'_v$) [associated with changes in both total stress ($\Delta\sigma_v$) and pore water pressures (Δu)] due to the construction
4	Determination of compressibility of the clay or plastic silt
5	Computation of layer compressions (S_c)
6	Computation of time for compressions

17.9.1 Amount of Settlement

In Clay-Like soils, loads are carried first by the pore water located in the interstitial space between the soil grains and then by the soil grains. The pore water pressure increases proportional to the load applied at that depth. As the excess pore water pressures reduce through drainage, the load is transferred to the soil grains. This drainage causes the settlement of Clay-Like soils. Therefore, the settlement is directly proportional to the volume of water drained from the soil layer. Typically, the area loaded is large, resulting in the flow of water vertically (either up or down) and not horizontally. Therefore, 1-dimensional consolidation theory may be used to determine settlements of Clay-Like soils.

The determination of the amount of settlement is dependent on whether the soil is normally consolidated, overconsolidated or a combination of both. The amount of settlement for under consolidated soils is determined the same as normally consolidated soil. In addition, the way the data is presented, either e -log p or ε -log p curves, will also determine which equation is used. Presented in Table 17-8 are the equations for determining the total primary consolidation settlement (S_c).

Table 17-8, Primary Consolidation Settlement Equations

e-log p		
$\sigma'_{vo} < \sigma'_p$ < σ'_f	$S_c = \sum_{i=1}^n H_o * \left[\left(\frac{C_c}{1 + e_o} \right) * \left(\log \frac{\sigma'_{vo}}{\sigma'_p} \right) + \left(\frac{C_c}{1 + e_o} \right) * \left(\log \frac{\sigma'_f}{\sigma'_{vo}} \right) \right]$	Equation 17-28A
$\sigma'_{vo} = \sigma'_p$ < σ'_f	$S_c = \sum_{i=1}^n H_o * \left(\frac{C_c}{1 + e_o} \right) * \left(\log \frac{\sigma'_f}{\sigma'_{vo}} \right)$	Equation 17-28B
$\sigma'_{vo} < \sigma'_f$ < σ'_p	$S_c = \sum_{i=1}^n H_o * \left(\frac{C_r}{1 + e_o} \right) * \left(\log \frac{\sigma'_f}{\sigma'_{vo}} \right)$	Equation 17-29
$\sigma'_{vo} < \sigma'_p$ < σ'_f	$S_c = \sum_{i=1}^n H_o * \left[\left(\frac{C_r}{1 + e_o} \right) * \left(\log \frac{\sigma'_p}{\sigma'_{vo}} \right) + \left(\frac{C_c}{1 + e_o} \right) * \left(\log \frac{\sigma'_f}{\sigma'_p} \right) \right]$	Equation 17-30
ε-log p		
$\sigma'_{vo} < \sigma'_p$ < σ'_f	$S_c = \sum_{i=1}^n H_o * \left[(C_{\epsilon c}) * \left(\log \frac{\sigma'_{vo}}{\sigma'_p} \right) + (C_{\epsilon c}) * \left(\log \frac{\sigma'_f}{\sigma'_{vo}} \right) \right]$	Equation 17-31A
$\sigma'_{vo} = \sigma'_p$ < σ'_f	$S_c = \sum_{i=1}^n H_o * (C_{\epsilon c}) * \left(\log \frac{\sigma'_f}{\sigma'_{vo}} \right)$	Equation 17-31B
$\sigma'_{vo} < \sigma'_f$ < σ'_p	$S_c = \sum_{i=1}^n H_o * (C_{\epsilon r}) * \left(\log \frac{\sigma'_f}{\sigma'_{vo}} \right)$	Equation 17-32
$\sigma'_{vo} < \sigma'_p$ < σ'_f	$S_c = \sum_{i=1}^n H_o * \left[(C_{\epsilon r}) * \left(\log \frac{\sigma'_p}{\sigma'_{vo}} \right) + (C_{\epsilon c}) * \left(\log \frac{\sigma'_f}{\sigma'_p} \right) \right]$	Equation 17-33

Where,

 H_o = Thickness of i^{th} layer e_o = Initial void ratio of i^{th} layer σ'_f = Final pressure on the i^{th} layer

$$\sigma'_f = \sigma'_{vo} + \Delta\sigma_v \quad \text{Equation 17-34}$$

Where,

σ'_{vo} = initial vertical effective stress on the i^{th} layer

$\Delta\sigma_v$ = change in stress on the i^{th} layer

Where,

$\sigma'_p < \sigma'_{vo} < \sigma'_f$ = Soils that meet this condition are Underconsolidated

$\sigma'_{vo} = \sigma'_p < \sigma'_f$ = Soils that meet this condition are Normally Consolidated

$\sigma'_{vo} < \sigma'_f < \sigma'_p$ = Soils that meet this condition are Overconsolidated and are undergoing recompression only (i.e., these soils remain Overconsolidated)

$\sigma'_{vo} < \sigma'_p < \sigma'_f$ = Soils that meet this condition are Overconsolidated and transition to Normally Consolidated

17.9.2 Time for Settlement

As indicated previously, consolidation settlement occurs when a load is applied to a saturated Clay-Like soil squeezing water out from between the soil grains. The length of time for primary consolidation settlement to occur is a function of compressibility and permeability of the soil. The Coefficient of Consolidation (c_v) is related to the permeability (k) and the Coefficient of Vertical Compression (m_v) as indicated in the following equations

$$c_v = \frac{1}{\gamma_w} * \left(\frac{k}{m_v} \right) \quad \text{Equation 17-28}$$

$$m_v = \frac{\Delta\varepsilon_v}{\Delta\sigma'_v} = \frac{\Delta e}{\Delta\sigma'_v * (1 + e_{av})} \quad \text{Equation 17-29}$$

Where,

γ_w = Unit weight of water

$\Delta\varepsilon_v$ = Change in sample height

$\Delta\sigma'$ = Change in effective stress

Δe = Change in void ratio

e_{av} = Average void ratio during consolidation

The c_v is typically provided as part of the results of consolidation testing. A c_v is provided for each load increment applied during the test. The c_v used to determine the time for primary consolidation settlement should be at the stress (load increment) closest to the anticipated field conditions. If c_v is not provided, it should be determined using the procedures outlined in Munfakh, et al. (2001).

The time (t) for primary consolidation settlement is determined using the equation listed below.

$$t = \frac{T(H_o)^2}{c_v} \quad \text{Equation 17-30}$$

Where,

t = time for settlement

T = Time Factor from Equation 17-38

H_o = Maximum distance pore water must flow through

c_v = Coefficient of Consolidation

The distance the pore water must flow through is affected by the permeability of the materials above and below the Clay-Like material. If the Clay-Like material is between 2 Sand-Like materials (i.e., highly permeable materials) then the thickness of the Clay-Like material is cut in half. This is also known as 2-way or double drainage. If the Clay-Like material is bordered by an impermeable material, then the drainage path is the full thickness of the layer. This is called 1-way or single drainage. According to Das (1990), the time factor (T) is related to the degree of consolidation (U) in the following equations.

Equation 17-31

$$T = \frac{\left(\frac{\pi}{4}\right) * \left(\frac{U\%}{100}\right)^2}{\left[1 - \left(\frac{U\%}{100}\right)^{5.6}\right]^{0.357}} \leq 2.5$$

for

$$0 \leq U\% < 100\%$$

Equation 17-32

Where,

U% = Degree of Consolidation in percent

When U equals 100 percent, T approaches infinity (∞). The limit of T indicated in Equation 17-38 results in a U of 99.3%.

17.10 SECONDARY COMPRESSION SETTLEMENT

Secondary compression settlement occurs after the completion of primary consolidation settlement (i.e., U = 95%). This type of compression settlement occurs when the soil continues to vertically displace despite the fact that the excess pore pressures have essentially dissipated. Secondary compression typically occurs in highly plastic (PI > 21) or organic (percent organics > 30 percent) Clay-Like soils. Secondary compression settlement is evident on both the e-log p and the ε -log p curves (see Figure 17-19).

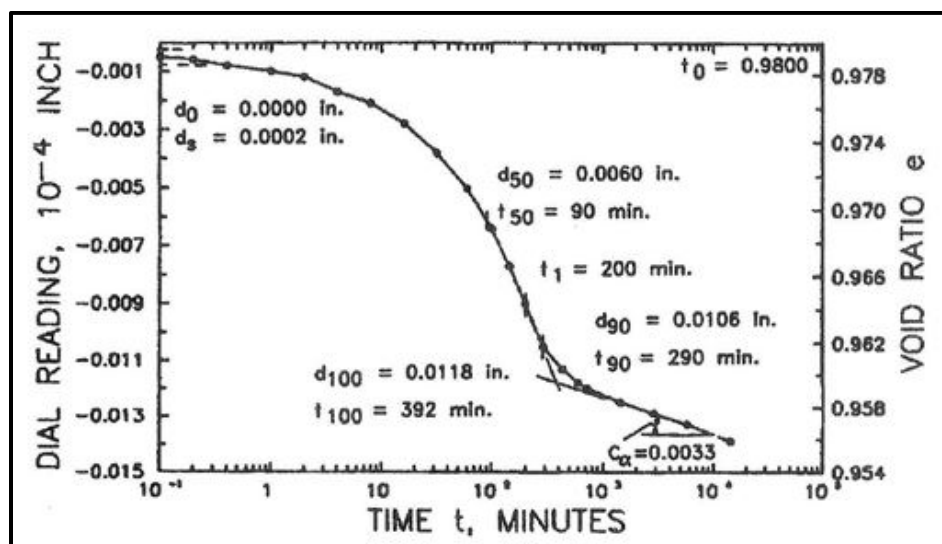

Figure 17-19, Secondary Compression (Munfakh, et al. (2001))

The Coefficient of Secondary Compression (C_{α}) can be determined using the slope of the corrected curve over 1 full logarithmic cycle. As with primary consolidation settlement, the amount of secondary compression settlement can be determined using either the e -log p or ϵ -log p curves. Presented in Table 17-9 are the equations for determining secondary compression settlement.

Table 17-9, Secondary Compression Settlement Equations

e-log p	$S_s = \sum_1^i H_o * \left(\frac{C_{\alpha}}{1 + e_o} \right) * \left(\log \frac{t_2}{t_1} \right)$	Equation 17-33
ϵ -log p	$S_s = \sum_1^i H_o * (C_{\epsilon\alpha}) * \left(\log \frac{t_2}{t_1} \right)$	Equation 17-34

Where,

H_o = Thickness of i^{th} layer

e_o = Initial void ratio of i^{th} layer

t_1 = Time when secondary compression begins (i.e., $U = 95\%$)

t_2 = Time when secondary compression is desired, usually the service life of structure

Secondary compression settlement is sometimes confused with creep. As indicated previously, secondary compression settlement occurs after the pore pressures have achieved a steady state condition and the settlement is the result of particle movement or realignment. Creep occurs after the pore pressures have achieved a steady state condition and there is no volume change. Creep is related to loss of shear strength with time rather than compressibility. In many cases, it is not possible to distinguish between creep and secondary compression settlement.

17.11 SETTLEMENT IN ROCK

The settlement procedures discussed previously are for soil. Rock is normally considered incompressible; however, the potential for settlement on rock does exist. The settlement of foundations on rock can be determined using elastic theory. The settlement determinations provided in this Section cover 4 combinations of rock (incompressible) and compressible layers (see Table 17-10).

**Table 17-10, Rock Settlements on various Geological Conditions
(Munfakh, et al. (2001))**

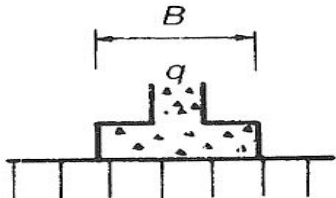
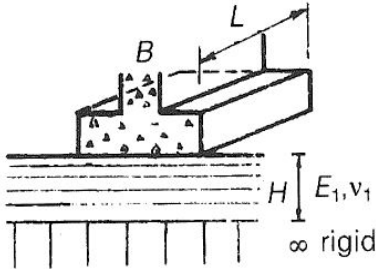
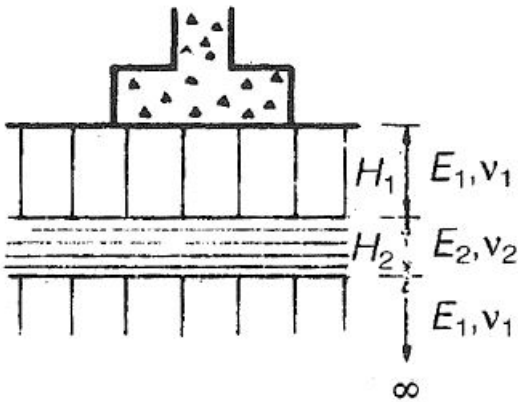
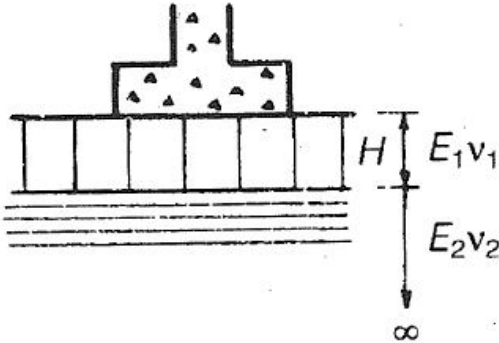
Geological Condition	Graph of Geological Condition	Settlement Calculations
Incompressible Layer		<ol style="list-style-type: none"> Determine shape factor C_d from Table 17-11; Calculate S_r using Equation 17-42
Compressible Layer on Incompressible Layer		<ol style="list-style-type: none"> Determine ratio of H/B_f & L/B_f; Determine shape factor C_d from Table 17-11; Calculate S_r using Equation 17-42
Compressible Layer between Incompressible Layers		<ol style="list-style-type: none"> Determine ratios $(H_1 + H_2)/B_f$ & L_f/B_f; Calculate weighted modulus (E) for upper two layers using Equation 17-43; Determine shape factor C'_d for ratio $(H_1 + H_2)/B_f$ from Table 17-12; Calculate S_r using Equation 17-42
Incompressible Layer on Compressible Layer		<ol style="list-style-type: none"> Determine ratios H/B_f & E_1/E_2; Determine factor α from Table 17-13; Determine shape factor C_d from Table 17-11; Calculate $S_{r\infty}$ using Equation 17-42 using elastic parameters E_2 & v_2 for overall foundation; Calculate S_r by reducing calculated $S_{r\infty}$ by α (see Equation 17-44)

$$S_r = \frac{C_d q B_f^*(1-\nu^2)}{E_m} \quad \text{Equation 17-35}$$

$$\bar{E} = \frac{(E_1 H_1 + E_2 H_2)}{(H_1 + H_2)} \quad \text{Equation 17-36}$$

$$S_r = \alpha S_{r\infty} \quad \text{Equation 17-37}$$

Where,

S_r = Rock Settlement

$S_{r\infty}$ = Settlement of incompressible layer underlain by a compressible layer

C_d = Shape Factor from Table 17-11

C'_d = Shape Factor from Table 17-12

q_0 = Applied vertical stress at the bottom of loaded area

B_f = Foundation width

ν = Poisson's ratio

E_m = Modulus of elasticity of rock mass (see Chapter 7)

E_1 = Modulus of elasticity of incompressible layer

E_2 = Modulus of elasticity of compressible layer

α = Elastic distortion settlement correction factor from Table 17-13

Table 17-11, Shape Factors, C_d
(Munfakh, et al. (2001))

Shape	Center	Corner	Middle of Short Side	Middle of Long Side	Average
Circle	1.00	0.64	0.64	0.64	0.85
Circle (rigid)	0.79	0.79	0.79	0.79	0.79
Square	1.12	0.56	0.76	0.76	0.95
Square (rigid)	0.99	0.99	0.99	0.99	0.99
Rectangle:					
Length/Width					
1.5	1.36	0.67	0.89	0.97	1.15
2	1.52	0.76	0.98	1.12	1.30
3	1.78	0.88	1.11	1.35	1.52
5	2.10	1.05	1.27	1.68	1.83
10	2.53	1.26	1.49	2.212	2.25
100	4.00	2.00	2.20	3.60	3.70
1000	5.47	2.75	2.94	5.03	5.15
10000	6.90	3.50	3.70	6.50	6.60

Table 17-12, Shape Factors, C'_d
(Munfakh, et al. (2001))

H/B_f	Circle Dia. (B_f)	Rectangle Shape Foundation (L_f/B_f)						
		1	1.5	2	3	5	10	∞
0.10	0.09	0.09	0.09	0.09	0.09	0.09	0.09	0.09
0.25	0.24	0.24	0.23	0.23	0.23	0.23	0.23	0.23
0.50	0.48	0.48	0.47	0.47	0.47	0.47	0.47	0.47
1.00	0.70	0.75	0.81	0.83	0.83	0.83	0.83	0.83
1.50	0.80	0.86	0.97	1.03	1.07	1.08	1.08	1.08
2.50	0.88	0.97	1.12	1.22	1.33	1.39	1.40	1.40
3.50	0.91	1.01	1.19	1.31	1.45	1.56	1.59	1.60
5.00	0.94	1.05	1.24	1.38	1.55	1.72	1.82	1.83
∞	1.00	1.12	1.36	1.52	1.78	2.10	2.53	∞

Table 17-13, Elastic Distortion Settlement Correction Factor, α
(Munfakh, et al. (2001))

H/B_f	E_1/E_2				
	1	2	5	10	100
0.00	1.000	1.000	1.000	1.000	1.000
0.10	1.000	0.972	0.943	0.923	0.760
0.25	1.000	0.885	0.779	0.699	0.431
0.50	1.000	0.747	0.566	0.463	0.228
1.00	1.000	0.627	0.399	0.287	0.121
2.5	1.000	0.550	0.274	0.175	0.058
5.0	1.000	0.525	0.238	0.136	0.036
∞	1.000	0.500	0.200	0.100	0.010

17.12 LATERAL SQUEEZE

Lateral squeeze is a phenomenon that occurs when a soft Clay-Like soil deforms and displaces when subjected to embankment loadings and is primarily a concern at the end bents where the deep foundations may be installed through thick layers of soft Clay-Like soils. In addition, if the thickness of the soft Clay-Like soil is finite and is less than the width of the sloped portion of the embankment (b_e) then the potential for lateral squeeze is present (Figure 17-20). This phenomenon can cause rotation and horizontal displacement of the end bent and can induce excessive loadings in the deep foundations. The following equation is used to determine if the potential for lateral squeeze exists at a site.

$$\gamma_f H_f > 3\tau$$

Equation 17-38

Where,

γ_f = Total unit weight of fill material

H_f = Height of fill

τ = Undrained shear strength (see Chapter 7)

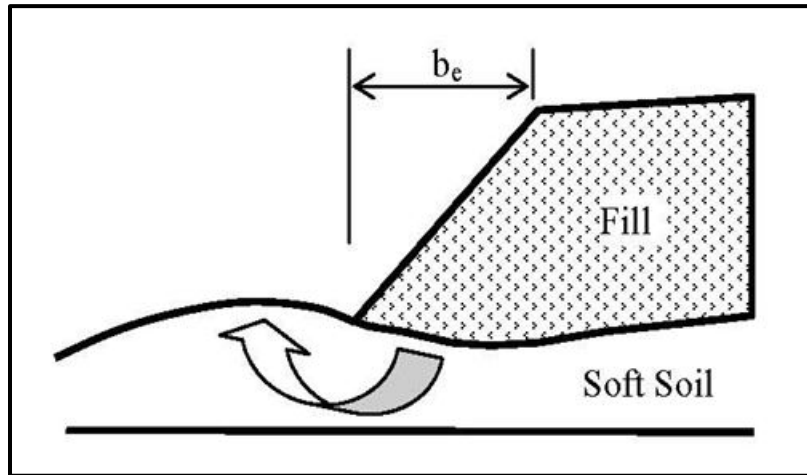

Figure 17-20, Schematic of Lateral Squeeze (Samtani and Nowatzki (2006))

If the load applied by the soil (fill height times fill unit weight) exceeds 3 times the undrained shear strength the potential for lateral squeeze is present; therefore, check the resistance against lateral squeeze using the following equation.

$$\phi = \left(\frac{\gamma_f D_s \tan \theta}{2\tau} \right) + \left(\frac{\gamma_f H_f}{4.14\tau} \right) \quad \text{Equation 17-39}$$

Where,

D_s = Depth of soft soil (see Figure 17-21)

θ = Slope angle

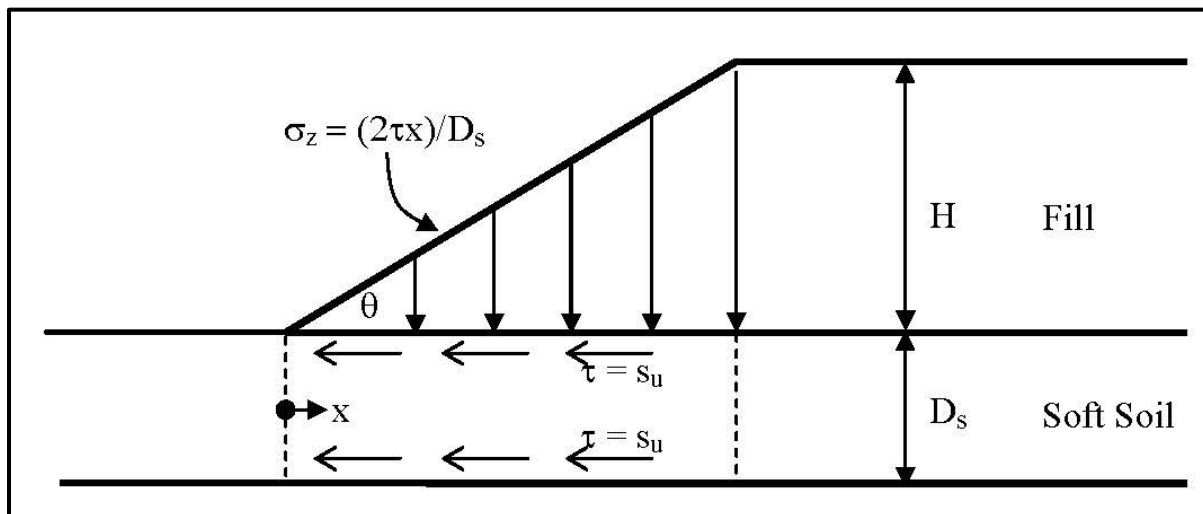

Figure 17-21, Lateral Squeeze Model (modified Samtani and Nowatzki (2006))

When D_s is greater than the width of the embankment, global stability of the embankment and the bearing resistance of the soft subgrade soils will typically govern design. If the ϕ is exceeded lateral movements of the soil may occur. These lateral movements may be estimated using the following equation.

$$\Delta_L = 0.25S_t \quad \text{Equation 17-40}$$

Where,

Δ_L = Horizontal displacement

S_t = Total settlement of fill

17.13 EMBANKMENT DESIGN

Embankments may be comprised of slopes and ERSs with unreinforced slopes and RSSs as a subset of slopes (see Figure 17-22 and Chapter 2). As indicated in Figure 17-22 all ERSs, RSSs, and slopes with angles greater than or equal to 1H:1V, require structural facing elements. Typically facing elements are comprised of panels, blocks, geotextile wrap, and wire baskets with geosynthetics. The purpose of the facing elements is to prevent the erosion of the soil material either behind or within the structure. Reinforced embankments and unreinforced slopes do not typically require facing elements; however, these slopes may require turf reinforced matting or other similar erosion control measures as required by the Stormwater Pollution Prevention Plan as prepared by the HEOR. If in the opinion of the GEOR, some form of erosion control is required contact the HEOR to determine if erosion control measures have already been included. If erosion control measures have not been included, the GEOR should request the HEOR include the requested measures. However, the design team may add facing elements if the site conditions warrant the use of these elements. Figure 17-22 is provided as a general guide and actual site conditions should dictate which type of embankment should be used. All proposed reinforced embankments and RSSs shall be evaluated using the ERS Selection Philosophy contained in Chapter 18. The use of this selection process will aide in the determination of whether the use of reinforced embankments or RSSs is justified. Discussed in the following Sections are limited design procedures and issues that should be considered in the design of embankments. See Figures J-4, J-6 and J-9 for flowcharts depicting typical analysis procedures for Bridge Embankments, LVB Embankments and Road Embankments, respectively.

Short-term (end-of-construction) and long-term loading conditions are typically used. The short-term condition loads should be comprised of the self-weight of the embankment and any live loads (i.e., traffic loads) applied at the top of the embankment. The long-term condition loads are similar to the short-term but should also include an additional dead load for the addition of pavement. As indicated previously, it is anticipated that the thickness of the addition pavement is estimated to be approximately 8 inches. Bridge embankment design shall include seismic loading and shall therefore, include the effects of the seismic event (i.e., SSL).

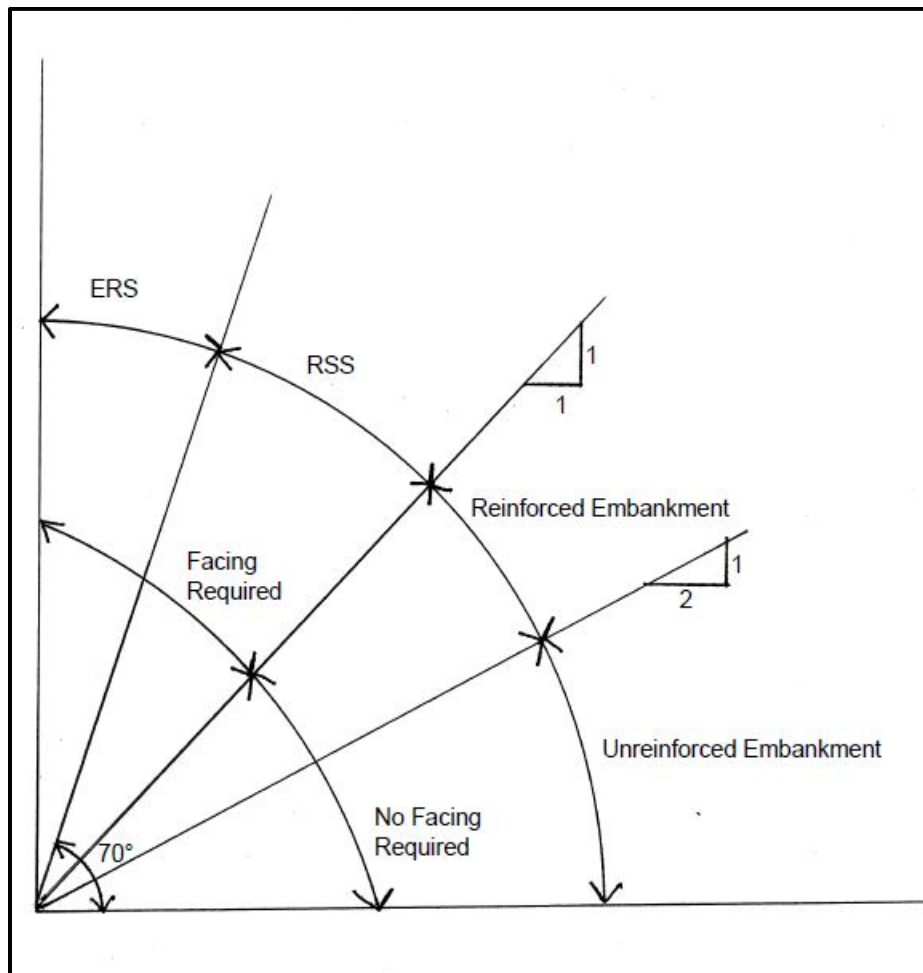

Figure 17-22, ERS vs Slope Diagram

The total settlement as well as the differential settlement (the difference in settlement between 2 points) should be considered in embankment design. Further, the time for settlement to occur as well as the rate of settlement (amount per unit of time) should also be considered in embankment design. The amount and time for settlement to occur shall be determined using the methods described earlier in this Chapter. Settlement shall be determined for the Service limit state. The amount (total and differential) and the rate of settlement at the Service limit state should conform to the limits presented in Chapter 10. Depending on the requirements of particular project the use of the Construction-Point Concept may be used. Unlike traditional settlement calculations which assume the bridge is instantaneously placed, the Construction-Point Concept determines the settlement at specific critical construction points (see Figure 17-23).

Temporary embankments whether unreinforced, reinforced embankments or RSSs shall follow the design procedures of this Section; however the ϕ indicated in Chapter 9 will be for temporary embankments. Temporary embankments are not designed for the EE limit state.

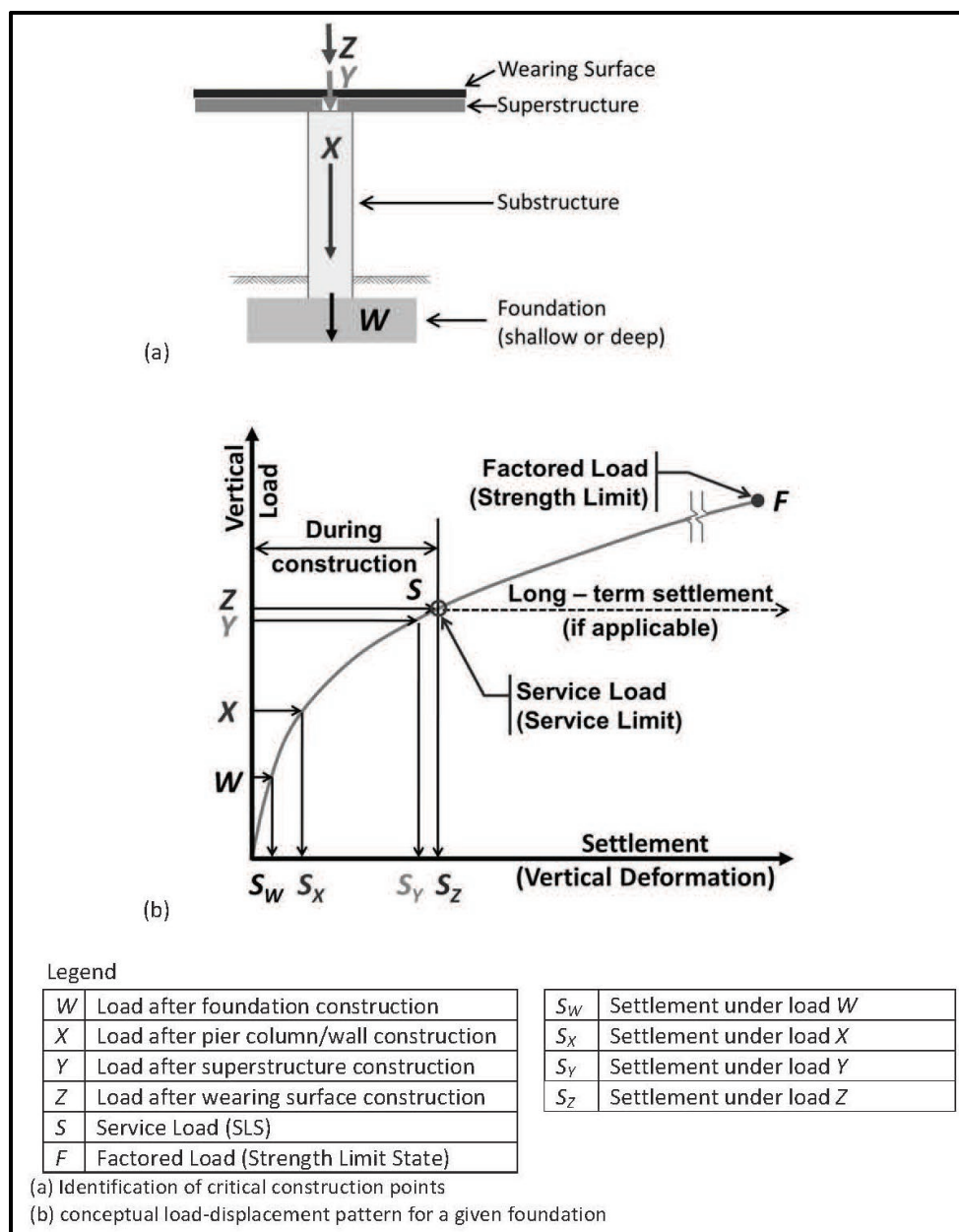

Figure 17-23, Construction-Point Concept (DeMarco, Bush, Samtani, Kulicki and Severns (2015))

17.13.1 Unreinforced Embankments

Unreinforced embankments typically have slopes equal to 2H:1V or flatter, are constructed of borrow materials and may comprise either bridge or roadway embankments. Roadway embankments as defined in Chapter 2 begin at the termination of the bridge embankment and shall be designed for the Strength limit state as indicated in Chapter 8. In addition, according to Table 17-1, there are conditions when slope stability analysis may not be required. While slope stability may not be required for certain roadway embankments, settlement shall be determined and reported to the design team for all roadway embankments. Bridge embankments shall be designed for Service/Strength as well as the EE limit state (see Chapter 8). Bridge embankments, regardless of height, shall always have slope stability analyses, except as note in Section 17.1,

as well as settlement analyses performed. All embankments should meet the Performance Objectives and Performance Limits as established in Chapter 10 for the appropriate limit state.

The following design procedure is adopted from the design steps presented in the Holtz, et al. (2008) and is applicable to both unreinforced as well as reinforced embankments.

1. Geometry and Loading Conditions – The geometric parameters required are the height and length of the embankment, the width of the crest (shoulder break-to-shoulder break), and the side slope angle. The loading conditions include any surcharges and any temporary or dynamic loads. The construction rate should also be included, because the gain in shear strength is directly affected by the placement of the embankments.
2. Soil Profile and Engineering Properties – The subsurface stratigraphy should be determined, including soil layering and groundwater table location for the foundation soils. The testing should include basic classification testing (see Chapter 4 for testing classification requirements). The shear strength and consolidation properties should be determined either from correlations with field testing or from laboratory testing. The spatial variation (length and depth) of the soil properties should also be determined.
3. Embankment Fill Engineering Properties – The engineering properties of the fill (borrow) material should be determined, including basic classification testing (see Chapter 4 for testing classification requirements), moisture-density relationship, shear strength, and chemical properties. A drainage media (e.g., free draining granular materials, non-woven geotextiles, etc.) should be placed at the interface between the existing subgrade and the embankment fill to permit drainage of water. Above this drainage media, normal backfill materials may be placed.
4. Establish Resistance Factors and Performance Limits – The Resistance Factors and Performance Limits shall meet the requirements contained in Chapters 9 and 10, respectively. The stability analyses performed in the following steps are for the Service/Strength limit state at the end of construction. The end of construction is the most critical condition. The EE will be checked using the shear strength anticipated from the increase with time as well as any affects from SSL.
5. Bearing Capacity Check – The bearing capacity of the subgrade soils can be checked using the procedures indicated in Chapter 15, using limit equilibrium analyses for strip footings and assuming a logarithmic spiral failure surface on an infinitely deep soil. When the thickness of soft foundation soil is much greater than the width of the embankment, the following equation may be used to determine the ultimate bearing capacity:

$$q_{ult} = \gamma_{fill} * H = c_u * N_c \quad \text{Equation 17-41}$$

Where,

q_{ult} = Ultimate bearing capacity

N_c = 5.14

c_u = Undrained shear strength of foundation soil

γ_{fill} = Unit weight of fill material

H = Height of embankment

If the thickness of the soft soil is less than the width of the embankment, check lateral squeeze using the procedure provided in Section 17.12.

6. Rotational Shear Stability Check – Perform a rotational slip surface analysis on the unreinforced embankment and foundation to determine the critical failure surface and the resistance factor against local shear instability. If the calculated resistance factor is less than required, then, reinforcement is not required. A resistance factor greater than required indicates slope instability and that reinforcement is required (see Section 17.13.2).
7. Sliding Block Stability Check – Perform a sliding block analysis. If the calculated resistance factor is less than required, then reinforcement is not required. If the resistance factor is inadequate, then reinforcement is required (see Section 17.13.2).
8. Estimate Magnitude and Rate of Embankment Settlement – The magnitude and rate of embankment settlement should be determined using the procedures outlined previously in this Chapter.
9. Establish Construction Sequence and Procedures – The construction sequence and procedures should be as clear and concise as possible to prevent misunderstandings during construction.
10. Establish Construction Observation Requirements – Since implemented construction procedures are crucial to the success of embankments, field personnel must be properly trained to observe every phase of the construction and to ensure that:
 - a. The specified material is delivered to the project
 - b. The specified construction sequence is explicitly followed

Instrumentation requirements should also be established. As typical instruments include piezometers, settlement points, surface survey points and slope inclinometers. Part of the instrumentation requirements is establishing who will obtain the measurements and how often the measurements will be obtained.

17.13.1.1 Unreinforced Embankments in Deep Water

If the depth of water is more than 5 feet, place riprap as defined by Section 804, Subsection 2.1 of the Standard Specifications. The riprap may be placed to a depth ranging from 5 feet below the water level surface to approximately 6 inches above the water level surface. A geosynthetic material acting as soil separator and meeting the requirements of STS for *Geosynthetic Materials for Separation and Stabilization* (SC-M-203-1) shall be placed between the riprap and the overlying materials to prevent the loss of fill materials into the voids of the riprap. The portion of the embankment constructed of riprap is an unreinforced embankment, a reinforced embankment or RSS may be placed on top of this portion.

17.13.2 Reinforced Embankments

Reinforced embankments are those embankments that require reinforcement to maintain stability, have slopes between 2H:1V and 1H:1V, and are constructed of borrow material as specified in the Standard Specifications. Geosynthetic reinforcement (either geogrids or geotextiles) is included in the stability analysis (see Section 17.5) unlike separation and stabilization geosynthetics which are not included in the stability analysis. Reinforced embankments may require some form of erosion control measures, the GEOR should contact the RPG/GDS and the RME to determine if this is required.

The design approach for the reinforced embankment is to prevent failure. Figure 17-24 provides depictions of potential modes of failure. These potential modes of failure indicate the type of analyses that will be required. However, reinforcement will not increase the bearing resistance of the foundation soil. Further, reinforcement will not reduce the magnitude of consolidation settlement or secondary compression of the embankment. Settlement of the embankment and the resulting creep of the reinforcement, need to be considered in design as well. Creep of the reinforcement only becomes an issue if the creep rate of the reinforcement is greater than the increase in shear strength of the subgrade soils. The most critical condition for embankment stability is typically at the end-of-construction. Therefore, a total stress analysis should be performed.

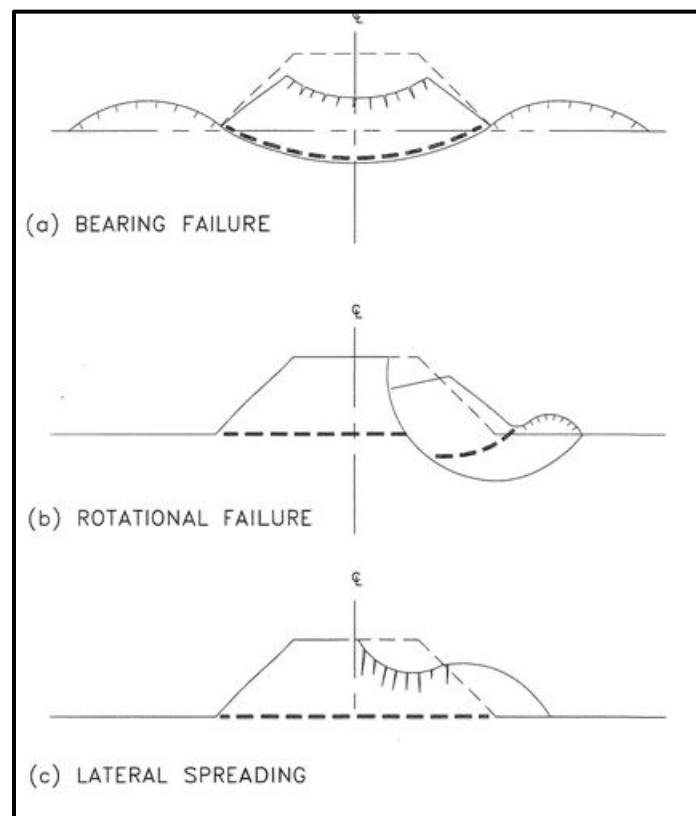

Figure 17-24, Reinforced Embankment Failure Modes (Holtz, et al. (2008))

In addition, reinforced embankments are also used over soft foundation soils that typically fall into 2 situations: first, construction over uniform deposits, and second, construction over localized anomalies (Figure 17-25). The most common application in transportation construction is the

placement of embankments over uniform soft soil foundations. Typically, the reinforcement is placed perpendicular to the centerline of the embankment to prevent long joints parallel to the centerline and the potential for sliding of the outer most reinforcement. As the end of the embankment is approached, the turning of the reinforcement may be required.

The reinforcement normally used consists of biaxial and uniaxial geogrids; however, geotextiles may also be used. The design using geotextiles is based upon constructability, survivability, and the amount of strain required to achieve the desired strength. In some cases the geotextile may require sewn seams. Sewn seams shall comply with the requirements of Chapter 20.

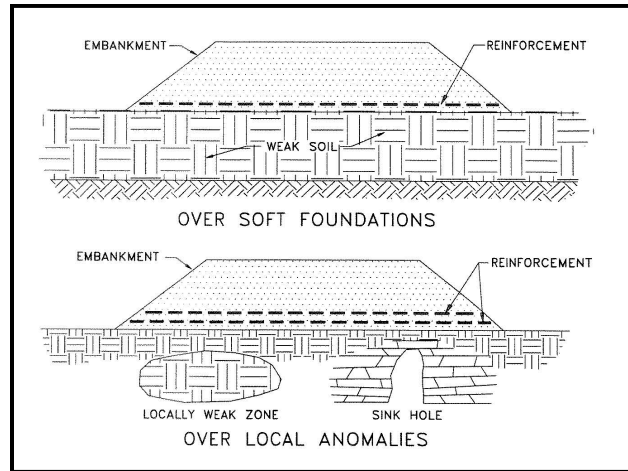

Figure 17-25, Reinforced Embankment Applications (Holtz, et al. (2008))

The procedure provided in Section 17.13.1 is used for the design of Reinforced Embankments except as modified. Specifically Steps 6 and 7 are modified by the following.

6. Rotational Shear Stability Check – If the determined resistance factor is greater than required (see Figure 17-24(b)), then, calculate the required reinforcement strength (T_g) to provide an adequate resistance factor using the Figure 17-26 and the following equation:

$$T_g = \frac{\Delta M_r}{y} \tag{Equation 17-42}$$

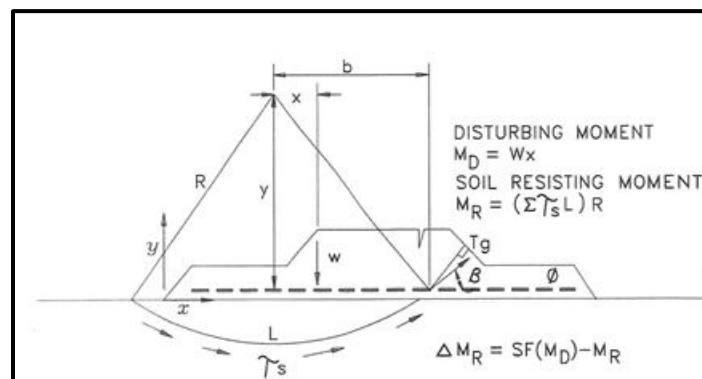

Figure 17-26, Rotational Failure Model (Holtz, et al. (2008))

Alternatively, instead of determining the required reinforcement strength, a suitable reinforcement strength from the available STSs may be used in the Sliding Block Stability Check.

The following steps are to be inserted between Steps 7 and 8 of the design methodology provided in Unreinforced Embankments, Section 17.13.1.

8. Establish Tolerable Geosynthetic Deformation – The deformation of the geosynthetic reinforcement is required to develop the tensile capacity required to prevent failure. The strain in the geosynthetic reinforcement is provided in the following equation.

$$\epsilon_{geosyn} = \frac{T_{ls}}{J} \quad \text{Equation 17-43}$$

Where,

ϵ_{geosyn} = Strain in the geosynthetic

Sand-Like Soils: $\epsilon_{geosyn} = 5$ to 10 percent

Clay-Like Soils: $\epsilon_{geosyn} = 2$ percent

Peats: $\epsilon_{geosyn} = 2$ to 10 percent

T_{ls} = Lateral spreading strength of reinforcement (required; not ultimate)

J = Reinforcement Modulus

The maximum strain in the geosynthetic reinforcement will be approximately twice the average strain in the embankment. The ϵ_{geosyn} shall be limited to 5 percent strain, since the available strength information for both geotextiles and geogrids is provided at 5 percent strain as well as at ultimate. Therefore, T_5 shall be provided on the plans, where T_5 is defined as the tension strength of a geosynthetic material at 5 percent strain. It is noted that T_5 is not reduced using the Reduction Factors for Installation Damage, Creep nor Durability.

9. Establish Geosynthetic Strength Requirements – Most embankments are relatively long and narrow in shape. Thus, during construction, stresses are imposed on the geosynthetic in the longitudinal direction (i.e., along the direction of the centerline). Reinforcement may also be required for loadings that occur at bridge abutments, and due to differential settlements and embankment bending, especially over nonuniform foundation conditions and at the edges of soft soil deposits, because both rotational and sliding block failures are possible in the direction along the alignment of the embankment. This determines the longitudinal strength requirements of the geosynthetic. Because the usual placement of the geosynthetic is in strips perpendicular to the centerline, the longitudinal stability will be controlled by the strength of the transverse seams.
10. Selection of Geosynthetic Reinforcement – Once the geosynthetic strength requirements are established, the geosynthetic reinforcement should be selected that meets the required strength and deformation (strain) requirements.
12. Establish Construction Sequence and Procedures – An example of the construction sequence of a reinforced embankment over soft ground is provided in Figure 17-29. In

addition, Figures 17-30 and 17-31 depict the placement of fill over soft ground and over firmer ground, respectively. Figure 17-32 provides an example of reinforcement placement for a widened embankment.

13. Establish Construction Observation Requirements – Modify Item 10 of Section 17.13.1, Establish Construction Observation Requirements presented previously by adding the following:
- a. The geosynthetic is not damaged during construction

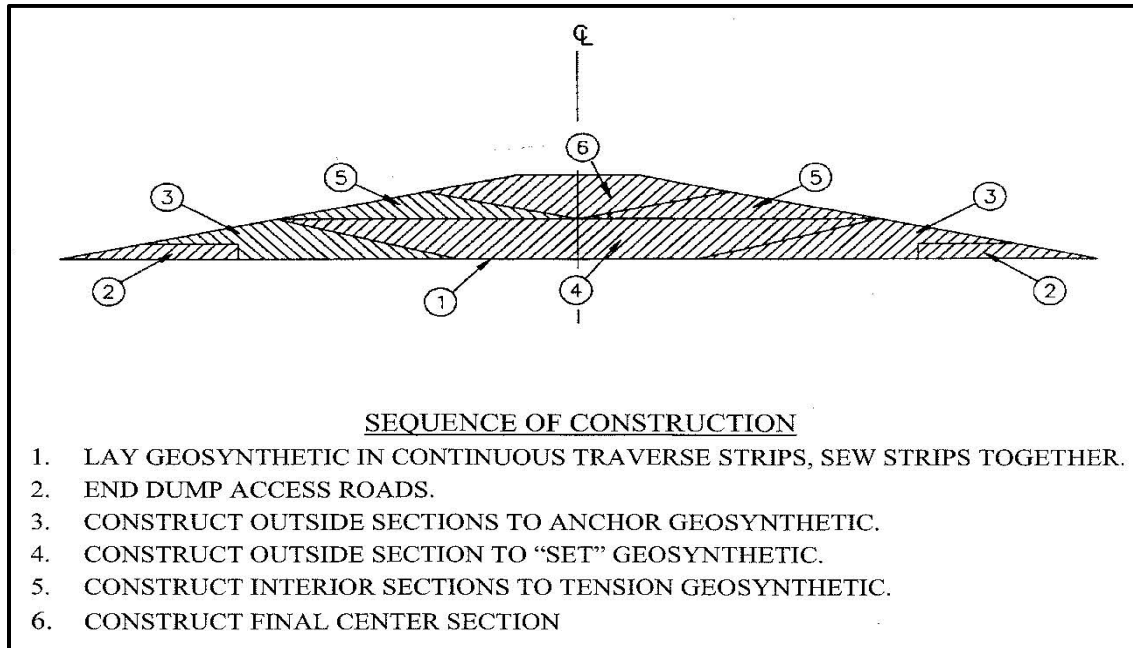

Figure 17-29, Reinforced Embankment Construction Sequence over Soft Ground (Holtz, et al. (2008))

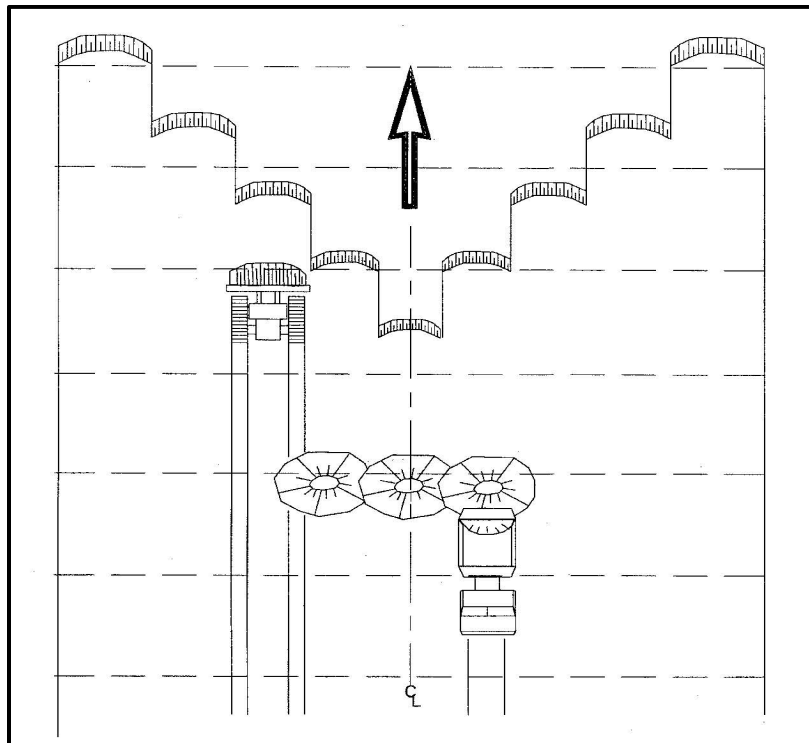

Figure 17-30, Fill Placement over Soft Ground (Holtz, et al. (2008))

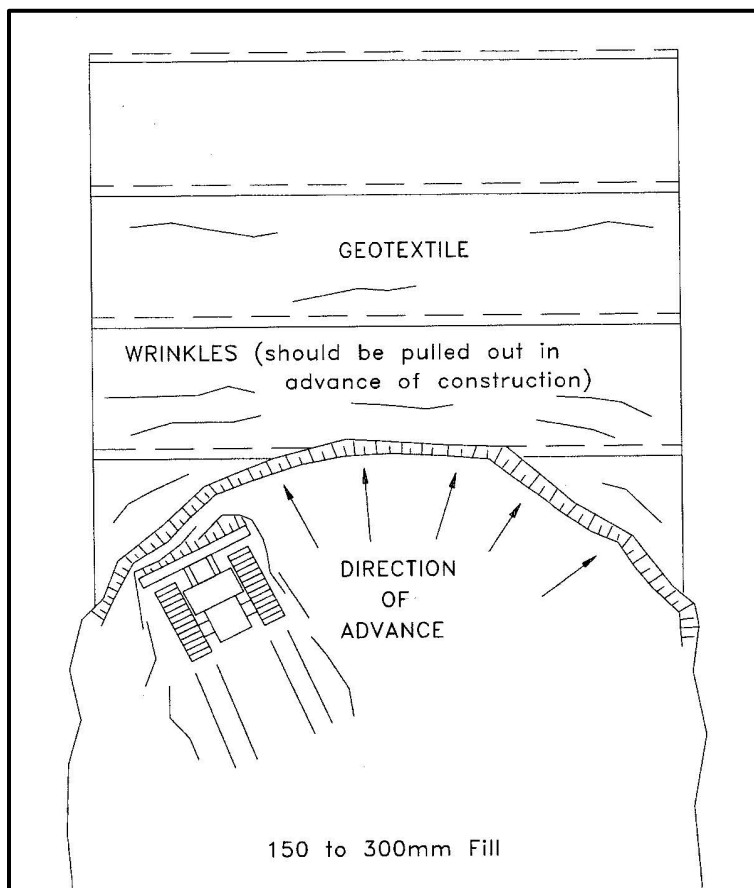

Figure 17-31, Fill Placement over Firm Ground

(Holtz, et al. (2008))

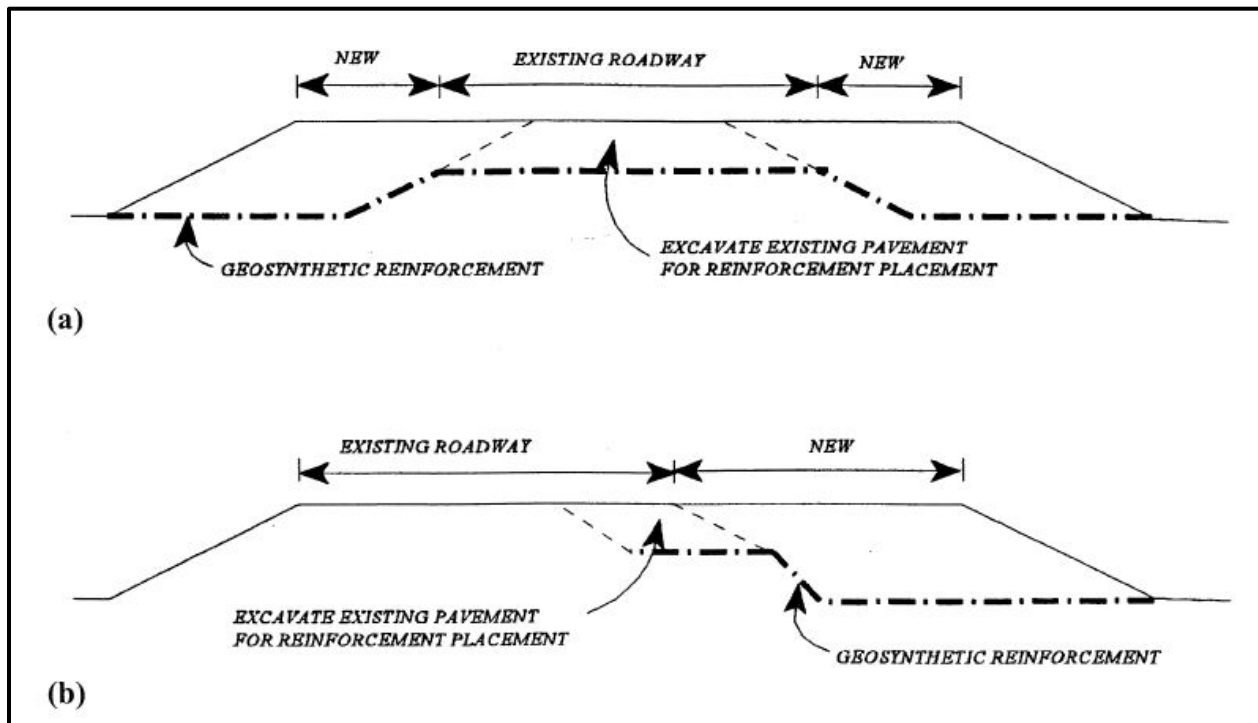
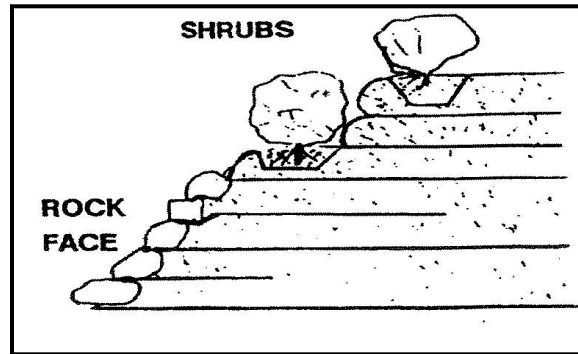

Figure 17-32, Geosynthetic Reinforcement Placement for Widened Embankments (Holtz, et al. (2008))

17.13.3 Reinforced Soil Slopes

RSSs have slopes ranging from equal to 1H:1V to 70°, require reinforcement to maintain stability and require select backfill materials for construction. Appendix D and the SCDOT STS entitled *Reinforced Soil Slopes* (SC-M-206-1) shall be consulted for the gradation requirements of the select backfill materials. RSSs consist of reinforcement arranged in horizontal planes in the reinforced mass to resist the outward movement of this mass. The reinforcement allows the reinforced mass to act more rigidly than in an unreinforced soil slope. Facing treatments can range from vegetated to flexible armor systems that are applied to prevent unraveling and sloughing off of the face (see Figure 17-33). Roadway embankment RSSs shall only be designed for the Service/Strength limit state condition and shall have both slope stability analyses as well as settlement analyses performed. Bridge embankment RSSs shall be designed for both the Service/Strength and EE limit states. All RSS embankments shall meet the Performance Objectives and Performance Limits as established in Chapter 10 for the appropriate limit state. Appendix D contains detailed design methodologies for RSSs. Table 17-14 provides the design steps that are used in the design of RSS.



**Figure 17-33, Reinforced Soil Slope
(Berg, Christopher, and Samtani (2009))**

**Table 17-14, RSS Design Steps
(modified from Berg, Christopher, and Samtani (2009))**

Step	Action
1	Establish project requirements including all geometry, external loading conditions (transient and/or permanent, seismic, etc.), performance criteria and construction constraints.
2	Evaluate existing topography, site subsurface conditions, and in-situ soil/rock parameters.
3	Determine properties of available fill materials.
4	Evaluate design parameters for the reinforcement.
5	Check unreinforced stability.
6	Design reinforcement to provide stable slope.
7	Determine type of reinforcement.
8	Check external stability (static and seismic): <ul style="list-style-type: none"> • Bearing capacity • Settlement • Rotational slope stability • Sliding slope stability
9	Evaluate requirements for subsurface and surface water control.
10	Establish construction: <ul style="list-style-type: none"> • Sequence and procedures • Observation requirements

The overall design of RSSs is similar to unreinforced slopes. However, there are 3 possible modes of slope failure (see Figure 17-34):

- I. Internal – failure plane passes through reinforced soil mass
- II. External – failure plane passes behind and underneath reinforced soil mass
- III. Compound – failure plane passes behind and through reinforced soil mass

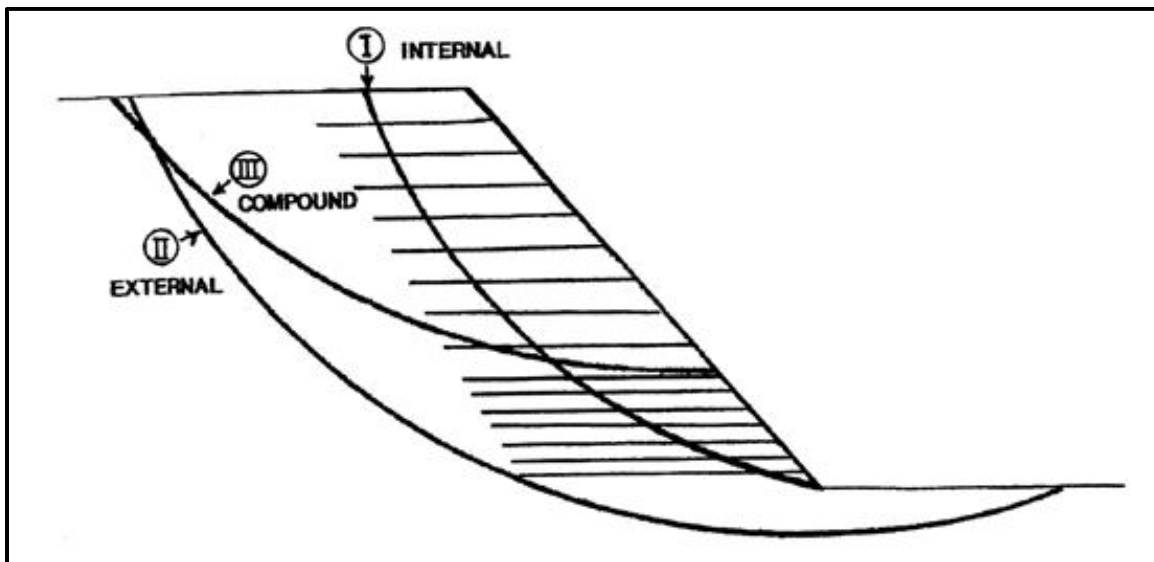

Figure 17-34, Reinforced Soil Slope Failure Modes
(Berg, Christopher, and Samtani (2009))

17.13.4 Vertical Stage Construction

As indicated previously, the placement of embankments over very soft to soft Clay-Like soils may require vertical staging of the construction to prevent instability. The instability is caused by the low shear strength of the Clay-Like soil and the increase in excess pore pressures. The increase in pore pressures lowers the undrained shear strength of the soil; however, with the dissipation of the excess pore pressures, the effective strength of the soil will increase. Therefore, vertical staging can be used to increase the soil shear strength by placing a stage (thickness) of soil over the soft Clay-Like soil and allowing the excess pore pressures to dissipate (waiting period). Determine ϕ_{temp} at the end of each vertical stage (i.e., immediately after the completion of fill placement, but prior to the dissipation of any pore pressures) for both lateral squeeze and for slope stability using a total stress approach. The completion of placement of each stage is critical; since this is when instability is most likely to occur (i.e., the soil shear strength has not increased). Determine $\phi_{\text{permanent}}$ again at the completion of waiting period (i.e., once the excess pore pressures have dissipated), but prior to the placement of any additional fill materials, for both lateral squeeze and slope stability. Then the next stage can be placed. This process can be repeated until the final height of the embankment is achieved. Further additional soil materials (i.e., surcharge) may be added to the embankment height to increase the loading and thus reducing the time to achieve the required settlement. Settlement at each stage will also occur as the excess pore pressures dissipate (see Figure 17-35). Therefore, consolidation testing is required to determine the time rate of settlement, as well as the magnitude of total settlement, that is anticipated for each stage as well as the full embankment. If the time rate of settlement indicates that the waiting periods are too long, then prefabricated vertical (wick) drains may be used to increase the time to complete settlement. The increase in shear strength is a function of the Degree of Consolidation (U). Provided below are equations based on Ladd (1991) and Ladd and Foott (1974) relating the increase in undrained shear strength to U .

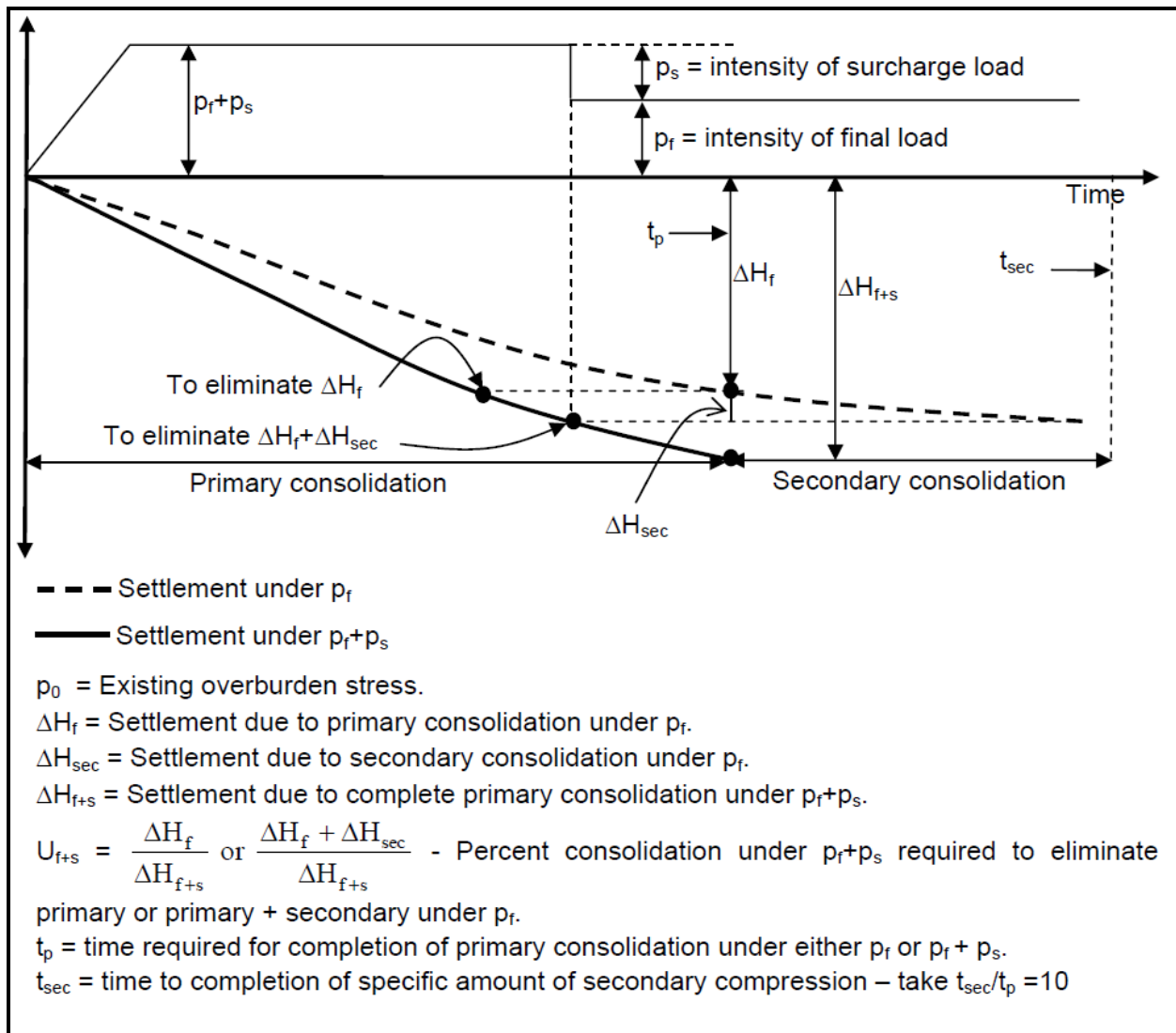

Figure 17-35, Staged Construction Schematic (McVay and Nugyen (2004))

$$\Delta c_u = U_t * [\Delta \sigma * \tan(\phi_{cu})] \quad \text{Equation 17-44}$$

Alternately,

$$\Delta c_u = U_t * \left[\Delta \sigma * \left(\frac{\tau}{\sigma'_{vo}} \right) \right] \quad \text{Equation 17-45}$$

Where,

$$\tan(\phi_{cu}) = \frac{\tau}{\sigma'_{vo}} = 0.23 * (OCR)^{0.8} \quad \text{Equation 17-46}$$

Where,

- Δc_u = Increase in undrained cohesion
- U_t = Degree of consolidation at a specific time (enter as decimal)

$\Delta\sigma$	=	Increase in applied vertical stress
ϕ_{cu}	=	Consolidated undrained internal friction angle
τ	=	Undrained Shear Strength
σ'_{vo}	=	Vertical effective overburden stress
OCR	=	Overconsolidation Ratio (see Chapter 7)

The soil shear strength and consolidation parameters should be determined in accordance with the procedures outlined in Chapter 7. See Chapter 19 for information concerning prefabricated vertical drain design. The stability of the embankment should be monitored using the instrumentation described in Chapter 25.

17.13.5 Cut Slopes

Sections 17.13.1 to 17.13.4 consider how a fill slope (unreinforced, reinforced or RSS) is to be constructed. These methods do not apply to cut slopes, regardless of whether the slope is natural or man-made. The cut slope shall be cut back to angle that will achieve the required ϕ as indicated in Chapter 9. If the slope angle of a cut slope cannot be reduced, then the use of a Soil Nail Wall should be considered, down to a slope angle of 2H:1V. For cut slopes flatter than this, other in-situ reinforcement methods should be considered. If the cut slope extends into and beneath a water surface, consult with the OES/GDS on appropriate design and construction procedures. As indicated previously, permanent cut slopes shall be designed using residual shear strength parameters. Temporary cut slopes may be designed using peak shear strength parameters. This applies to all soils and geologic conditions.

Cut slopes located in the Piedmont Geologic Physiographic Province may require additional design effort, since soils having a very high N-values (N-field greater than 50 blows for 6 inches of penetration) or rock ($V_p \leq 8,000$ feet per second or $V_p > 8,000$ feet per second) may be encountered. To avoid or limit the need for blasting of these very dense soils or rock, use the compression wave velocities obtained during the site exploration to determine the average compression wave velocity within the materials to be cut. Using Table 17-15, determine the approximate fly wheel horsepower that will be required to rip these materials.

Table 17-15, Rippability Chart

Fly Wheel Horsepower	V_p (feet per second)
305	6,000
405	7,000
570	7,500
850	8,000

Materials to be cut that are considered rippable according to Table 17-15, should be considered to be "Unclassified Excavation" and should be included in that quantity. Materials to be cut that have a $V_p > 8,000$ feet per second should be considered "Rock Excavation" and should be included in that quantity.

17.13.6 Pipe Culverts

Pipe culverts having a diameter or inside dimension of 48 inches or more and are located on a road having a current ADT of 5,000 vpd (vehicles per day) or more that are located within an embankment, regardless of whether the embankment is unreinforced, reinforced or an RSS, shall have a settlement profile determined. The settlement at specific points are anticipated being symmetrical to the centerline of the embankment, use the following locations as required in Chapter 10 to determine the settlement profile:

- Centerline of the embankment
- A distance halfway between the centerline and the shoulder break, both right and left
- Shoulder break, both right and left
- A distance halfway between the shoulder break and the toe of slope, both right and left
- Toe of slope, both right and left

After determining the settlements along the pipe culvert, prepare a plan depicting the plan and profile of the pipe culvert. The plan view should show the locations where the settlement was determined. The profile view should show the pipe culvert and the anticipated settlement at each location shown in the plan view. Also include on the plan a table that indicates the station, distance right and left of centerline and the amount of settlement. Provide this plan to the SEOR and HEOR for their evaluation of the settlement. As indicated in Chapter 10 no performance limits have been established for these pipe culverts as part of the GDM; however performance limits should be established by the Design Team.

17.14 PLANS

This Section details the information that should be placed on construction drawings related to embankment construction. For an unreinforced embankment, no information is required in the construction drawings. If project specific shear strength is required for the borrow materials that exceeds both the on-site shear strength parameters and the county maximum shear strength value, then a Special Provision shall be prepared (see Chapter 7). The GEOR is reminded that the use of a Special Provision will require a 60-day advertisement for construction. The requirements for plans for reinforced embankments and RSSs are contained in Chapter 22 and Appendix D.

17.15 REFERENCES

American Association of State Highway and Transportation Officials, (2017), AASHTO LRFD Bridge Design Specifications Customary U.S. Units, 8th Edition, American Association of State Highway and Transportation Officials, Washington, D.C.

Berg, R. R., Christopher, B. R., and Samtani, N. C., (2009), Design of Mechanically Stabilized Earth Walls and Reinforced Soil Slopes – Volume II, (Publication No. FHWA NHI-10-025; FHWA GEC 11 – Volume II), National Highway Institute, Federal Highway Administration, U.S. Department of Transportation, Washington D.C.

Bowles, J. E., (1986), Foundation Analysis and Design, Fifth Edition, The McGraw-Hill Companies, Inc.

Briaud, J.-L. and Miran, J., (1992), The Flat Dilatometer Test, (Publication No. FHWA-SA-91-044), Office of Technology Applications, Federal Highway Administration, U.S. Department of Transportation, Washington D.C.

Christian, J. T. and Carrier III, W. D., (1978), "Janbu, Bjerrum and Kjaernsli's Chart Reinterpreted," Canadian Geotechnical Journal, Volume 15, Issue No. 1, pp 123 - 128.

Collin, J. G., Leshchinsky, D., and Hung, C.-J. J., (2005), Soil Slope and Embankment Design – Reference Manual, (Publication No. FHWA NHI-05-123), National Highway Institute, Federal Highway Administration, U.S. Department of Transportation, Washington D.C.

Das, B. M., (1990), Principles of Foundation Engineering, 2nd Edition, PWS-Kent Publishing Company, Boston, Massachusetts.

DeMarco, M., Bush, P., Samtani, N. C., Kulicki, J. M., and Severns, K., (2015), Draft-Incorporation of Foundation Deformations in AASHTO LRFD Bridge Design Process, 2nd Strategic Highway Research Program (SHRP2), Transportation Research Board, The National Academies of Sciences, Engineering, and Medicine, Washington, D.C.

Department of Defense, Department of the Army, Army Corps of Engineers (USACE), (1990), Settlement Analysis, EM 1110-1-1904, Washington D.C.

Department of Defense, Department of the Army, Army Corps of Engineers (USACE), (2003), Slope Stability, EM 1110-2-1902, Washington D.C.

Department of Defense, Department of the Navy, Naval Facilities Engineering Command (NACFAC), (1982), Soil Mechanics – Design Manual 7.1, Publication No. NAVFAC DM-7.1, Alexandria, Virginia.

Duncan, J. M. and Buchignani, A. L., (1976), *An Engineering Manual for Settlement Studies*, University of California at Berkeley, Berkeley, California.

Duncan, J. M., Wright, S. G., and Brandon, T. L., (2014), Soil Strength and Slope Stability, 2nd Edition, John Wiley & Sons, Inc., New Jersey

Hough, B. K., (1959), "Compressibility as the Basis for Soil Bearing Values," Journal of Soil Mechanics and Foundations Division, ASCE, Vol. 84, No. SM 4, August, pp 10 - 39.

Ladd, C. C., (1991), "Stability Evaluation During Staged Construction," Journal of Geotechnical Engineering, ASCE, Vol. 117, No. 4, April, pp 540 - 615.

Ladd, C. C. and Foott, R., (1974), "New Design Procedure for Stability of Soft Clays," Journal of the Geotechnical Engineering Division, ASCE, Vol. 100, No. GT7, July, pp 763 - 786.

McVay, M. C. and Nugyen, D., (2004), Evaluation of Embankment Distress at Sander's Creek – SR20, BC 354, RPWO# 17, Department of Civil and Coastal Engineering, University of Florida, Gainesville, FL.

Meyerhof, G. G. (1965), "Shallow Foundations," Journal of the Soil Mechanics and Foundations Division, ASCE, Vol. 91, No. SM 2.

Munfakh, G., Arman, A., Collin, J. G., Hung, C.-J. J., and Brouillette, R. P., (2001), Shallow Foundations – Reference Manual, (Publication No. FHWA NHI-01-023), National Highway Institute, Federal Highway Administration, U.S. Department of Transportation, Washington D.C.

Munfakh, G., Wylie, D., and May, C. W., (1998), Rock Slopes – Reference Manual, (Publication No. FHWA-HI-99-007), National Highway Institute, Federal Highway Administration, U.S. Department of Transportation, Washington D.C.

Newmark, N. M., (1935), "Simplified Computation of Vertical Pressures in Elastic Foundations", *University of Illinois Engineering Experiment Station Circular 24*, University of Illinois, Urbana, Illinois, <http://hdl.handle.net/2142/49868>.

Osterberg, J. O. (1957), "Influence Values for Vertical Stresses in a Semi-infinite Mass Due to an Embankment Loading," *Proceedings of the Fourth International Conference on Soil Mechanics and Foundation Engineering*, London, England.

Samtani, N. C. and Nowatzki, E. A., (2006), Soils and Foundations Reference Manual – Volume I, (FHWA Publication No. FHWA-NHI-06-088), National Highway Institute, Federal Highway Administration, U.S. Department of Transportation, Washington D.C.

Schmertmann, J. H. (1970), "Static Cone to Compute Static Settlement Over Sand," Journal of Soil Mechanics and Foundations Division, ASCE, Vol. 96, No. SM 3, May, pp 1011 - 1043.

Spencer, E. (1967), "A Method of Analysis of the Stability of Embankments Assuming Parallel Inter-Slice Forces", *Geotechnique*, Vol. 17, Issue 1, pp. 11-26.

Terzaghi, K. and Peck, R., (1967), Soil Mechanics in Engineering Practice, 2nd Edition, John Wiley & Sons.

Timoshenko, M. J. and Goodier, J. N., (1951), Theory of Elasticity, 2nd Edition, McGraw-Hill Book Company, Inc.

USGS (United States Geologic Survey), (2004), Landslide Types and Processes, Fact Sheet 2004-3072, <http://pubs.usgs.gov/fs/2004/3072/pdf/fs2004-3072.pdf>, U.S. Department of the Interior, Washington, D.C.

Wright, S. G. (1969), "A Study of Slope Stability and the Undrained Shear Strength of Clay Shales," thesis presented to the University of California at Berkeley, California, in partial fulfillment of requirements for degree of Doctor of Philosophy.