

APPENDIX L

Appendix/Attachment Title

Supplement Guide for Element-Level Condition States

Appendix/Attachment Revision and Year:

Version 1.0, 2020

Appendix/Attachment Introduction and Discussion

This appendix is to be used when collecting element level data. This appendix supplements the *AASHTO Manual for Bridge Element Inspection* and the *Guide Manual for Bridge Element Inspection* provides further classification of the AASHTO elements.

The most effective tool for proper bridge management is the consistent condition assessment of bridge elements. The element level inspection method breaks the bridge down into several elements, such as the railing, deck, girders, abutments, pier columns, etc. Each element is inspected and assigned a Condition State based on the amount of deterioration. The element level inspection is a quantity-based inspection, and each quantity is assigned a Condition State to reflect the differing categories of deterioration that often exist on any bridge element.

Appendix/Attachment Description

This appendix describes the individual bridge elements evaluated in bridge inspection and management processes. The guide included in this appendix may be used by inspectors when performing their evaluation of the structure elements following an inspection. See Appendix K for the guide for Condition Ratings.

The first portion (Sections 1 to 9) of this appendix contains a detailed description for each element and is broken down into the following subsections:

- Element Number and Name
- Description—Detailed identification and classification of the element.
- Quantity Calculation—General guidelines on how to collect the quantity of the element and units.
- Element Commentary—Additional considerations to be aware of during data collection.
- Condition State Table to Reference

The condition state tables are in the second portion of this appendix (Section 10). They contain the following information:

- Condition State Definitions—Defect descriptions and severity with guidelines for the inspector on defect severity categorization.
- Pictures – Example cases of condition states.

All elements described are included in the standard set of National Bridge Elements (NBE) or Bridge Management Element (BME). The elements are organized by major groupings such as Decks and Slabs, Superstructure, Bearings, Substructure, etc.

The third portion of this appendix contains defect hierarchy, Section 11.

The fourth portion of this appendix contains guidance on some of the more difficult situations to properly quantify, Section 12.

The fifth portion contains guidance on coding the scour defect for substructure elements, Section 13.

TABLE OF CONTENTS

1. Decks and Slabs	L-3
2. Approach Slab (sq. ft.)	L-5
3. Bridge Railing (ft.)	L-6
4. Superstructure.....	L-7
5. Wearing Surfaces (sq. ft.).....	L-13
6. Protective Coating (sq. ft.)	L-13
7. Bearings (ea.)	L-14
8. Substructure.....	L-14
9. Culvert.....	L-18
10. Condition State Tables	L-19
11. Defect Hierarchy	L-42
12. Additional Guidance on Element Quantities.....	L-47
13. Scour Defect.....	L-51

GENERAL

Element-level condition states may be converted to NBI Condition Ratings and vice versa according to the recommendations below. See Appendix K for component-level guidance on Condition Ratings. The conversions below are not to be used as a direct correlation but as a tool in weighing element-level condition states to the general condition rating of the component.

- Condition State 1 = NBI Condition Rating of 9, 8 or 7
- Condition States 2 or 3 = NBI Condition Rating of 6 or 5
- Condition State 4 = NBI Condition Rating of 4 or below

Guidance of Environmental Factors for Condition States for elements is located in Section 7.2.5.4 of the BIGD.

1. DECKS AND SLABS

Decks and slabs describe the components that transfer loads from vehicles to the bridge.

Deck structures transmit loads to superstructure systems. Slab elements transmit loads to the substructure. Structures that include slab elements typically do not have superstructure elements. These elements transmit traffic loads directly to the substructure.

Included in the decks/slabs grouping are the secondary deck elements of girder top flange, deck fascia, joints and any false decking or maintenance sheeting.

DECK (SQ. FT.)

Description: This element defines all bridge decks regardless of the wearing surface or protection systems used. Decks carry traffic and transfer loads to the superstructure.

No.	Name	CS Table	Description
12	Reinforced Concrete	1	Reinforced concrete bridge decks
13	Prestressed Concrete	2	Prestressed concrete bridge decks.
28	Steel with Open Grid	3	All open grid steel decks with no fill.
29	Steel with Concrete Filled Grid	3	Steel bridge decks with concrete fill either in all of the openings or within the wheel tracks.
30	Steel - Corrugated/ Orthotropic/Etc.	3	Corrugated metal filled with portland cement, asphaltic concrete or other riding surfaces and Orthotropic steel. Materials added for riding surface are not part of the element condition.
31	Timber	4	Timber Bridge Decks. Timber running planks shall be included under the wearing surface assessment. (See pg. N-11)
60	Other	6	Composite materials or other materials that cannot be classified using any other defined deck element.

Quantity Calculation: Includes the area of the deck from edge to edge and reference line to reference line, including any median areas and accounting for any flares or ramps present. Deck area shall be calculated based on the out-to-out width of the deck and the total length of the bridge (back-to-back of backwalls or end-to-end of slab).

Element Commentary: The deck evaluation is three dimensional in nature with the defects observed on the top surface, bottom surface, edges or all; and being captured using the defined condition states. Deck top or bottom surfaces that are not visible for inspection shall be assessed based on the available visible surface. If both top and bottom surfaces are not visible, the condition shall be assessed based on destructive and nondestructive testing or indicators in the materials covering the surfaces. Both the severity and density of spalls, delaminations, or patched areas, and severity and density of cracks and the existence of rust staining should be considered for the evaluation of the deck elements. A bridge may be composed of several deck elements i.e. Element 12 – Reinforced Concrete Deck and Element 28 - Steel Deck, Open Grid. For this example, both elements shall be coded.

DECK (SQ. FT.) (CONTINUED)



12 Reinforced Concrete

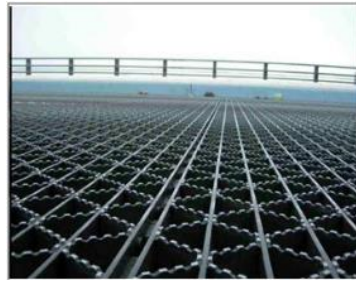

28 Steel Open Grid



31 Timber Deck

SLAB (SQ. FT.)

Description: This element defines all bridge slabs regardless of the wearing surface or protection systems used. Slabs carry traffic and transfer loads to the substructure. Deck Elements and Slab Elements are defined separately. Care should be taken to define these elements correctly. Slab Elements are stand-alone structures such as slab spans. Primary structural members, such as steel beams or prestressed beams, support Deck Elements.

No.	Name	CS Table	Description
38	Reinforced Concrete Slab	1	Reinforced concrete bridge slabs.
54	Timber Slab	4	Timber bridge slabs. Timber running planks shall be included under the wearing surface assessment. (See pg. N-11)
65	Other Slab	6	Composite materials or other materials that cannot be classified using any other defined slab element.

Quantity Calculation: Includes the area of the deck from edge to edge and reference line to reference line, including any median areas and accounting for any flares or ramps present.

Element Commentary: The slab evaluation is three dimensional in nature with the defects observed on the top surface, bottom surface, edges or all; and being captured using the defined condition states. Slab top or bottom surfaces that are not visible for inspection shall be assessed based on the available visible surface. If both top and bottom surfaces are not visible, the condition shall be assessed based on destructive and nondestructive testing or indicators in the materials covering the surfaces.

TOP FLANGE (SQ. FT.)

Description: This element defines all bridge girder top flanges where traffic rides directly on the structural element whether or not a wearing surface or protective system is present. These bridge types include bulb-tees, tee-beams, box girders and girders where traffic rides directly on the structural element.

No.	Name	CS Table	Description
15	Prestressed Concrete Top Flange	2	Prestressed concrete bridge girder top flanges.
16	Reinforced Concrete Top Flange	1	Reinforced concrete bridge girder top flanges.

Quantity Calculation: The quantity for this element includes the area of the top flange from edge to edge and reference line to reference line, including any median areas and accounting for any flares or ramps present. This quantity is for the top flange riding surface only. Girder web and bottom flange to be evaluated by the appropriate girder element.

Element Commentary: The flange evaluation is three dimensional in nature with the defects observed on the top surface, bottom surface, or both, and being captured using the defined condition states. Flange top or bottom surfaces that are not visible for inspection shall be assessed based on the available visible surface. If both top and bottom surfaces are not visible, the condition shall be assessed based on destructive and nondestructive testing or indicators in the materials covering the surfaces. An example of a prestressed concrete top flange is included at the end of this appendix.

JOINTS (FT.)

Description: These elements define bridge deck or slab joints and pavement relief joints.

No.	Name	CS Table	Description
300	Strip Seal Expansion Joint	8	Expansion joint devices that utilize a neoprene type waterproof gland with some type of metal extrusion or other system to anchor the gland.
301	Pourable Joint Seal	8	Joints filled with a pourable seal with or without a backer.
302	Compression Joint Seal	8	Joints filled with a preformed compression type seal. This joint does not have an anchor system to confine the seal.
303	Assembly Joint with Seal	8	Joints filled with an assembly mechanism that have a seal.
304	Open Expansion Joint	8	Joints that are open and not sealed.
305	Assembly Joint Without Seal	8	Joints that are open and not sealed. This element includes finger and sliding plate joints.
306	Other Joints	8	Joints that cannot be classified using any other defined joint element.

Quantity Calculation: Sum the lengths of all joints measured along the skew angle.

Element Commentary: Other Joints shall also include partial depth strip seal and block out style expansion joints.

2. APPROACH SLAB (SQ. FT.)

Description: These elements define structural sections, between the abutment and the approach pavement.

No.	Name	CS Table	Description
320	Prestressed Concrete Approach Slab	2	Prestressed (post-tensioned) reinforced concrete approach slabs.
321	Reinforced Concrete Approach Slab	1	Mild steel reinforced concrete approach slabs.

Quantity Calculation: The quantity for this element should include the area of the approach slab(s) from edge to edge including any median areas and accounting for any flares or ramps present. This includes the portion of link slabs and sleeper slabs that extend beyond the reference line.

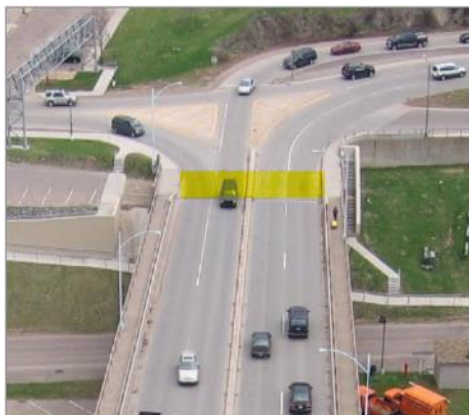

321 Reinforced Concrete Approach Slab

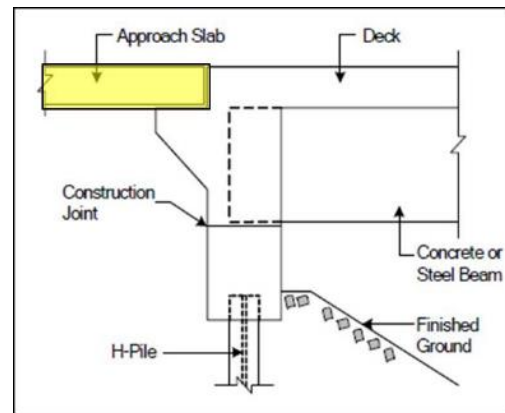

3. BRIDGE RAILING (FT.)

Description: These elements are for bridge rail, which may be fabricated from steel, other metal, concrete, masonry, and other materials.

No.	Name	CS Table	Description
330	Metal Bridge Railing	3	All types and shapes of metal bridge railing. Steel, aluminum, metal beam, rolled shapes, etc. will all be considered part of this element. Included in this element are the posts of metal, timber, concrete, masonry, blocking and curb. This includes thrie-beam retrofit.
331	Reinforced Concrete Bridge Railing	1	All types and shapes of reinforced concrete bridge railing. All elements of the railing (not including incidentals such as handrails or pedestrian fencing) must be concrete.
332	Timber Bridge Railing	4	All types and shapes of timber bridge railing. Included in this element are the posts of metal, timber, concrete, masonry, blocking and curb.
333	Other Bridge Railing	6	All types and shapes of bridge railing that cannot be classified using any other defined railing element.
334	Masonry Bridge Railing	5	All types and shapes of masonry, stone bridge railing. All elements of the railing must be masonry, stone.

Quantity Calculation: The quantity is the number of bridge barriers times the length of the bridge. The element quantity includes only the rail on the bridge from reference line to reference line.

Element Commentary: The number of rows of rail on a bridge is commonly two, one on each side of the bridge. In some cases, there may be more than two rows when you have a center median or protected pedestrian/bicycle lanes. See Section 7.2.5.1 of the BIGD. Regarding rail on culverts, see Section 7.2.5.2 of the BIGD.

4. SUPERSTRUCTURE

Superstructure elements described in this section transmit loads from decks to the substructure. These elements include girders, trusses, arches and floor systems. The floor systems include floor beams and stringers. Additional elements in this group include cables, gusset plates and pin and hanger assemblies. These elements do not include bracing components such as diaphragms, cross bracing or portal sway bracing.

Girder elements transmit the loads from the deck into the substructure. Elements listed include closed web (boxes) and open girders (I sections). The materials include steel, reinforced and prestressed concrete and timber.

Stringer elements are part of a floor system and transmit load from the deck into the floor system, such as floor beams. Floor beam elements are the intermediate transverse load carrying members and can be constructed from steel, concrete and timber.

Truss and Arch elements include materials of steel, concrete, timber and masonry; and are the main load carrying members for the span.

Miscellaneous superstructure elements include elements such as steel gusset plates and main and secondary cables.

GIRDERS (FT.)

Description: These elements transmit loads from the deck to the substructure. Elements listed include closed web (boxes) and open girders (I-sections) regardless of protective systems.

No.	Name	CS Table	Description
102	Steel Closed Web/Box Girder	3	Steel box girders or closed web girders.
104	Prestressed Concrete Closed Web/Box Girder	2	Pretensioned or post-tensioned concrete closed web girders. When there is no deck and traffic rides directly on the girders the top flange is rated using NBE #15 (see pg. N-4).
105	Reinforced Concrete Closed Web/Box Girder	1	Reinforced concrete box girder or closed web girders. When there is no deck and traffic rides directly on the girders, the top flange is rated using NBE #16 (see pg. N-4).
106	Other Closed Web/Box Girder	6	Composite material or other material box girders or closed web girders that cannot be classified using any other defined closed web/box girder element.
107	Steel Open Girder/Beam	3	Steel open girders.
109	Prestressed Concrete Open Girder/Beam	2	Pretensioned or post-tensioned concrete open web girders. When traffic rides directly on the girders, the top flange is rated using NBE #15 (see pg. N-4).
110	Reinforced Concrete Open Girder/Beam	1	Mild steel reinforced open web girders. When there is no deck and traffic rides directly on the girders, the top flange is rated using NBE #16 (see pg. N-4).
111	Timber Open Girder	4	All timber open girders.
112	Other Open Girder/Beam	6	Composite material girders and open girder/beams that cannot be classified using any other defined element. Includes concrete encased steel girders.

Quantity Calculation: The quantity for these elements is the sum of all lengths of each girder or girder section. This convention applies to all girders, channels, and box girders. The quantity is NOT dependent on the number of visible pairs of girder faces but is determined by the length of the bridge multiplied by the number of girders, beams, channels or box girders.

Element Commentary: The girder evaluation is three dimensional in nature with the defects observed on all exterior and interior (if visible) surfaces.

GIRDERS (FT.) (CONTINUED)

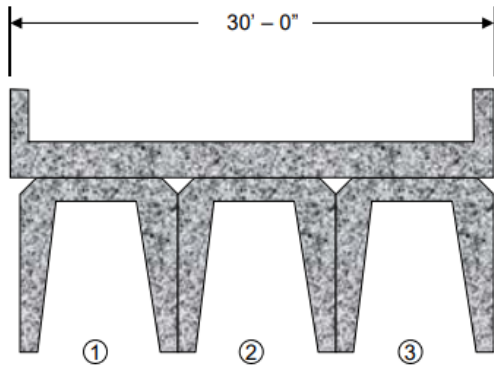

Since there are three (3) channel beams, the quantity should be the length of the bridge multiplied by 3. For the above figure a bridge that is 25 feet in length and 30 feet wide, the total girder quantity should be 75 feet.

Reinforced Concrete Deck (Element 12)

Quantity = 30 FT x 25 FT = 750 SF

Reinforced Concrete – Open Girder/Beam (Element 110)

Quantity = 25 LF x 3 = 75 LF

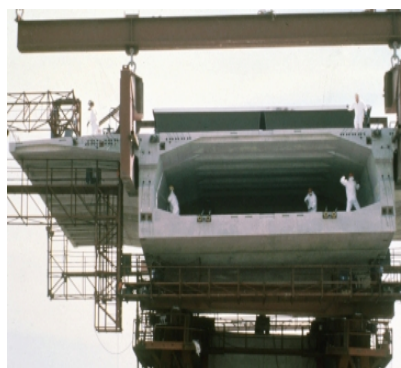

104 Prestressed Closed Web/Box Girder (Segmental)



109 Prestressed Concrete Open Girder (Precast Double T)

FLOOR BEAMS (FT.)

Description: This element defines only elements that transversely support stringers or decks, regardless of protective systems.

No.	Name	CS Table	Description
152	Steel Floor Beam	3	The condition evaluation for this element includes web faces and the top and bottom flange.
154	Prestressed Concrete Floor Beam	2	Only prestressed elements.
155	Reinforced Concrete Floor Beam	1	Only mild steel reinforced concrete.
156	Timber Floor Beam	4	Timber floor beams.
157	Other Floor Beam	6	Composite materials, or other materials that cannot be classified using any other defined elements.

Quantity Calculation: The quantity for these elements is the sum of all lengths of each floor beam.

Element Commentary: The floor beam evaluation is three dimensional in nature with the defects observed on all exterior surfaces.

STRINGERS (FT.)

Description: These superstructure elements transmit loads from the deck to the floor system, such as floor beams, regardless of protective systems. These elements define members that support the deck in a stringer floor beam system.

No.	Name	CS Table	Description
113	Steel Stringer	3	Steel members that support the deck in a stringer floor beam system.
115	Prestressed Concrete Stringer	2	Pretensioned or post-tensioned concrete members that support the deck in a stringer floor beam system.
116	Reinforced Concrete Stringer	1	Mild steel reinforced concrete members that support the deck in a stringer floor beam system.
117	Timber Stringer	4	Timber members that support the deck in a stringer floor beam system.
118	Other Stringer	6	Composite materials or other materials that cannot be classified using any other defined elements.

Quantity Calculation: The quantity for these elements is the sum of all lengths of each section.

Element Commentary: The stringer evaluation is three dimensional in nature with the defects observed on all exterior surfaces.

TRUSSES (FT.)

Description: This element defines all truss components, including all tension and compression members for through and deck trusses, regardless of protective system.

No.	Name	CS Table	Description
120	Steel Truss	3	Steel truss elements. See element 162 (Gusset Plate) for additional details.
135	Timber Truss	4	Timber truss elements.
136	Other Truss	6	Composite materials or those that cannot be classified by any other defined truss element.

Quantity Calculation: The quantity for this element is the sum of all of the lengths of each truss panel measured longitudinal along the traveled way. Observed distress in diagonal and vertical truss members shall be reported as the projected length along the length of the truss.

Element Commentary: Given their complexity, examples of trusses are included at the end of this appendix.



120 Steel Truss

ARCHES (FT.)

Description: This element defines arches regardless of materials type or protective system.

No.	Name	CS Table	Description
141	Steel Arch	3	Steel arches.
142	Other Arch	6	Composite materials and arches, regardless of type, that cannot be classified using any other defined arch element.
143	Prestressed Concrete Arch	2	Pretensioned or post-tensioned concrete arches.
144	Reinforced Concrete Arch	1	Mild steel reinforced concrete arches.
145	Masonry Arch	5	Masonry or stacked stone arches.
146	Timber Arch	4	Timber arches.

Quantity Calculation: The quantity for this element is the sum of the length of each arch horizontally between spring lines and measured longitudinal to the travel way. It is not measured along the length of the barrel. See example below. For filled arches, the arch quantity shall be measured from spring line to spring line. The length below the spring line is considered substructure.

Element Commentary: Observed distress in arch diagonals and vertical members (including spandrel columns) shall be reported as the projected length along the arch length. For Steel Through, Tied or Deck Arches there are no separate elements for verticals and diagonals. They shall be included in the arch element (like a truss). Also include other associated steel superstructure elements such as: girders, floor beams, stringers, cables, etc. For ‘Concrete Deck Arches – Covered With Fill’ see ‘Slab Spans - covered with fill’ at the end of this appendix.

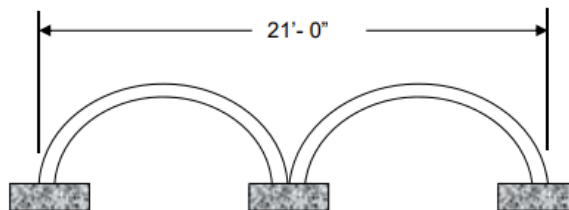

CABLES (SEE DESCRIPTION)

Description: This element defines cables regardless of material type, regardless of protective system.

No.	Name	CS Table	Description
147	Steel Main Cables	3	Steel main suspension or cable stay cables not embedded in concrete. This element is intended for use on main cables in suspension bridges or main cable stays in cable-stayed bridges. Suspender cables or other smaller cables shall be captured using the secondary cable element. The quantity for this element is the sum of all of the lengths of each main cable measured longitudinal to the travel way.
148	Secondary Steel Cables	3	Steel suspender cables not embedded in concrete. It is for all individual or cable groups. This element is intended for use on suspender cables, other smaller cables or groups of cables in one location acting as a system to carry loads from the superstructure to the main cable/arch. The quantity for this element is the sum of the individual cable or cable groups carrying the load from the superstructure to the main cable/arch elements.
149	Other Secondary Cables	6	Other material cables not embedded in concrete. It is for all individual other material cables or cable groups regardless of protective systems. The quantity for this element is the sum of the individual cable or cable groups carrying the load from the superstructure to the main cable/arch elements. The other material secondary cable is intended for cables of composite materials, or other materials that cannot be classified using any other defined cable elements.

Quantity Calculation: See descriptions above for quantity calculations specific to each.

MISCELLANEOUS SUPERSTRUCTURE ELEMENTS (EA.)

Description: This element defines miscellaneous superstructure elements that cannot be categorized according to any of the previously described categories regardless of material type and protective system.

No.	Name	CS Table	Description
161	Steel Pin and Pin & Hanger Assembly	3	Steel pin and hanger assemblies. Distress observed on either the pin, link plate, or web plate should be considered in the condition assessment. Ultrasonic testing results should be taken into consideration in the condition assessment if available. The quantity for this element is the sum of the number of pin and hanger assemblies.
162	Steel Gusset Plate	3	Only those steel gusset plate(s) connections that connect the main truss/arch panel(s). These connections can be constructed with one or more plates that may be bolted, riveted, or welded. The quantity for this element is the sum of the number of primary load path gusset plate assemblies. For multiple plate gusset connections at a single panel point, the quantity shall be one gusset plate assembly regardless of the number of individual plates at the single connection point.

Quantity Calculation: See description above for quantity calculations specific to each.

Element Commentary: The evaluation is three dimensional in nature with the defects observed on all exterior and interior (if visible) surfaces.

RIGID FRAMES AND THREE SIDED STRUCTURES (SEE DESCRIPTION)

Description: A steel frame shall be coded using Element 107 (Steel Open Girder/Beam).

No.	Name	CS Table	Description
107	Steel Open Girder/Beam	3	Steel open girders.

Quantity Calculation: The legs of the steel frame in this example are included in the overall length of the element ‘Steel Open Girder/Beam’. Any elements located above the bearings are part of the superstructure.

Element Commentary: The girder evaluation is three dimensional in nature with the defects observed on all exterior and interior (if visible) surfaces.

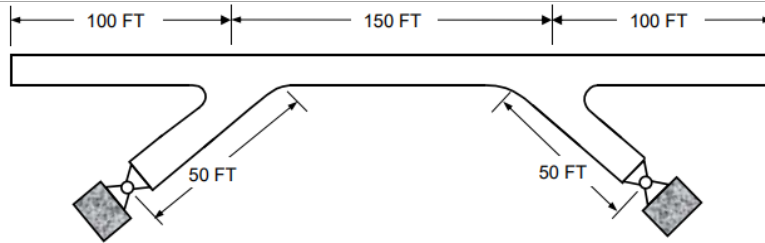

Steel Open Girder/Beam (Element 107)
Quantity = 450 LF (per girder line)

Description: A concrete frame shall be coded using Element 12 (Reinforced Concrete Deck) and Element 215 (Reinforced Concrete Abutment).

No.	Name	CS Table	Description
12	Reinforced Concrete	1	Reinforced concrete bridge decks
215	Reinforced Concrete Abutment	1	Mild steel reinforced concrete abutments including the sheet material retaining the embankment and wingwalls, abutment extensions, and any other monolithically placed concrete elements up to the first construction joint (cold joint, water stop, etc.).

Quantity Calculation: Concrete frames should be coded using the elements for reinforced concrete abutment and reinforced concrete deck. The abutment is calculated in linear feet and the deck is calculated in square feet.

Element Commentary: The quantity for abutment portion of the element is the sum of the width of the abutment with monolithic wingwalls and abutments extensions measured along the skew angle. The deck evaluation is three dimensional in nature with the defects observed on the top surface, bottom surface, edges or all; and being captured using the defined condition states. Deck top or bottom surfaces that are not visible for inspection shall be assessed based on the available visible surface. If both top and bottom surfaces are not visible, the condition shall be assessed based on destructive and nondestructive testing or indicators in the materials covering the surfaces. Both the severity and density of spalls, delaminations, or patched areas, and severity and density of cracks and the existence of rust staining should be considered for the evaluation of the deck elements.

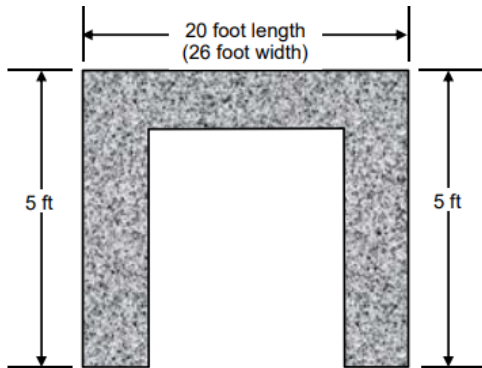

Reinforced Concrete Deck (Element 12)
Quantity = 20 FT x 26 FT = 520 SF

Reinforced Concrete Abutment (Element 215)
Quantity = 26 LF x 2 = 52 LF

5. WEARING SURFACES (SQ. FT.)

Description: This element defines the condition wearing surface, which is the protective coating for the deck element of a structure. Types of wearing surface include flexible (asphalt), semi-rigid (epoxy, polyester), rigid (concrete, latex, micro-silica or high performance cement) and timber planks. Inspectors will use element 510 to record the condition of the wearing surface. Note that NBI Item 108 is used only to record the type of wearing surface, not the condition.

No.	Name	CS Table	Description
510	Wearing Surface	7	This element is for the wearing surface, the protective coating for the deck element.

Quantity Calculation: The quantity for this element should include the entire area of wearing surface (or protective coating) for the element.

Element Commentary: The wearing surface evaluation should consider severity of the rutting, scaling, or wear in the wheel tracks. Also to be considered is the area of wearing surface debondment, such as pot holes or pan holes. For something to be called a wearing surface, it must be placed separately from the time the deck is placed. This is the first and most important test. Therefore, monolithically place concrete (the 1/4" that designers call a wearing surface) is not a wearing surface. The following are examples of wearing surfaces: asphaltic concrete overlays, cementitious overlays and epoxy overlays. There are others not mentioned here.

6. PROTECTIVE COATING (SQ. FT.)

Description: These elements define protective coatings including paint, oxide on weathering steel, cathodic protection, topcoat corrosion inhibitor and galvanization that influence the deterioration and condition of the underlying structural element.

No.	Name	CS Table	Description
515	Steel Protective Coating	10	This element is for steel elements that have a corrosion inhibiting protective coating.
521	Concrete Protective Coating	10	This element is for concrete elements that have a protective coating. These coatings include silane/siloxane water proofers, crack sealers such as High Molecular Weight Methacrylate (HMWM), or any topcoat barrier that protects concrete from deterioration and reinforcing steel from corrosion.

Quantity Calculation: The quantity for this element should include the entire area of protected surface for the element. The steel protective coating for superstructure elements for superstructure elements will be calculated by first determining the visible surface area of the primary structural elements (i.e. the top face of top flange is excluded) then adding 10% to account for secondary members such as diaphragms, web stiffeners, bearing stiffeners, etc.



515 Steel Protective Coating



521 Concrete Protective Coating

7. BEARINGS (EA.)

Description: These elements define bridge bearings.

No.	Name	CS Table	Description
310	Elastomeric Bearing	9	This element defines bridge bearings that are constructed primarily of elastomers, with or without fabric or metal reinforcement.
311	Moveable Bearing	9	This element defines bridge bearings that provide for both rotation and longitudinal movement by means of roller, rocker, or sliding mechanisms.
312	Enclosed/Concealed Bearing	9	This element defines bridge bearings that are enclosed so that they are not open for detailed inspection. This element should be used for box girder hinges. In cases where the bearing material is not visible, the inspector shall assess the condition based on alignment, grade across the joint, persistence of debris, or other indirect indicators of the condition.
313	Fixed Bearing	9	This element defines bridge bearings that provide for rotation only (no longitudinal movement).
314	Pot Bearing	9	This element defines high load bearings with confined elastomer. The bearing may be fixed against horizontal movement, guided to allow sliding in one direction, or floating to allow sliding in any direction.
315	Disc Bearing	9	This element defines high load bearings with a hard plastic disk. This bearing may be fixed against horizontal movement, guided to allow movement in one direction, or floating to allow sliding in any direction.
316	Other Bearing	9	This element defines other material bridge bearings, regardless of translation or rotation constraints, that cannot be classified by any other defined bearing element.

Quantity Calculation: The quantity is the sum of each bearing type.

8. SUBSTRUCTURE

Substructure elements described in this section transmit loads from superstructure into the ground. These are the supporting elements of the structure and include columns, piles, pile extensions, pier walls, towers, trestles and abutments. These elements include elements of steel, concrete, timber, masonry, and other material.



215 Reinforced Concrete Abutment



210 Reinforced Concrete Pier Wall



207 Steel Tower

ABUTMENT (FT.)

Description: These elements define abutments, regardless of protective system.

No.	Name	CS Table	Description
215	Reinforced Concrete Abutment	1	Mild steel reinforced concrete abutments including the sheet material retaining the embankment and wingwalls, abutment extensions, and any other monolithically placed concrete elements up to the first construction joint (cold joint, water stop, etc.).
216	Timber Abutment	4	Timber abutments including the sheet material retaining the embankment and wingwalls, abutment extensions, and any other monolithically placed concrete elements up to the first construction joint (plank butt joint, etc.).
217	Masonry Abutment	5	Abutments constructed of block or stone placed with or without mortar.
218	Other Abutment	6	Other material abutment systems that cannot be classified by any other defined abutment element, including the sheet material retaining the embankment and wingwalls, abutment extensions.
219	Steel Abutment	3	Steel abutments including the sheet material retaining the embankment and wingwalls, and abutment extensions

Quantity Calculation: The quantity for these elements are the sum of the width of the abutment with monolithic wingwalls and abutments extensions measured along the skew angle. Wingwalls that are not monolithic with the abutment shall not be included in the abutment or assessment of the abutment element.

Element Commentary: Spill-through abutments are common in South Carolina. See below.

SPILL-THROUGH ABUTMENT (SEE BELOW)

Quantity Calculation: If the columns are visible, the abutment should be coded as indicated below. If the columns are present but not directly visible, reasonable efforts should be made to observe the columns. If the columns are still not visible the Element should be coded and the condition state should be coded by other criteria. Destructive or non-destructive testing is not necessarily needed.

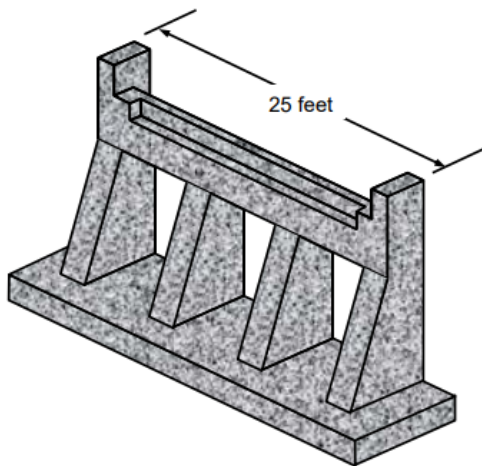

Reinforced Concrete Column (Element 205)
Quantity = 4 EA

Reinforced Concrete Pier Cap (Element 234)
Quantity = 25 LF

COLUMN (EA.)

Description: These elements define all columns, regardless of protective system.

No.	Name	CS Table	Description
202	Steel Column	3	Steel columns.
203	Other Column	6	Other material columns that cannot be classified using any other defined column element.
204	Prestressed Concrete Column	2	Prestressed concrete columns.
205	Reinforced Concrete Column	1	Reinforced concrete columns.
206	Timber Column	4	Timber columns.

Quantity Calculation: The quantity for these elements is the sum of the number of columns. Column elements are used for widths less than 10 feet. Columns shall bear on a footing, mudsill or other generally shallow foundation; unlike piles which bear on nothing and rely on friction. See Section 7.2.5.3 of the BIGD.

PIER WALL (FT.)

Description: This element defines pier walls, regardless of protective system.

No.	Name	CS Table	Description
210	Reinforced Concrete Pier Wall	1	Mild steel reinforced concrete pier walls.
211	Other Pier Wall	6	Other materials that cannot be classified by any other defined pier wall element.
212	Timber Pier Wall	4	Timber pier walls that include pile, timber sheet material, and filler.
213	Masonry Pier Wall	5	Block or stone placed with or without mortar.

Quantity Calculation: The quantity for this element is the sum of the lengths of the pier walls measured along the skew angle. Pier Wall elements are used for widths greater than 10 feet.

PIER CAP (FT.)

Description: These elements define pier caps that support girders and transfer loads to piles or columns, regardless of protective systems.

No.	Name	CS Table	Description
231	Steel Pier Cap	3	Steel pier caps.
233	Prestressed Concrete Pier Cap	2	Prestressed concrete pier caps.
234	Reinforced Concrete Pier Cap	1	Reinforced concrete pier caps.
235	Timber Pier Cap	4	Timber pier caps.
236	Other Pier Cap	6	Other material pier caps that cannot be classified using any other defined pier cap element.

Quantity Calculation: The quantity for this element is the sum of the lengths of the pier caps measured along the skew angle.

Element Commentary: Pier caps shall include mudsills (if visible).

PILE (EA.)

Description: These elements define all piles, regardless of protective system.

No.	Name	CS Table	Description
225	Steel Pile	3	Steel piles.
226	Prestressed Concrete Pile	2	Prestressed concrete piles.
227	Reinforced Concrete Pile	1	Reinforced concrete piles.
228	Timber Pile	4	Timber piles.
229	Other Pile	6	Composite materials or piles that cannot be classified by any other defined pile element.

Quantity Calculation: The quantity for these elements is the sum of the number of piles visible for inspection.

Element Commentary: Piles exposed from erosion or scour or visible during an underwater inspection are included in this element. Piles shall bear on nothing and rely on friction; unlike columns which bear on a footing, mudsill or other generally shallow foundation. See Section 7.2.5.3 of the BIGD.

PILE CAP/FOOTING (FT.)

Description: This element defines prestressed concrete pier caps and culverts.

No.	Name	CS Table	Description
220	Reinforced Concrete Pile Cap/Footing	1	Reinforced concrete pile caps/footings that are visible for inspection.

Quantity Calculation: The quantity for these elements is the sum of the length of pile caps/footings.

Element Commentary: Pile Caps or Footings exposed from erosion, scour, or visible during an underwater inspection are included in this element.

TOWER (FT.)

Description: This element defines built up steel truss or framed tower supports, and is for all towers regardless of protective system.

No.	Name	CS Table	Description
207	Steel Tower	3	This element is steel built up or framed tower supports, is for all towers, and is intended to capture large supports and towers associated with suspension bridges, cable stayed bridges, moveable bridges or similar structural configurations.

Quantity Calculation: The quantity for this element is the sum of the heights of built up or framed tower supports.

TRESTLE (FT.)

Description: This element defines framed timber supports, regardless of protective system.

No.	Name	CS Table	Description
208	Timber Trestle	4	This element defines framed timber supports, and is intended to be used for truss-framed trestles or towers. This element is intended to capture large supports and towers associated with large deck truss bridges.

Quantity Calculation: The quantity for this element is the sum of the heights of built up or framed tower supports.

9. CULVERT

A culvert is a structure designed hydraulically to take advantage of submergence to increase water carrying capacity. Culverts, as distinguished from bridges, are usually covered with embankment and are composed of structural material around the entire perimeter. Some culverts are supported on spread footings with the streambed serving as the bottom of the culvert.

Description: These elements define all culverts, regardless of protective system, including box, arched, round, or elliptical shapes.

No.	Name	CS Table	Description
240	Steel Culvert	3	Steel culverts, including arched, round or elliptical pipes.
241	Reinforced Concrete Culvert	1	Reinforced concrete culverts, includes 4-sided boxes.
242	Timber Culvert	4	Timber culverts.
243	Other Culvert	6	Other material culverts that cannot be classified using any other defined culvert element.
244	Masonry Culvert	5	Masonry block or stone culverts.
245	Prestressed Concrete Culvert	2	Prestressed concrete culverts.

Quantity Calculation: The quantity for these are collected in feet unless otherwise noted. The culvert element is measured along the flow line of the barrel times the number of barrels.

Element Commentary: The distortion defect is contingent on a number of factors such as site, wall thickness, fill depth, etc.

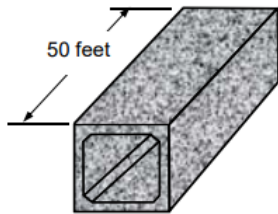

Reinforced Concrete Box Culvert (Element #241)
Quantity = 50 LF

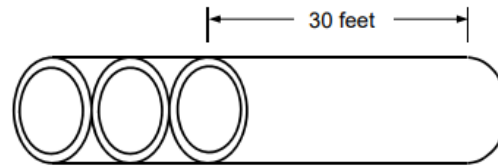

Metal Pipe Culvert (Element #240)
Quantity = 30 LF x 3 barrels = 90 LF



3-Sided Concrete Box Culvert

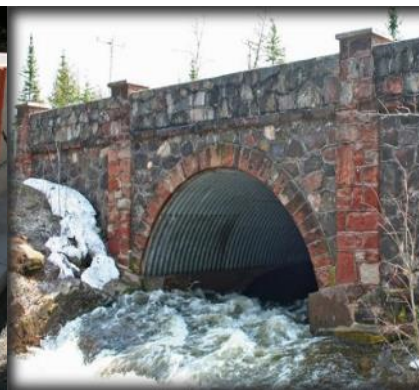

Corrugated Metal Pipe Arch Culvert



Masonry Culvert

10. CONDITION STATE TABLES

The condition state descriptions for National Bridge Elements and Bridge Management Elements follows guidance provided by the *AASHTO Manual for Bridge Element Inspection* and the FHWA. This appendix attempts to cover the majority of all conditions observed in the field, but during the course of an inspection, the inspector may find conditions that are not described. In these cases, the inspector should use the general description of the condition states to determine the appropriate condition. Overarching descriptors for the four condition states are as follows:

Condition State 1 (Good) – that portion of the element that has either no deterioration or the deterioration is insignificant to the management of the element, meaning that portion of the element has no condition based preventive maintenance needs or repairs. Areas of an element that have received long lasting structural repairs that restore the full capacity of the element with an expected life expectancy equal to the original element can be coded as good condition.

Condition State 2 (Fair) – that portion of the element that has minor deficiencies that signifies a progression of the deterioration process. This portion of the element may need condition based preventive maintenance. Areas of the element that have received structural repairs that improve the element, but the repair is not considered equal to the original member can be coded as fair.

Condition State 3 (Poor) – that portion of the element that has advanced deterioration requiring repair. The summation of the quantity of the element in poor or worse condition determines the need for repairs, rehabilitation, or replacement activities.

Condition State 4 (Severe) – that portion of the element that warrants a review to determine the effect on strength or serviceability of the element or bridge; OR a structural review has been completed and the defects impact strength or serviceability of the element or bridge. Elements with a portion or all of the quantity in state 4 may often have load capacity implications warranting a structural review. Within this appendix, the term structural review is defined as a review by a person qualified to evaluate the field observed conditions and make a determination of the impacts of the conditions on the performance of the element. Structural reviews may include a review of the field inspection notes and photographs, review of as-built plans or analysis as deemed appropriate to evaluate the performance of the element.

CS TABLE 1 – REINFORCED CONCRETE

Defect	Condition State 1	Condition State 2	Condition State 3	Condition State 4
	GOOD	FAIR	POOR	SEVERE
Spalls/ Delaminations/ Patch Areas (1080) ^{(2) (3)}	None.	Delaminated. Spall 1 in. or less deep or less than 6 in. diameter. Patched area is sound.	Spall greater than 1 in. deep or greater than 6 in. diameter. Patched area is unsound or showing distress. Does not warrant structural review.	The condition warrants a structural review to determine the effect on strength or serviceability of the element or bridge; OR a structural review has been completed and the defects impact strength or serviceability of the element or bridge.
Exposed Rebar (1090) ^{(2) (3)}	None.	Present without section loss.	Present with section loss that does not warrant structural review.	
Efflorescence/ Rust Staining (1120) ^{(2) (3)}	None.	Surface white without build-up or leaching without rust staining.	Heavy build-up with rust staining.	
Cracking ⁽¹⁾ Reinforced Concrete and Other (1130) ^{(2) (3)}	Insignificant cracks or moderate-width cracks that have been sealed.	Unsealed moderate-width cracks or unsealed moderate pattern (map) cracking.	Wide cracks or heavy pattern (map) cracking.	
Abrasion /Wear (1190)	No Abrasion of wearing	Abrasion or wearing has exposed coarse aggregate	Coarse aggregate is loose or has popped out of the concrete matrix due to abrasion or wear.	
Distortion – Culvert (1900)	None.	Distortion not requiring mitigation or mitigated distortion.	Distortion that requires mitigation but does not require structural review.	
Settlement – Substructure Elements (4000) ⁽³⁾	None.	Exists within tolerable limits or arrested with effective actions taken to mitigate.	Exceeds tolerable limits but does not warrant structural review.	
Scour – Substructure / Culvert Elements (6000) ⁽³⁾	None.	Exists within tolerable limits or arrested with effective countermeasures. See Section 13.	Exceeds tolerable limits but is less than the limits determined by scour evaluation, and does not warrant structural review. See Section 13.	
Damage (7000) ^{(2) (3)}	Not applicable.	The element has minor damage caused by vehicular or vessel impact.	The element has moderate damage caused by vehicular or vessel impact.	The element has severe damage caused by impact.

- (1) The inspector should use judgment when utilizing the condition state defect conditions, especially for concrete cracking. The crack defect description definitions describe generalized distress, but the inspector should consider width, spacing, location, orientation, and structure or nonstructural nature of the cracking. The inspector should consider exposure and environment when evaluating crack width. In general, reinforced concrete cracks less than 0.012 inches can be considered insignificant and a defect is not warranted. Cracks ranging from 0.012 to 0.05 inches can be considered moderate, and cracks greater than 0.05 inches can be considered wide.
- (2) If a saddle is present because of the indicated defect, the inspector shall consider the saddle’s installation during the element-level assessment. See Section 7.2.5.6 of the BIGD.
- (3) If a pile repair (such as a splice or stud-up) is present because of the indicated defect, the inspector shall consider the repair during the element-level assessment. See Section 7.2.5.5 of the BIGD.



Condition State 2



Condition State 3



Condition State 4

CS TABLE 1 – REINFORCED CONCRETE (Continued)



Condition State 2



Condition State 3



Condition State 4



Condition State 2



Condition State 3



Condition State 4

CS TABLE 1 – REINFORCED CONCRETE – DEFECT SPECIFIC PHOTOGRAPHS



(1080 – Delamination/Spall/Patched Area)
Condition State 2



(1080 – Delamination/Spall/Patched Area)
Condition State 3



(1090 – Exposed Rebar)
Condition State 2



(1090 – Exposed Rebar)
Condition State 3

CS TABLE 1 – REINFORCED CONCRETE – DEFECT SPECIFIC PHOTOGRAPHS (Continued)



(1120 – Efflorescence/Rust Staining)
Condition State 2



(1120 – Efflorescence/Rust Staining)
Condition State 3



(1130 – Cracking/RC and Other)
Condition State 2

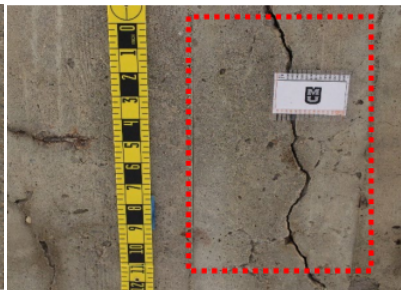

(1130 – Cracking/RC and Other)
Condition State 3

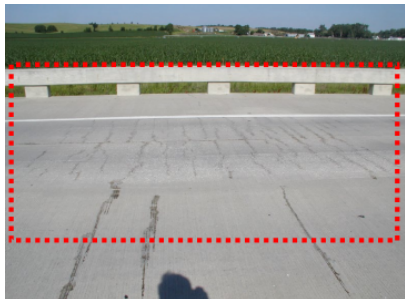

(1130 – Cracking/RC and Other)
Condition State 2



(1130 – Cracking/RC and Other)
Condition State 3

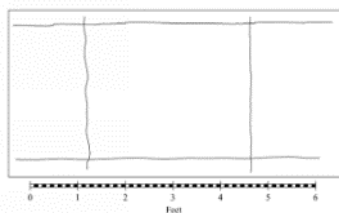

(Crack Pattern Guide)
Condition State 1

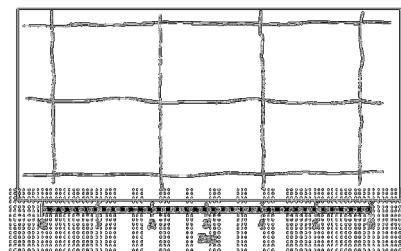

(Crack Pattern Guide)
Condition State 2

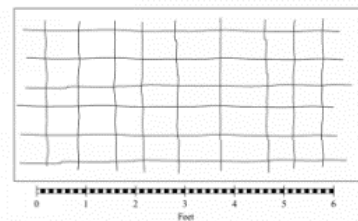

(Crack Pattern Guide)
Condition State 3

**CS TABLE 1 – REINFORCED CONCRETE – DEFECT SPECIFIC PHOTOGRAPHS
(Continued)**



(1190 – Abrasion/Wear)
Condition State 2



(1190 – Abrasion/Wear)
Condition State 3

CS TABLE 2 – PRESTRESSED CONCRETE

Defects	Condition State 1	Condition State 2	Condition State 3	Condition State 4
	GOOD	FAIR	POOR	SEVERE
Spalls/ Delaminations/ Patch Areas (1080) ^{(2) (3)}	None.	Delaminated. Spall 1 in. or less deep or less than 6 in. diameter. Patched area is sound.	Spall greater than 1 in. deep or greater than 6 in. diameter. Patched area is unsound or showing distress. Does not warrant structural review.	The condition warrants a structural review to determine the effect on strength or serviceability of the element or bridge; OR a structural review has been completed and the defects impact strength or serviceability of the element or bridge.
Exposed Rebar (1090) ^{(2) (3)}	None.	Present without section loss.	Present with section loss that does not warrant structural review.	
Exposed Prestressing (1100) ^{(2) (3)}	None.	Present without section loss.	Present with section loss that does not warrant structural review.	
Cracking ⁽¹⁾ PSC (1110) ^{(2) (3)}	Insignificant cracks or moderate-width cracks that have been sealed.	Unsealed moderate-width cracks or unsealed moderate pattern (map) cracking.	Wide cracks or heavy pattern (map) cracking.	
Efflorescence / Rust Staining (1120) ^{(2) (3)}	None.	Surface white without build-up or leaching without rust staining.	Heavy build-up with rust staining.	
Settlement - Substructure (4000) ⁽³⁾	None.	Exists within tolerable limits or arrested with effective actions taken to mitigate.	Exceeds tolerable limits but does not warrant structural review.	
Scour – Substructure / Culvert Elements (6000) ⁽³⁾	None.	Exists within tolerable limits or arrested with effective countermeasures. See Section 13.	Exceeds tolerable limits but is less than the limits determined by scour evaluation, and does not warrant structural review. See Section 13.	
Damage (7000) ^{(2) (3)}	Not applicable.	The element has minor damage caused by vehicular or vessel impact.	The element has moderate damage caused by vehicular or vessel impact.	The element has severe damage caused by vehicular or vessel impact.

- (1) The inspector should use judgment when utilizing the condition state defect conditions, especially for concrete cracking. The crack defect description definitions describe generalized distress, but the inspector should consider width, spacing, location, orientation, and structure or nonstructural nature of the cracking. The inspector should consider exposure and environment when evaluating crack width. In general, reinforced concrete cracks less than 0.004 inches can be considered insignificant and a defect is not warranted. Cracks ranging from 0.004 to 0.009 inches can be considered moderate, and cracks greater than 0.009 inches can be considered wide.
- (2) If a saddle is present because of the indicated defect, the inspector shall consider the saddle’s installation during the element-level assessment. See Section 7.2.5.6 of the BIGD.
- (3) If a pile repair (such as a splice or stud-up) is present because of the indicated defect, the inspector shall consider the repair during the element-level assessment. See Section 7.2.5.5 of the BIGD.



Condition State 2



Condition State 3



Condition State 4

CS TABLE 2 – PRESTRESSED CONCRETE – DEFECT SPECIFIC PHOTOGRAPHS



(1110 – Cracking/PSC)
Condition State 2

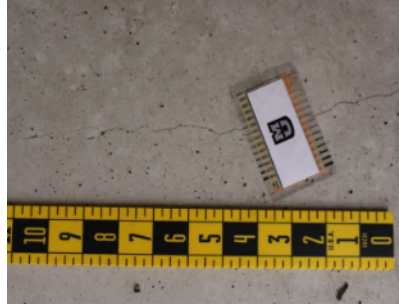

(1110 – Cracking/PSC)
Condition State 3

CS TABLE 3 - STEEL

	Condition State 1	Condition State 2	Condition State 3	Condition State 4
Defects	GOOD	FAIR	POOR	SEVERE
Corrosion (1000) ^{(1) (2)}	None.	Freckled Rust. Corrosion of the steel has initiated.	Section loss is evident or pack rust is present but does not warrant structural review.	The condition warrants a structural review to determine the effect on strength or serviceability of the element or bridge; OR a structural review has been completed and the defects impact strength or serviceability of the element or bridge.
Cracking/Fatigue (1010) ^{(1) (2)}	None.	Cracks that have self-arrested or have been arrested with effective arrest holes, doubling plates or similar.	Identified cracks exist that are not arrested and do not require structural review.	
Connections (1020) ^{(1) (2)}	Connection is in place and functioning as intended.	Loose fasteners or pack rust without distortion is present but the connection is in place and functioning as intended.	Missing bolts, rivets, broken welds, fasteners or pack rust with distortion but do not warrant a structural review.	
Distortion (1900) ^{(1) (2)}	None.	Distortion not requiring mitigation or mitigated distortion.	Distortion that requires mitigation but does not require structural review.	
Settlement – Substructure Elements (4000) ⁽²⁾	None.	Exists within tolerable limits or arrested with effective actions taken to mitigate.	Exceeds tolerable limits but does not warrant structural review.	
Scour – Substructure / Culvert Elements (6000) ⁽²⁾	None.	Exists within tolerable limits or arrested with effective countermeasures. See Section 13.	Exceeds tolerable limits but is less than the limits determined by scour evaluation, and does not warrant structural review. See Section 13.	
Damage (7000) ^{(1) (2)}	Not applicable.	The element has minor damage caused by vehicular or vessel impact.	The element has moderate damage caused by vehicular or vessel impact.	The element has severe damage caused by vehicular or vessel impact.

- (1) If a saddle is present because of the indicated defect, the inspector shall consider the saddle’s installation during the element-level assessment. See Section 7.2.5.6 of the BIGD.
- (2) If a pile repair (such as a splice or stud-up) is present because of the indicated defect, the inspector shall consider the repair during the element-level assessment. See Section 7.2.5.5 of the BIGD.



Condition State 2 (Damage)

Condition State 3 (Damage)

Condition State 4 (Damage)

CS TABLE 3 – STEEL (Continued)



(1000 – Corrosion)
Condition State 4



(1000 – Corrosion)
Condition State 3



(1000 – Corrosion)
Condition State 4



(1000 – Corrosion)
Condition State 2



(1000 – Corrosion)
Condition State 3



(1020 – Connections)
Condition State 2



(1020 – Connections)
Condition State 3



(1020 – Connections)
Condition State 4



(1020 – Connections)
Condition State 2

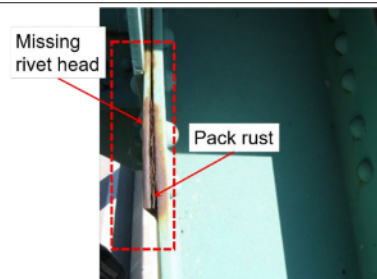

(1020 – Connections)
Condition State 3

CS TABLE 3 – STEEL (Continued)



(1010 – Cracking)
Condition State 2



(1010 – Cracking)
Condition State 3



(1010 – Cracking)
Condition State 4



(1010 – Cracking)
Condition State 2

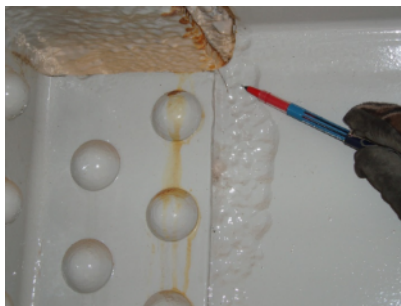

(1010 – Cracking)
Condition State 3

CS TABLE 4 – TIMBER

The condition of all diagonal/cross bracing on substructure units should be considered in rating the condition of the appropriate substructure unit (piles, etc.). In the event that the bracing is deteriorated, deteriorated section of bracing should be considered to be part of the nearest appropriate substructure unit (piles, etc.). Considering the Timber Bent shown below, if there was no decay of the piles, but there was decay of the cross bracing with no loss of strength or indication of deflection, then the Element 206 should be placed in CS2. Timber columns are used because this example assumes the timber columns are bearing on a shallow foundation. Typically coded as 3 different elements: a timber cap, timber columns, and a timber abutment. The timber abutment in these cases will consist only of the timber lagging of the abutment.

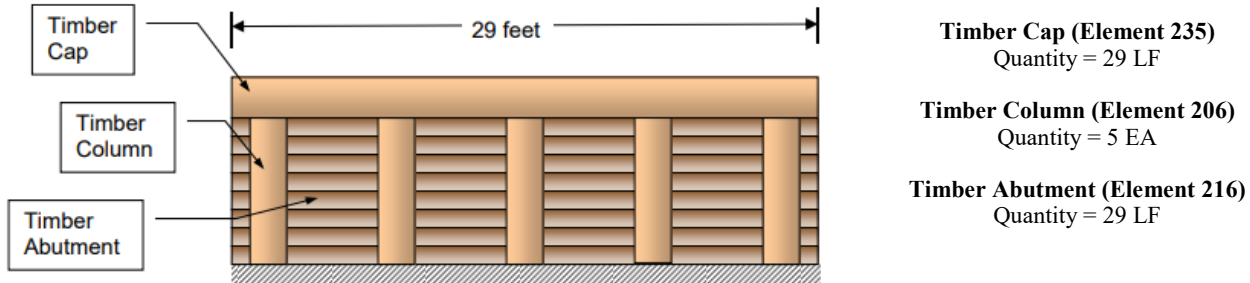

	Condition State 1	Condition State 2	Condition State 3	Condition State 4
Defects	GOOD	FAIR	POOR	SEVERE
Decay/ Section Loss (1140) ^{(1) (2)}	None.	Affects less than 10% of the member section	Affects 10% or more of the member but does not warrant structural review.	The condition warrants a structural review to determine the effect on strength or serviceability of the element or bridge; OR a structural review has been completed and the defects impact strength or serviceability of the element or bridge.
Checks/ Shakes (1150) ^{(1) (2)}	Surface penetration less than 5% of the member thickness regardless of location.	Penetrates 5% - 50% of the thickness of the member and not in a tension zone.	Penetrates more than 50% of the thickness of the member or more than 5% of the member thickness in a tension zone. Does not warrant structural analysis.	
Cracks - Timber (1160) ^{(1) (2)}	None.	Cracks that have been arrested through effective measures.	Identified cracks exist that are not arrested and do not require structural review.	
Splits/ Delamination - Timber (1170) ^{(1) (2)}	None.	Length less than the member depth or arrested with effective actions taken to mitigate.	Length greater than the member depth and does not require structural review.	
Abrasion (1180) ^{(1) (2)}	None or no measurable section loss.	Section loss less than 10% of the member thickness.	Section loss 10% or more of the member thickness but does not warrant structural review.	
Scour – Substructure Elements (6000) ⁽²⁾	None.	Exists within tolerable limits or arrested with effective countermeasures. See Section 13.	Exceeds tolerable limits but is less than the limits determined by scour evaluation, and does not warrant structural review. See Section 13.	
Damage (7000) ^{(1) (2))}	Not applicable.	The element has minor damage caused by vehicular or vessel impact.	The element has moderate damage caused by vehicular or vessel impact.	The element has severe damage caused by impact

- (1) If a saddle is present because of the indicated defect, the inspector shall consider the saddle’s installation during the element-level assessment. See Section 7.2.5.6 of the BIGD.
- (2) If a pile repair (such as a splice or stud-up) is present because of the indicated defect, the inspector shall consider the repair during the element-level assessment. See Section 7.2.5.5 of the BIGD.

CS TABLE 4 – TIMBER – DEFECT SPECIFIC PHOTOGRAPHS



(1140 – Decay/Section Loss)
Condition State 3*



(1140 – Decay/Section Loss)
Condition State 4

* A stud-up repair is present. However, the water line is below the repair. The repair is generally ineffective; however, a structural review or repair is not needed. Therefore, place in CS 3 since greater than 10% of the pile is decayed and the repair is generally ineffective. See Note 2 on previous page and BIGD Section 7.2.2.5.

CS TABLE 5 – MASONRY

	Condition State 1	Condition State 2	Condition State 3	Condition State 4
Defects	GOOD	FAIR	POOR	SEVERE
Spalls/ Delaminations/ Patch Areas (1080)	None.	Delaminated. Spall 1 in. or less deep or less than 6 in. diameter. Patched area is sound.	Spall greater than 1 in. deep or greater than 6 in. diameter. Patched area is unsound or showing distress. Does not warrant structural review.	The condition warrants a structural review to determine the effect on strength or serviceability of the element or bridge; OR a structural review has been completed and the defects impact strength or serviceability of the element or bridge.
Efflorescence (1120)	None.	Surface white without build-up or leaching without rust staining.	Heavy build-up with rust staining.	
Mortar Breakdown - Masonry (1610)	None.	Cracking or voids in less than 10% of joints.	Cracking or voids in 10% or more of the joints.	
Splits or Spalls - Masonry (1620)	None.	Block or stone has split or spalled with no shifting.	Block or stone has split or spalled with shifting but does not warrant a structural review.	
Patched Areas -Masonry (1630)	None.	Sound patches.	Unsound patches.	
Masonry Displacement (1640)	None.	Block or stone has shifted slightly out of alignment.	Block or stone has shifted significantly out of alignment or is missing but does not warrant structural review.	
Scour – Substructure Elements (6000)	None.	Exists within tolerable limits or arrested with effective countermeasures. See Section 13.	Exceeds tolerable limits but is less than the limits determined by scour evaluation, and does not warrant structural review. See Section 13.	
Damage (7000)	Not applicable.	The element has minor damage caused by vehicular or vessel impact.	The element has moderate damage caused by vehicular or vessel impact.	The element has severe damage caused by vehicular or vessel impact.

CS TABLE 6 – OTHER MATERIALS

	Condition State 1	Condition State 2	Condition State 3	Condition State 4
Defects	GOOD	FAIR	POOR	SEVERE
Corrosion (1000)	None.	Freckled rust. Corrosion of the steel has initiated.	Section loss is evident or pack rust is present but does not warrant structural review.	The condition warrants a structural review to determine the effect on strength or serviceability of the element or bridge; OR a structural review has been completed and the defects impact strength or serviceability of the element or bridge.
Cracking/Fatigue (1010)	None.	Cracks that have self-arrested or that have been arrested with effective arrest holes, doubling plates, or similar.	Identified cracks exist that are not arrested and do not require structural review.	
Connections (1020)	Connection is in place and functioning as intended.	Loose fasteners or pack rust without distortion is present but the connection is in place and functioning as intended.	Missing bolts, rivets, broken welds, fasteners or pack rust with distortion but do not warrant a structural review.	
Spalls/ Delaminations/ Patch Areas (1080)	None.	Delaminated. Spall 1 in. or less deep or less than 6 in. diameter. Patched area is sound.	Spall greater than 1 in. deep or greater than 6 in. diameter. Patched area is unsound or showing distress. Does not warrant structural review.	
Efflorescence / Rust Staining (1120)	None.	Surface white without build-up or leaching without rust staining.	Heavy build-up with rust staining.	
Cracking ⁽¹⁾ Reinforced Concrete and Other (1130)	Insignificant cracks or moderate-width cracks that have been sealed	Unsealed moderate-width cracks or unsealed moderate pattern (map) cracking.	Wide cracks or heavy pattern (map) cracking.	
Deterioration (Other) (1220)	None.	Initiated breakdown or deterioration.	Significant deterioration or breakdown that does not warrant structural review.	
Damage (7000)	Not applicable.	The element has minor damage caused by vehicular or vessel impact.	The element has moderate damage caused by vehicular or vessel impact.	The element has severe damage caused by vehicular or vessel impact.

(1) The inspector should use judgment when utilizing the condition state defect conditions, especially for concrete cracking. The crack defect description definitions describe generalized distress, but the inspector should consider width, spacing, location, orientation, and structure or nonstructural nature of the cracking. The inspector should consider exposure and environment when evaluating crack width. In general, reinforced concrete cracks less than 0.012 inches can be considered insignificant and a defect is not warranted. Cracks ranging from 0.012 to 0.05 inches can be considered moderate, and cracks greater than 0.05 inches can be considered wide.

CS TABLE 7 – WEARING SURFACES

	Condition State 1	Condition State 2	Condition State 3	Condition State 4
Defects	GOOD	FAIR	POOR	SEVERE
Spalls/ Delaminations/ Patch Areas/ Potholes (3210)	None.	Delaminations. Spalls 1 in. or less deep or less than 6 in. in diameter. Patched areas are sound. Partial depth potholes.	Spalls greater than 1 in. deep or greater than 6 in. in diameter. Patched areas are unsound or showing distress. Full depth potholes.	The wearing surface is no longer effective.
Cracks (3220)	Widths less than 0.012 in. or spacing greater than 3.0 ft.	Widths 0.012–0.05 in. or spacing of 1.0–3.0 ft.	Widths of more than 0.05 in. or spacing of less than 1.0 ft.	
Effectiveness (3230)	Fully effective. No evidence of leakage or further deterioration of the protected element.	Substantially effective. Deterioration of the protected element has slowed.	Limited effectiveness. Deterioration of the protected element has progressed.	
Damage (7000)	Not applicable	The element has minor damage caused by vehicular or vessel impact.	The element has moderate damage caused by vehicular or vessel impact.	The element has severe damage caused by vehicular or vessel impact.

CS TABLE 8 – JOINTS

	Condition State 1	Condition State 2	Condition State 3	Condition State 4
Defects	GOOD	FAIR	POOR	SEVERE
Leakage (2310)	None.	Minimal. Minor dripping through the joint.	Moderate. More than a drip and less than free flow of water.	Free flow of water through the joint.
Seal Adhesion – Joints with Seals Only (2320)	Fully adhered.	Adhered for more than 50% of the joint height.	Adhered 50% or less of joint height but still some adhesion.	Complete loss of adhesion.
Seal Damage – Joints with Seals Only (2330)	None.	Seal abrasion without punctures.	Punctured, ripped or partially pulled out.	Punctured completely through, pulled out, or missing.
Seal Cracking – Joints with Seals Only (2340)	None.	Surface cracks.	Cracks that partially penetrate the seal.	Cracks that fully penetrate the seal.
Debris Impaction (2350)	None.	Partially filled, but still allowing free movement.	Completely filled and impacts joint movement.	Completely filled and prevents joint movement.
Adjacent Deck or Header (2360)	Sound. No spalls, delamination or unsound patches.	Edge delamination or spall less than 1 in. deep or less than 6 in. diameter. No exposed rebar. Patched area is sound.	Spall greater than 1 in. deep or greater than 6 in. diameter. Exposed rebar. Delamination or unsound patched area that makes the joint loose.	Spall, delamination, unsound patched area or loose joint anchor that impacts joint performance.
Metal Damage (2370)	None.	Freckled rust, metal has no cracks or impact damage. Connections may be loose but functioning as intended.	Section loss, missing or broken fasteners, cracking of the metal or impact damage but joint still functioning.	Extensive metal cracking, section loss damage or connection failures impacting joint performance.
Damage (7000)	None.	The element has minor damage caused by vehicular or vessel impact.	The element has moderate damage caused by vehicular or vessel impact.	The element has severe damage caused by vehicular or vessel impact.

CS TABLE 8 – JOINTS (Continued)



Condition State 2



Condition State 3

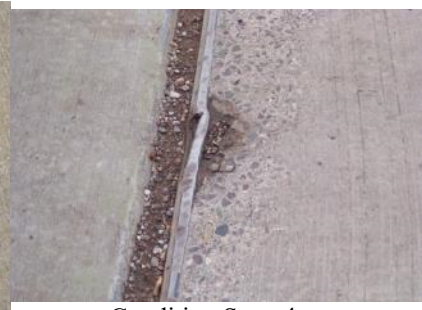

Condition State 4



Condition State 2



Condition State 3



Condition State 4



Condition State 2



Condition State 3



Condition State 4

CS TABLE 8 – JOINTS – DEFECT SPECIFIC PHOTOGRAPHS



(2330 – Seal Damage)
Condition State 2



(2330 – Seal Damage)
Condition State 3

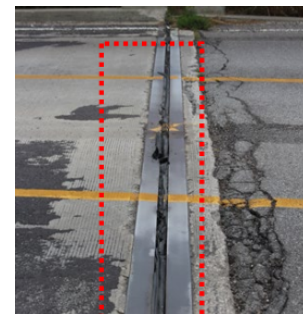

(2330 – Seal Damage)
Condition State 4

CS TABLE 8 – JOINTS – DEFECT SPECIFIC PHOTOGRAPHS (Continued)

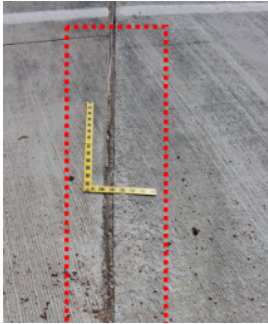

(2350 – Debris Impaction)
Condition State 2

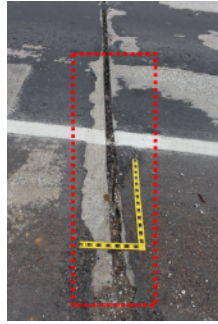

(2350 – Debris Impaction)
Condition State 3



(2350 – Debris Impaction)
Condition State 4

CS TABLE 9 – BEARINGS

	Condition State 1	Condition State 2	Condition State 3	Condition State 4
Defects	GOOD	FAIR	POOR	SEVERE
Corrosion (1000)	None.	Freckled rust. Corrosion of the steel has initiated.	Section loss is evident or pack rust is present but does not warrant structural review.	The condition warrants a structural review to determine the effect on strength or serviceability of the element or bridge; OR a structural review has been completed and the defects impact strength or serviceability of the element or bridge. The element has severe damage caused by vehicular or vessel impact.
Connection (1020)	Connection is in place and functioning as intended.	Loose fasteners or pack rust without distortion is present but the connection is in place and functioning as intended.	Missing bolts, rivets, or fasteners; broken welds; or pack rust with distortion but does not warrant structural review.	
Movement (2210)	Free to move.	Minor restriction.	Restricted but not warranting structural review.	
Alignment (2220)	Lateral and vertical alignment is as expected for the temperature conditions.	Tolerable lateral or vertical alignment that is inconsistent with the temperature conditions.	Approaching the limits of lateral or vertical alignment for the bearing but does not warrant a structural review.	
Bulging, Splitting or Tearing (2230)	None	Bulging less than 15% of the thickness.	Bulging 15% or more of the thickness. Splitting or tearing. Bearing's surfaces are not parallel. Does not warrant structural review.	
Loss of Bearing Area (2240)	None.	Loss of less than 10%.	Loss of 10% or more but does not warrant a structural review.	
Damage (7000)	Not applicable.	The element has minor damage caused by vehicular or vessel impact.	The element has moderate damage caused by vehicular or vessel impact.	

CS TABLE 9 – BEARINGS (Continued)



Condition State 2



Condition State 3



Condition State 4



Condition State 2



Condition State 3

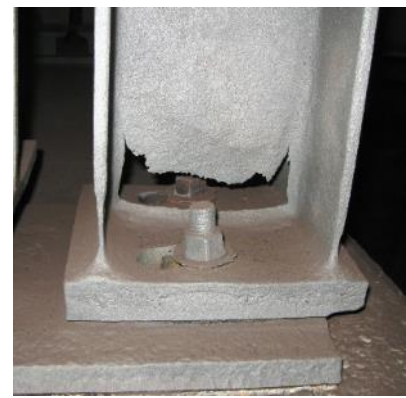

Condition State 4

CS TABLE 9 – BEARINGS – DEFECT SPECIFIC PHOTOGRAPHS



(2220 – Alignment)
Condition State 1



(2220 – Alignment)
Condition State 2

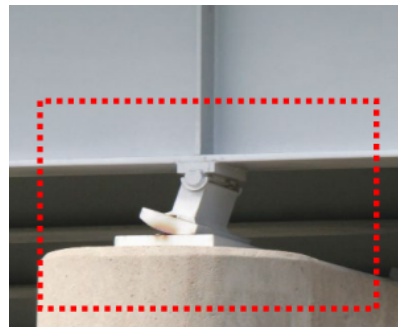

(2220 – Alignment)
Condition State 3



(2240 – Loss of Bearing Area)
Condition State 2



(2240 – Loss of Bearing Area)
Condition State 3

CS TABLE 10 – PROTECTIVE SYSTEMS

	Condition State 1	Condition State 2	Condition State 3	Condition State 4
Defects	GOOD	FAIR	POOR	SEVERE
Chalking - Steel Protective Coatings (3410)	None.	Surface dulling.	Loss of pigment.	Not applicable.
Peeling/Bubbling/ Cracking - Steel Protective Coatings (3420)	None.	Finish coats only.	Finish and primer coats.	Exposure of bare metal.
Oxide Film Degradation Color/ Texture Adherence – Steel Protective Coatings (3430)	Yellow-orange or light brown for early development. Chocolate-brown to purple-brown for fully developed. Tightly adhered, capable of withstanding hammering or vigorous wire brushing.	Granular texture.	Small flakes, less than 1/2 in. diameter.	Dark black color. Large flakes, 1/2 in. diameter or greater or laminar sheets or nodules.
Effectiveness - Steel Protective Coatings (3440)	Fully effective.	Substantially effective.	Limited effectiveness.	Failed. No protection of the underlying metal.
Wear - Concrete Protective Coatings (3510)	None.	Underlying concrete not exposed. Coating showing wear from UV exposure. Friction course missing.	Underlying concrete is not exposed and thickness of the coating is reduced.	Underlying concrete exposed. Protective coating no longer effective.
Effectiveness - Concrete Protective Coatings (3540)	Good condition. Fully effective.	Substantially effective.	Limited effectiveness.	The protective system has failed or is no longer effective.
Effectiveness - Protective System [e.g. cathodic, scour monitoring] (3600)	Fully effective.	Substantially effective.	Limited effectiveness.	The protective system has failed or is no longer effective.
Damage (7000)	Not applicable.	The element has minor damage caused by vehicular or vessel impact.	The element has moderate damage caused by vehicular or vessel impact.	The element has severe damage caused by vehicular or vessel impact.



Condition State 2



Condition State 3



Condition State 4

CS TABLE 10 – PROTECTIVE SYSTEMS (Continued)



Condition State 2



Condition State 3



Condition State 4

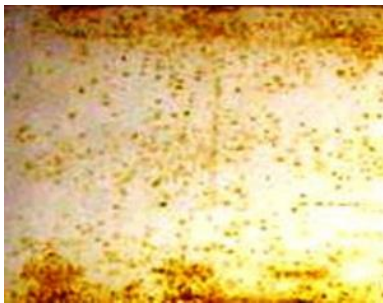

Condition State 2



Condition State 3



Condition State 4

CS TABLE 10 – PROTECTIVE SYSTEMS – DEFECT SPECIFIC PHOTOGRAPHS



(3410 – Chalking)
Condition State 2

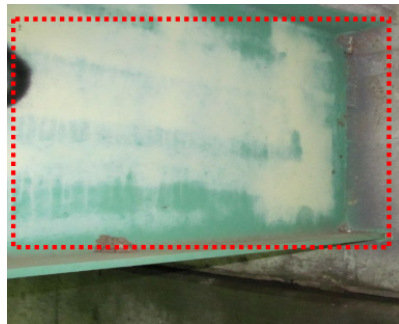

(3410 – Chalking)
Condition State 3

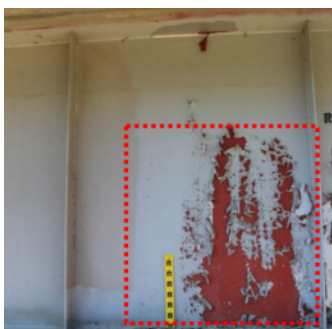

(3420 – Peeling/Bubbling/Cracking)
Condition State 2



(3420 – Peeling/Bubbling/Cracking)
Condition State 3



(3420 – Peeling/Bubbling/Cracking)
Condition State 4

**CS TABLE 10 – PROTECTIVE SYSTEMS – DEFECT SPECIFIC PHOTOGRAPHS
(Continued)**

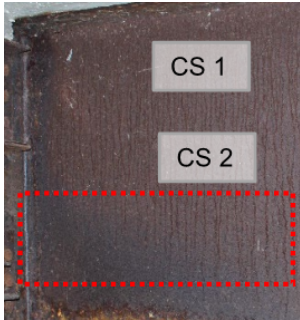

(3430 – Oxide Film Degradation)
Condition State 2



(3430 – Oxide Film Degradation)
Condition State 3



(3430 – Oxide Film Degradation)
Condition State 3



(3440 – Effectiveness)
Condition State 2



(3440 – Effectiveness)
Condition State 3



(3440 – Effectiveness)
Condition State 4

11. DEFECT HIERARCHY

Defects will often coincide, either overlapping or one next to another in the same area; a typical example of the former would be exposed rebar in a spall and the latter would be a one foot section of a girder with cracking and a spall, but the cracking does not run through the spall. In both cases this one foot area cannot be counted twice, since that would result in two feet of defects where there is only one foot of element.

In cases where defects coincide, only one defect can be reported. The following will assist the inspector in determining which defect should be assigned to the subject area. In such areas, where there are two or more overlapping defects, the worse condition takes precedence. If the worst defect in an area is in Condition State 3, then that portion of the element is in Condition State 3, regardless of how many other Condition State 2 defects share that space.

For cases where there are multiple defects in an area with the same condition state and therefore no worse condition state, a defect hierarchy is used (i.e., a “tie”). SCDOT has created a hierarchy to aid inspectors in assigning a defect in such situations. This hierarchy should be viewed as a guideline in deciding which defect is the most “important” in any given situation, not as a set of hard and fast rules. Ultimately, inspectors must use their own judgment.

One thing to keep in mind in selecting a controlling defect in a tie is the relative extent of the defects over the element. An example would be a situation where there is a steel girder with cracking and corrosion defects, both in Condition State 3. The cracking occurs in the last foot of the element, the corrosion over the last 10 feet. The two defects occur together only in the last foot. If the inspector decides corrosion controls, then 10 feet of Condition State 3 corrosion is reported and the cracking is not reported at all. If the inspector decides cracking controls, 9 feet of Condition State 3 corrosion and one foot of Condition State 3 cracking are reported. The second solution may be more suitable.

Elements with a unit of “Each” are handled differently. “Each” elements are viewed as a group of indivisible individuals. For example, with columns there can be one or two columns; there cannot be 1.5 columns. Each individual column is entirely in one and only one condition state. Each column can have one and only one defect assigned to the Element. If two Condition State 3 defects occur on an individual column, only one can be reported, regardless of the relative extent of the two defects. The inspector will need to decide which the bigger “threat” for that column is and report that defect on that column.

For example, take an interior bent with four reinforced concrete piles, which are inspected and found to be in the following conditions:

Column 1

Good Condition

Column 2

Good Condition

Column 3

Widespread spalls which are 0.5 inches deep and about 4 inches in diameter. (Condition State 3)

A large amount of cracking (approximately 0.012 inches wide) from top to bottom of the pile. (Condition State 2)

Column 4

Minimal amount of spalls which are over 1.5 inches deep and larger in diameter than 8 inches. (Condition State 2)

Extensive cracking (over 0.05 inches wide) along the full length of pile and very concentrated at the pile top. (Condition State 3)

Totals Reported for Element Inspection

Condition State 1 (CS1) = 2 EA (Columns 1 and 2)

Condition State 2 (CS2) = 1 EA (Column 4, spalling (CS2) controls over cracking (CS3))

Condition State 3 (CS3) = 1 EA (Column 3, spalling (CS3) controls over cracking (CS2))

All of the conditions must be reported in the textual section of the inspection report. As stated previously, inspectors must use their own judgment and use this only as a variable guide.

The following are the defects noted in hierarchy format to assist the inspector in determining which defect may take precedence over another when the condition states of two different defects for the same element are equal. As stated previously, inspectors must use their own judgment and use this only as a variable guide.

REINFORCED CONCRETE

Decks

- 1090 – Exposed Concrete Rebar
- 1080 – Delamination/Spall/Patched Area
- 1120 – Efflorescence/Rust Staining
- 1130 – Cracking
- 7000 – Damage
- 1190 – Abrasion/Wear

Superstructure

- 7000 – Damage
- 1900 – Distortion
- 1090 – Exposed Concrete Rebar
- 1080 – Delamination/Spall/Patched Area
- 1120 – Efflorescence/Rust Staining
- 1130 – Cracking

Substructure

- 7000 – Damage
- 1900 – Scour
- 4000 – Settlement
- 1090 – Exposed Concrete Rebar
- 1080 – Delamination/Spall/Patched Area
- 1120 – Efflorescence/Rust Staining
- 1130 – Cracking
- 1190 – Abrasion/Wear

PRESTRESSED CONCRETE

Decks

- 1100 – Exposed Prestressing
- 1090 – Exposed Concrete Spalls/Delaminations Rebar
- 1080 – Delamination/Spall/Patched Area
- 1120 – Efflorescence/Rust Staining
- 1110 – Cracking
- 7000 – Damage
- 1190 – Abrasion

Superstructure

- 7000 – Damage
- 1100 – Exposed Prestressing
- 1090 – Exposed Concrete Rebar
- 1080 – Delamination/Spall/Patched Area
- 1120 – Efflorescence/Rust Staining
- 1110 – Cracking

Substructure

- 7000 – Damage
- 6000 – Scour
- 4000 – Settlements
- 1100 – Exposed Prestressing
- 1090 – Exposed Concrete Rebar
- 1080 – Delamination/Spall/Patched Area
- 1120 – Efflorescence/Rust Staining
- 1110 – Cracking
- 1190 – Abrasion/Wear

TIMBER**Decks**

- 1140 – Decay/Section Loss
- 7000 – Damage
- 1180 – Abrasion/Wear
- 1160 – Cracks
- 1170 – Split/Delamination
- 1020 – Connections
- 1150 – Check/Shake
- 1180 – Abrasion/Wear

Superstructure

- 7000 – Damage
- 1140 – Decay/Section Loss
- 1160 – Cracks
- 1170 – Split/Delamination
- 1020 – Connections
- 1150 – Check/Shake
- 1180 – Abrasion/Wear

Substructure

- 6000 – Scour
- 4000 – Settlement
- 1140 – Decay/Section Loss
- 7000 – Damage
- 1180 – Abrasion/Wear
- 1160 – Cracks
- 1170 – Split/Delamination
- 1150 – Check/Shake
- 1020 – Connections

JOINTS

- 2310 – Leakage
- 2320 – Seal Adhesion
- 2370 – Metal Deterioration or Damage
- 2330 – Seal Damage
- 2340 – Seal Cracking
- 2360 – Adjacent Deck or Header
- 7000 – Damage
- 2350 – Debris Impact

STEEL (ALL ELEMENTS)

- 6000 – Scour (Substructure Only)
- 4000 – Settlement (Substructure Only)
- 1010 – Cracking
- 1020 – Connection
- 1900 – Distortion
- 1000 – Corrosion
- 7000 – Damage

STEEL PROTECTIVE COATING

- 7000 – Damage
- 3440 – Effectiveness (Steel Protective Coatings) – Beam/Girder End Protective Coating Steel
- 3420 – Peeling/Bubbling/Cracking (Steel Protective Coatings) – Beam/Girder End Protective Coating Steel
- 3410 – Chalking (Steel Protective Coatings) – Beam/Girder End Protective Coating Steel
- 3430 – Oxide Film Duration Color/Texture Adherence (Steel Protective Coatings) – Beam/Girder End Protective Coating Steel

CONCRETE PROTECTIVE COATING

- 7000 – Damage
- 3540 – Effectiveness (Concrete Protective Coatings) – Beam/Girder End Protective Coating Concrete
- 3510 – Wear (Concrete Protective Coatings) – Beam/Girder End Protective Coating Concrete

MASONRY (ALL ELEMENTS)

- 6000 – Scour
- 4000 – Settlement
- 7000 – Damage
- 1640 – Masonry Displacement
- 1080 – Spalls/Delaminations/Patches
- 1620 – Split/Spall
- 1630 – Patched Area
- 1610 – Mortar Breakdown
- 1900 – Distortion
- 1120 – Efflorescence/Rust Staining

OTHER (ALL ELEMENTS)

- 6000 – Scour (Substructure Only)
- 4000 – Settlement (Substructure Only)
- 1900 – Distortion
- 7000 – Damage
- 1010 – Cracking
- 1020 – Connection
- 1220 – Deterioration
- 1120 – Efflorescence/Rust Staining
- 1080 – Spalls/Delaminations/Patches
- 1130 – Cracking
- 1000 – Corrosion

BEARINGS (ALL ELEMENTS)

- 7000 – Damage
- 2220 – Alignment

- 2210 – Movement
- 2240 – Loss of Bearing Area
- 2230 – Bulging/Splitting/Tearing
- 4000 – Settlement
- 1020 – Connection
- 1000 – Corrosion

WEARING SURFACES

- 3230 – Effectiveness (Wearing Surface)
- 3210 – Delaminations/Spall/Patched Area/Pothole (Wearing Surface)
- 3220 – Crack (Wearing Surface)
- 7000 – Damage

12. ADDITIONAL GUIDANCE ON ELEMENT QUANTITIES

GIRDERS/STRINGERS/FLOOR BEAMS

The figure below shows a two-girder bridge that is 50 feet long with three floorbeams that are 25 feet long each and five stringers.

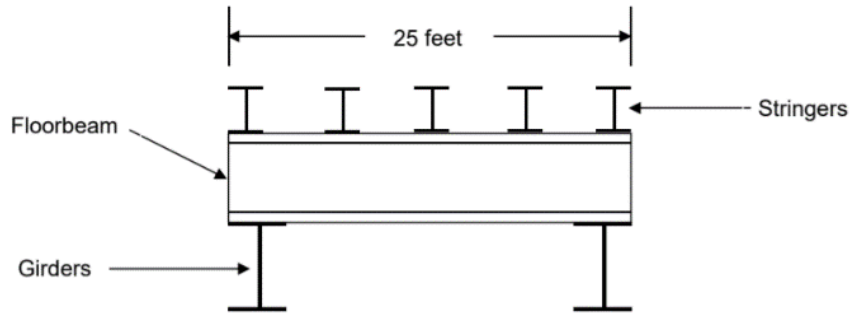

Element #	Element Name	Quantity
107	Steel Open Girder/Beam	100 LF (2 x 50)
113	Steel Stringer	250 LF (5 x 50)
152	Steel Floor Beam	75 LF (3 x 25)

PRESTRESSED CONCRETE CLOSED WEB/BOX GIRDERS

Element 104 is for both voided and unvoided Prestressed Concrete Girders/Slabs. These slabs should be coded as Element 104 - Prestressed Concrete Closed Web/Box Girders. A top flange Element is also needed. If there is a separate wearing surface it must also be coded so the riding surface can be assessed. Where the girders are not spread and the traffic rides directly on the structural element, regardless of the wearing surface, evaluation of the top flange is considered with element 15- Prestressed Concrete Top Flange or 16-Reinforced Concrete Top Flange. This configuration will NOT typically have a separate deck element.

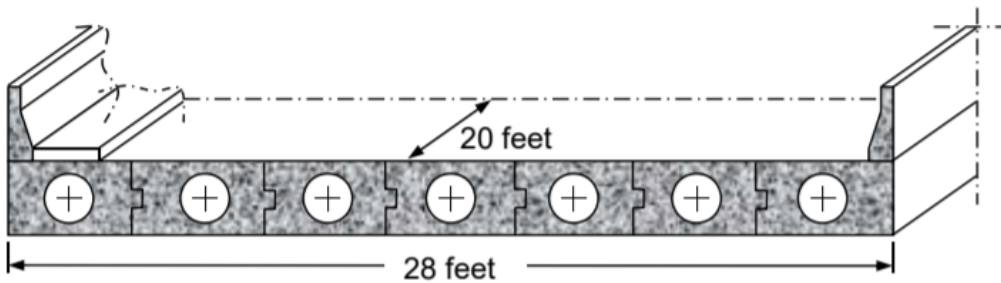

Element #	Element Name	Quantity
104	Prestressed Concrete Closed Web/Box Girders	140 LF (7 x 20)
15	Prestressed Concrete Top Flange	560 SF (20 x 28)
801	Sidewalk	20 SF (1 x 20)
510	Wearing Surface	560 SF (20 x 28)

SLAB SPANS COVERED WITH FILL

This element also applies to Concrete Deck Arches covered with fill. Even though these structures are covered with fill, deck, superstructure, and substructure elements should be defined as appropriate. Element 65 should be used to report the condition of the slab. All or part of the top surface will not be visible for inspection, therefore the Element shall be assessed based on the available visible surface, top and/or bottom of the slab. If both top and bottom surfaces are not visible, the condition shall be assessed based on destructive and/or nondestructive testing or indicators in the materials covering the surfaces. Information from other sources may be helpful in coding this Element.

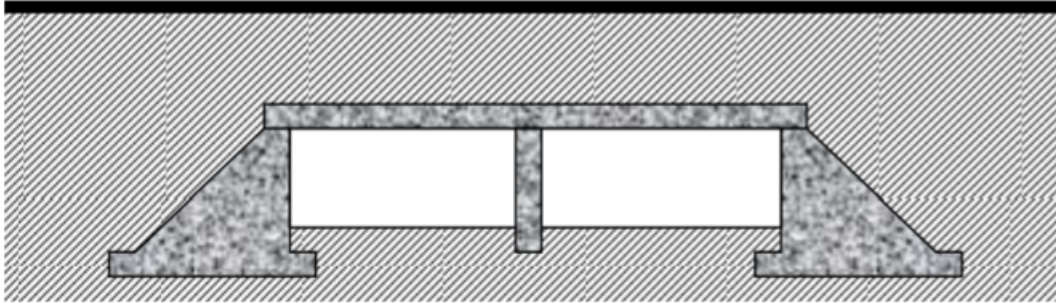

Element #	Element Name	Quantity
65	Other Slab	Area in SF
215	Reinforced Concrete Abutment	Length in LF
210	Reinforced Concrete Pier Wall	Length in LF

TRUSSES

Determining Quantities

The superstructure of a truss bridge usually consists of two parallel trusses. The quantity is determined by calculating the combined length in linear feet of the parallel trusses. Diagonals, verticals, or cross bracing are not counted as additional quantities.

Total Length

The overall quantity is determined by the length of the bridge multiplied by the number of trusses in each span. See example below.

Deck Truss

Note: Both Through and Deck trusses are coded using the same Element depending on the material type. The following example is a steel deck truss. Also note the bottom chords are no longer a separate element for through trusses.

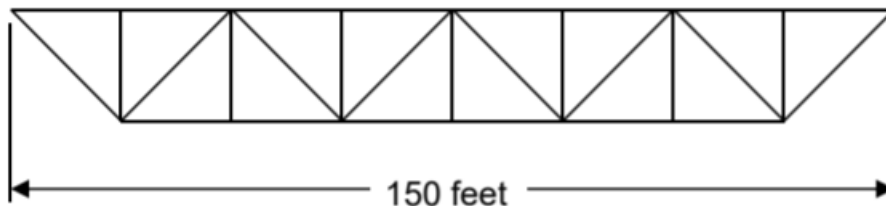

Element #	Element Name	Quantity
120	Steel Truss (Regardless of type and protective system/paint)	300 LF (2 x 150)

Through Trusses (includes Pony Trusses)

The following example is for a steel through truss. Note the bottom chords are no longer a separate element for through trusses.

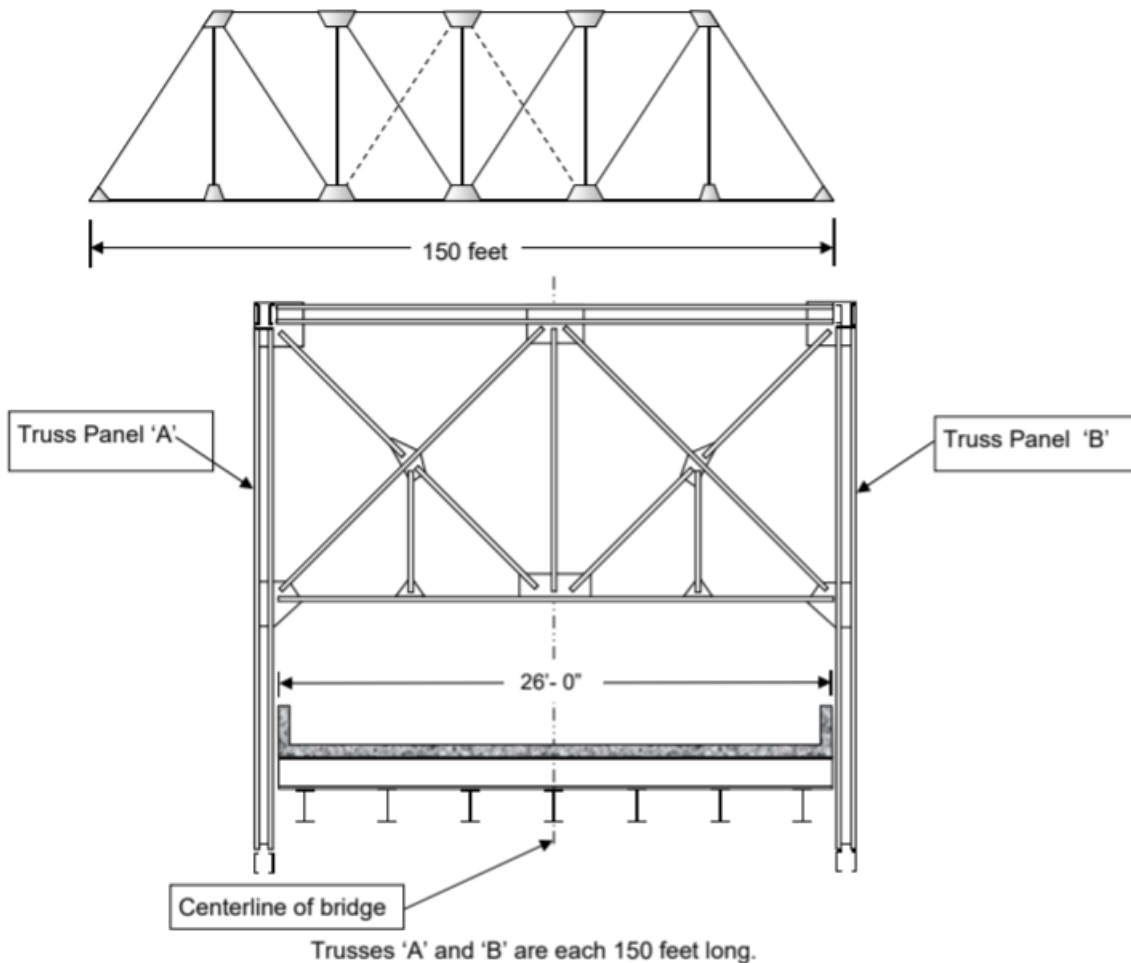

Element #	Element Name	Quantity
12	Reinforced Concrete Deck	3900 LF (150 x 26)
113	Steel Stringer	1050 LF (7 x 150)
120	Steel Truss	300 LF (2 x 150)
162	Steel Gusset Plate	24 EA (2 x 12)
152	Steel Floorbeam	182 LF (7 x 26)

The length of the floor beam shown in this example is for illustration purposes only. The actual length of the floor beam should be measured in the field or determined from the plans. The above is not meant to signify all the Elements required for the structure above.

Deterioration

All deterioration is measured along the length of the bridge.

Diagonals

Deterioration of a diagonal member is measured along the length of the bridge and not along the diagonal. The quantity of a deteriorated section in diagonals and verticals that overlap deteriorated section(s) in other parts of the truss should not be double-counted. See example below.

Portals/Bracing

The quantities of deterioration of portals/bracing should be counted with the truss element. The quantity of a deteriorated section in portals/bracing that overlaps a deteriorated section(s) in other parts of the truss, with which it has been associated, should not be double-counted. The darkened areas in the sketch below indicate areas of deterioration on a member.

Through Truss (includes Pony Trusses)

The following example is a steel through truss. Quantities of deterioration should include both the left and right side trusses. Note that the deterioration should be measured along the horizontal projection. The severity of the deterioration is indicated by using the appropriate condition state. The quantities listed are the deteriorated portions of the truss.

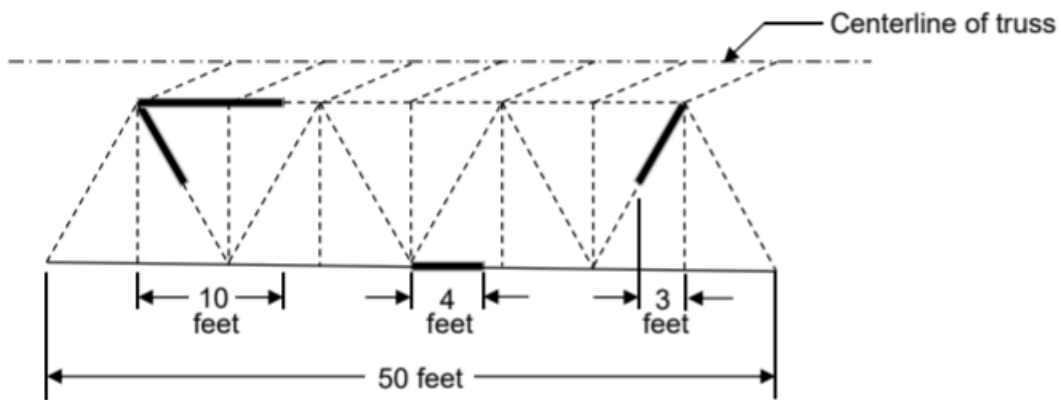

Element #	Element Name	Quantity	Deterioration
120	Steel Truss	100 LF (2 x 50)	17 LF (10 + 4 + 3)

13. SCOUR DEFECT

Scour is defined as erosion or removal of streambed or bank material around substructure or foundation elements due to river or stream flow. Erosion of embankment material due to roadway runoff is not scour, and will not carry a scour defect.

The scour defect is only applied to the lowest exposed element at a support.

The following are definitions for Condition States 1 to 4 when using this section:

Conditions for which the scour defect is not used:

- Minor observed local scour around supports, typical of supports with silt and sandy soils.
- The channel bed elevations are close to as-built conditions.
- There are no exposed footings or the exposed footings are founded on non-erodible bedrock as determined by a structural review.
- Defects are not applied in CS1.

Condition State 2

- Observed scour is greater than the minor conditions noted above but less than the maximum column or pile lengths noted in this section.
- Scour is within the limits of a spread footing.
- Scour has been arrested with effective countermeasures.

Condition State 3

- Scour exceeds the maximum lengths noted in this section or is undermining
- A spread footing but a structural review has found that the condition does not affect the strength or serviceability of the structure.

Condition State 4

- Scour exceeds the maximum lengths noted in this section and a structural review is not yet completed or, a structural review has been completed and
- The scour impacts the strength or serviceability of the structure.
- Need for a Re-evaluation of Item 113 (Bridge Scour), Attachment 4.2
- SCDOT HQ will determine the stability of the structure. The scour assessment shall recommend the appropriate mitigation and condition state, either CS3 or CS4 when no countermeasures are in place or CS 2 when effective scour countermeasures are in place. When the scour assessment is not completed prior to the required time frame for report submittal, CS4 shall be used until the review has been completed.

SCOUR DEFECT CODING FOR SPREAD FOOTINGS

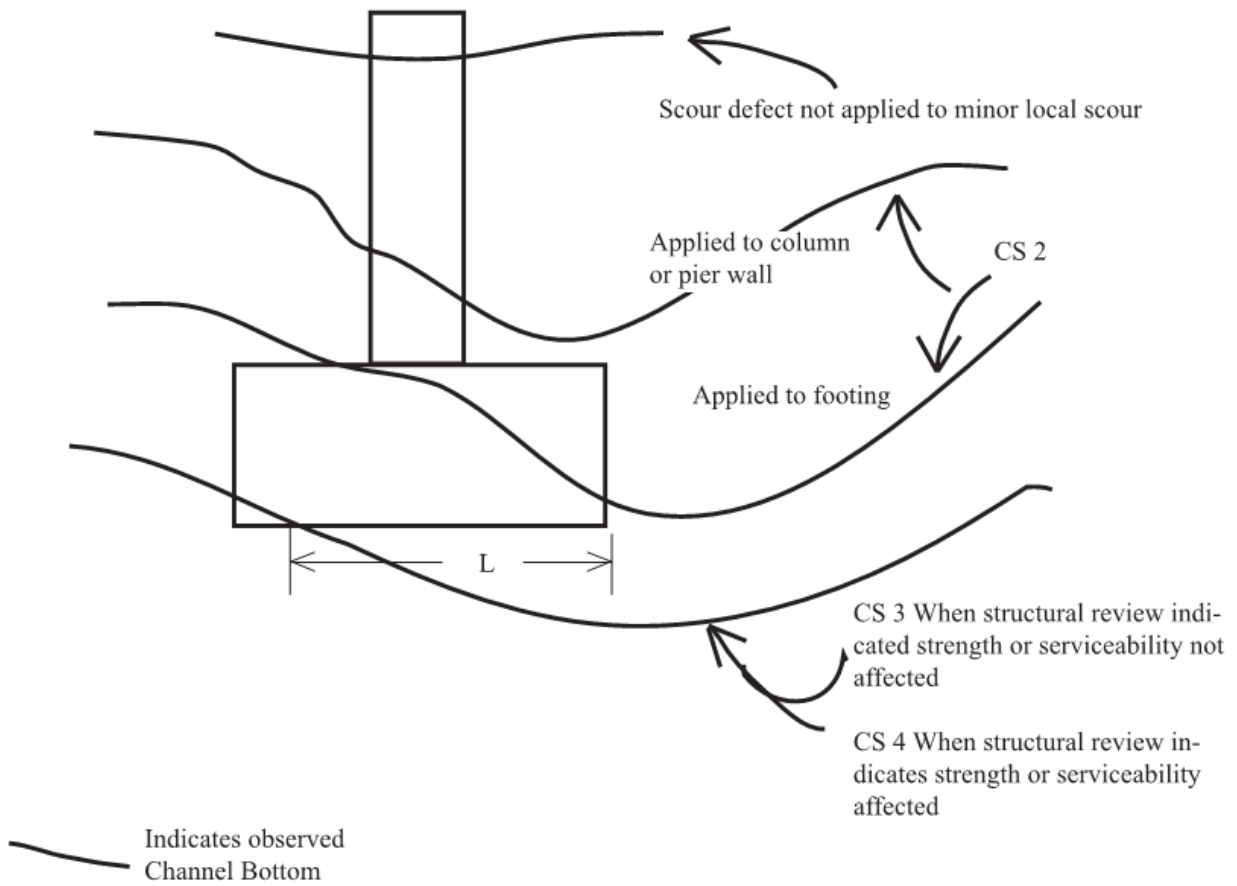

- Any undermined spread footing requires a structural review.
- The scour defect is not used for an exposed footing founded on non-erodable rock with no or insignificant undermining. A structural review should determine that the rock is non-erodable.
- The scour defect is applied to the length of undermined footing.

SCOUR DEFECT CODING FOR STEEL/CONCRETE PILES UNDER PILE CAP

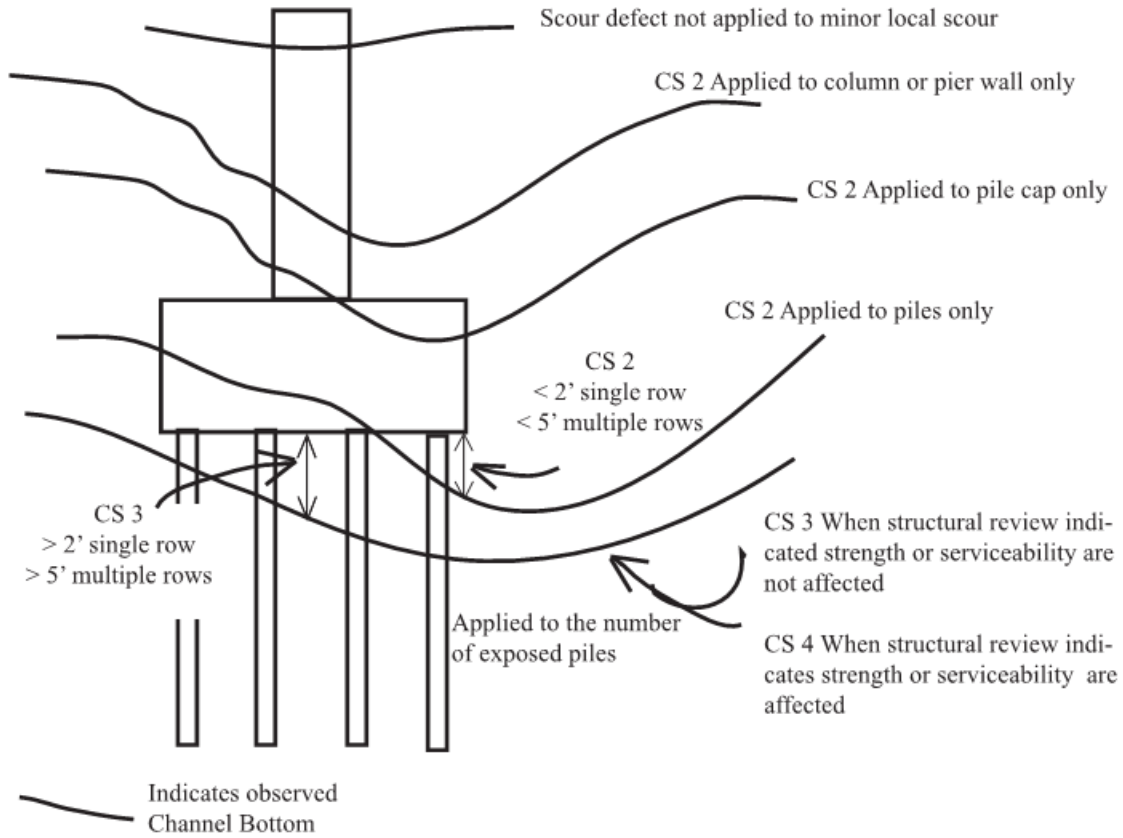

- Steel or concrete piles under a pile cap with an exposed length greater than 2 feet for a single row or 5 feet for multiple rows require a structural review.
- The scour defect is applied to the length of affected exposed pile cap or the number of exposed piles.

SCOUR DEFECT CODING FOR TIMBER PILES UNDER PILE CAP

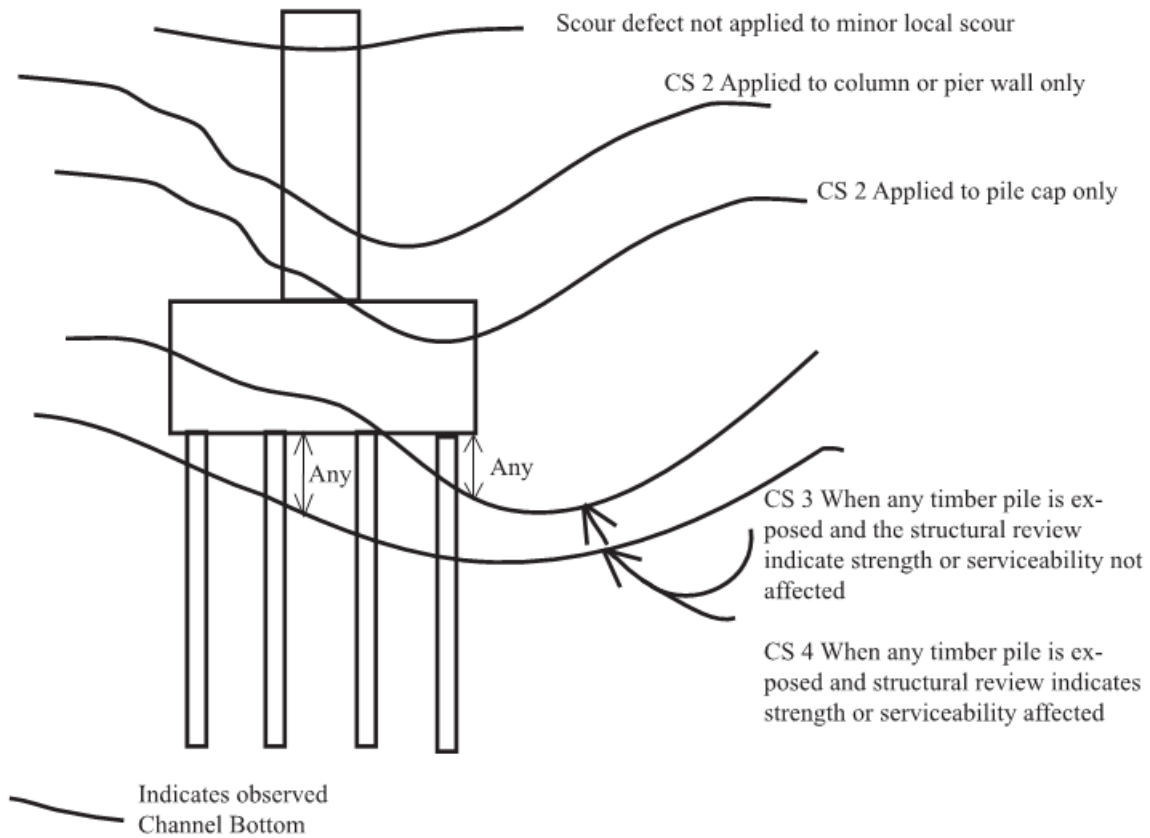

- Any exposed timber pile under a pile cap requires a structural review.
- The scour defect is applied to the length of affected footing or the number of exposed piles.

SCOUR DEFECT CODING FOR STEEL/CONCRETE BENT

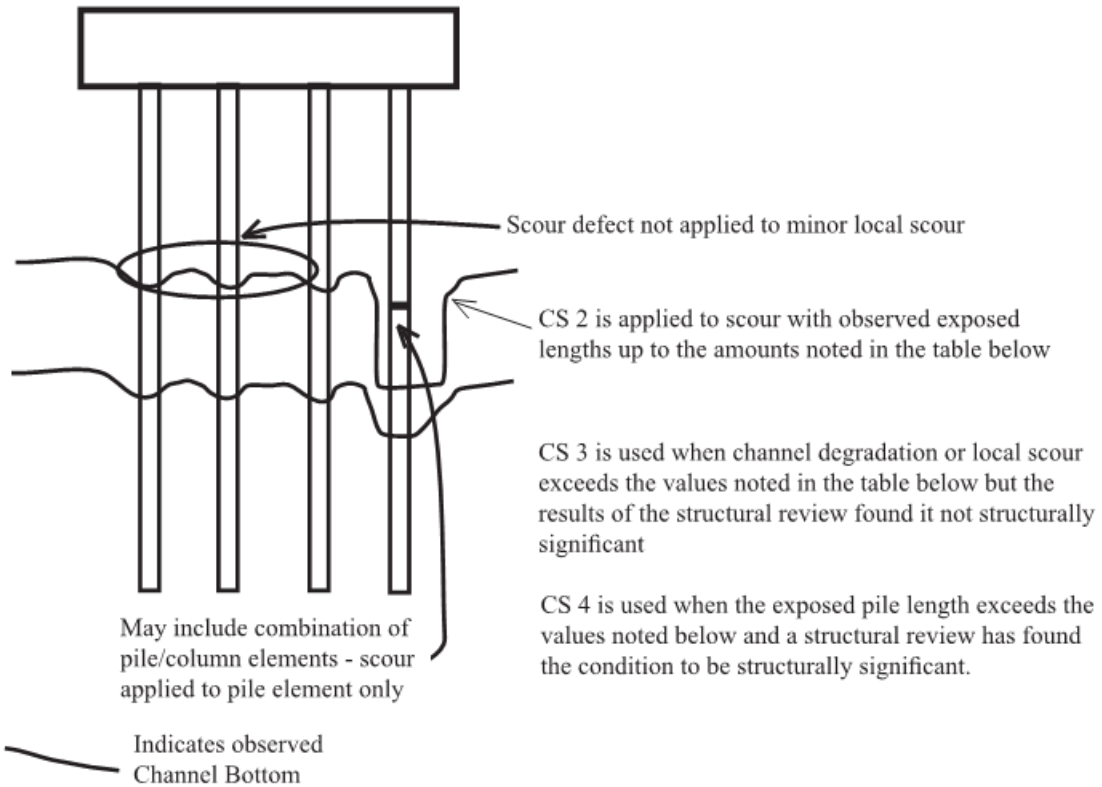

- Steel or concrete piles, pile extensions, and CISS piles with exposed pile lengths exceeding those shown below require a structural review.
- The scour defect is applied to the number of piles in each condition state.

Maximum Exposed Length of Steel and Concrete columns or combined pile/column length when a pile has been extended with a column	
<u>Column Diameter (Inches)</u>	<u>Maximum Observed Unbraced Length (feet)</u>
12	22
15	26
18	34
20	38

SCOUR DEFECT CODING FOR TIMBER BENT

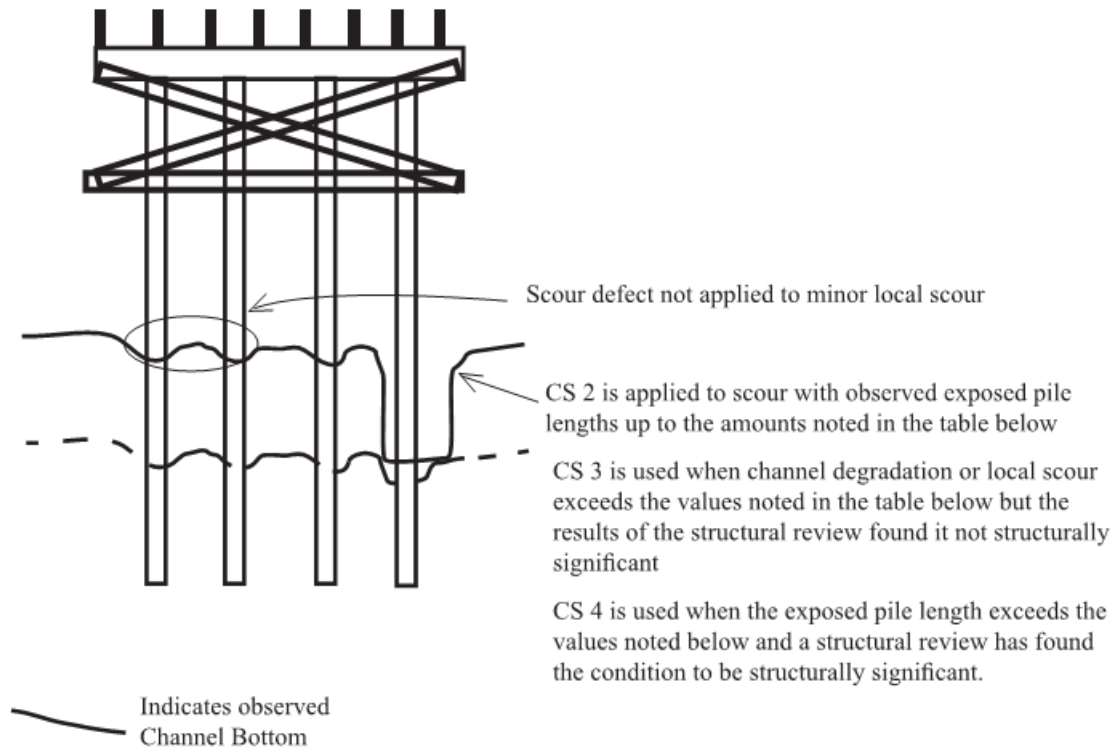

- Timber piles with exposed pile lengths exceeding those shown below require a structural review.
- The scour defect is applied to the number of piles in each condition state.

Maximum Exposed Length of Timber Piles in Bents	
<u>Column Diameter (Inches)</u>	<u>Maximum Observed Unbraced Length (feet)</u>
12	13
15	17